



U.S. Department
of Transportation
**National Highway
Traffic Safety
Administration**



DOT HS 812 610

September 2018

Development of Fit Envelopes To Promote Compatibility Among Vehicles and Child Restraint Systems

DISCLAIMER

This publication is distributed by the U.S. Department of Transportation, National Highway Traffic Safety Administration, in the interest of information exchange. The opinions, findings, and conclusions expressed in this publication are those of the authors and not necessarily those of the Department of Transportation or the National Highway Traffic Safety Administration. The United States Government assumes no liability for its contents or use thereof. If trade or manufacturers' names or products are mentioned, it is because they are considered essential to the object of the publications and should not be construed as an endorsement. The United States Government does not endorse products or manufacturers.

Suggested APA Format Citation:

Klinich, K. D., Boyle, K. J., Malik, L. J., Manary, M. A., Eby, B. J. & Hu, J. (2018, September). *Development of fit envelopes to promote compatibility among vehicles and child restraints* (Report No. DOT HS 812 610). Washington, DC: National Highway Traffic Safety Administration.

Technical Report Documentation Page

1. Report No. DOT HS 812 610		2. Government Accession No.		3. Recipient's Catalog No.	
4. Title and Subtitle Development of Fit Envelopes to Promote Compatibility Among Vehicles and Child Restraints			5. Report Date September 2018		
			6. Performing Organization Code		
7. Authors Klinich, Kathleen D., Boyle, Kyle J., Malik, Laura J., Manary, Miriam A., Eby, Brian J., Hu, Jingwen			8. Performing Organization Report No. UMTRI-2015-24		
9. Performing Organization Name and Address University of Michigan Transportation Research Institute 2901 Baxter Rd. Ann Arbor MI 48109			10. Work Unit No. (TRAIS)		
			11. Contract or Grant No.		
12. Sponsoring Agency Name and Address National Highway Traffic Safety Administration 1200 New Jersey Avenue SE. Washington, DC 20590			13. Type of Report and Period Covered Final, January 2014-August 2015		
			14. Sponsoring Agency Code		
15. Supplementary Notes					
16. Abstract This project developed fit envelopes representing the space occupied by small, medium, and large rear-facing and forward-facing child restraints that can be used as tools for promoting compatibility between vehicles and child restraints. The approach applies the envelope method used by the International Standards Organization (ISO) to the U.S. market, by considering the range of child restraint sizes in the 2014 U.S. market and the more commonly used method of installation with flexible Lower Anchors and Tethers for Children (LATCH). Thirty-one child restraints representing a range of sizes, manufacturers, and product types were scanned and installed in vehicles. The installed positions of the child restraints were measured in 10 late-model vehicles. A comparison of the installed positions of the child restraints in vehicles was done virtually using Hypermesh. Starting with the envelope geometries used by the ISO, envelope shapes were modified to represent small, medium, and large rear-facing and forward-facing child restraints. When possible, envelope dimensions were harmonized with the ISO envelopes. To promote compatibility, child restraints should be able to fit in one or more applicable envelopes at an acceptable orientation when the envelope is rotated 15° relative to horizontal (to represent installed orientations on a typical vehicle seat cushion angle). To promote compatibility from the vehicle side, at least one rear-facing and one forward-facing envelope should be able to be installed in each vehicle rear seating position. Although the evaluation of fit can be performed virtually using computer-aided design, physical representations of the envelopes were also constructed. Four sets of nesting boxes were built. For child restraint evaluation, the largest rear-facing and forward-facing envelope geometry can be modified with foam inserts to represent the medium and smaller sizes. For vehicle evaluation, a wooden base is installed in the vehicle using flexible LATCH belts. Different components are added to represent the small, medium, and large sizes. Test procedures have been drafted to describe setup of vehicles, child restraints, and the evaluation process.					
17. Key Word misuse, child restraint installation, child restraint volumes, compatibility			18. Distribution Statement This document is available to the public through the National Technical Information Service, www.ntis.gov .		
19. Security Classif. (of this report)		20. Security Classif. (of this page)		21. No. of Pages 126	22. Price

Form DOT F 1700.7 (8-72)

Reproduction of completed page authorized

TABLE OF CONTENTS

List of Figures	iii
List of Tables	v
Acknowledgments.....	vi
Introduction	1
Motivation.....	1
ISO Fit Envelopes.....	2
Objectives and Approach	2
Methods	4
Child Restraint Selection	4
Vehicle Selection Process.....	12
Test Matrix	15
Scan and Orientation Measurements	17
Envelope Design Process.....	19
Results	24
Initial Proposed Designs.....	24
First Prototype Evaluation	33
Revised Designs.....	37
Final Designs	42
Discussion	52
References	54
Appendix A: Photos of Physical Envelopes	A-1
Appendix B: Envelope Testing Instructions	B-1
Appendix C: CRS in Envelopes.....	C-1
Appendix D: Envelopes in Vehicles	D-1

LIST OF FIGURES

Figure 1.	Example of a rear-facing CRS and its scanned geometry.	17
Figure 2.	Example of geometry from a vehicle scan.	18
Figure 3.	Example of CRS geometry positioned relative to seating position using reference coordinates.	19
Figure 4.	Installed RF CRS positions in four vehicles compared to the ISO R3 envelope.	20
Figure 5.	Envelope design that fits around RF CRS.	20
Figure 6.	Placement of preliminary envelope in a sample vehicle.	21
Figure 7.	Lower gap too large (greater than 100 mm)	21
Figure 8.	Upper gap too large (greater than 50 mm)	22
Figure 9.	Lower gap acceptable (less than 100 mm)	22
Figure 10.	FF CRS installations in four vehicles compared to the ISO F3 envelope.	23
Figure 11.	ISO F3 envelope “stretched” to fit around acceptable FF CRS installations in four vehicles. .	23
Figure 12.	Revised proposal to develop long (left) and tall (right) RF CRS.	24
Figure 13.	Comparison of proposed long (red), tall (blue), and large (green) envelopes.	25
Figure 14.	ISO R1 compared to three estimated installed profile of shell portion of a RF CRS.	25
Figure 15.	Proposals for FF envelopes: FS (yellow), FM (orange), FL (red).	26
Figure 16.	Angle versus distance of belt path contact location to LA for RF 2L and 2C installations by vehicle type.	27
Figure 17.	Angle versus distance of belt path contact location to LA for RF 2L and 2C installation by CRS manufacturer.	28
Figure 18.	Angle versus distance of belt path contact location to LA for FF 2L and 2C installations by vehicle type.	29
Figure 19.	Angle versus distance of belt path contact location to LA for FF 2L and 2C installation by CRS manufacturer.	29
Figure 20.	Drawing of attachment points and belt path corridors for RF envelope.	31
Figure 21.	Drawing of attachment points and belt path corridors for FF envelope.	32
Figure 22.	Tether location that can be used with all three envelopes representing common attachment location marked with X.	33
Figure 23.	Initial RM prototype.	33
Figure 24.	Example of RF-only CRS that would fit with carry handle in upright position if lid was used.	35
Figure 25.	Examples of different level indicators.	35
Figure 26.	Examples of different recline levels for different child weights.	36
Figure 27.	One CRS did not fit with fabric covers in place (left) but did when covers over side elements were shifted (right).	36
Figure 28.	Some CRS did not contact the bottom of the envelope.	36
Figure 29.	Concept for reconfigurable RF _{CRS} envelope; drawing with dashed line indicates lateral extent of envelope.	38
Figure 30.	FF _{veh} base (green) plus two components added to create FS.	39

Figure 31. FF _{veh} base (green) plus four components to create FM, and one more component to create FL.	39
Figure 32. Original proposed design of FS envelope falls outside space occupied by U.S. CRS and could cause issues placing in rear seat.	40
Figure 33. RF CRS geometries overlaid with envelopes. Dashed line indicates modification to shorten bottom envelope dimension.	41
Figure 34. FF CRS geometries overlaid with envelopes. Dashed line indicates modification to shorten bottom envelope dimension.	41
Figure 35. FL (red) and FM (gold) top contours before (left) and after (right) incorporating industry feedback.	42
Figure 36. Final dimensions of FF envelopes.	42
Figure 37. Final dimensions of RF envelopes.	43
Figure 38. The bottom of the RF _{CRS} structure must fall below the dashed orange line.	44
Figure 39. Recaro Proride has similar fit problem in FL and vehicle.	46
Figure 40. RF CRS that could not be installed at an acceptable angle in the vehicle.	47
Figure 41. Same RF CRS did not meet bottom contact (left) or angle criteria (right).	47
Figure 42. Locations for assessing gaps with FF CRS.	48
Figure 43. Location of front seat used in ECE assessment of envelope fit.	53

LIST OF TABLES

Table 1.	Number of products by type and manufacturer.....	5
Table 2.	Definition of size code.....	6
Table 3.	Rear-facing child restraint sizes by their rear-facing weight limit and manufacturer.	7
Table 4.	Forward-facing harnessed child restraint sizes by their forward-facing weight limit and manufacturer.	8
Table 5.	List of products, sizes, weight limits, and measurement status.	9
Table 6.	Distribution of products by size categories.....	11
Table 7.	Child restraints purchased for current study	12
Table 8.	Top-selling 2013 vehicles, plus measurement status	13
Table 9.	Selection of new vehicles to measure to create proportional representation of manufactures	14
Table 10.	CRS size groups and sizes included in each	15
Table 11.	Child restraints sorted by test group and size group	16
Table 12.	Installation matrix	17
Table 13.	CRS fit in prototype RM envelope.....	34
Table 14.	Evaluation of RFCRS in envelopes.	45
Table 15.	Evaluation of FF CRS in envelopes.	49
Table 16.	Vehicle assessments with RF _{veh} envelopes	50
Table 17.	Vehicle assessments with FF _{veh} envelopes.....	51

ACKNOWLEDGMENTS

This work was funded by the National Highway Traffic Safety Administration under cooperative agreement DTNH22-10-H-00288 with the University of Michigan.

We would like to acknowledge Nichole Orton, Kevin Weise, Katie Uvick, Frank Perkins, and Juan Madrid for their help in constructing envelopes, developing test procedures, and making drawings.

INTRODUCTION

Motivation

Caregivers often struggle to correctly install child restraint systems (CRS) in their vehicles. Child restraint installation errors occur frequently, as documented in laboratory studies and observational field studies (Decina & Lococo, 2005; Decina & Lococo, 2007; Dukehart, Walker, Lococo, Decina, & Staplin, 2007; Greenwell, 2015; Jermakian et al., 2014; Klinich et al., 2013a and 2013b; Klinich, Manary, Flannagan, Malik, & Reed, 2010; Koppel & Charlton, 2009; Mirman, Curry, Zonfrillo, Corregano, Seifert, & Arbogast, 2014; Tsai & Perel, 2009). In some cases, difficulties arise because some combinations of child restraints and vehicles are incompatible. Examples of incompatibilities include the following.

- Interference between the head restraint and forward-facing (FF) CRS
- Highly contoured vehicle seat cushions that do not permit the CRS to have firm contact with the seat
- Gaps between the back or base of the CRS and vehicle seat cushion or seat back because of incompatible geometries
- Rear-facing (RF) CRS cannot be installed at correct angle because of interference with the vehicle front seat
- RF CRS requiring aftermarket adjustments, such as pool noodles, to achieve correct angle because of incompatibility between CRS and the vehicle seat cushion angle
- Seat belt or LATCH belt cannot be adequately tightened because of geometric incompatibilities between the CRS belt path and the vehicle anchor geometry
- CRS cannot be installed in adjacent vehicle seating positions

These issues are not likely to subside, particularly in light of the trend to keep children seated in child restraints longer. In 2011 the National Highway Traffic Safety Administration recommended that children remain rear-facing as long as possible, and the American Academy of Pediatrics (AAP) recommended that children remain rear-facing at least through their second birthday. They also recommend keeping a child in a forward-facing harnessed restraint as long as possible before switching to a belt-positioning booster seat. In response, child restraint manufacturers have redesigned RF CRS to accommodate larger children; maximum RF weight limits frequently reach 35 or 40 lb. Many FF CRS now have upper weight limits of 65 lb or more. Another factor that could potentially increase the size of CRS is the proposal to modify FMVSS No. 213, Child Restraint Systems, to add side impact testing procedures. At the same time, fuel economy requirements are motivating vehicle manufacturers to reduce vehicle size and mass. As a result, rear seat compartment space can become smaller.

In 2011 NHTSA proposed a voluntary vehicle/child restraint fit evaluation program that would encourage vehicle manufacturers to provide information to consumers about compatibility for vehicle/child restraint pairings (76 FR 10637, 2011). Vehicle manufacturers would publish lists of child restraints that are compatible with a particular vehicle based on several key installation factors. Some of the comments responding to this proposal pointed out the issue that CRS designs evolve more quickly than vehicle designs. A 2015 version of a particular CRS might fit in a 2015 vehicle model, but the 2018

version of the CRS may not. With over 100 CRS models available each year, the large number of possible combinations of vehicles, seating positions, and CRS models would be challenging to assess.

ISO Fit Envelopes

The International Standards Organization (ISO) has developed procedures to try to match the size of CRS with the available interior volume of vehicle seats to help inform consumers' purchasing choices and to aid in vehicle and CRS design decisions. The organization's TC22/SC12/WG1 [Ignition Equipment Working Group] issued ISO 13216-3:2006(E) (ISO, 2006) to define a classification system for child restraints and vehicles that helps consumers choose CRS and vehicles that are dimensionally compatible. The standard defines eight envelopes: three for rear-facing CRSs, three for forward-facing CRSs and two for car beds. Modifications to the standard to add an envelope for booster seats have been recently proposed (ISO, 2015).

A previous University of Michigan Transportation Research Institute (UMTRI) project performed for NHTSA (Hu, Manary, Klinich, & Reed, 2015) used computer simulation to evaluate the FF and RF ISO 13216-3:2006(E) envelopes relative to rear seat compartments from vehicles and CRS in the U.S. market. Three-dimensional geometry models for 26 vehicles and 16 convertible CRS developed previously were used. Geometric models of three forward-facing and three rear-facing CRS envelopes prescribed by the ISO were constructed. A virtual fit process was developed that followed the physical procedures described in the ISO standards. The results showed that most of the RF CRS could fit in at least one of the current ISO RF envelopes, but that half of the FF CRS evaluated could not fit in any of the FF envelopes. From the vehicle perspective, vehicles could usually accommodate most of the FF envelopes. However, most vehicles evaluated could accommodate the smallest RF ISO envelope, but not the largest.

These results suggest that the current ISO envelopes could not be used to assess the range of vehicle and child restraint products available in the United States due to differences in product shapes. While the FF ISO envelopes fit in the vehicles, FF U.S. child restraints often do not fit in the envelopes. The smallest RF ISO envelope fit in most vehicles, but very few RF CRS fit in this envelope.

This previous project concluded that the ISO fit envelopes are not entirely compatible with the range of child restraint products available in the United States. As a result, the current project was proposed to determine how to adapt the ISO envelope method for the U.S. market.

Objectives and Approach

The objective of this project is to develop CRS fit envelopes that would allow improved compatibility between U.S. vehicles and CRS using a procedure modeled after the ISO envelope strategy. The following steps were taken to achieve this goal:

- 1) Existing scans in UMTRI CRS database were reviewed to determine their usability for the project. About 18 to 20 more child restraints were digitized to capture the newest product contours.

- 2) Eight to 10 more 2012-2014 vehicle rear seats were digitized, including the center seat contour, to capture the seat contours (particularly head restraint designs) and key reference points in rear seats of newer vehicles.
- 3) Multiple CRS restraints were installed in the center and outboard positions of the scanned vehicles using LATCH. Locations of key landmarks were documented to provide information on realistic positioning of CRS and envelopes within vehicle seats.
- 4) The research team worked with NHTSA personnel to develop the strategy for generating sets of CRS fit envelopes representing the range of typical U.S. CRS. Possible harmonization with at least some dimensions of the ISO fit envelopes was considered during the process.
- 5) Features on the envelopes were included that allow physical and virtual installation into a vehicle using flexible LATCH.
- 6) Physical versions of the CRS fit envelopes were constructed.
- 7) A procedure for installing the fit envelopes into vehicles was developed that allows both physical and virtual installation in vehicles and considered the installed orientation and position of the child restraints installed in step 3.
- 8) The envelopes and procedures were used to assess fit of CRS within the envelope and the fit of the envelopes within the vehicle.

METHODS

Child Restraint Selection

To begin, child restraint manufacturer websites were checked to make a comprehensive list of child restraint products currently in production as of February 1, 2014. These products met the standards of the most recent FMVSS No. 213 update. Table 1 shows the list of manufacturers, total number of products, and number of products in each child restraint category. The number in parentheses indicates an estimated number of product molds; products that had the same external height, width, depth, and function were assumed to be manufactured from the same mold. For the purposes of judging external size, these were considered “sister” products even if they have different features or masses. Because the term “3-in-1” is used differently by different manufacturers, 3-in-1 products that are used rear-facing, forward-facing, and as a booster are counted under convertibles in this study, while those that are used forward-facing and under multiple booster modes are counted under combination seats. Table 1 also includes a code used to identify each manufacturer for the current study.

Table 1. Number of products by type and manufacturer.

Manufacturer	ID	RF only	Convertible	Combination	Booster
Baby Trend	BT	3 (2)		2	
Britax	BR	3 (2)	8 (3)	3	2 (1)
Bubble Bum	BB				1
Chicco	CH	3(2)	1		1
Clek	CL		1		3 (2)
Combi	CO	1	1		1
Cybox	CY	2			
Diono	DI		3 (1)		2
Dorel (All Brands)	DO	11 (5)	21 (19)	5	15
Dream on Me	DR	1			
Evenflo	EV	3 (2)	8 (5)	5 (2)	7
Graco	GR	4 (2)	4 (3)	2(1)	2
Harmony	HA			1	7 (6)
Kiddy	KI				2
Kids Embrace	KE			1	
Lilly Gold	LG		1		
Orbit Baby	OB	1	1		
Peg Perego	PP	1	1		1
Recaro	RE		2 (1)	1	1
Summer Infant	SI	1			
The First Years	FY	2	3(2)		2
UPPA Baby	UP	1			
Total		37(25)	55(40)	20(16)	47(43)

Each product was given both a product code and a size code. For the product code, the first digit corresponds to the type of product: R (rear-facing only), C (convertible), F (combination), and B (booster). The next digits correspond to the manufacturer code listed in Table 1, and the last digit numbers the products within that category for the manufacturer. Thus for BabyTrend, the three rear-facing only products would be coded as RBT1, RBT2, and RBT2, because two of the products appear to be sister products made from the same mold.

To indicate the product size, each product was given a three-letter code corresponding to the Height, Width, and Depth of the product as defined in Table 2. Among all the products, the range of values on each of the three dimensions was divided into five categories (petite, small, medium, large, grande) based on the distribution of values on that dimension. Thus a product with height of 26 in, width of 20.5 in, and depth of 21 in would be coded as size LMM, while one with a height of 17.5 in, 25 in, 26.5 in would be coded as size SGL. For reference, the widths of all ISO envelopes are 17.3 in (440 mm), placing them in the S width category. The heights range from 600 to 720 mm (23.6 in to 28.3 in), while the depths range from 535 to 780 mm (21.1 in to 30.7 in), which place them in the M and L height and depth categories.

Table 2. Definition of size code

	Height (in)	Width (in)	Depth (in)
Smallest (petite) (P)	<15	< 16	<15
Small (S)	15.0-19.9	16.0-18.5	15.0-19.9
Medium (M)	20.0-24.9	18.6-20.9	20.0-24.9
Large (L)	25.0-29.9	21.0-24.9	25.0-29.9
Largest (grande) (G)	30+	25+	30+

Products were then sorted by their rear-facing and forward-facing weight limits. Table 3 lists the size codes for all rear-facing products by the upper occupant weight limit and manufacturer, while Table 4 provides the same information for the forward-facing harnessed products. In both tables, convertibles are indicated by standard font, while italics indicate either a rear-facing only or forward-facing only restraint. The number in parentheses next to a size code indicates the number of models falling within that size. Bold text indicates child restraints for which scans of a product with the same name were already in the UMTRI database. In Table 3, products with maximum rear-facing limits of 22 lb were considered category R1, while those with maximum limits of 30 lb were called R2. Products with RF weight limits from 32-40 lb are grouped together (blue columns=R3), as are those with RF weight limits over 40 lb (gray columns=R4.) In Table 4, products were grouped into three FF maximum weight limit categories: 40-50 lb (F1), 55-65 lb (F2), and > 65 lb (F3).

When choosing child restraints for measurement in this study, the goal was to collect at least six products within each weight limit grouping of multiple sizes from a variety of manufacturers. Underlining indicates products that were selected for measurement in this study. Bold text indicates products that have been measured for the study that are still being sold. Eleven products are rear-facing only (*italics*), six are convertibles, two are combination, and one is a booster. Priority was given to products with sister products, particularly those in more than one weight limit category. After scanning the listed products, the database includes scans representing 9 of 12 RF (22), 9 of 11 RF (30), 25 of 65 RF (32-40), 2 of 4 RF (> 40), 10 of 21 FF (40-50), 17 of 38 FF (55-65), and 9 of 22 FF (> 70 w/LATCH).

Table 3. Rear-facing child restraint sizes by their rear-facing weight limit and manufacturer.

Manufacturer	R1	R2	R3			R4	
	RF22	RF30	RF32/ 33	RF35	RF40	RF45	RF50
Baby Trend	<i>LSL*</i>	<i>LSL*</i>	<i>LSL</i>				
Britax		<i>SSG</i> , <i>SSL</i> <i>(2)</i>		LMM (2)	LMM, LSM (5)		
Chicco	<i>MSM</i>	<i>LSS</i> <i>(2)</i>			LMM		
Clek							LSG
Combi			LPS	<i>LSL</i>			
Cybox			<i>MSL</i>	<i>SSL</i>			
Diono					LSS*	LSS (2)*	
Dorel (All Brands)	<i>GSS</i> , <i>LSG</i> <i>MSG</i> <i>(4)</i>	<i>MSS</i>		LMS , LSS* , LSS, <i>MSL (3)</i> , <i>MSL (2)</i> , GSS	LMM , LMP, LSM, <i>GMS (2)</i> , <i>GPS</i> , LMM, LMM, LMM, LMM, LSM, LSS* , <i>MSP (2)</i>		
Dream on Me	<i>LSM</i>						
Evenflo	<i>LSP</i>				LML (2) , LML, LSL, <i>LSL(3)</i> , LSM		
Graco	<i>MSL*</i>	LMS* , <i>MSL*</i>		<i>SMG (2)</i>	LMM, <i>LML</i> , LMS* , <i>LMP (2)</i>		
Lilly Gold		<i>SSM</i>					
Orbit Baby	<i>LMS</i>			LMS			
Peg Perego		<i>LSL</i>				LMS	
Recaro							
Summer Infant				<i>LMS</i>			
The First Years				<i>GSS</i> , <i>MMM (2)</i> , <i>SGL</i> , SGM			
UPPA Baby				<i>LSL</i>			
Total	12	11	3	23			
Already measured	0	1	0	3	5 (+1)		
Proposed	5 (+1)	6	0	2	4 (+1)		
Total measured	6	7			16		

Key: *Italics=rear-facing only*; others are convertibles. Underline=proposed, **Bold=already measured**,

*same shell used for products with different maximum weight limits

Table 4. Forward-facing harnessed child restraint sizes by their forward-facing weight limit and manufacturer.

Manufacturer	F1		F2		F3	
	FF40	FF50	FF55	FF65	FF70	FF80+
Baby Trend		GLP				<u>GSS</u>
Britax		LMM	LSM*	LSM (4)* , LMM, LMM		<i>GMM</i> , GMM , <i>GMM</i> , <i>GSS</i> (2)
Chicco				LMM		<i>LSS</i>
Clek				LSG		<i>SSP</i>
Combi	LPS					<i>LMS</i>
Diono			F	LSS		LSS (2)
Dorel (All Brands)	LSS (2) , MMP, LMS	LMS , LMS , LSS, GSS		LMM, LMP, <u>GPS</u> , LMM, LMM, LMM, LSM, MMP, MSP(2), <i>GPS</i> , <i>LSS</i>	<u>GMS (2)</u> , LMM, MMM, MSL, LSM	<i>LPS</i> , <i>LSS</i> , <i>GSS</i> , <i>LSP</i> , <i>LSS</i> , <i>LSS</i> , <u>SML</u>
Evenflo	<u>LSL (3)</u> , <i>LSS</i>	LMM*		LML (2) , LML, LSL, LSM, LMM (2)*		<i>GMS</i> , <i>GPP</i> , <i>LSS</i> , <i>LMS</i> , <i>LSS</i>
Graco	LMS*	LMS*		LMM, <u>LML</u> , <u>LMM*</u> ,		<i>LSS</i> , <u>LMM</u>
Harmony				GSS		<i>GSM</i> , <i>GSSS</i> , <i>GSS</i> , <i>GSS</i>
Kids Embrace				<i>LSS</i>		
Lilly Gold	SSM					
Orbit Baby				LMS		
Peg Perego					LMS	<i>LSS</i>
Recaro					<u>LMP (2)</u>	<i>GSP</i> , <i>GMS</i>
The First Years				<u>MMM (2)</u> , <i>SGM</i>		<i>SGM</i> , <i>SSL</i>
Total		20		38		46
Already measured	2	3 (+1)	(+1)	6		2
Proposed	1	0	0	4	2	2
Total		7		10		6

Key: *Italics=forward-facing only*; others are convertibles. **Underline=already measured**, **Bold=proposed**, *same shell used for products in different weight categories

Overall, the scanned child restraints represent 54 of the 161 different child restraint products available for sale in February 2014 as listed in Table 5, together with specific dimensions of each product. In addition, these products span the general range of sizes that apply to all products, including boosters. Table 6 shows the distribution of products by size code. The list of the measured (M), proposed (P), and sister (S) products are listed in Table 5, as well as the size code and weight limits. When choosing from among sister products, the least expensive option was selected as indicated in Table 7.

Table 5. List of products, sizes, weight limits, and measurement status.

Manufacturer	Product	Type	CODE	Ht	W	Dep	SIZE	Limit 1	Limit 2	Status	RFCat	FFCat
Baby Trend	TrendZ FastBack 3-in-1	combo	FBT1	31.0	17.5	17.8	GSS	FF70	HB100	P	N	F3
Baby Trend	Flex-Loc	rf only	RBT1	25.0	16.5	26.0	LSL	RF30	-	P	R2	N
Baby Trend	EZ Flex-Loc	rf only	RBT1	25.0	16.5	26.0	LSL	RF22	-	S	R1	N
Britax	Roundabout	conv	CBR3	26.0	18.5	21.0	LSM	RF40	FF55	M	R3	F2
Britax	Boulevard	conv	CBR3	26.0	18.5	21.0	LSM	RF40	FF65	S	R3	F2
Britax	Highway	conv	CBR3	26.0	18.5	21.0	LSM	RF40	FF65	S	R3	F2
Britax	Marathon	conv	CBR3	26.0	18.5	21.0	LSM	RF40	FF65	S	R3	F2
Britax	Pavilion	conv	CBR3	26.0	18.5	21.0	LSM	RF40	FF65	S	R3	F2
Britax	Frontier 90	combo	FBR1	36.0	19.0	21.0	GMM	FF90	HB120	M?	N	F3
Britax	B-SAFE	rf only	RBR2	15.5	17.5	27.5	SSL	RF30	-	P	R2	N
Britax	BOB B-SAFE	rf only	RBR2	15.5	17.5	27.5	SSL	RF30	-	S	R2	N
Chicco	KeyFit 30	rf only	RCH1	28.5	17.3	15.0	LSS	RF30	-	P	R2	N
Chicco	KeyFit 30 Magic	rf only	RCH1	28.6	17.4	15.1	LSS	RF30	-	S	R2	N
Chicco	KeyFit	rf only	RCH2	22.0	17.0	24.0	MSM	RF22	-	P	R1	N
Diono	Radian R100	conv	CDI1	28.5	17.0	16.0	LSS	RF40	FF65	M	R3	F2
Diono	Radian R120	conv	CDI1	28.5	17.0	16.0	LSS	RF45	FF80	S	R4	F3
Diono	Radian RXT	conv	CDI1	28.5	17.0	16.0	LSS	RF45	FF80	S	R4	F3
Dorel	RodiFix	booster	BDO13	18.5	19.5	29.5	SML	HB120	-	P	N	F3
Dorel	onSide air	conv	CD013	26.5	17.5	17.0	LSS	RF40	FF40	S	R3	F1
Dorel	Scenera	conv	CDO13	26.5	17.5	17.0	LSS	RF35	FF40	M	R3	F1
Dorel	Alpha Omega Elite	conv	CDO2	25.3	20.0	19.5	LMS	RF35	FF50	M	R3	F1
Dorel	Pria 70	conv	CDO5	29.8	20.5	18.5	GMS	RF40	FF70	P	R3	F3
Dorel	Guide 65 Sport	conv	CDO6	30.5	14.0	18.5	GPS	RF40	FF65	P	R3	F2
Dorel	3-in-1	conv	CDO7	26.5	21.0	20.5	LMM	RF40	FF65	M	R3	F2
Dorel	Summit	combo	FDO4	28.0	20.0	19.5	LMS	FF40	HB100	M	N	F1
Dorel	Mico	rf only	RDO2	28.5	17.5	30.9	LSG	RF22	-	P	R1	N
Dorel	Comfy Carry	rf only	RDO3	23.5	17.0	30.0	MSG	RF22	-	P	R1	N
Dorel	Comfy Carry Elite	rf only	RDO3	23.5	17.0	30.0	MSG	RF22	-	S	R1	N

Manufacturer	Product	Type	CODE	Ht	W	Dep	SIZE	Limit 1	Limit 2	Status	RFCat	FFCat
<u>Dorel</u>	<u>Comfy Carry Elite Plus</u>	<u>rf only</u>	<u>RDO3</u>	<u>23.5</u>	<u>17.0</u>	<u>30.0</u>	<u>MSG</u>	<u>RF22</u>	-	<u>S</u>	<u>R1</u>	<u>N</u>
<u>Dorel</u>	<u>Disney Comfy Carry Elite Plus</u>	<u>rf only</u>	<u>RDO3</u>	<u>23.5</u>	<u>17.0</u>	<u>30.0</u>	<u>MSG</u>	<u>RF22</u>	-	<u>S</u>	<u>R1</u>	<u>N</u>
<u>Dorel</u>	<u>Prezi</u>	<u>rf only</u>	<u>RDO5</u>	<u>21.5</u>	<u>16.8</u>	<u>15.0</u>	<u>MSS</u>	<u>RF30</u>		<u>P</u>	<u>R2</u>	<u>N</u>
Evenflo	Symphony LX All-In-One	conv	CEV1	25.5	21.0	28.0	LML	RF40	FF65	M	R3	F2
Evenflo	Symphony DLX All-In-One	conv	CEV1	25.5	21.0	28.0	LML	RF40	FF65	S	R3	F2
<u>Evenflo</u>	<u>Tribute LX</u>	<u>conv</u>	<u>CEV4</u>	<u>25.5</u>	<u>18.5</u>	<u>27.6</u>	<u>LSL</u>	<u>RF40</u>	<u>FF40</u>	<u>P</u>	<u>R3</u>	<u>F1</u>
<u>Evenflo</u>	<u>Tribute Select</u>	<u>conv</u>	<u>CEV4</u>	<u>25.5</u>	<u>18.5</u>	<u>27.6</u>	<u>LSL</u>	<u>RF40</u>	<u>FF40</u>	<u>S</u>	<u>R3</u>	<u>F1</u>
<u>Evenflo</u>	<u>Tribute Sport</u>	<u>conv</u>	<u>CEV4</u>	<u>25.5</u>	<u>18.5</u>	<u>27.6</u>	<u>LSL</u>	<u>RF40</u>	<u>FF40</u>	<u>S</u>	<u>R3</u>	<u>F1</u>
Evenflo	Maestro	combo	FEV1	27.0	19.0	20.5	LMM	FF50	HB110	M	N	F1
Evenflo	SecureKid DLX	combo	FEV1	26.0	19.0	21.0	LMM	FF65	HB110	S	N	F2
Evenflo	SecureKid LX	combo	FEV1	26.0	19.0	21.0	LMM	FF65	HB110	S	N	F2
<u>Evenflo</u>	<u>Nurture</u>	<u>rf only</u>	<u>REV1</u>	<u>28.0</u>	<u>18.0</u>	<u>11.0</u>	<u>LSP</u>	<u>RF22</u>		<u>P</u>	<u>R1</u>	<u>N</u>
<u>Graco</u>	<u>My Ride 65</u>	<u>conv</u>	<u>CGR1</u>	<u>26.0</u>	<u>20.8</u>	<u>27.0</u>	<u>LML</u>	<u>RF40</u>	<u>FF65</u>	<u>P</u>	<u>R3</u>	<u>F2</u>
Graco	ComfortSport	conv	CGR2	26.5	20.0	18.5	LMS	RF30	FF40	M	R2	F1
Graco	ClassicRide 50	conv	CGR2	26.5	20.0	18.5	LMS	RF40	FF50	S	R3	F1
<u>Graco</u>	<u>Argos 70</u>	<u>combo</u>	<u>FGR1</u>	<u>29.0</u>	<u>20.0</u>	<u>22.0</u>	<u>LMM</u>	<u>FF70</u>	<u>HB100</u>	<u>P</u>	<u>N</u>	<u>F3</u>
<u>Graco</u>	<u>Nautilus 3-in-1</u>	<u>combo</u>	<u>FGR2</u>	<u>29.0</u>	<u>20.0</u>	<u>22.0</u>	<u>LMM</u>	<u>FF65</u>	<u>HB100</u>	<u>S</u>	<u>N</u>	<u>F2</u>
<u>Graco</u>	<u>SnugRide Classic Connect Infant</u>	<u>rf only</u>	<u>RGR1</u>	<u>24.2</u>	<u>17.5</u>	<u>26.7</u>	<u>MSL</u>	<u>RF22</u>	-	<u>P</u>	<u>R1</u>	<u>N</u>
<u>Graco</u>	<u>SnugRide Classic Connect 30</u>	<u>rf only</u>	<u>RGR1</u>	<u>24.0</u>	<u>16.5</u>	<u>27.0</u>	<u>MSL</u>	<u>RF30</u>	-	<u>S</u>	<u>R2</u>	<u>N</u>
<u>Graco</u>	<u>SnugRideClassic Connect 35</u>	<u>rf only</u>	<u>RGR2</u>	<u>15.6</u>	<u>18.7</u>	<u>30.7</u>	<u>SMG</u>	<u>RF35</u>	-	<u>P</u>	<u>R3</u>	<u>N</u>
Orbit Baby	Toddler Car Seat G3	conv	COB1	29.0	22.4	18.9	LMS	RF35	FF65	M?	R3	F2
<u>Peg Perego</u>	<u>Primo Viaggio SIP</u>	<u>rf only</u>	<u>RPP1</u>	<u>25.8</u>	<u>17.3</u>	<u>25.8</u>	<u>LSL</u>	<u>RF30</u>		<u>P</u>	<u>R2</u>	<u>N</u>
<u>Recaro</u>	<u>ProRIDE</u>	<u>conv</u>	<u>CRE1</u>	<u>29.0</u>	<u>19.0</u>	<u>11.0</u>	<u>LMP</u>	<u>RF40</u>	<u>FF70</u>	<u>P</u>	<u>R3</u>	<u>F3</u>
<u>Recaro</u>	<u>Performance RIDE</u>	<u>conv</u>	<u>CRE1</u>	<u>29.0</u>	<u>19.0</u>	<u>11.0</u>	<u>LMP</u>	<u>RF40</u>	<u>FF70</u>	<u>S</u>	<u>R3</u>	<u>F3</u>
<u>The First Years</u>	<u>True Fit SI</u>	<u>conv</u>	<u>CFY1</u>	<u>23.5</u>	<u>23.0</u>	<u>20.0</u>	<u>MMM</u>	<u>RF35</u>	<u>FF65</u>	<u>P</u>	<u>R3</u>	<u>F2</u>
<u>The First Years</u>	<u>True Fit Ialert</u>	<u>conv</u>	<u>CFY1</u>	<u>22.8</u>	<u>22.5</u>	<u>20.0</u>	<u>MMM</u>	<u>RF35</u>	<u>FF65</u>	<u>S</u>	<u>R3</u>	<u>F2</u>

M=already measured. S=sister product measured. P=proposed. S=sister product proposed. RFCat and FFCat correspond to max weight limits defined above.

Table 6. Distribution of products by size categories.

Width	Depth	Height				
		P	S	M	L	G
P	P	BBB1, BDO8	BCL1, BDO14, BDO15			BEV7
	S	BDO9, BEV3			BDO2, CCO1	CDO6, FDO1
	MSL					
S	P	BHA5	BCL2 (2)	CDO19 (2)	BDO3, REV1	FRE1
	S	BDO10 (2), BDO11, BDO12, BEV4, BGR1, BHA6, BHA7 (2)		RDO5 (2)	BCH1, BDO4, BDO5, BDO6, BEV5, BEV6, BGR2, BKI2, BPP1, <u>CDO13 (2), CDI1 (3),</u> CDO4, FDO5, FEV2 (2), FK31, RCH1 (2)	BBR1 (2), BDO1, BHA2, BHA3, BHA4, FBT1 , DO2, FHA1, RDO1 (2), RFY1
	M		CLG1	RCH2	<u>CBR3 (5),</u> CDO12, CDO3, CEV5, RDR1	BHA1
	L		BFY2, RBR2 (2), RCY2	CDO18, RCY1, RDO4 (3), REV2 (2), RGR1(2)	CEV3, CEV4 (3), RBT1 (2), RBT2, RCO1, RPP1, RUP1	
	G		RBR1	RDO3 (4)	CCL1, RDO2	
M	P			CDO15, CDO16	CRE1 (2)	
	S	BDO7, BDI2			BCO1, BDI1, BEV2, <u>CDO2, CGR2(2), COB1,</u> CPP1, FDO3, <u>FDO4,</u> ROB1, RSI1	BEV1, BRE1, CDO5 (2),
	M			CDO14, CFY1 (2)	CBR1, CBR2 (2), CCH1, CDO10, CDO11, <u>CDO7,</u> CDO8, CDO9, CGR3, <u>FEV1 (3), FGR1 (2)</u>	FBR1, FBR2, FBR3
	L				<u>CEV1 (2),</u> CEV2, CGR1	
	G					
L	P					FBT2
	SM					
	L		BDO13			
	G		RGR2 (2)			
G	PS					
	M		BFY1, CFY2			
	L		RFY2			
	G					

Table 7. Child restraints purchased for current study

Manufacturer	Product	Type
Dorel Maxi Cosi	RodiFix	booster
Baby Trend	TrendZ FastBack 3-in-1	combo
Graco	Argos 70	combo
Dorel Maxi Cosi	Pria 70	convertible
Dorel Safety 1st	Guide 65 Sport	convertible
Evenflo	Tribute LX	convertible
Graco	My Ride 65	convertible
Recaro	ProRIDE	convertible
The First Years	True Fit SI	convertible
Baby Trend	Flex-Loc	rf only
Britax	B-SAFE	rf only
Chicco	KeyFit 30	rf only
Chicco	KeyFit	rf only
Dorel Cosco	Comfy Carry	rf only
Dorel Maxi Cosi	Mico	rf only
Dorel Maxi Cosi	Prezi	rf only
Evenflo	Nurture	rf only
Graco	SnugRide Classic Connect Infant	rf only
Graco	SnugRideClassic Connect 35	rf only
Peg Perego	Primo Viaggio SIP	rf only

Vehicle Selection Process

Ten new vehicles were scanned and used for child restraint installations. To select new vehicles for testing, a list of the top 50 best-selling vehicles from 2013 was extracted from *Automotive News*. Table 8 lists for each of these best-selling vehicles if it (or a sister vehicle) had been previously measured, and if so, what model year was measured.

Table 8. Top-selling 2013 vehicles, plus measurement status

2013 Sales Rank	Make/Model	Measured?	Year
1	Ford F150	Y	2011
2	Chevrolet Silverado LTZ	Y	2000
3	Toyota Camry	Y	2002
4	Honda Accord	Y	2004
4	Honda Accord	Y	2007
5	Ram 1500	Y	2005
6	Honda Civic	Y	2010
7	Nissan Altima	Y	2003
8	Honda CR-V	Y	2003
9	Toyota Corolla	Y	2003
10	Ford Escape	M	
11	Ford Fusion	N	
12	Chevrolet Cruze	M	
13	Hyundai Elantra	N	
14	Chevrolet Equinox LTZ	M	
15	Ford Focus	Y	2004
16	Toyota RAV4	M	
17	Hyundai Sonata	Y	2011
18	Chevrolet Malibu	Y	2003
19	Ford Explorer	Y	2011
20	GMC-Sierra	S	
21	Jeep Grand Cherokee	Y	2004
22	Volkswagen Jetta	M	
23	Nissan Rogue	M	
24	Toyota Tacoma	Y	2002
25	Toyota Prius	Y	2006
26	Chevrolet Impala	Y	2011
27	Kia Optima	M	
28	Jeep Wrangler	N	
29	Nissan Sentra	N	
30	Ford Edge	N	
31	Honda Odyssey	M	
32	Toyota Highlander	N	
33	Honda Pilot	N	
34	Dodge Grand Caravan	Y	2011
35	Subaru Forester	Y	1998
36	Chrysler 200	M	
37	Chrysler Town & Country	S	

2013 Sales Rank	Make/Model	Measured?	Year
38	Toyota Sienna	Y	2011
39	BMW 3-series & 4-series	N	
40	Kia Soul	Y	2011
41	Subaru Outback	M	
42	Nissan Versa	Y	2011
43	Toyota Tundra	N	
44	Volkswagen Passat	Y	2002
45	Kia Sorento	N	
46	Mazda 3	Y	2011
47	Lexus RX	N	
48	GMC Terrain	N	
49	Dodge Charger	N	
50	Chevrolet Traverse	Y	2011

Y=previously digitized, S=sister vehicle measured, M=measured in current study, N=Not measured

Table 9 indicates the ten new vehicles selected for measurement (indicated by M in Table 8) that achieved a distribution of vehicles by manufacturer that approximated the distribution of vehicles by manufacturer of the top selling 2013 vehicles. An additional goal was to choose a variety of vehicle types for testing (such as sedan versus SUV).

Table 9. Selection of new vehicles to measure to create proportional representation of manufactures

Make	# in Top 50	Measured MY 2010+	Measured < MY 2010	Proposed MY 2013-2014	Total
GM	8	2	2	2	6
Chrysler	7	2	2	1	5
Ford	6	2	1	1	4
Honda	6	1	3	1	5
Hyundai	2	1	0		1
Kia	3	1		1	2
Lexus	1				0
Mazda	1	1			1
Nissan	4	1	1	1	3
Subaru	2		1	1	2
Toyota	8	1	4	1	6
Volkswagen	2	0	1	1	2
BMW	1	0	0	0	0

Test Matrix

Between the 20 newly purchased child restraints and the inventory products still in production, 31 child restraint products were available for measurement in vehicles. For each vehicle tested, the vehicle geometry was recorded first, followed by installing child restraints and measuring their orientation. Because time constraints would not permit installation of all child restraints in all configurations in all vehicles, they were divided into four groups. Group 1 was installed in all vehicles, while Groups 2 through 4 were each installed in three or four vehicles.

Child restraints were first categorized into size groups. All the products that were forward-facing only (either boosters or combination seats) were placed in Group 1. The remaining products were grouped by similar sizes as indicated in Table 10. For example, Group 2 includes products with heights in the large range, widths in the medium range, and depths in the medium and large range. Group 3 includes heights in the large or grande range, widths in the medium regions, and depths in the petite or small range.

Table 10. CRS size groups and sizes included in each

Size Group	Products/Sizes Included
1	FF Only
2	LML, LMM
3	LMP, LMS, GMS
4	LSM, LSL, LSG
5	LSS, LSP, LSS, LSS, GPS
6	MSS, MMM, MSM, MMM
7	SMG, MSG, MSL, SSL

Child restraints were then categorized into test groups. Products in Test Group 1 were selected such that they included the most common manufacturers among the child restraints being tested. Other criteria were to have one product from each size group, as well as a variety of product styles (rear-facing only, convertible, and combination). The process was then repeated for size groups 2 through 4, also trying to achieve a variety of product sizes, manufacturers, and weight limits (Rlim=RF weight limit; Flim=FF weight limit). The products in each test group are listed in Table 11. Each child restraint in the UMTRI database as a unique code. (B indicates product was scanned in an earlier booster study, C indicates product was scanned in an earlier study of convertibles, and E indicates product was scanned for the current study.)

Table 11. Child restraints sorted by test group and size group

Code	Model Name	Brand	Size	Size Group	Rlim	Flim	Blim	Test group
B08	Summit	Dorel Eddie Bauer	LMS	1		40	100	1
C11	Symphony	Evenflo	LML	2	40	65	110	1
E08	ProRIDE	Recaro	LMP	3	40	70		1
C07	Boulevard CS	Britax	LSM	4	40	65		1
E12	KeyFit 30	Chicco	LSS	5	30			1
E16	Prezi	Dorel MaxiCosi	MSS	6	30			1
E19	SnugRide Classic Connect 35	Graco	SMG	7	35			1
B38	Maestro	Evenflo	LMM	1		50	110	2
C14	Deluxe 3-in-1	Dorel Eddie Bauer	LMM	2	35	50	100	2
C12	Comfort Sport	Graco	LMS	3	30	40		2
E10	Flex-Loc	Baby Trend	LSL	4	30			2
E17	Nurture	Evenflo	LSP	5	22			2
C03	Radian 80SL	Sunshine Kids	LSS	5	40	65	100	2
E09	True Fit SI	The First Years	MMM	6	35	65		2
E14	Comfy Carry	Dorel Cosco	MSG	7	22			2
B35	Frontier 85	Britax	GMM	1		90	120	3
E01	Rodi Fix	Dorel MaxiCosi	SML	1			120	3
E07	My Ride 65	Graco	LML	2	40	65		3
E04	Pria 70	Dorel MaxiCosi	GMS	3	40	70		3
E20	Primo Viaggio SIP	Peg Perego	LSL	4	30			3
C16	Scenera	Dorel Safety 1st	LSS	5	35	40		3
E13	KeyFit	Chicco	MSM	6	22			3
E18	SnugRide Classic Connect TrendZ	Graco	MSL	7	35			3
E02	FastBack 3-in-1	Baby Trend	GSS	1		70	120	4
E03	Argos 70	Graco	LMM	1		70	120	4
C13	Alpha Omega Elite	Dorel Safety 1st	LMS	3	40	65	100	4
C01	Toddler Car Seat	Orbit Baby	LMS	3	35	65		4
E15	Mico	Dorel MaxiCosi	LSG	4	22			4
E05	Guide 65 Sport	Dorel Safety 1st	GPS	5	40	65		4
E06	Tribute LX	Evenflo	MMM	6	40	40		4
E11	B-SAFE	Britax	SSL	7	30			4

Each time a child restraint was tested, it was installed and measured in all modes, similar to how a parent might use the same product rear-facing, forward-facing, and as a booster. When the product had more than one allowable recline angle or head restraint position, conditions that produced the largest and smallest profile were evaluated. This was usually the maximum head rest position with the reclined position and the minimum head restraint position with the upright position. This choice assumes that other combinations would fall within the space defined by these two configurations.

Table 12 shows the installation matrix used. All vehicles were tested with test group 1 child restraints in the 2L position (second row left behind driver). Three products from test group 1 were also installed in the center position of each vehicle (2C). (CRS 1.1 would be from test group 1 and size group 1.) Vehicles were then sorted by type, and assigned test groups 2, 3, and 4 such that they would be installed at least once in a sedan, in a smaller SUV, and in the other vehicles. Four child restraints from each of these test groups were also selected for installation in the center position.

Table 12. Installation matrix by test group

Type	Vehicle	Code	2L	2C	2C	2C	2L	2C	2C	2C	2C
SUV	Ford Escape	V01	Group 1	1.1	1.4	1.7	Group 2	2.1	2.5a	2.6	2.4
SUV	Nissan Rogue	V02	Group 1	1.2	1.5	1.1	Group 3	3.2	3.4	3.1b	3.5
SUV	Toyota RAV4	V03	Group 1	1.3	1.6	1.2	Group 4	4.3a	4.5	4.1b	4.7
minivan	Honda Odyssey	V04	Group 1	1.4	1.7	1.3	Group 2	2.4	2.6	2.2	2.5a
SUV	Chevrolet Equinox LTZ	V05	Group 1	1.5	1.1	1.4	Group 3	3.5	3.7	3.6	3.2
wagon	Subaru Outback	V06	Group 1	1.6	1.2	1.5	Group 4	4.6	4.1a	4.7	4.3b
sedan	Chevrolet Cruze	V07	Group 1	1.7	1.3	1.6	Group 2	2.7	2.3	2.5b	2.1
sedan	Kia Optima	V08	Group 1	1.1	1.4	1.7	Group 3	3.1a	3.3	3.6	3.4
sedan	Volkswagen Jetta	V09	Group 1	1.2	1.5	1.1	Group 4	4.3b	4.4	4.1a	4.6
sedan	Chrysler 200	V10	Group 1	1.3	1.6	1.2	Group 2	2.2	2.5b	2.3	2.7

Scan and Orientation Measurements

The geometry of each CRS was documented using the stream option available with the FARO Arm 3-D coordinate measurement system. An example of a CRS and its scanned geometry is shown in Figure 1.



Figure 1. Example of a rear-facing CRS and its scanned geometry.

Each CRS was scanned in the lab in all possible configurations. For example, the headrest was placed in the highest and lowest positions, and the recline adjustment was set to the lowest and highest allowable angles. Three reference points on each CRS component were marked with targets, typically near the top, front, and middle of the side profile. Each CRS was also scanned in all applicable modes: rear-facing, forward-facing, and booster.

For vehicle scans, front and rear adjustable seats were set to full-down, full-rear position, a seat back angle of 23°, and with any lumbar adjustment at its lowest setting. In addition to the vehicle geometry shown below, the SAE J826 manikin was used to locate the H-point location of the front and rear seats, as well as to measure cushion length and hip angle. Data were measured regarding seat track adjustability to allow simulation of mid-track and other positions during analysis.

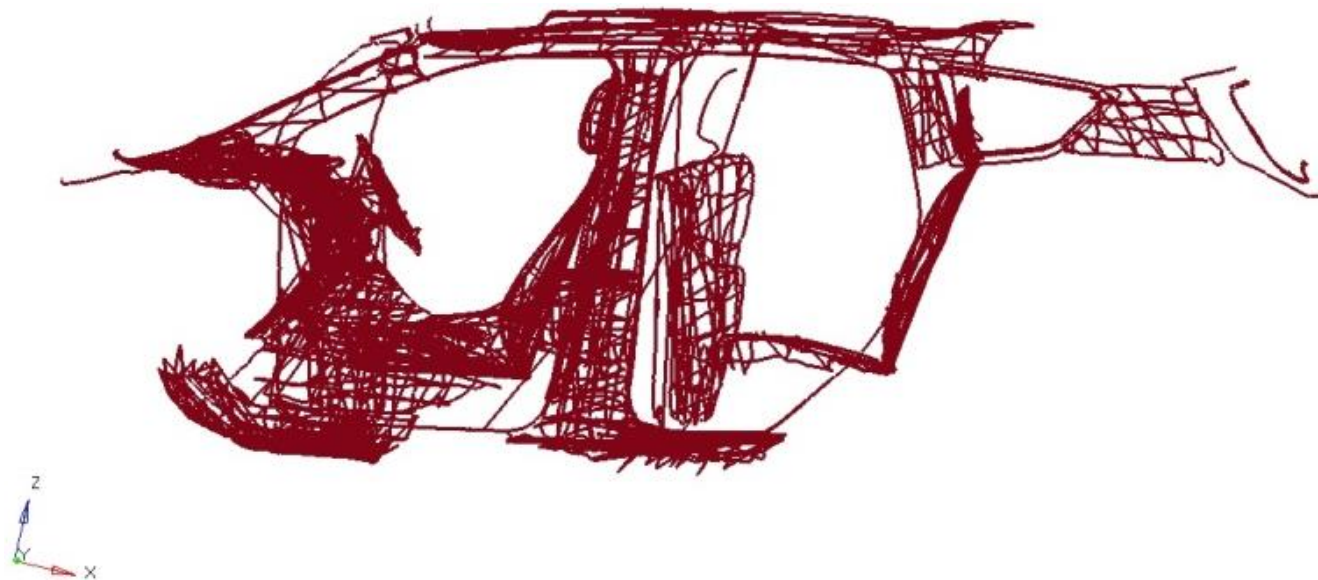

Figure 2. Example of geometry from a vehicle scan.

All installations were performed using LATCH according to the vehicle and CRS instruction manuals. (An exception is that center position installations were performed using improvised LATCH, even if manufacturers did not indicate that the inboard lower anchors (LA) from the outboard seating positions could be used to install a CRS in the center seating position.) The tether was used in all forward-facing harnessed installations, but not in any rear-facing installations even if allowed by the CRS manufacturer. Using the tightness level recommended by the Child Passenger Safety Technician Curriculum, the LATCH belt was tightened so the CRS could move less than 2.5 cm when pushed at the belt path from side to side or fore and aft. Rear-facing CRS were installed at an angle closest to the midpoint of the allowable range, without using any supplementary elements such as pool noodles. For CRS with a carrying handle, the default handle position was fully down, unless another position was required by the manufacturer. If the handle interfered with the front seat and another handle position was allowed for use, it was shifted to the alternate position.

If a rear seat back was adjustable, it was either set to the location specified by the vehicle manufacturer, or set to an angle of 23° if no angle was specified for child restraint installation. The front seat was set to the full-down mid-track position with the seat back at 23°.

For each installation, the FARO arm was used to digitize the coordinates of all the reference landmarks on each CRS. In addition, the points on the LATCH belt that contact the CRS belt path were digitized, as well as the contact points on the lower anchor bar where the LATCH belt connector was attached.

Envelope Design Process

The vehicle and CRS scans were imported into Hypermesh for processing. The H-point of the 2L seating position was used as the origin for each vehicle. The reference points measured on each installed CRS were used to position the CRS scan relative to each vehicle seat contour. Examples are shown in Figure 3.

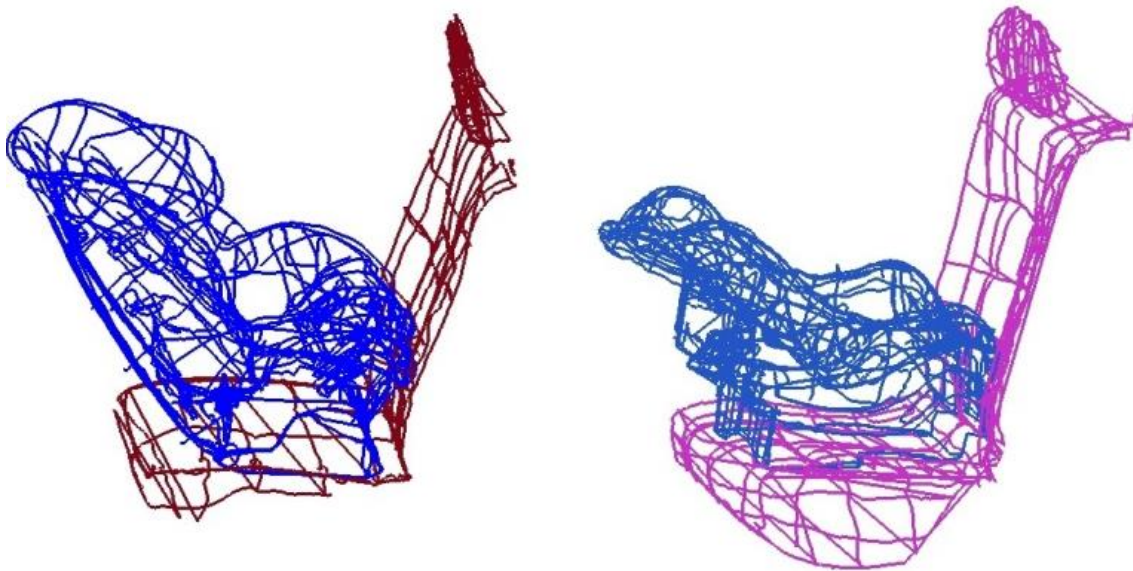

Figure 3. Example of CRS geometry positioned relative to seating position using reference coordinates.

The design of fit envelopes began using rear-facing installations. Of the ten vehicles, installations in four vehicles, which allowed inclusion of all rear-facing products, were considered for designing the fit envelopes. The two vehicles with the highest and lowest cushion and seat back angles, plus two vehicles with intermediate angles, were chosen to evaluate the installed RF CRS conditions. For these installations, only installations with the correct angle were used, and no particular RF CRS was an “outlier” in terms of its installed position.

The first step was to compare the installed CRS profiles and orientations to the ISO R1, R2, and R3 envelopes while positioning the envelope in an “installed” configuration. Figure 4 shows a comparison of installed CRS profiles with the R3 ISO envelope. For the 25 RF CRS measured, none fit in R1, one fit in R2, and seven would fit in R3 if the envelope was about 1 cm wider.

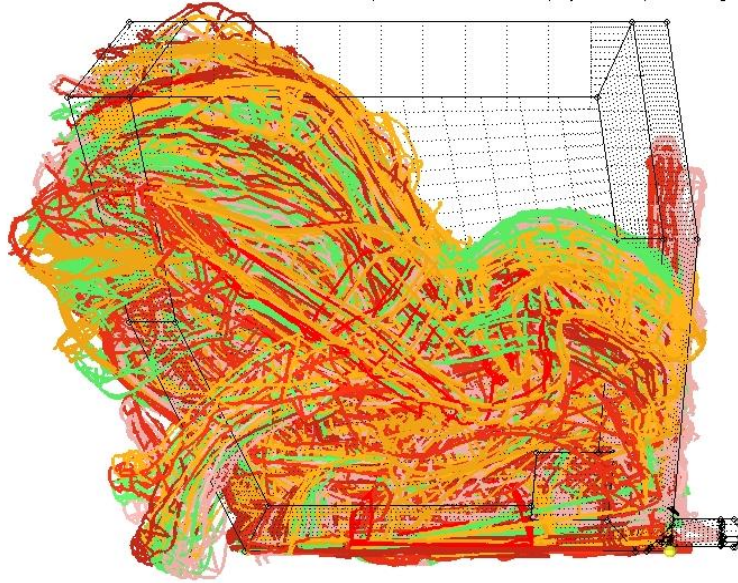

Figure 4. Installed RF CRS positions in four vehicles compared to the ISO R3 envelope.

The next step was to “stretch” the R3 box until it encompassed all the installed RF child restraints, excluding any carry handles. An example of this envelope is shown in Figure 5. The placement of the envelope in a sample vehicle is shown in Figure 6.

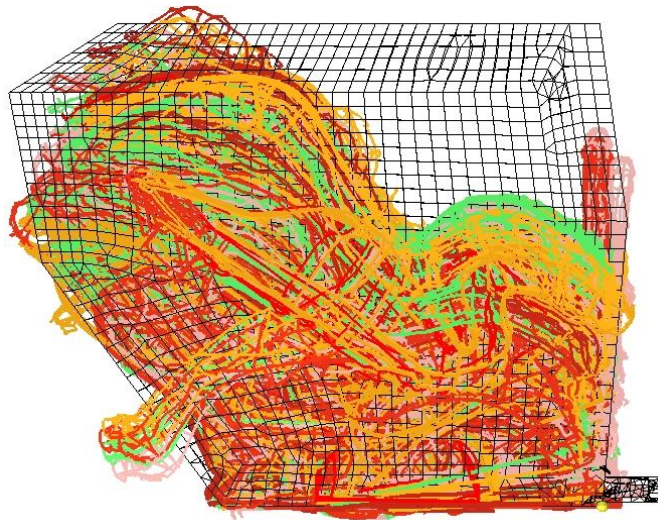

Figure 5. Envelope design that fits around RF CRS

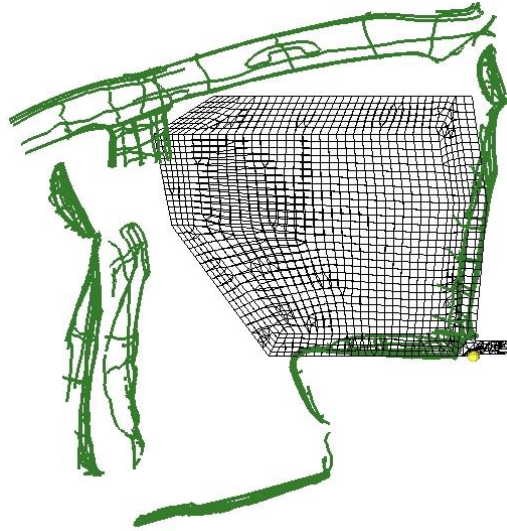

Figure 6. Placement of preliminary envelope in a sample vehicle.

For the forward-facing installations, all the CRS could be installed tightly in the vehicle. However, in some cases, there was a gap between the CRS and vehicle seat back, most often because of a reclined CRS position or a protruding vehicle head restraint. When choosing which FF installations to use to develop the FF envelopes, installations with a substantial gap were not included. Although a gap is allowable, it is not desirable. For each vehicle, reference points representing a 50 mm gap 10 cm below the top of the vehicle seat back and a 100 mm gap 10 cm above the H-point were virtually marked. Figure 7 and Figure 8 illustrate unacceptable gap levels when determining whether particular installations should be included in the envelope development, while Figure 9 shows installations where the lower gap is considered acceptable.

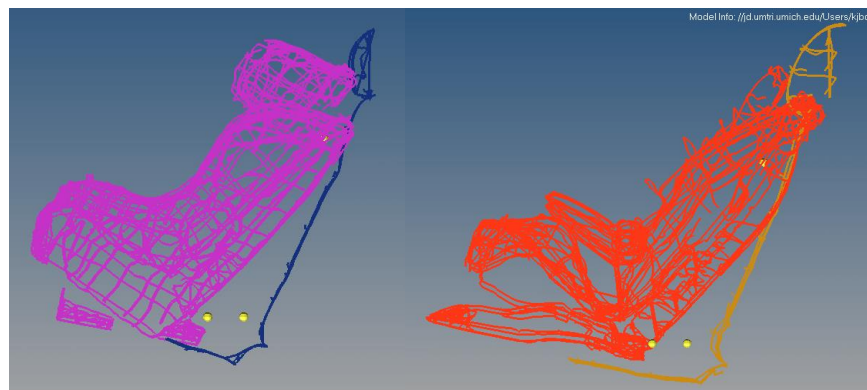

Figure 7. Lower gap too large (greater than 100 mm)

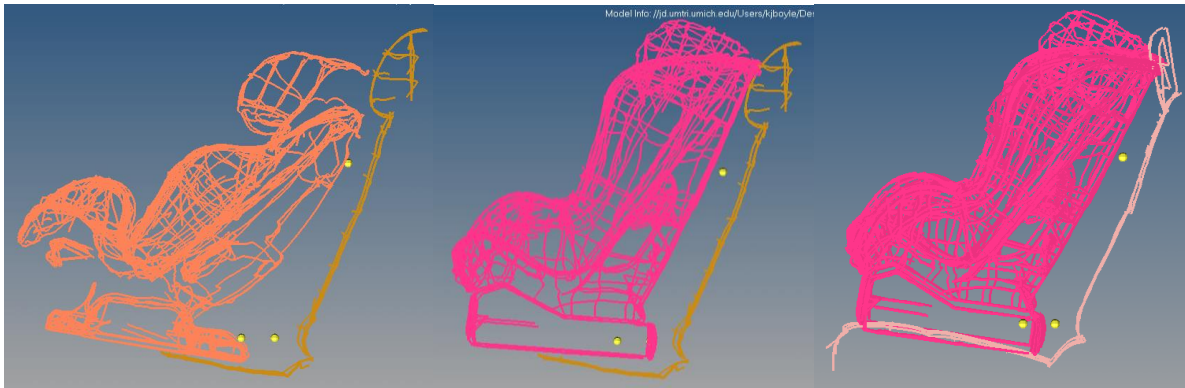

Figure 8. Upper gap too large (greater than 50 mm)

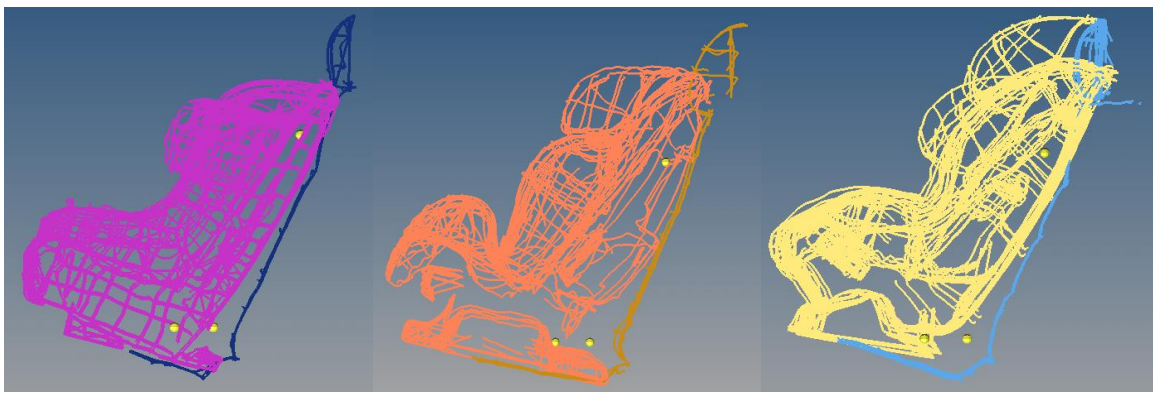

Figure 9. Lower gap acceptable (less than 100 mm).

For the design of the forward-facing envelopes, installations from the same four vehicles (highest and lowest cushion and seat back angles plus two intermediate angles) were used. Only installations with acceptable gaps were considered. The installed positions of the FF CRS were compared to the profiles of the ISO F1, F2, and F3 envelopes. Figure 10 compares the installations to the ISO F3 profile. For the 21 FF CRS and boosters measured, one fit in F2 and F2X, and five fit in F3 if the envelope was about 1 cm wider. The next step involved stretching the geometry of the ISO F3 envelop so it encompassed all the FF CRS as shown in Figure 11, except for the two tallest products that were outliers.

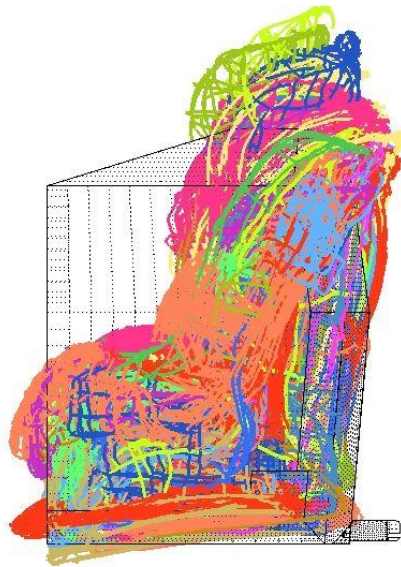

Figure 10. FF CRS installations in four vehicles compared to the ISO F3 envelope.

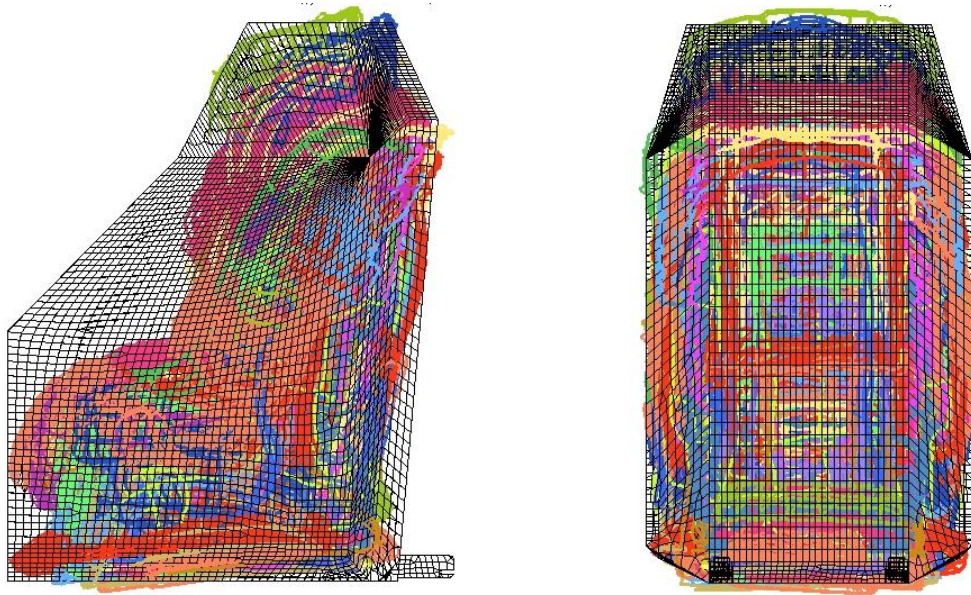

Figure 11. ISO F3 envelope “stretched” to fit around acceptable FF CRS installations in four vehicles.

RESULTS

The current document focuses on elements of the project related to design of fit envelopes. A companion paper, *Installed Positions of Child Restraints in the Rear Seats of Vehicles* (Klinich, Boyle, Malik, Manary, & Hu, 2015), describes findings relating to interference between CRS and different vehicles and how the installed positions of child restraints can vary.

Initial Proposed Designs

The initial thought was to develop three rear-facing envelopes and three forward-facing envelopes corresponding to the weight limit groupings shown in Table 3 and Table 4. However, a review of the sizes of CRS products within each category indicated that some CRS with the lowest weight limits were as large as CRS products with the highest weight limits.

The revised proposal for RF envelopes was to develop three RF envelopes: one with the same dimensions as R3, but about 1.5 cm wider, plus long and tall envelopes pictured in Figure 12 that would both be several centimeters wider than the ISO envelopes.

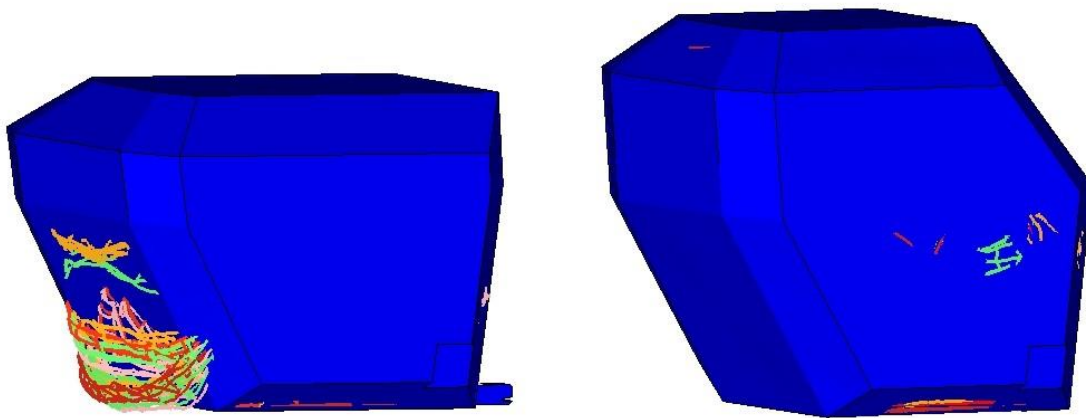

Figure 12. Revised proposal to develop long (left) and tall (right) RF CRS.

Further examination of the proposed long and tall U.S. envelopes showed that value of having two differently shaped large RF envelopes would be minimal. Figure 13 shows an overlay of the long (red), tall (blue), and large (green) envelopes. When comparing the proposed envelope profiles to the installed CRS profiles, most vehicles failing with the long envelope would also fail with the tall envelope. Thus, we made an additional revision (green) to use one envelope to cover the larger U.S. RF CRS.

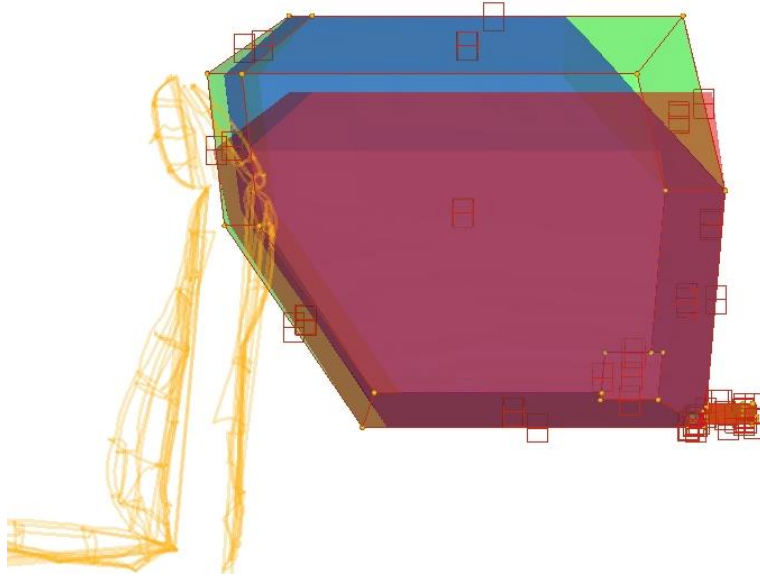

Figure 13. Comparison of proposed long (red), tall (blue), and large (green) envelopes.

The initial evaluations did not use any rear-facing only restraints without the base because they could not be installed with LATCH. Thus the development of envelopes did not consider any installations where the shell portion of a RF CRS could be installed using the seat belt, resulting in a smaller RF profile. Because this would be an option for parents transporting an infant in a small vehicle, the RF ISO R1 and R2 profiles were reconsidered as an option to define an envelope for a smaller RF CRS. To estimate the installed position of a RF only CRS without the base, the base was digitally removed from the installed position of the CRS (including base) and the shell portion was translated rearward until it contacted the seat back. Three RF only CRS were compared to ISO R1 as shown in Figure 14, and two of them fit within it in the XZ plane; the lateral dimension would also need to be increased by about 1.5 cm. Since R1 seemed to provide appropriate dimensions for a smaller RF envelope, R2 was not considered.

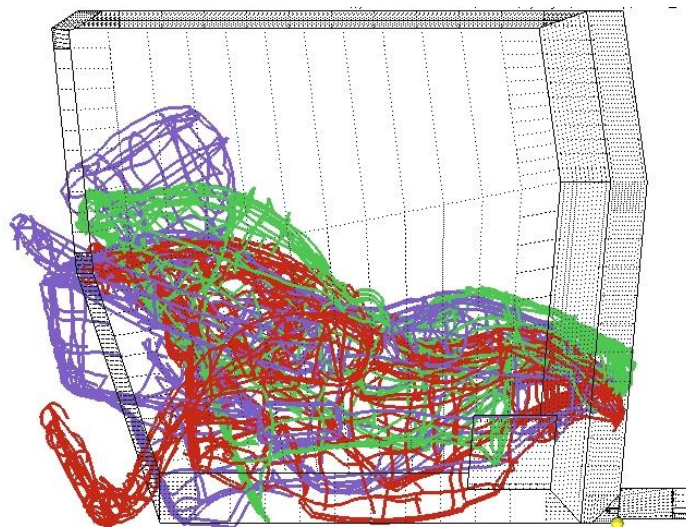

Figure 14. ISO R1 compared to three estimated installed profile of shell portion of a RF CRS.

Thus the proposal for the sizes of the RF envelopes are as follows:

- RS (ISO R1 dimensions plus 1.5 cm wider),
- RM (ISO R3 dimensions plus 1.5 cm wider), and
- RL designed to encompass the larger CRS currently being sold in the United States.

For the FF envelopes, a few of the FF CRS fit within the ISO F3 profile if it was 1.5 cm wider, but none fit within the ISO F1 or F2 profiles. The design of the smallest FF envelope uses the dimensions of the ISO F3 profile, but is 1.5 cm wider (FS). Two other FF envelopes were proposed as shown in Figure 15. Both FM and FL (FF medium and FF large) envelopes have a similar wider width than the FS, but different heights to span the range of FF U.S. product sizes.

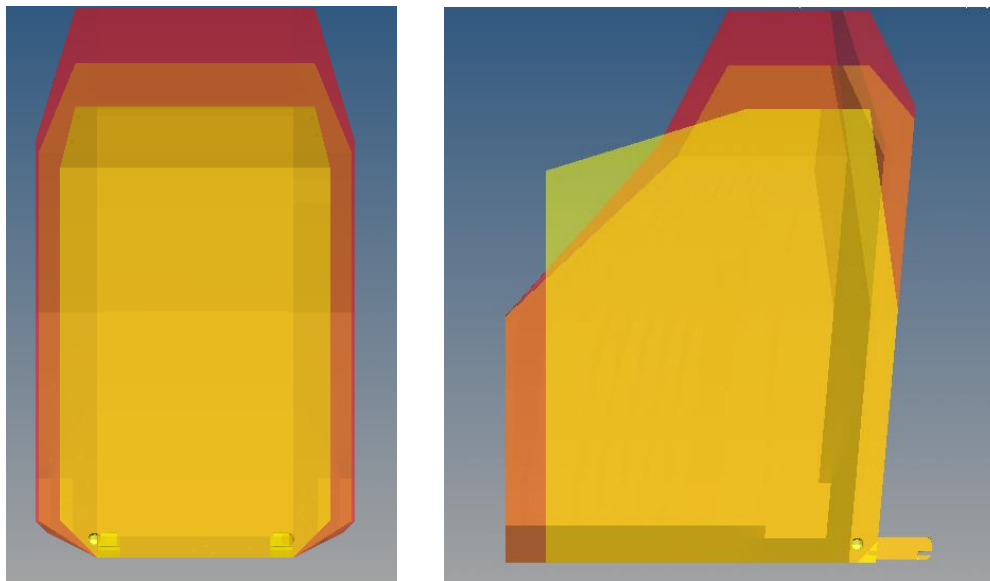

Figure 15. Proposals for FF envelopes: FS (yellow), FM (orange), FL (red).

Belt Path and Tether Zones

While the main goal of the envelopes is to promote compatibility between shapes of CRS and vehicles, achieving compatibility between LATCH belt paths and the vehicle lower anchors can also be considered. In addition, a means of securing the envelopes in the vehicle using flexible LATCH is needed, as the rigid LATCH anchors used with the ISO envelopes are not common in the United States.

When the CRS were installed in the vehicles, the locations of the lower anchors and the point on the CRS where the LATCH belt first contacted the child restraint were measured. The distance between the lower anchors and the belt path contact point, as well as the angle relative to horizontal, were calculated for each installation. Results are shown for RF CRS in each vehicle in Figure 16 and for each CRS manufacturer in Figure 17. The mean belt path angle is 47.7° with standard deviation (SD) of 9.6°. Of the 184 outboard RF installations using flexible LATCH, 74 percent had angles ranging from 38° to 58°. There was a significant difference in angle ($p < 0.0001$) between rear-facing only (43°) and rear-facing convertible CRS (52°). For the distance between lower anchor and belt path contact point, the mean

value for convertibles was longer (248 mm, SD 42) than for rear facing only (156 mm, SD 29; $p < 0.0001$). Distance does not vary significantly with vehicle ($p = 0.413$). However, mean angle does vary with vehicle ($p < 0.0001$), with mean values ranging from 40° in V10 to 54° in V07. Both angle and distance varied significantly with CRS manufacturer ($p < 0.0001$). The maximum and minimum mean distances range from 88 mm to 283 mm and the mean angles range from 25° to 63°. The variations are greater between CRS manufacturers than between vehicles.

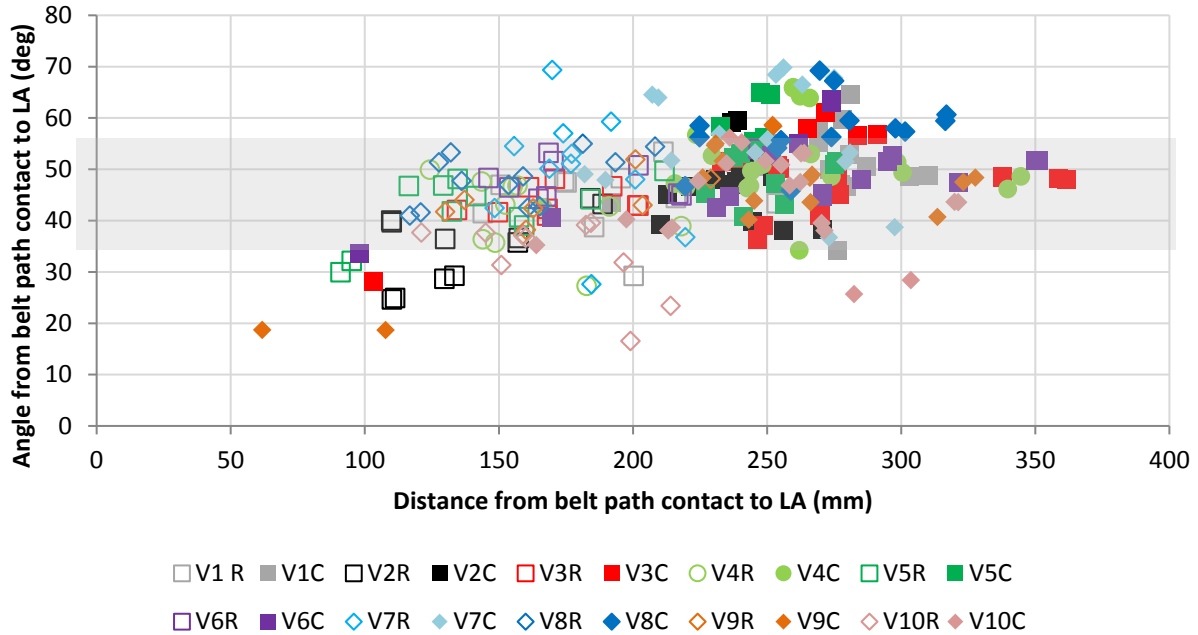

Figure 16. Angle versus distance of belt path contact location to LA for RF 2L and 2C installations by vehicle type. Shaded area represents mean \pm 1 SD corridor from 37° to 57°. Open (R) =rear-facing only, solid (C) =convertibles, squares=SUV, circle=minivan, diamonds=sedans. V1 through V10 correspond to vehicles listed in Table 12.

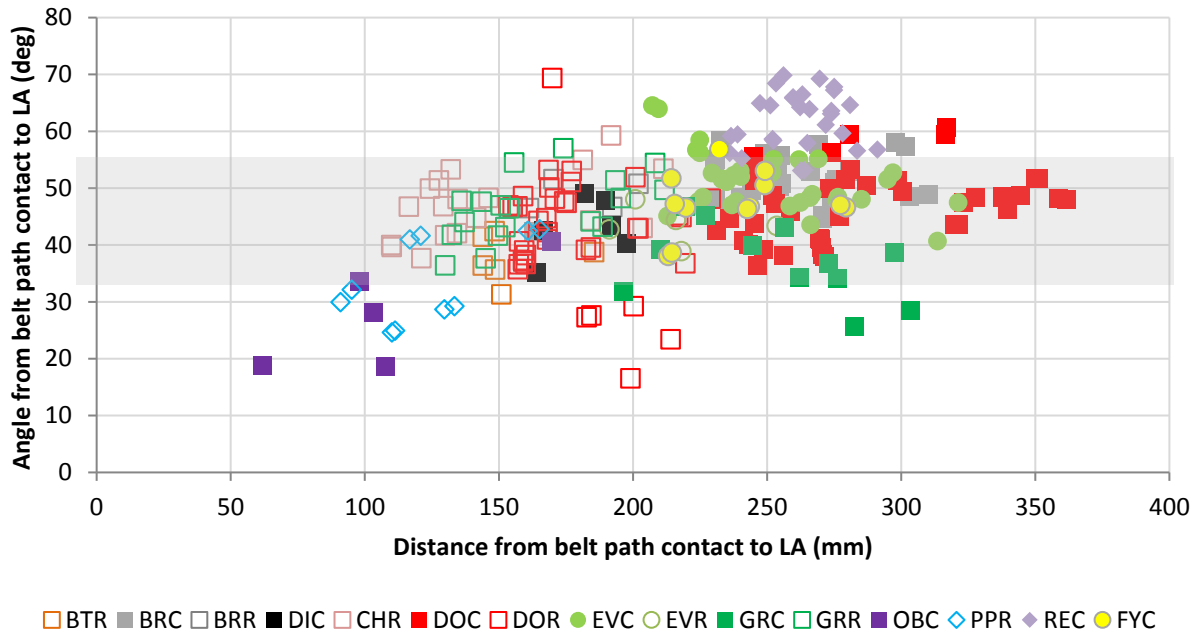

Figure 17. Angle versus distance of belt path contact location to LA for RF 2L and 2C installation by CRS manufacturer. Shaded area represents mean +/-1 SD corridor from 37° to 57°. Open (R) =rear-facing only, solid (C) =convertibles. BT=BabyTrend, BR=Britax, DI=Diono, CH=Chicco, DO=Dorel, EV=Evenflo, GR=Graco, OB=Orbit Baby, PP=PegPerego, RE=Recaro, FY=FirstYears

Results for FF CRS are shown in Figure 18 by vehicle and Figure 19 by CRS manufacturer. The mean angle is 60.2° (SD 9.1) and the mean distance was 220 mm (SD 30). The angle was steeper for FF only than convertibles (67° versus 58°, $p < 0.0001$), but the distance was shorter (195 mm versus 227 mm, $p < 0.0001$). Out of 218 installations in 2L and 2C positions, 73 percent had angles to contact point between 50° and 70°. Again, there is more clustering by CRS manufacturer than by vehicle. Mean values of distance in vehicles varied from 205 to 239 mm, while angles varied from 52° to 66°. For CRS manufacturers, mean values of distance ranged from 176 to 248 mm, while angles varied from 54° to 66°.

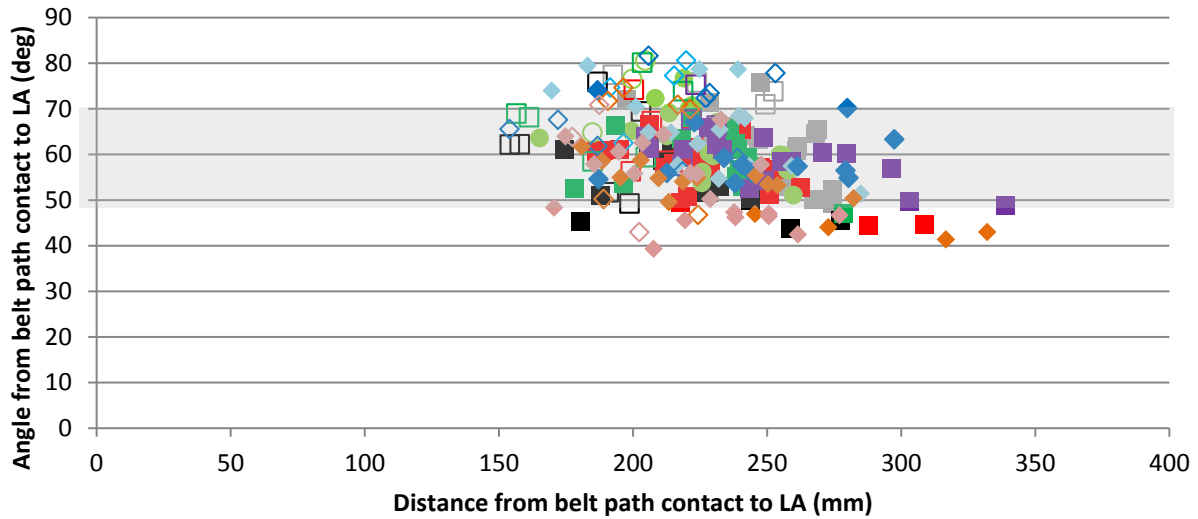

Figure 18. Angle versus distance of belt path contact location to LA for FF 2L and 2C installations by vehicle type. Shaded area represents mean +/- 1 SD corridor from 50° to 70°. Open (R) =rear-facing only, solid (C) =convertibles, squares=SUV, circle=minivan, diamonds=sedans. V1 through V10 correspond to vehicles listed in Table 12.

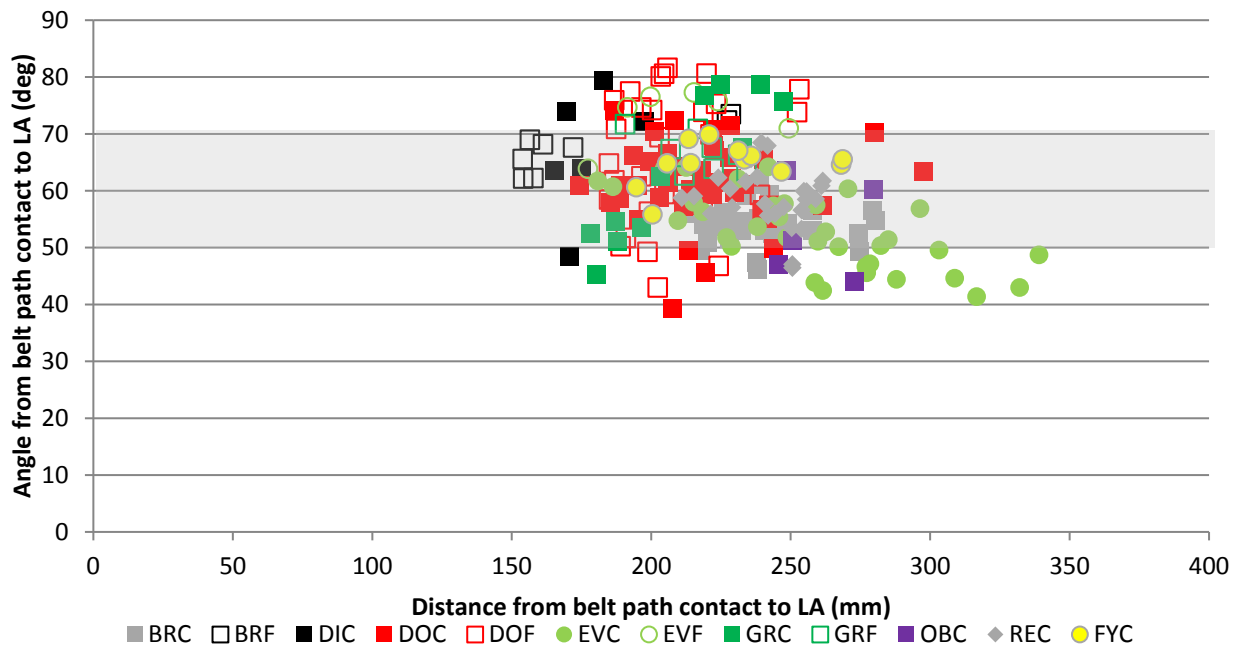

Figure 19. Angle versus distance of belt path contact location to LA for FF 2L and 2C installation by CRS manufacturer. Shaded area represents ~mean +/- 1 SD corridor from 50° to 70°. Open (R) =rear-facing only, solid (C) =convertibles. BT=BabyTrend, BR=Britax, DI=Diono, CH=Chicco, DO=Dorel, EV=Evenflo, GR=Graco, OB=Orbit Baby, PP=PegPerego, RE=Recaro, FY=FirstYears

Based on these data, attachment points for flexible LATCH belts on the envelopes were chosen as shown in Figure 20 for the RF envelopes and Figure 21 for the FF envelopes. The LATCH belt attachment locations were chosen to be near the center of the angle range on the belt path zone, but also close to the frame support of the envelope so they could be physically mounted to a rigid component. An additional frame member was added to RF_{veh} later so that the LATCH belt attachment point was closer to the front opening of the envelope and tightening was easier. For the RF envelopes, the point produces an angle of 48 degrees and a distance of 136 mm, while for the FF envelopes, the point produces an angle of 62 degrees and a distance of 175 mm. The attachment points consider a vehicle cushion angle of 15°. In addition, a target zone for belt path contact point is included on each envelope, spanning angles from 37° to 57° on the RF envelopes and 50° to 70° on the FF envelopes. To improve compatibility, the belt path or flexible LATCH belt attachment point should fall within these target zones.

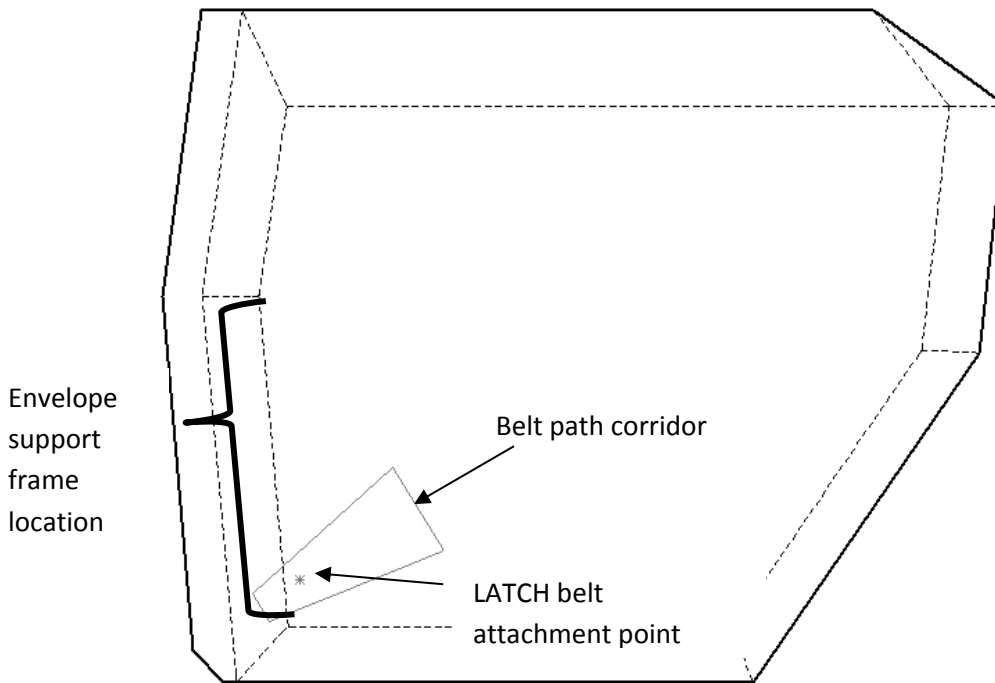

Figure 20. Drawing of attachment points and belt path corridors for RF envelope.

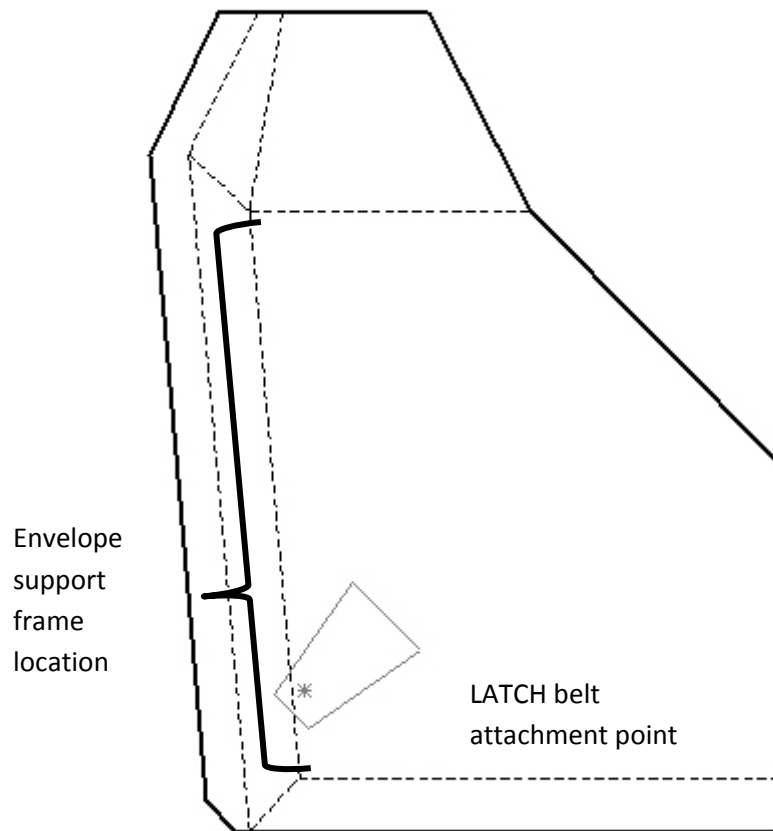

Figure 21. Drawing of attachment points and belt path corridors for FF envelope.

Because flexible LATCH belts are being used to secure the envelopes in vehicles to evaluate compatibility, the forward-facing envelopes should also include a tether strap. Figure 22 shows the profiles of the three FF envelopes, overlaid with the tether attachment points from each CRS install. A tether location marked in Figure 22 was selected to represent a common location that could be used with all three envelopes.

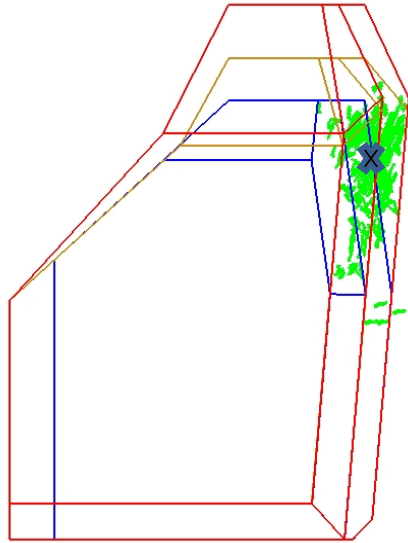

Figure 22. Tether location that can be used with all three envelopes representing common attachment location marked with X.

First Prototype Evaluation

The first prototype constructed used the RM envelope design as shown in Figure 23. It was constructed of 16-gauge cold rolled sheet metal, measuring 0.0598 in thick. Thin metal was used so the same fixture could be used to check vehicles and CRS. The fixture includes a fold-out base prop which sets it to 15 degrees, the cushion angle of the proposed FMVSS No. 213 revised bench, as well as the mean value of vehicle seat cushions tested in the study. This feature allows the user to place the fixture on a horizontal surface, and check that the CRS fits within the envelope at an allowable angle using a simulated realistic cushion angle. The lower cutout is a suggested zone for positioning the belt path. To complete the geometry, the envelope would also need a “lid” component that was not constructed.



Figure 23. Initial RM prototype.

Of the 31 child restraints measured and installed in vehicles for this project, 27 can be used rear-facing. To evaluate the first RM prototype envelope, each CRS was inserted under all the allowable recline angles. Table 13 details which seats passed, failed, and the reason for failure. Twelve CRS fit within RM; one seat could fit using the primary but not the secondary recline.

Table 13. CRS Fit in Prototype RM Envelope

Brand	Model	Primary recline	Secondary Recline	Reason for failure
Orbit Baby	Toddler Car Seat	Pass	N/A	
Sunshine Kids	Radian 80SL	Fail	N/A	Doesn't reach bottom
Compass	True Fit	Fail	N/A	Too wide
Britax	Boulevard CS	Pass	N/A	
Evenflo	Triumph Advance	Fail	N/A	Too wide
Evenflo	Symphony	Fail	N/A	Too wide
Graco	Comfort Sport	Pass	N/A	
Safety 1st	Alpha Omega Elite	Fail	N/A	Too wide
Eddie Bauer	Deluxe 3-in-1	Fail	N/A	Too wide
Safety 1st	Scenera	Fail	N/A	Not level (24°)
Maxi-Cosi	Pria	Fail	Fail	Too wide
Safety 1st	Guide 65 Sport	Pass	Fail	Not level
Evenflo	Tribute LX	Pass	N/A	
Graco	My Ride 65	Fail	N/A	Too wide
Recaro	ProRIDE	Fail	N/A	Not level (13°)
The First Years	True Fit SI	Fail	Fail	Too wide
Baby Trend	Flex-Loc	Fail	Fail	Carry handle
Britax	B-SAFE	Pass	N/A	
Chicco	KeyFit 30	Pass	N/A	
Chicco	KeyFit	Pass	N/A	
Cosco	Comfy Carry	Fail	N/A	Doesn't reach bottom
Maxi-Cosi	Mico	Pass	N/A	
Maxi-Cosi	Prezi	Fail	Fail	Doesn't reach bottom
Evenflo	Nurture	Pass	N/A	
Graco	SnugRide Classic Connect	Pass	N/A	
Graco	SnugRide Classic Connect 35	Pass	N/A	
Peg Perego	Primo Viaggio SIP	Pass	N/A	

Different shades correspond to different reasons for failure

Preliminary evaluation with the prototype identified some issues with the test procedure as well as the fixture design. The first relates to the carry handle usually found on rear-facing only seats. The child restraint manuals each specify which handle positions are permissible for travel, and all but one of the

child restraints was able to fit with the handle in at least one of the allowable positions. When the handles are in the upright carry position, they extend past the top of the envelope to some extent, but most would fit with the lid in place (see Figure 24). In the test procedure being drafted, the proposed criteria related to the carry handle is that a CRS would “fit” in an envelope if it can fit with the carry handle in at least one allowable position, but does not have to fit at all allowable positions.



Figure 24. Example of RF-only CRS that would fit with carry handle in upright position if lid was used.

A requirement for the CRS to fit is that it must fit within the envelope at an allowable angle. There are a wide variety of level indicators as shown in Figure 25. Some indicators are lines that should be parallel to the ground, some are bubble levels that show an acceptable range, and others are pendulum types that show different colors to indicate acceptable versus unacceptable angles. The bubble and pendulum types have a built-in tolerance for acceptable angles, but the tolerance when using a line-type indicator is not clear. To develop a tolerance for the level lines, the range of allowable angles in the “acceptable” zone of other types of indicators was measured. Values ranged from 7 to 18 degrees, with an average of 12°. For testing with level line indicators, the proposed tolerance for the CRS to fit within the envelope is +/- 5° from horizontal.



Figure 25. Examples of different level indicators.

A few CRS specified a different angle for different occupant weights, with a more upright angle for heavier children, as shown in Figure 26. None of the CRS fit in the RM envelope at the more upright angle, although one CRS did fit in the RM envelope at the more reclined angle. For a CRS to “fit” in a particular size of envelope, the recommendation is that it must fit under all of its configurations.

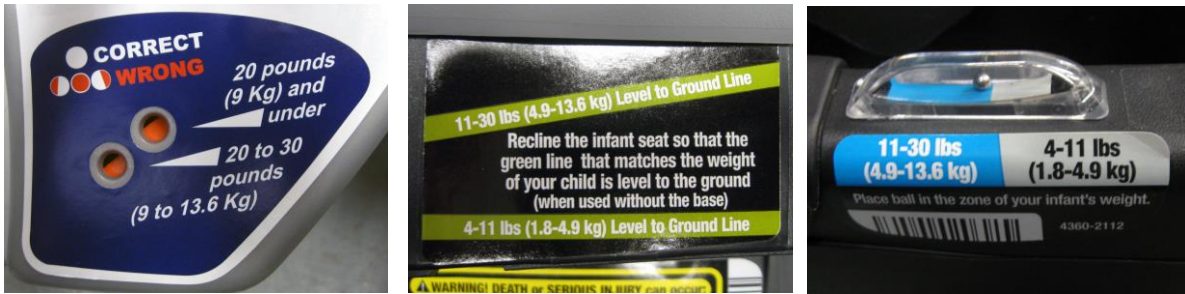

Figure 26. Examples of different recline levels for different child weights.

Several restraints were a very tight fit within the envelope. Some clearly did not fit, and some were very close to sliding in but did not. Others barely fit, but made the box flex a little to allow for their bulk. This raised questions about how much force should be used to make a seat fit in the box. In addition, some CRS were hampered by the fabric covers bunching up as the CRS slid down into the envelope. When some CRS were evaluated with and without the fabric covers on the side components, one of them could fit in the box that had previously been designated as too wide (Figure 27).

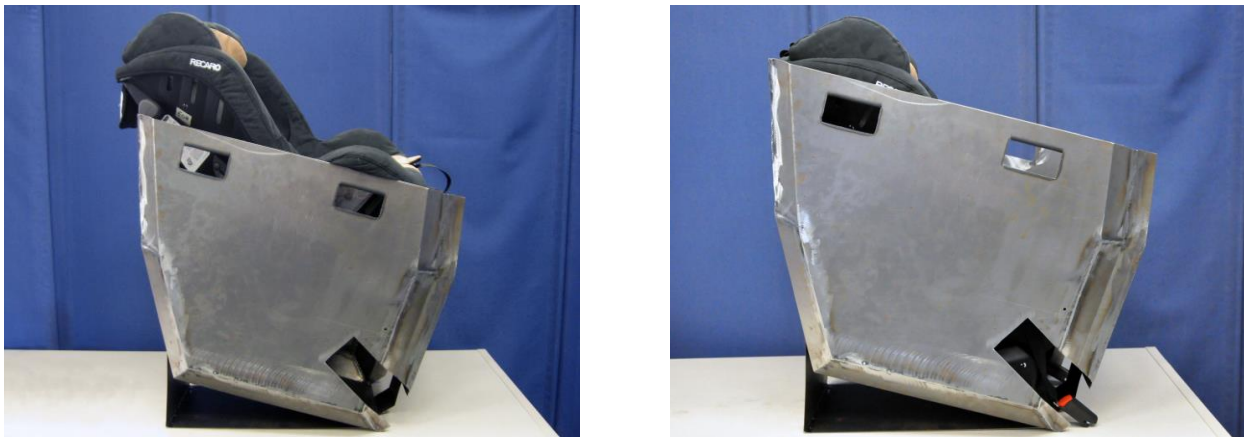

Figure 27. One CRS did not fit with fabric covers in place (left) but did when covers over side elements were shifted (right).

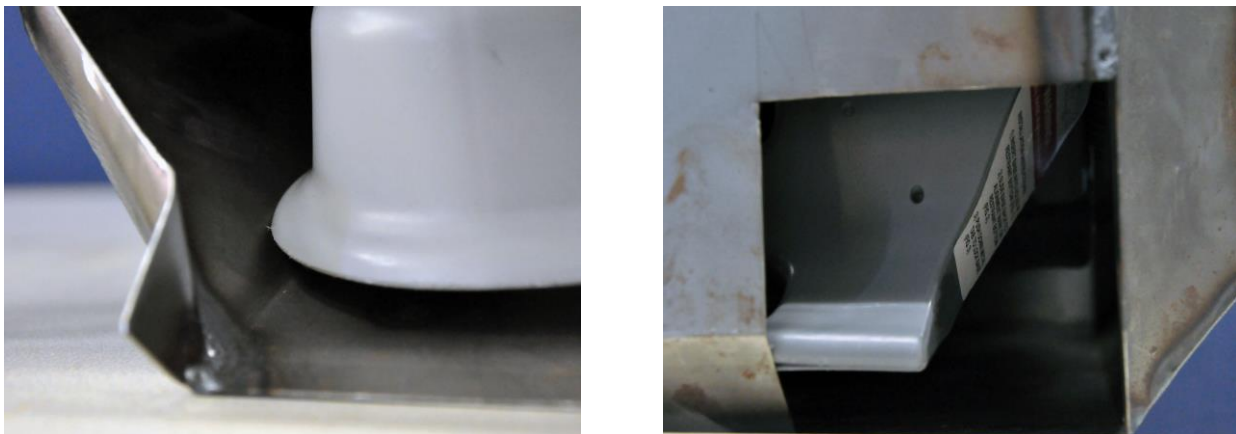

Figure 28. Some CRS did not contact the bottom of the envelope.

Another issue was that some of the CRS did not come into full contact with the bottom of the box. Some did not contact the bottom of the box at all, some contacted only in the front, and some contacted the angled portion just above the bottom (Figure 28). The proposed criterion is that at least some of the CRS bottom surface must contact the base of the envelope for it to be considered “fitting.” It was somewhat difficult to determine how much of the base contacted the bottom of the box with the current prototype design.

The initial project proposal planned to use the same fixtures for evaluating CRS and vehicles. This was the motivation for choosing sheet metal for the material, so that testing the inside and outside of the envelope provided the closest dimensions possible. However, feedback provided by NHTSA after initial prototype testing indicated that it would be acceptable (and possibly preferable) to develop separate boxes for evaluating CRS and vehicles.

Revised Designs

Based on issues identified through initial prototype testing, an alternate design strategy was taken. Figure 29 illustrates the design concept for a set of nesting envelopes that would be used to evaluate RF CRS. Instead of inserting the CRS through a top opening and adding a “lid,” the CRS would be placed through the side into an envelope representing the envelope design, except for the contoured portion of one side (shown by front view with dashed line overlaid in Figure 29). The new design concept involves constructing a box representing the largest RF envelope (RL). Then there are two sets of inserts that would slide in to convert the RL envelope into RM and RS, which would lock with magnetic connectors.

To check fit, the CRS is inserted. If the base of the CRS extends beyond the base of the envelope, it would not fit. Either the base is too wide relative to the base of the envelope, or the upper structure of the CRS is wide enough to shift the CRS centerline past the centerline of the envelope.

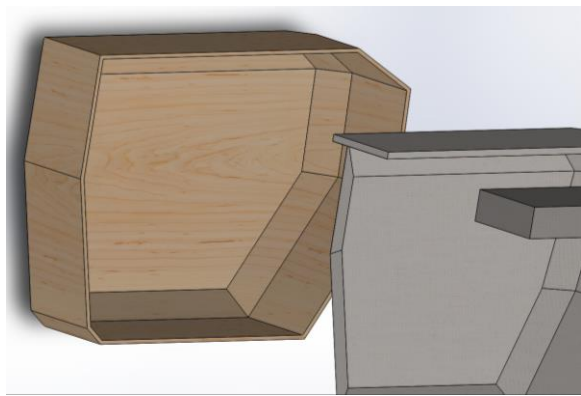

Outer envelope RL

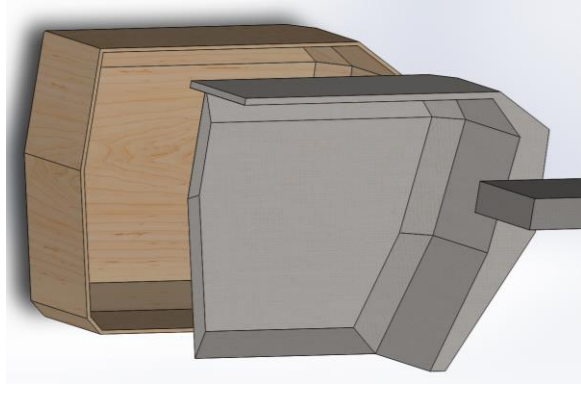

Insert to convert R4 into RM

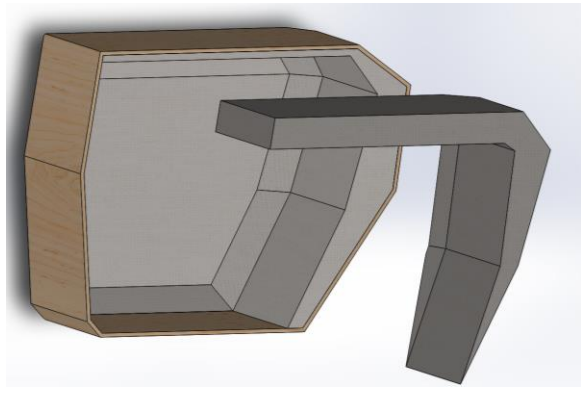

Insert to convert R4+RM into RS

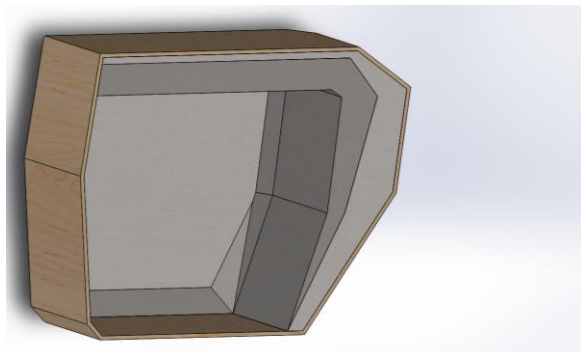

Assembled RS

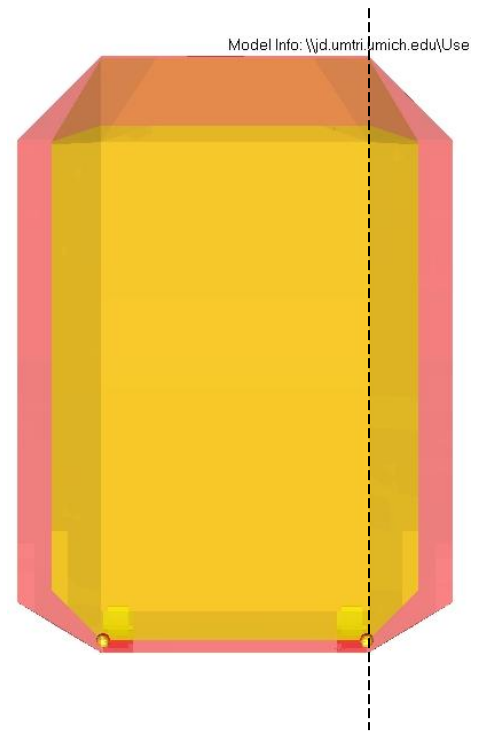

Figure 29. Concept for reconfigurable RF_{CRS} envelope; drawing with dashed line indicates lateral extent of envelope.

There are several potential advantages to this alternate design.

- Easy to see if CRS fits within envelope at an acceptable angle
- Easy to see if the CRS bottom contacts the bottom of envelope
- One large box with inserts takes up less storage space than three separate boxes
- The question of how much force to apply to place the CRS within the envelope becomes inconsequential. The CRS is placed within the envelope; gravity will not affect if its centerline reaches the fixture centerline or not
- It will be less strenuous for the tester to insert the CRS from the side than from the top (somewhat an issue after a full day of testing)
- Leaving the fabric covers in place will pose less of an issue when inserting from the side

A similar modular concept for the FF_{veh} envelope is shown in Figure 30 and Figure 31. An envelope base is installed in the vehicle using flexible LATCH. Different components are added to the base using magnetic connectors to represent the FS, FM, and FL envelopes.

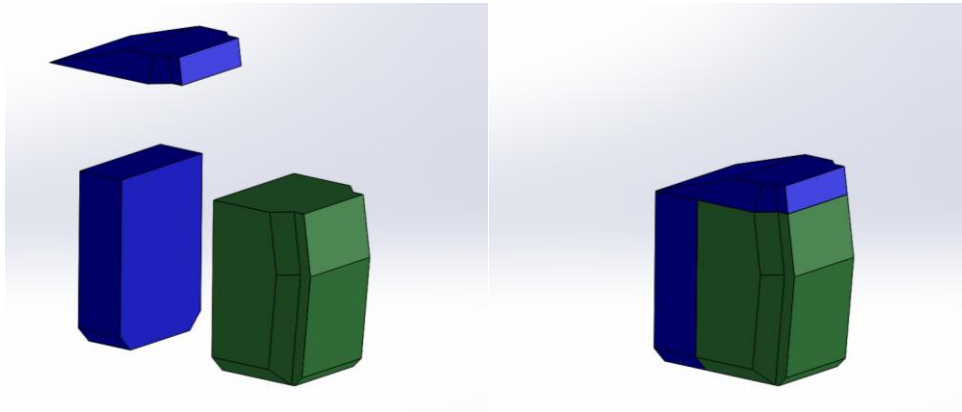

Figure 30. FF_{veh} base (green) plus two components added to create FS.

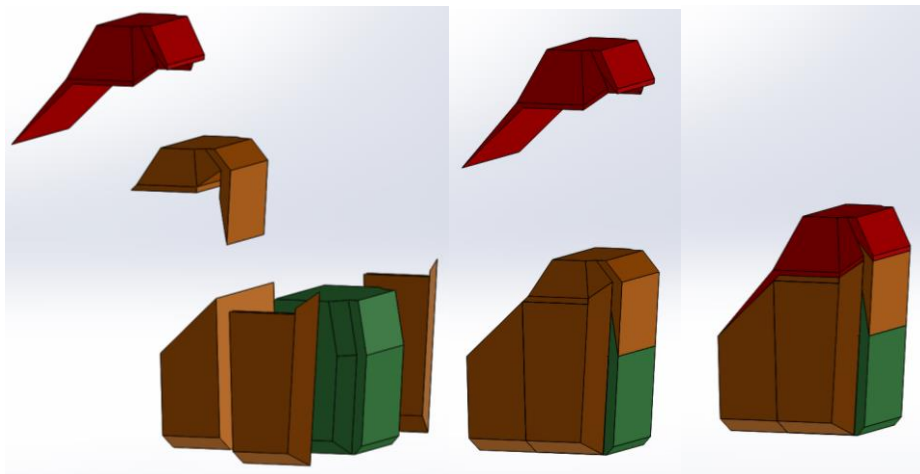

Figure 31. FF_{veh} base (green) plus four components to create FM, and one more component to create FL.

For the FF_{veh} design, the advantage of the modular design is that it should be easier to insert components through the door rather than one large envelope. The modular components would also take up less storage room and be lighter to maneuver. Once construction began, we noted that the contour of the FS box may still pose challenges for maneuvering in and out of the rear vehicle compartment. In addition, the front upper portion of the ISO box specifies space substantially outside of the space that forward-facing U.S. child restraints occupy as shown in Figure 32. If the XZ dimensions of the ISO box are maintained, the smallest envelope would not be able to nest within the larger envelopes. As a result the previous design of the FS envelope was modified to trim the top forward section (in blue) so its profile matches the front profile of the other two boxes shown in red.

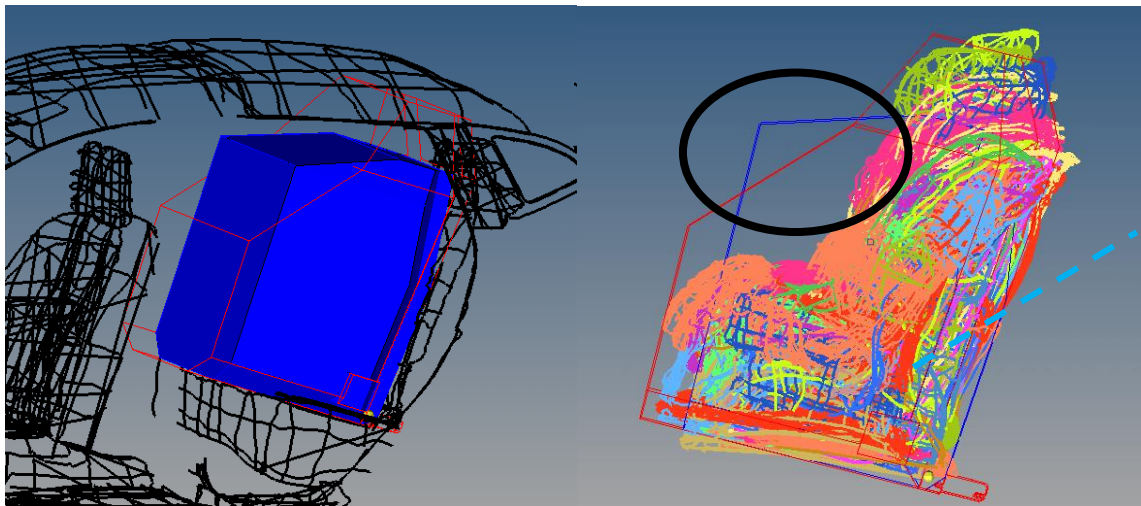

Figure 32. Original proposed design of FS envelope falls outside space occupied by U.S. CRS and could cause issues placing in rear seat.

Initial testing with the nesting prototype envelopes indicated that the largest forward-facing envelope was too large to fit in a minivan. Since this seemed unreasonable, the top contour was revised so it could fit in a minivan second row.

In June 2015, UMTRI hosted a workshop to introduce industry representatives from vehicle and child restraint manufacturers to several different research projects, including the envelopes. Participants were asked to provide feedback regarding the envelope designs and procedures. Two main revisions were implemented based on industry input after consultation with NHTSA.

First, vehicle manufacturers commented that the fore-aft dimensions of the bases of the larger envelopes were rather long. Since child restraint manufacturers typically recommend that at least 80 percent of the CRS footprint be supported by the vehicle seat, allowing CRS to have a long footprint might promote longer seat cushions in vehicle rear seats. Since other research efforts have shown a benefit of shorter rear seats for older child passengers (Hu, Manary, Klinich, & Reed, 2013), envelope designs that encourage longer seat cushion lengths would not be desirable.

In response, the profiles of the measured RF and FF CRS were compared to the envelope profile as shown in Figure 33 and Figure 34. For the RF CRS, none of the bottom surfaces extended forward past

the bottom of the RS envelopes. Therefore, the RL envelope could be modified to have a shorter bottom fore-aft dimension as indicated by shifting the front surface rearward to the dimension indicated with a dashed line. For the FF CRS, only one product extended past the bottom of the FS and FM envelopes. Thus the FL envelope could also be changed so its bottom fore-aft dimension matches the other two without causing many CRS to not fit.

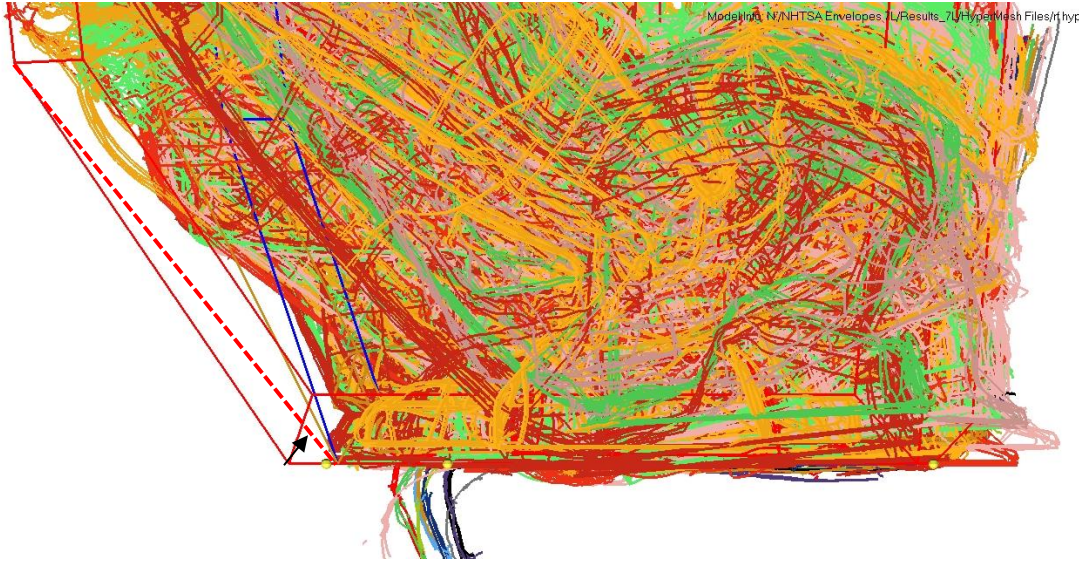

Figure 33. RF CRS geometries overlaid with envelopes. Dashed line indicates modification to shorten bottom envelope dimension.

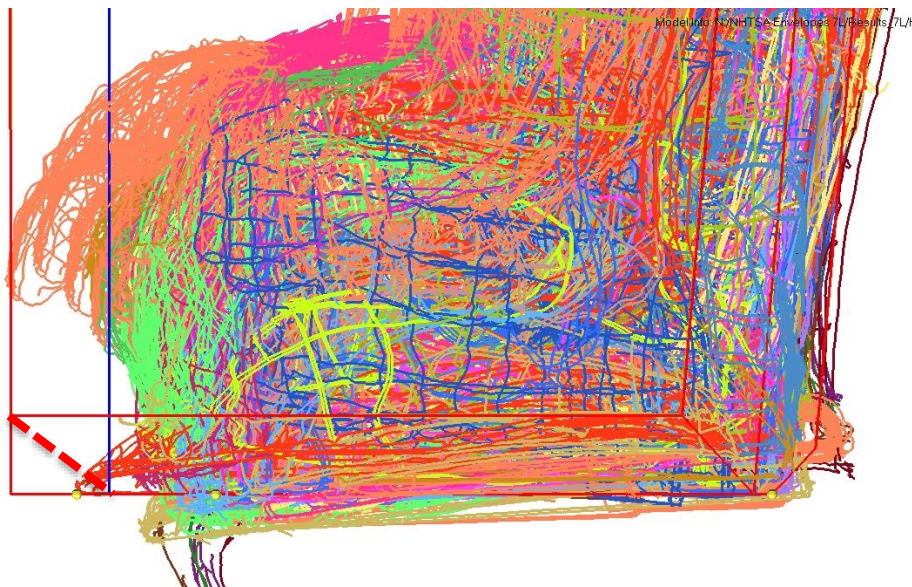

Figure 34. FF CRS geometries overlaid with envelopes. Dashed line indicates modification to shorten bottom envelope dimension.

Second, vehicle manufacturers also expressed concern about the size of the FL and FM near the top, as CRS fitting into the upper portions of the envelope would have potential for substantial interaction with deploying curtain airbags. The shapes of the FM and FL envelopes were compared to the largest child restraints measured as shown in Figure 35 on the left. The vertical locations of the tops of the envelopes were selected to fit the largest two (for FL) and multiple other CRS (for FM). However, the illustration shows that the tops of the envelopes could be contoured more while still accommodating the largest CRS. As a result, the FM and FL envelopes were modified as shown on the right of Figure 35.

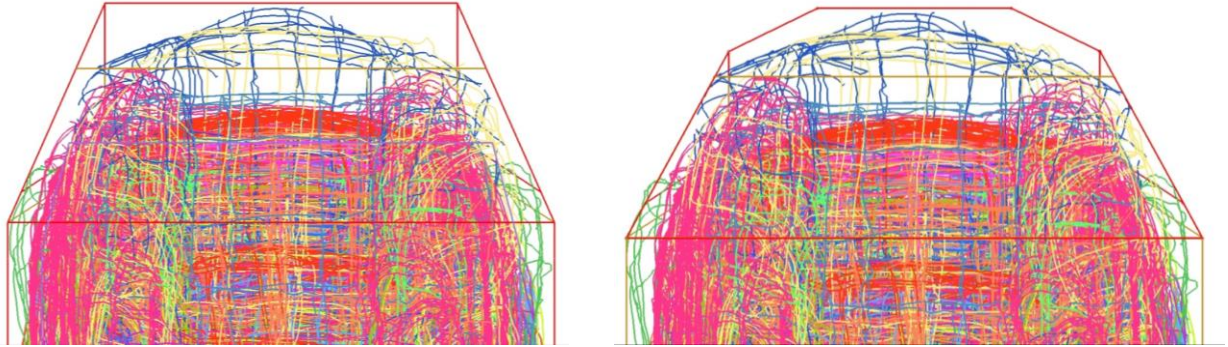

Figure 35. FL (red) and FM (gold) top contours before (left) and after (right) incorporating industry feedback.

Final Designs

Overlays of the final envelope designs are shown in Figure 36 for the FF designs and Figure 37 for the RF designs. Photos of the four sets of physical nesting envelope designs are included in Appendix A.

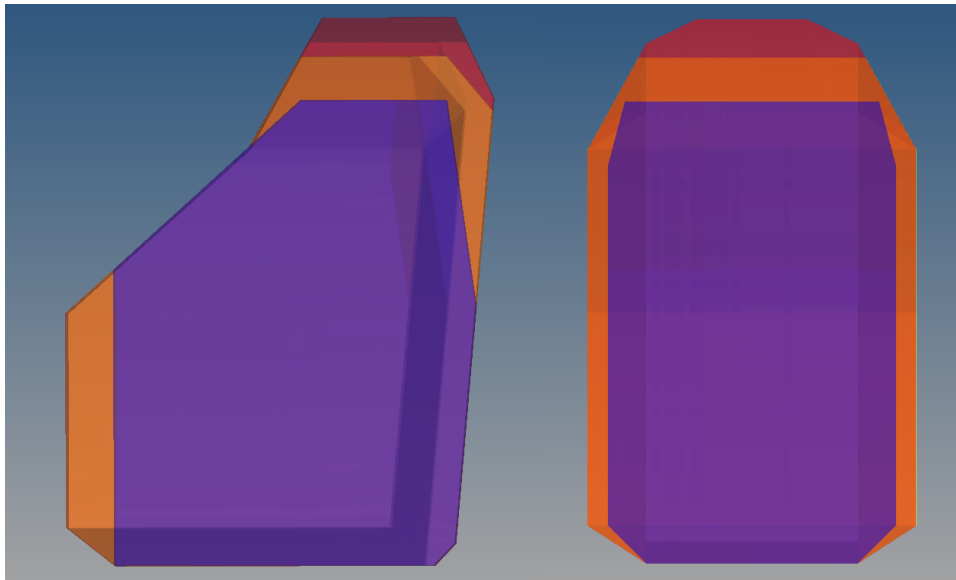

Figure 36. Final dimensions of FF envelopes.

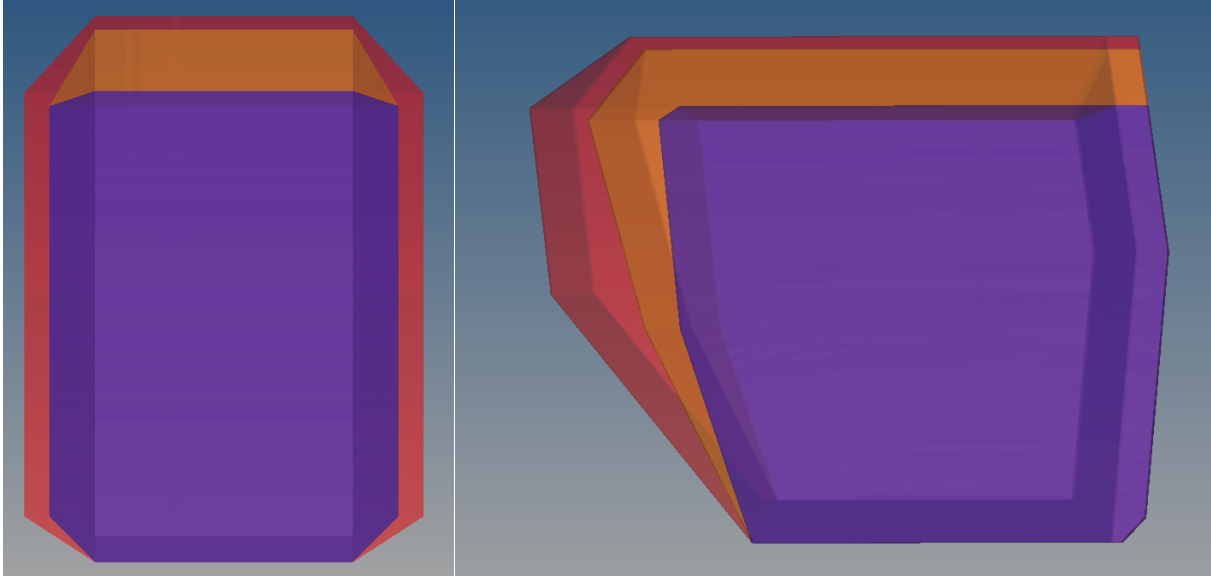

Figure 37. Final dimensions of RF envelopes.

Compatibility Assessment

Checking for CRS fit into the envelopes or fit of the envelope volume shape into vehicle seating positions can be done virtually using CAD or physically using the sets of modular fixtures. Results below are based on testing with the physical envelopes. They were performed with the version of the envelopes before manufacturer suggestions were implemented except as noted.

RF CRS in RF_{CRS}

Twenty-six RF CRS were evaluated in the RS, RM, and RL envelopes. Instructions used to check fit are included as Appendix B. Key criteria for assessing fit in RF envelopes were that:

- The CRS could be placed in the envelope.
- CRS was at an acceptable angle. Tolerance of +/- 5 degrees used if angle judged using horizontal line.
- The bottom surface of the CRS did not extend past the edge of the envelope base.
- The bottom surface of the CRS contacted the envelope base. In addition, the bottom structure of the CRS did not extend past the bottom angled portion of the envelope (indicated in Figure 38).
- Handle fit in at least one position usable for travel, but not all.
- RF belt path aligns with target belt path zone.



Figure 38. The bottom of the RF_{CRS} structure must fall below the dashed orange line.

Results are shown in Table 14, while photos are included in Appendix C. Main reasons why CRS did not fit were: too big to fit in envelope, the CRS could not fit at an acceptable angle, insufficient bottom contact (IBC), or the CRS was too wide to fit.

Twelve CRS did not fit in any of the envelopes. One CRS fit in the small envelope under all configurations. Four others fit in the small envelope without the base, but only in the RM envelope when the base was used. Five CRS fit in the RM envelope and four others fit in the RL under all configurations.

Table 14. Evaluation of RF CRS in envelopes.

√: Fits, IBC: insufficient bottom contact, Angle: nonacceptable angle

Brand	Model	RS	RM	RL
Baby Trend	Flex-Loc, with base (min and max)	Too big	√	√
Baby Trend	Flex-Loc, without base (min and max)	√	√	√
Britax	Boulevard CS	Too big	Wide	IBC
Britax	B-SAFE, with base	Too big	√	√
Britax	B-SAFE, without base	Angle	√	√
Chicco	KeyFit 30, with base	Angle	√	√
Chicco	KeyFit 30, without base	Angle	√	√
Chicco	KeyFit, with base	Too big	√	√
Chicco	KeyFit, without base	Angle	√	√
Compass	True Fit, R1 (min)	Angle	Angle	IBC
Compass	True Fit, R2 (max)	Too big	Angle	IBC
Cosco	Comfy Carry, with base	Too big	√	√
Cosco	Comfy Carry, without base	√	√	√
Eddie Bauer	Deluxe 3-in-1	width	Width	IBC, width
Evenflo	Nurture, with base	Too big	√	√
Evenflo	Nurture, without base	IBC	√	√
Evenflo	Symphony, R1 (min)	Too big	Angle	√
Evenflo	Symphony, R2 (max)	Too big	Too big	√
Evenflo	Tribute LX	Angle	Angle	IBC
Evenflo	Triumph Advance	Too Big	Angle	Width
Graco	Comfort Sport	Too big	Angle	Angle
Graco	My Ride 65	Too big	√	√
Graco	SnugRide Classic Connect 35, base	Too big	√	√
Graco	SnugRide Classic Connect 35, no base	√	√	√
Graco	SnugRide Classic Connect, base	Too big	√	√
Graco	SnugRide Classic Connect, no base	√	√	√
Maxi-Cosi	Mico, with base	Too big	Too big	√
Maxi-Cosi	Mico, without base	Angle	√	√
Maxi-Cosi	Prezi, R1, with base (min)	Too big	IBC	√
Maxi-Cosi	Prezi, R1, without base (min)	IBC	Angle	√
Maxi-Cosi	Prezi, R2, with base (max)	Too big	IBC	√
Maxi-Cosi	Prezi, R2, without base (max)	IBC	Angle	√
Maxi-Cosi	Pria, R1 (min)	Angle	IBC	√
Maxi-Cosi	Pria, R2 (max)	Too big	√	√
Orbit Baby	Toddler Car Seat	Too big	Too big	Width
Peg Perego	Primo Viaggio SIP, with base	Too big	Width	Width

Brand	Model	RS	RM	RL
Peg Perego	Primo Viaggio SIP, without base	Too big	IBC	IBC
Recaro	ProRIDE	Width	Width	IBC
Safety 1st	Alpha Omega Elite	Too big	Angle	IBC, width
Safety 1st	Guide 65 Sport, R1	√	√	√
Safety 1st	Guide 65 Sport, R2	√	√	√
Safety 1st	Scenera	Angle	Angle	Angle
Sunshine Kids	Radian 80SL	IBC	IBC	IBC

Figure 39 compares the installed position of the Recaro ProRIDE in one of the test vehicles compared to its position in the RL envelope. Although it could fit in the RL envelope, when it was placed at an acceptable angle, the bottom surface was higher than the allowable line, causing a gap. In the vehicle, there was a gap between the seat cushion and bottom of the CRS as well.



Figure 39. Recaro Proride has similar fit problem in FL and vehicle.

Two of the RF CRS tested frequently could not be installed in vehicles at an acceptable angle as shown in Figure 40. As shown in Figure 41, they also did not pass the bottom contact or angle requirements in FL.



Figure 40. RF CRS that could not be installed at an acceptable angle in the vehicle.



Figure 41. Same RF CRS did not meet bottom contact (left) or angle criteria (right).

FF_{CRS}

Twenty-one FF CRS were evaluated in the FF_{CRS} envelopes. Criteria for assessing fit include:

- The CRS could be placed in the envelope.
- CRS was at an acceptable angle.
- The bottom surface of the CRS did not extend more than 4 cm past the edge of the envelope base.
- The bottom surface of the CRS contacted the envelope base. In addition, the bottom structure of the CRS did not extend past the bottom angled portion of the envelope

- Gap less than 50 mm at upper location and less than 100 mm at lower location as indicated in Figure 42.
- FF belt path aligns with target belt path zone

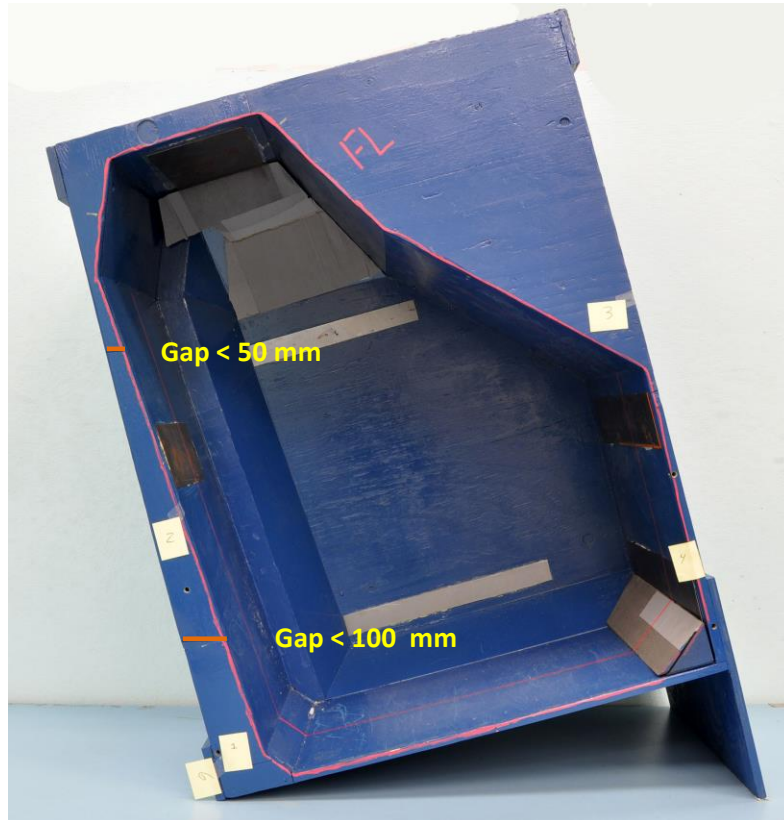

Figure 42. Locations for assessing gaps with FF CRS.

Results are summarized in Table 15, while photos are included in Appendix C. If a cell contains a number, that is the amount (in cm) that the CRS overhangs the edge of the envelope. Reasons why CRS did not fit were too big to fit in envelope, insufficient bottom contact (IBC), a lower gap greater than 100 mm (LG>100), or an upper gap greater than 50 mm (UG>50).

Table 15. Evaluation of FF CRS in envelopes.

Brand	Model	FS	FM	FL
Eddie Bauer	Summit, R1 (min)	Too Big	15.5	15.5
	Summit, R3 (max)	Too Big	Too Big	Too Big
Britax	Frontier 85, R1 (min)	IBC	2	2
	Frontier 85, R2 (max)	Too big	Too Big	LG>100
Orbit Baby	Toddler Car Seat	Too big	Too big	3
Sunshine Kids	Radian 80SL	LG> 100	UG>50	v
Compass	True Fit	Too big	v	v
Britax	Boulevard CS, R1 (min)	Too big	Too big	LG>100
	Boulevard CS, R2 (max)	Too big	Too big	IBC
Evenflo	Triumph Advance, R1 (min)	Too big	LG>100	LG>100
	Triumph Advance, R2 (max)	Too big	LG>100	LG>100
Evenflo	Symphony, R1 (min)	Too big	5.5	4.5
	Symphony, R3 (max)	Too big	IBC	v
Graco	Comfort Sport	Too big	4	4
Safety 1st	Alpha Omega Elite, R1 (min)	IBC	6.5	5.5
	Alpha Omega Elite, R2 (max)	Too big	IBC	LG>100
Eddie Bauer	Deluxe 3-in-1, R1 (min)	Too big	7.5	6
	Deluxe 3-in-1, R2 (max)	Too big	IBC	LG>100
Safety 1st	Scenera	1.25	1.25	1.25
Maxi-Cosi	Rodi Fix, R1 (min)	LG> 100	v	v
	Rodi Fix, R4 (max)	Too big	Too big	LG>100, UPUG UG>50
Baby Trend	Trendz FastBack 3-in-1	Belt path	Belt path	Belt path
Graco	Argos 70, R1 (min)	5.5	5.5	5
	Argos 70, R3 (max)	Too big	Too big	IBC
Maxi-Cosi	Pria, R1 (min)	IBC	Belt path	Belt path
	Pria, R2 (max)	Too big	IBC	LG>100
Safety 1st	Guide 65 Sport	Too big	Too big	v
Evenflo	Tribute LX	4	4	4
Graco	My Ride 65	Too big	Too big	v
Recaro	ProRIDE	Too big	Too big	LG>100
The First Years	True Fit SI	Too big	Too big	LG>100

Two FF CRS fit in the FS envelope and three others fit in the FM envelope. Four more CRS fit in the FL envelope. Eleven CRS did not fit into any envelopes under all configurations. One CRS (equipped with rigid LATCH) fit in the envelopes but its belt path did not overlap with the targeted corridors.

Vehicle Assessments

Results from assessing vehicle rear seats are shown in Table 16 for the RF envelopes and Table 17 for the FF envelopes. Photos of the installed envelopes are located in Appendix D. Key criteria for assessing fit were:

- Front seat placed at mid track position with a seat back angle of 23 degrees.
- Envelope base could be installed in vehicle and move less than 25 mm when a 40 lb lateral force is applied at the point where the flexible LATCH belt is attached.
- Envelope tips less than 5 degrees from vertical.
- Has no interference with front seat.
- Has no interference with lateral components (and rear door can be closed.)
- For RF_{veh}, bottom of envelope must be 10-20 degrees from horizontal about the lateral vehicle axis.
- For FF_{veh}, gap of less than 50 mm at top edge of base module.

All vehicles evaluated could fit the RS and FS envelopes in the rear seat. All but the Chevrolet Cruze could fit the RM and FM envelopes. For the RL_{veh} envelope, only the Ford F150, Subaru Outback and Toyota Sienna could accommodate it. All of the other vehicles had interference with the front seat, while the Hyundai Elantra also had interference with the B-pillar. For FL, all vehicles could accommodate it except for the Cruze and the Ford Focus.

Table 16. Vehicle assessments with RF_{veh} envelopes

Front seat at mid track, seat back at 23 degrees			
	RS	RM	RL
Chevrolet Cruze	√	FSI	FSI/LCI
Ford Escape	√	√	FSI
Ford F150	√	√	√
Honda Pilot	√	√	FSI
Hyundai Elantra	√	√	FSI, LCI
Nissan Sentra	√	√	FSI
Subaru Outback	√	√	√
Toyota Camry	√	√	FSI
Toyota Sienna	√	√	√

FSI: front seat interference LCI: lateral component interference

Table 17. Vehicle assessments with FF_{veh} envelopes

Front seat at mid track, seat back at 23 degrees			
Vehicle	FS	FM	FL
Chevrolet Cruze	√	LCI	LCI
Ford Escape	√	√	√
Ford F150	√	√	√
Ford Focus	√	√	LCI
Honda Accord	√	√	√
Hyundai Elantra	√	√	√
Nissan Sentra	√	√	√
Subaru Outback	√	√	√
Toyota Sienna	√	√	√

FSI: front seat interference LCI: lateral component interference

DISCUSSION

Approach

In Europe, child restraint fit envelopes are used to check that vehicle rear seats can accommodate particular volumes representing small, medium, and large RF and FF child restraints. The same envelope dimensions are used to check the sizes of child restraints. Information is provided to consumers regarding the size their child restraint fits in and the size their vehicle accommodates so they can choose products with greater likelihood of installation compatibility.

The same approach was adopted with consideration for the U.S. market. Child restraints meeting requirements of the latest February 2014 FMVSS No. 213 requirements were selected and measured to provide a range of child restraint sizes, types, and manufacturers. Their position in ten late model U.S. vehicles was recorded. These data were used to design fit envelopes representing the space occupied by small, medium, and large rear-facing and forward-facing child restraints that can be used as tools for promoting compatibility between vehicles and child restraints.

When envelopes were designed, the installed position of the CRS was considered. As described in more detail in a companion paper to this report (Klinich et al., 2015), the orientation of different CRS can vary substantially across vehicles. The design of the RF envelopes only included products that could be installed at an acceptable angle. The design of the FF envelopes did not include products that had an excessive gap between the seat back and CRS.

Once the installed position of the CRS was considered, the U.S. CRS did not fit within the ISO envelopes that were evaluated relative to the U.S. market in a previous study (Hu, Manary, Klinich, & Reed, 2015). It is not sufficient to align the base of the child restraint with the base of the envelopes, because the CRS might need to be shifted to be in a position that is at an angle acceptable for use.

Instead, new envelopes were designed that included efforts to harmonize dimensions between the United States and ISO envelopes. The RS, RM, and FS envelopes share most of the side profile dimensions with the ISO R1, R3, and F3 envelopes. However, the RS and FS envelopes are about 1.5 cm wider, while the RM envelope is about 4 cm wider. All of the ISO envelopes have the same lateral width, while the RS and FS U.S. envelopes have narrower widths than the larger sizes. Many of the FF CRS still were too wide relative to the final design of the FL envelope.

Industry Feedback

Feedback from vehicle and child restraint manufacturers was incorporated into the designs to minimize potential interference with curtain airbag housings. This involved slightly modifying the geometry of the top of the FM and FL envelopes. This change did not cause any FF CRS that previously met fit criteria to now fail. In addition, the suggestions from manufacturers to limit the fore-aft base of the envelope dimension were included to avoid the need for longer rear seat cushion. Only one product with an unusually deep base component was judged to no longer fit after the revision.

One manufacturer suggested a slight revision to the position of the front seat for testing to harmonize procedures with those used in Europe. When the ISO envelopes are assessed, the front seat is placed at the midpoint between the highest rearmost position and the lowest forward position as illustrated in Figure 43. Another manufacturer suggested using the UMTRI seating procedure to set the front seat location for a midsized male to provide more realistic conditions.

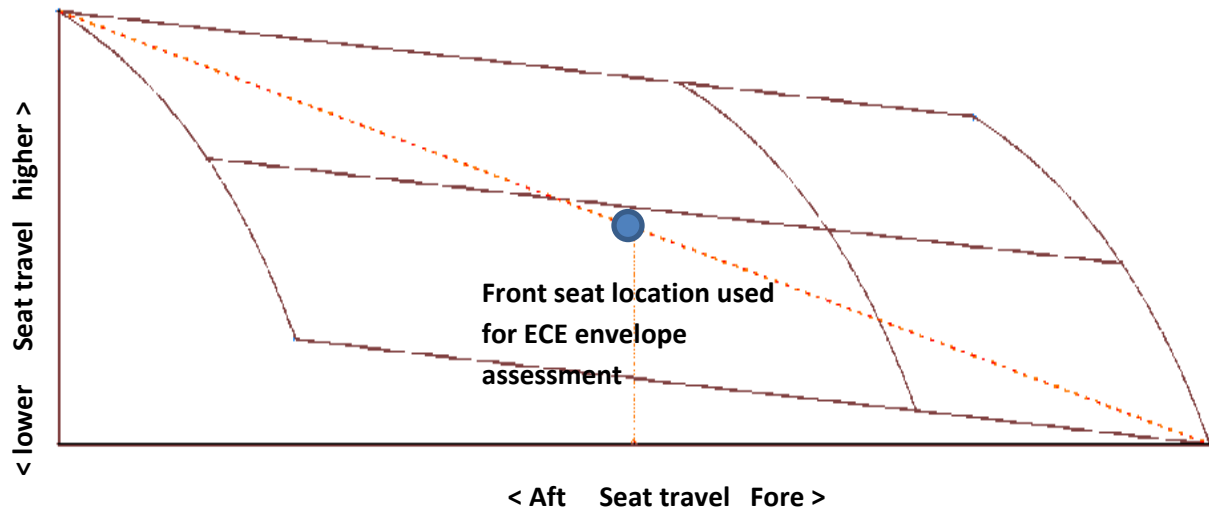

Figure 43. Location of front seat used in ECE assessment of envelope fit.

Limitations

One of the limitations of this analysis is that it did not assess the entire range of available child restraints and vehicles. However, the child restraints were selected to provide a range of manufacturers and dimensions. Vehicles selected are commonly used by families, and provided a range of seat characteristics.

Another limitation of this process is that if we had measured a product already, we assumed that the same mold was used to manufacture the current version of a product with the same name (Britax Frontier and Orbit Baby Toddler Seat). This may not be the case.

Use of the fit envelopes to characterize the size of CRS and the space available in vehicles may be complicated by multiple configurations possible with each child restraint. For example, a RF CRS might fit in the RM envelope with the lowest head restraint position and the infant recline angle but in the RL with the highest head restraint position at the toddler angle. A vehicle that can fit an RM-sized CRS might be able to use the CRS in its infant configuration but not the toddler configuration.

REFERENCES

- 76 FR 10637. Request for Comments, Federal Register, February 25, 2011. Consumer Information: Program for Child Restraint Systems, 10637–10664.
- Decina, L. E., & Lococo, K. H. (2005). Child restraint system use and misuse in six States. *Accident Analysis and Prevention*, 37:583-590.
- Decina, L. E., & Lococo, K. H. (2007). Observed LATCH use and misuse characteristics of child restraint systems in seven States. *Journal of Safety Research*, 38:271-281.
- Dukehart, J. G., Walker, L., Lococo, K., Decina, L. E., Staplin, L. (2007, February). *Safe Kids checkup events: A national study*. Washington DC: SafeKids Worldwide. Available at www.safekids.org/sites/default/files/documents/ResearchReports/Safe%20Kids%20Checkup%20Events%20A%20National%20Study%20-%20February%202007.pdf
- Greenwell, N. K. (2015, May). Results of the National Child Restraint Use Special Study (Report No. DOT HS 812 142). Washington, DC: National Highway Traffic Safety Administration. Available at <https://crashstats.nhtsa.dot.gov/Api/Public/ViewPublication/812142>
- Hu, J., Manary, M. A., Klinich, K. D., & Reed, M. P. (2015). Evaluation of ISO CRS envelopes relative to U.S. vehicles and child restraint systems. *Traffic Injury Prevention*, 16:8,781-785, DOI: 10.1080/15389588.2015.1014550
- International Organization for Standardization. (2006). *Road Vehicles—Anchorages in Vehicles and Attachments to Anchorages for Child Restraint Systems—Part 3: Classification of Child Restraint Dimensions and Space in Vehicle* (ISO 13216-3:2006(E). Geneva, Switzerland: Author.
- International Organization for Standardization. (2015). Working Draft revision of *Road Vehicles—Anchorages in Vehicles and Attachments to Anchorages for Child Restraint Systems—Part 3: Classification of Child Restraint Dimensions and Space in Vehicle* (ISO 13216-3). Geneva, Switzerland: Author.
- Jermakian, J. S., Klinich, K. D., Orton, N. R., Flannagan, C. A. C., Manary, M. A., Malik, L. M., & Narayanaswamy, P. (2014). Factors affecting tether use and correct use in child restraint installations. *Journal of Safety Research*, 51:99-108.
- Klinich, K. D., Boyle K, Malik L, Manary M, Hu J. (2015). Installed Positions of Child Restraint Systems in Vehicle Second Rows (Paper No. SAE-2015-01-1452). *SAE 2015 World Congress*, Detroit, April 21-23, 2015.
- Klinich, K. D., Flannagan, C. A. C., Jermakian, J. S., McCartt, A. T., Manary, M. A., Moore, J. L., & Wells J. K. (2013) Vehicle LATCH system features associated with correct child restraint installations. *Traffic Injury Prevention* 14(5):520-31 doi:
- Klinich, K. D., Manary, M. A., Flannagan, C. A., Ebert, S. M., Malik, L. A., Green, P. A., & Reed, M. P. (2013). Effects of child restraint features on installation errors. *Applied Ergonomics*, May 31. doi:pii: S0003-6870(13)00077-X. 10.1016/j.apergo.2013.04.005.
- Klinich, K. D., Manary, M. A., Flannagan, C. A. C., Malik, L. A., & Reed, M. P. (2012, July). *Effects of vehicle features on CRS installation errors* (Report No. DOT HS 811 626), Washington, DC: National Highway Traffic Safety Administration. Available at www.nhtsa.gov/sites/nhtsa.dot.gov/files/811626.pdf
- Koppel, S., & Charlton, J. L. (2009). Child restraint system misuse and/or inappropriate use in Australia. *Traffic Injury Prevention*, 10:302-307.

- Mirman, J. H., Curry, A. E., Zonfrillo, M. R., Corregano, L. M., Seifert, S., & Arbogast, K. B. (2014) Caregivers' confidence in performing child safety seat installations: what matters most? *Injury Prevention, 20*(3):167-71.
- National Child Passenger Safety Board. (2014). *National Child Passenger Safety Certification Training Program*. (Web page). Copyrighted by the author and co-published with the National Safety Council under contract with the National Highway Traffic Safety Administration, Washington, DC. Available at <http://cpsboard.org/tech-instructor-curriculum>
- Tsai, Y.-F. D., & Perel, M. (2009). *Driver's mistakes when installing child seats* (Report No. DOT HS 811 234). Washington DC: National Highway Traffic Safety Administration. Available at <https://one.nhtsa.gov/DOT/NHTSA/NVS/Crash%20Avoidance/Technical%20Publications/2009/811234.pdf>

APPENDIX A:
Photos of Physical Envelopes

RF_{CRS}

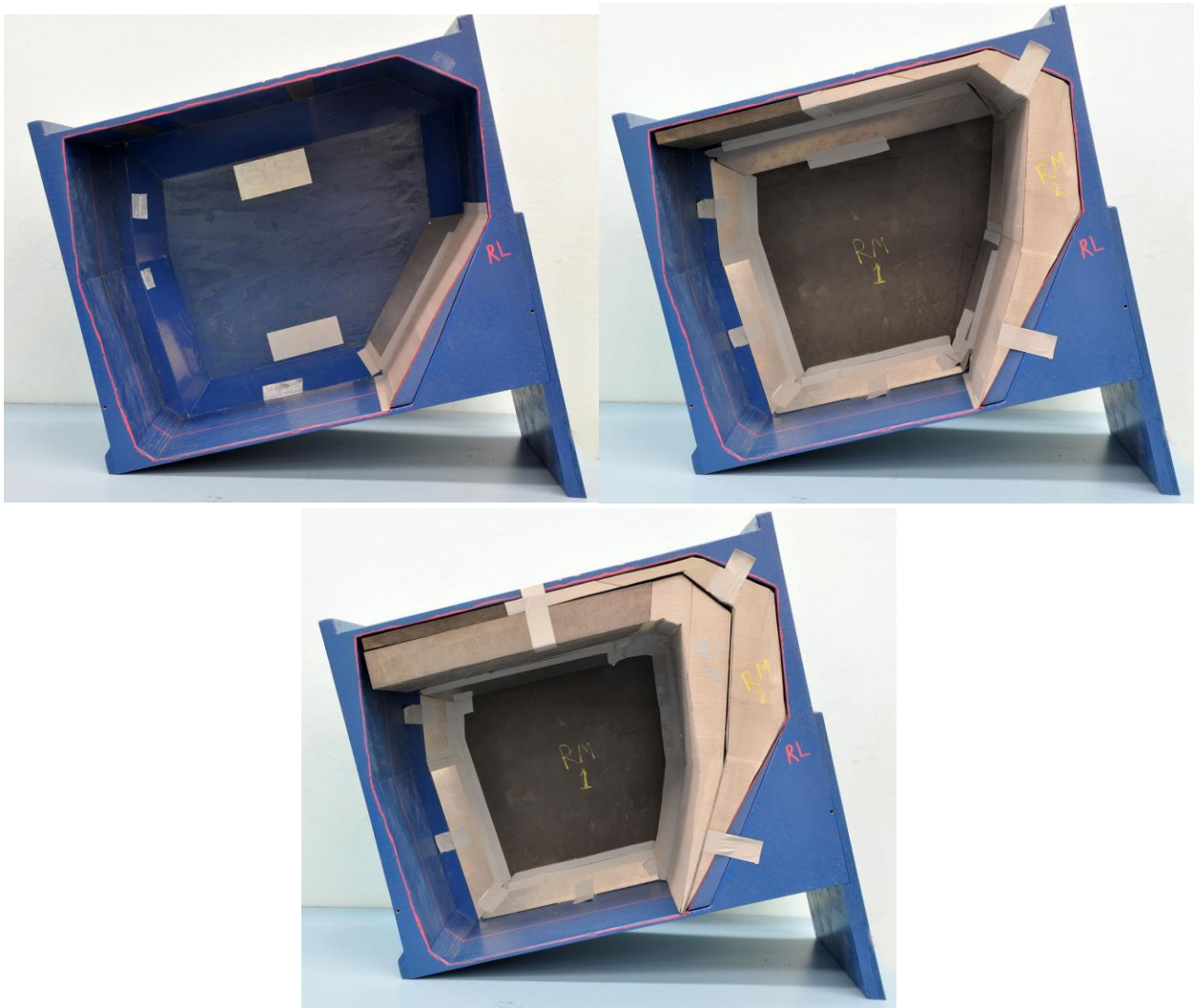

Figure 1. RF_{CRS} envelope RL (left top), RM (right top), and RS (bottom).



Figure 2. Inserts used to convert RL to RM.



Figure 3. Insert used to convert RM to RS.

RF_{veh}



Figure 4. RF_{veh} envelope RL (left top), RM (right top), and RS (bottom).

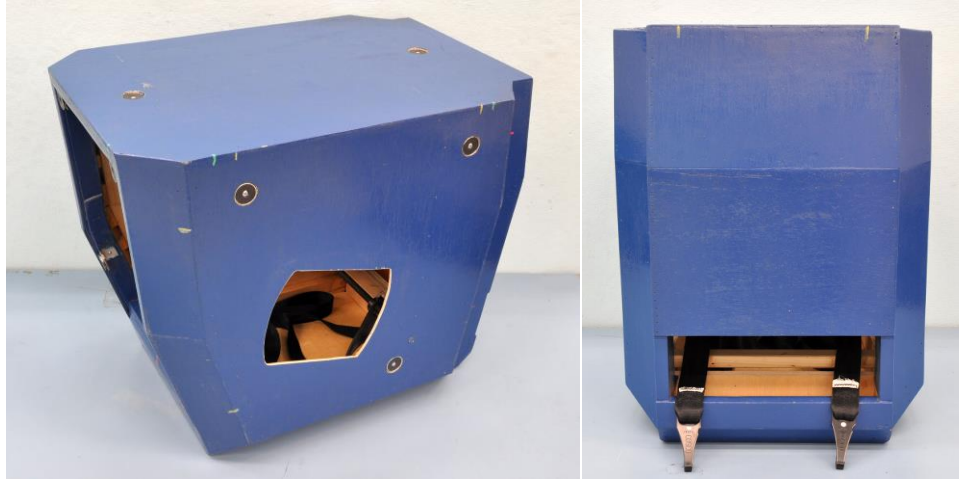

Figure 5. Base of RF_{veh} , installed with flexible LATCH belts (right)



Figure 6. Component added to top of base to make RS_{veh} (left); components added to front and top of RS_{veh} to make RM_{veh} (right).



Figure 7. Components added to sides (left and middle) and top of RM_{veh} to make RL_{veh} .

FF_{CRS}

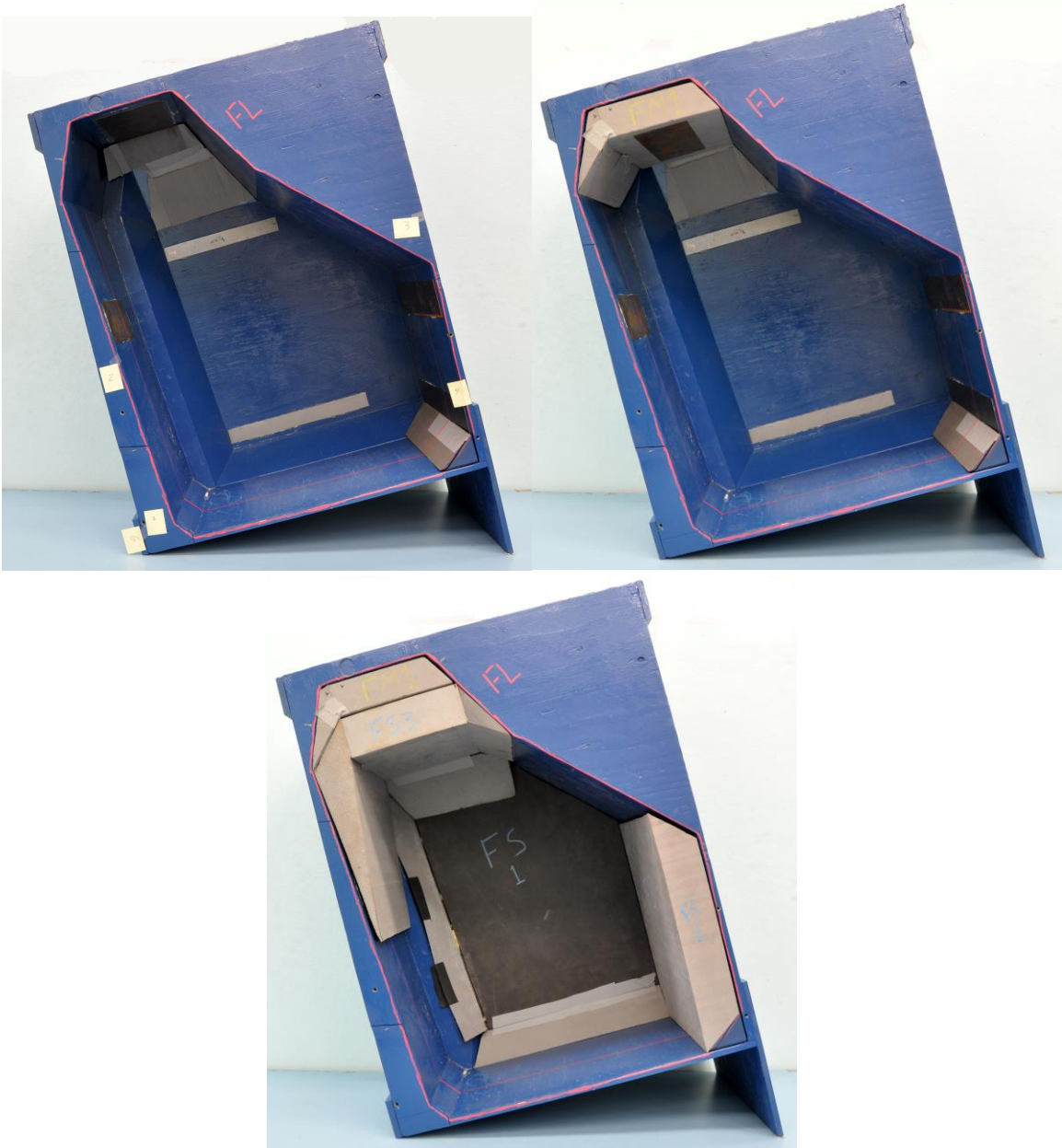

Figure 8. FF_{CRS} envelope FL (left top), FM (right top), and FS (bottom).



Figure 9. Component added to FL to make FM.

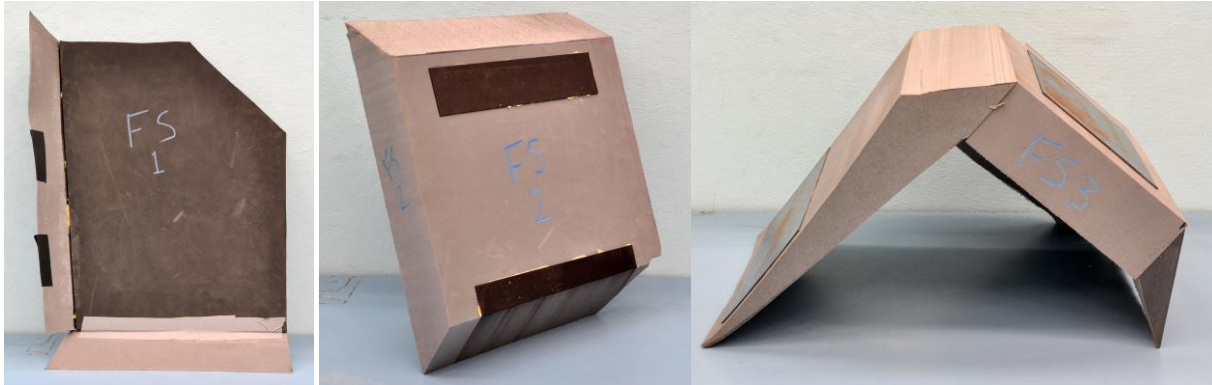

Figure 10. Components added to FM to make FL.

FF_{veh}

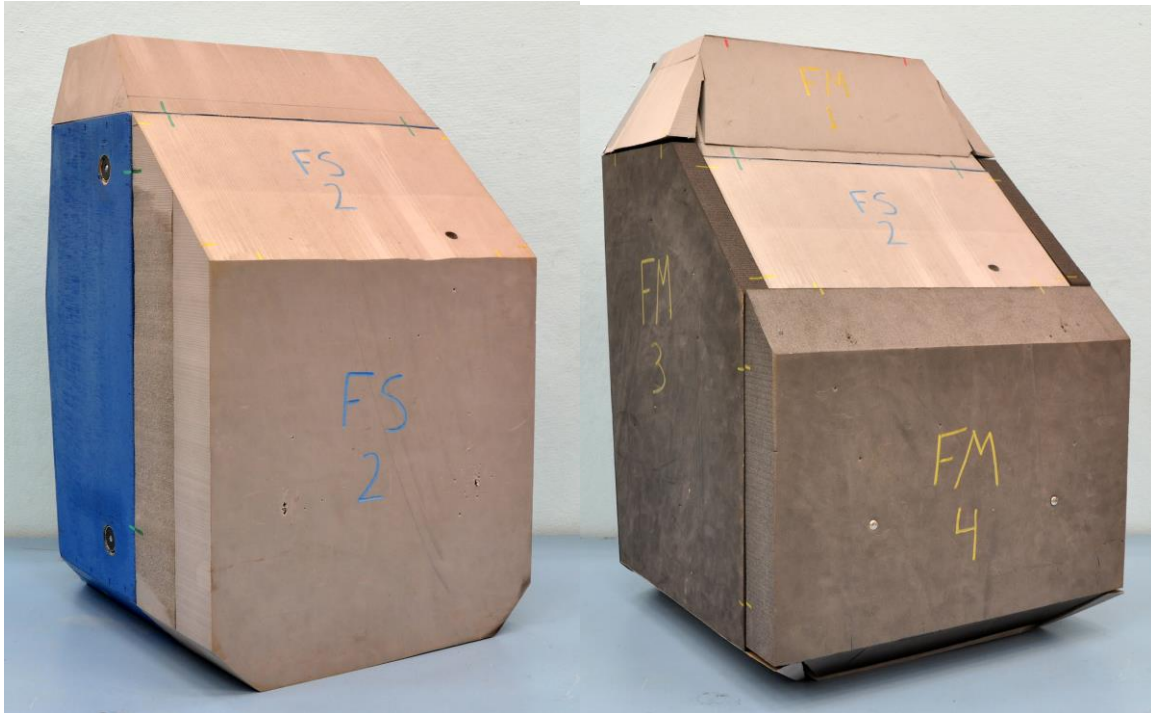

Figure 11. FF_{veh} envelope FS (left top), FM (right top), and FL (bottom).

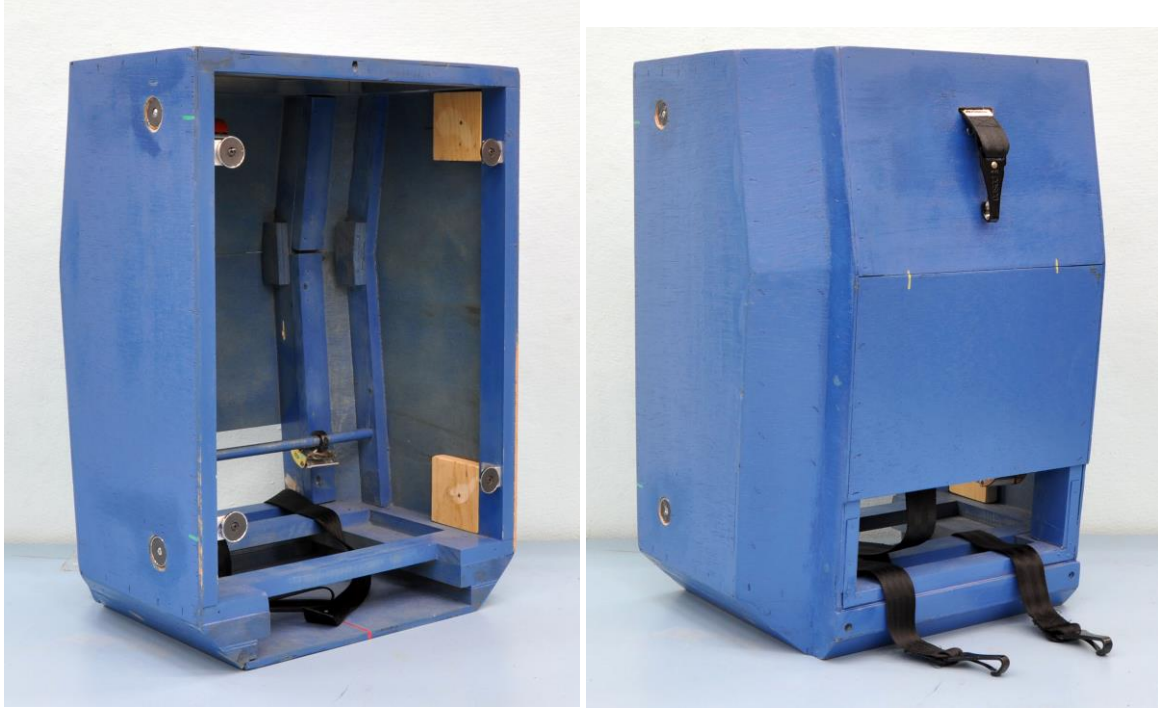

Figure 12. Base of RF_{veh} , installed with flexible LATCH belts (right)

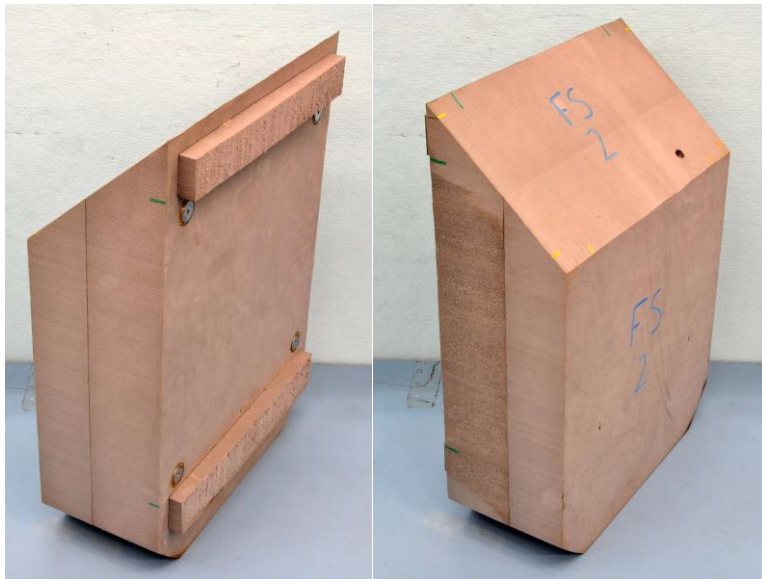

Figure 13. Components added to base to make FS_{veh} .



Figure 14. Components added to convert FS_{veh} to FM_{veh} .

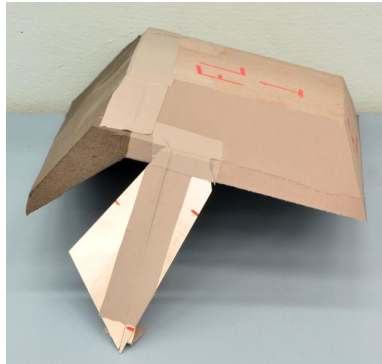

Figure 15. Component added to convert FM_{veh} to FL_{veh} .

APPENDIX B:
Envelope Testing Instructions

Vehicle: Forward-Facing

FS Envelope

1. Choose a vehicle seating position for envelope installation. For the seat in front of the test position, adjust the seat position to the mid-track fore-aft position. If the seat height can be adjusted, place it at the mid-height position.
2. Using H-Point machine measurements, adjust the back angle of the seat in front of the test position to 23 degrees or design seat back angle.
3. If the vehicle seat in the test position is adjustable, move the seat position to the mid-track fore-aft position. If there is no mid-track position, adjust to the closest setting behind mid-track. If the seat height can be adjusted, place it at the mid-height position.
4. Using the vehicle instructions, prepare the vehicle head restraint as specified for use with a child restraint. If specified by the vehicle manual, set the seat back angle to the position required for child restraint installation. If head restraint position and seat back angle are not specified in the vehicle manual, they can be adjusted to produce the best envelope fit within conditions allowed for travel.
5. Identify the centerline between the vehicle's lower anchors in the test seating position. Place a piece of tape along the LATCH lower anchor centerline of the seat.
6. Place the FO wood envelope base into the test position, initially centering between the LATCH lower anchors. The opening should face the front of the vehicle. Make sure the tether strap is not trapped between the envelope and vehicle seat.



7. Attach the LATCH belts on the envelope to the lower anchors of the test position.
8. Tighten the envelope into the vehicle seat, first pushing downward to maximize contact with the seat cushion, then moving rearward against the vehicle seat back.
9. Attach the top tether strap to the tether anchor in the vehicle using the tether routing specified in the vehicle manual.
10. Tighten the top tether.
11. Re-tighten the LATCH belts and top tether if needed.

12. Mark the lateral location of the box on the vehicle seat with a piece of tape. Apply a lateral horizontal force of 40 lbf to the side of the box at the marked position on the box. Measure how much the box moves relative to the tape. The envelope base should not move more than 25 mm laterally.
13. Attach piece FS1 to the front of the F0 base, using magnetic connectors and aligning reference marks.



14. Attach piece FS2 to the front of the base, using magnetic connectors and aligning reference marks.

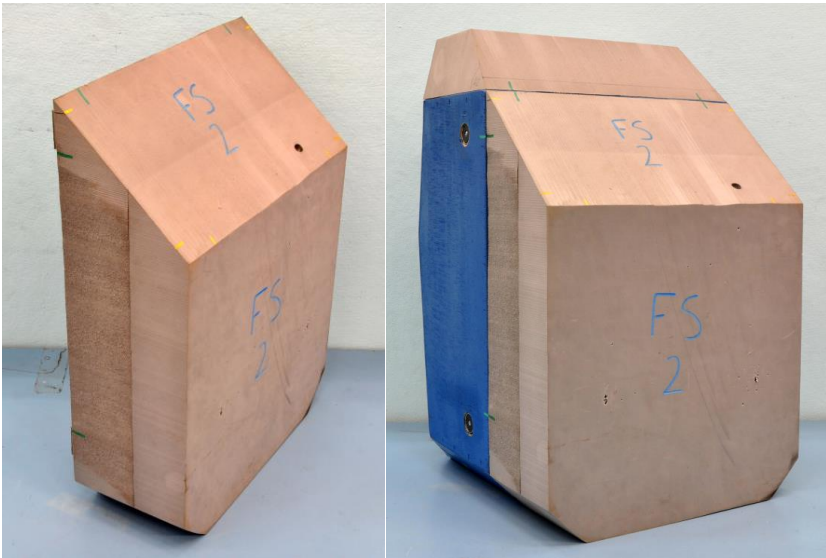

15. Check fit of the envelope in the test position:
 - a. Measure the lateral angle of the envelope on the outboard side of the envelope. Angles less than 5 degrees from vertical are recommended. Check that angle is acceptable with adjacent door shut.
 - b. Check for interference with forward vehicle seat, door frame, headliner, or head restraint.
16. Leave FS envelope components in vehicle in preparation for testing FM and FL.

FM Envelope

1. As done to assemble FS, attach foam pieces using magnetic connectors and aligning reference marks.
2. If needed, the forward seat can be shifted to provide more room for installation, but be sure to return it to the correct fore-aft position and angle after the envelope is assembled.
3. Attach piece FM1 to the top of the FS envelope. If needed, the FS envelope can be loosened and tipped to allow installation of FM1, which includes a slot that can be shifted to fit around the attached tether. In some vehicles it may be easier to remove piece FS1, attach FM1, and install both of them to the base simultaneously.



4. If needed, retighten the F0 base, check that it still meets tightness requirement, and reattach piece FS2.
5. Attach piece FM2 to the left side and FM3 to the right side of FS.



6. Using alignment pins and holes, attach piece FM4 to the front of FS.

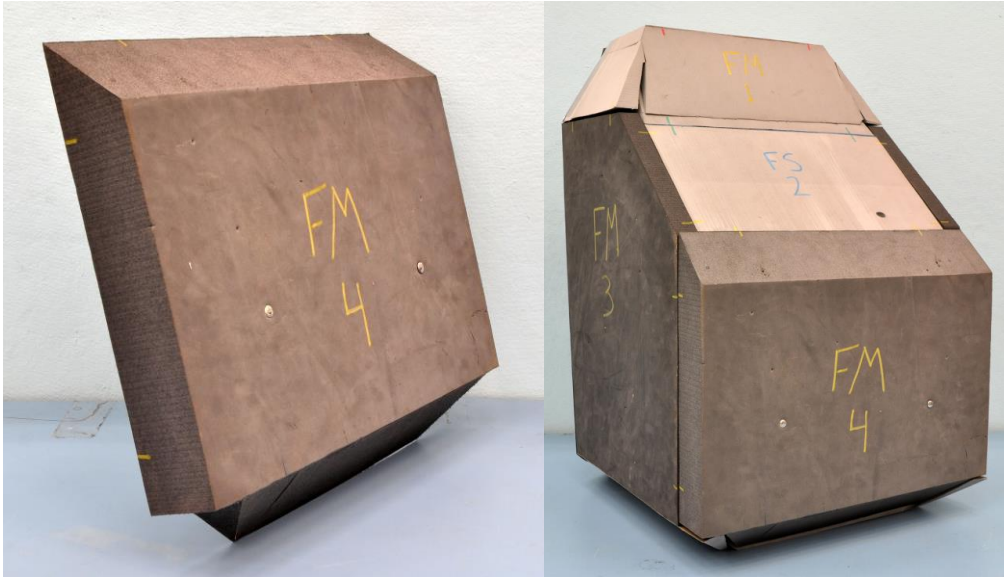

7. Check fit of the envelope in the test position:
 - a. Measure the lateral angle of the envelope on the outboard side of the envelope. Angles less than 5 degrees from vertical are recommended. Check that angle is acceptable with adjacent door shut.
 - b. At a point 10 cm below the top of the vehicle seat back, measure the gap between the vehicle seat back and envelope. Gaps less than 50 mm are recommended.
 - c. Check for interference with forward vehicle seat, door frame, headliner, or head restraint.
8. Leave FM envelope components in vehicle in preparation for testing FL.

FF Envelope

1. As done to assemble FS and FM, attach foam pieces using magnetic connectors and aligning reference marks.
2. If needed, the forward seat can be shifted to provide more room for installation, but be sure to return it to the correct fore-aft position and angle after the envelope is assembled.
3. Attach piece FL1 to the top of the FM envelope. If needed, the FM envelope can be loosened and tipped to allow installation of FL1.



4. If needed, retighten the F0 base and reattach pieces FS2 and FM4.
5. Check fit of the envelope in the test position:
 - a. Measure the lateral angle of the envelope on the outboard side of the envelope. Angles less than 5 degrees from vertical are recommended. Check that angle is acceptable with adjacent door shut.
 - b. At a point 10 cm below the top of the vehicle seat, measure the gap between the vehicle seat back and envelope. Gaps less than 50 mm are recommended.
 - c. Check for interference with forward vehicle seat, door frame, headliner, or head restraint.

Vehicle: Rear-Facing

RS Envelope

1. Choose a vehicle seating position for envelope installation. For the seat in front of the test position, adjust the seat position to the mid-track fore-aft position. If the seat height can be adjusted, place it in the mid-height position.
2. Using H-Point machine measurements, adjust the back angle of the seat in front of the test position to 23 degrees or design seat back angle.
3. If the test seat position is adjustable, move the seat position to the mid-track fore-aft position. If there is no mid-track position, adjust to the closest setting behind mid-track. If the seat height can be adjusted, place it in the mid-height position.
4. Using the vehicle instructions, prepare the vehicle head restraint as specified for use with a child restraint. If specified by the vehicle manual, set the seat back angle to the position required for child restraint installation. If head restraint position and seat back angle are not specified in the vehicle manual, they can be adjusted to produce the best envelope fit within conditions allowed for travel.
5. Identify the centerline between the LATCH lower anchors in the test position. Place a piece of tape along the lower anchor centerline of the test position.
6. If needed, the forward seat can be shifted to provide more room for installation, but be sure to return it to the correct fore-aft position and angle after the envelope is assembled.
7. Place the R0 wood envelope base into the test position, initially centering between the lower anchors. The opening should face the front of the vehicle.

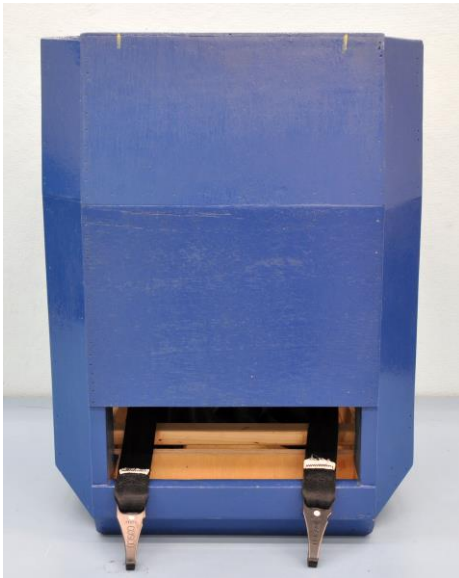

8. Attach the LATCH belt on the envelope to the lower anchors of the test position.
9. Tighten the envelope into the vehicle seat, first pushing downward to maximize contact with the seat cushion, then moving rearward against the vehicle seat back. Straps can be accessed through the holes in the sides.
10. Mark the lateral location of the box on the vehicle seat with a piece of tape. Apply a lateral horizontal force of 40 lbf to the side of the box at the marked position on the box. Measure how

much the box moves relative to the tape. The envelope base should not move more than 25 mm laterally.

11. Attach piece RS1 to the top of the R0 base, using magnetic connectors and aligning reference marks.



12. Check fit of the envelope in the test position:
 - a. Measure the lateral angle of the envelope on the outboard side of the envelope. Angles less than 5 degrees from vertical are recommended. Check that angle is acceptable with adjacent door shut.
 - b. Measure the angle of the top of the RS envelope. The angle should range from 10 to 20 degrees.
 - c. Check for interference with door frame, headliner, B-pillar, or head restraint.
 - d. When checking for interference with forward vehicle seat, use requirements specified in the vehicle manual. If manual specifies that a CRS cannot touch the forward seat, the gap should measure at least 1 cm.
13. Remove RS1 foam piece, but leave the R0 base in place for testing with RM and RL.

RM Envelope

1. As done to assemble RS, attach foam pieces using magnetic connectors and aligning reference marks.
2. If needed, the forward seat can be shifted to provide more room for installation, but be sure to return it to the correct fore-aft position and angle after the envelope is assembled.
3. Attach piece RM1 to the top of R0.



4. Attach piece RM2 to the front of R0.



5. Check fit of the envelope in the test position.
 - a. Measure the lateral angle of the envelope on the outboard side of the envelope. Angles less than 5 degrees from vertical are recommended. Check that angle is acceptable with adjacent door shut.
 - b. Measure the angle of the top of the RS envelope. The angle should range from 10 to 20 degrees.
 - c. Check for interference with door frame, headliner, B-pillar, or head restraint.
 - d. When checking for interference with forward vehicle seat, use requirements specified in vehicle manual. If manual specifies that a CRS cannot touch the forward seat, the gap should measure at least 1 cm.
6. Leave RM envelope in place in preparation for testing with RL.

RL Envelope

1. As done to assemble RS and RM, attach foam pieces using magnetic connectors and aligning reference marks.
2. If needed, the forward seat can be shifted to provide more room for installation, but be sure to return it to the correct fore-aft position and angle after the envelope is assembled.
3. Attach RL1 to the top of RM. In some vehicles, it is easier to place while approaching from the inboard side of the vehicle.

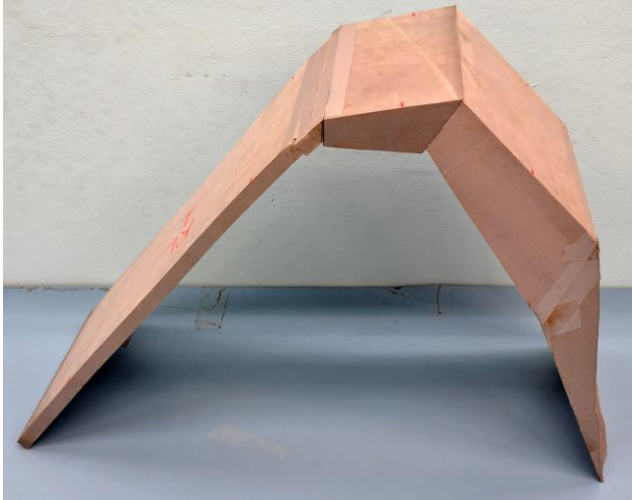

4. Attach RL2 to the left side of RM. Attach RL3 to the right side of RM. Use tape to secure the hanging sheet metal components so the edges meet with the front of RL.



5. Check fit of the envelope in the test position.
 - a. Measure the lateral angle of the envelope on the outboard side of the envelope. Angles less than 5 degrees from vertical are recommended. Check that angle is acceptable with adjacent door shut.
 - b. Measure the angle of the top of the RS envelope. The angle should range from 10 to 20 degrees.
 - c. Check for interference with door frame, headliner, B-pillar, or head restraint.
 - d. When checking for interference with forward vehicle seat, use requirements specified in vehicle manual. If manual specifies that a CRS cannot touch the forward seat, the gap should measure at least 1 cm.

Vehicle Virtual Fitting Instructions

1. Set up the virtual vehicle following the same directions used for the physical evaluation.
2. Align the envelope laterally with the centerline of the lower anchors.
3. Rotate the envelope so the bottom is parallel to the vehicle seat cushion.
4. Translate the envelope so the bottom surface of the envelope overlaps the seat cushion centerline by 1 cm or the seat cushion bolsters by 2 cm.
5. Translate the envelope so the rear surface of the envelope overlaps the seat back or head restraint centerline by 1 cm or the seat back bolsters by 2 cm.
6. Check fit
 - a. For FM and FL envelopes, check that gap between envelope and seat back at a point 10 cm below top of the seat back is less than 50 mm.
 - b. For RF envelope, check that bottom surface of envelope is at an angle of 10 to 20 degrees above horizontal.
 - c. For all envelopes, check that the envelope is not tipped laterally more than 5 degrees from vertical.
 - d. Check for interference with door frame, headliner, B-pillar, or head restraint.
 - e. When checking for interference with forward vehicle seat, use requirements specified in vehicle manual. If manual specifies that a CRS cannot touch the forward seat, the gap should measure at least 1 cm.

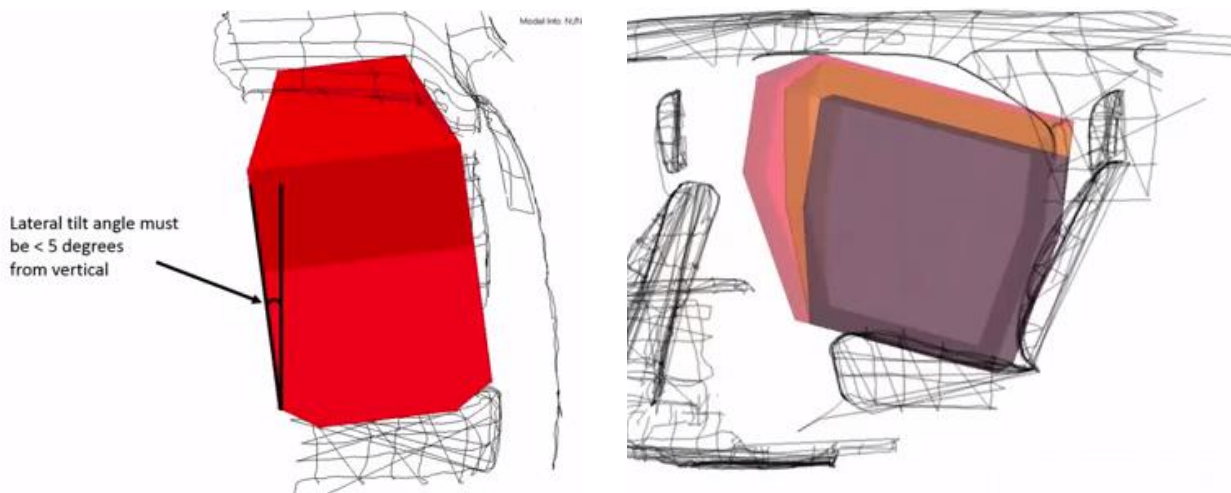

Child Restraints: Rear-Facing Envelope

1. Set up the envelope.
 - a. Place the RL envelope on a flat, level surface.

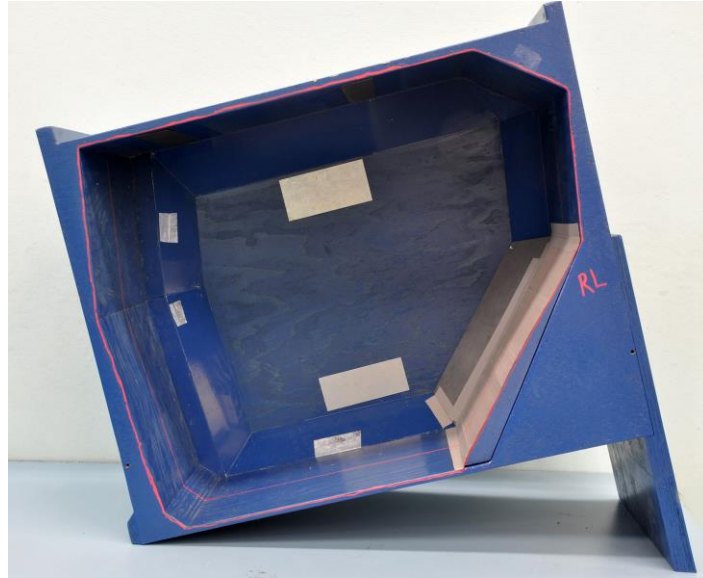

- b. To test with RM, insert piece RM1 into the RL envelope. Then insert piece RM2. The inserts attach with magnetic connectors.

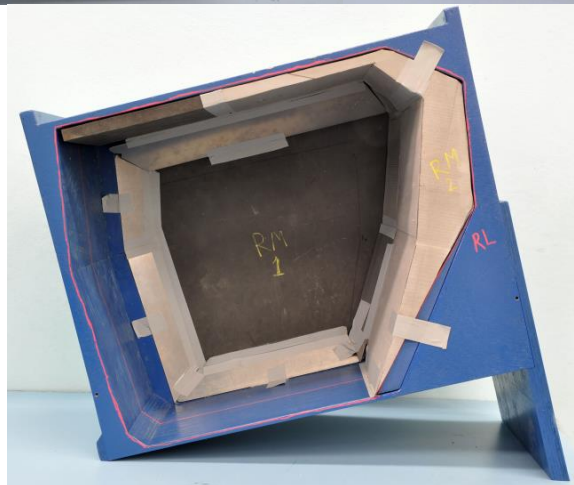

- c. To test with RS, insert piece RS1 into the RM envelope, attaching with magnetic connectors.

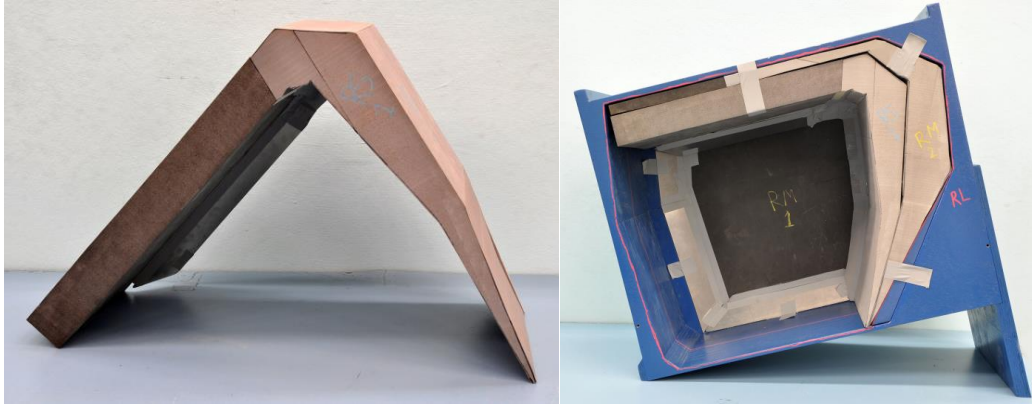

2. Set up the child restraint.

- a. If there are multiple recline angles and/or head restraint heights, the CRS must fit within the envelope using all combinations that are allowed for rear-facing use. The RF CRS below has the recline angle set to the rear-facing position.



- b. If the child restraint has an adjustable base, adjust the recline angle to achieve an acceptable installed angle.



-Place the child restraint in the envelope.

- a. Position the CRS in the envelope so that the bottom surface (footprint) contacts the bottom of the envelope as much as possible and its centerline is parallel to the opening.
 - b. Slide the CRS rearward until it contacts the seat back portion of the envelope, while maintaining the centerline parallel to the opening of the envelope.
3. Check fit.
- a. Make sure the child restraint contacts the bottom of the envelope. All bottom surfaces should be below the point indicated by the green arrow.



Unacceptable contact



Acceptable contact

- b. The bottom structure of the child restraint (footprint) must fit inside the envelope in all configurations to meet the fit requirements. The upper parts of the CRS can extend laterally beyond the envelope, but the footprint intended to contact the vehicle seat cushion must fit within the bottom of the envelope. Another way to check fit is that the centerline of the child restraint should align with the centerline of the envelope.



Good fit

Bottom too wide

- c. Check the level indicator on the child restraint to ensure it is within the acceptable angle range for that seat. For line indicators, the acceptable range is $\pm 5^\circ$ from horizontal.

- d. Affix the belt path jig to the front of the envelope. Part of the CRS belt path should fall within the outlined shape on the jig (see below).

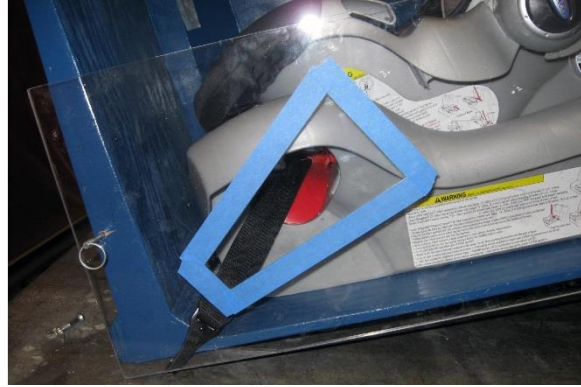

Child Restraint: Forward-Facing Envelope

1. Set up the envelope.
 - a. Place the FL envelope on a flat, level surface.

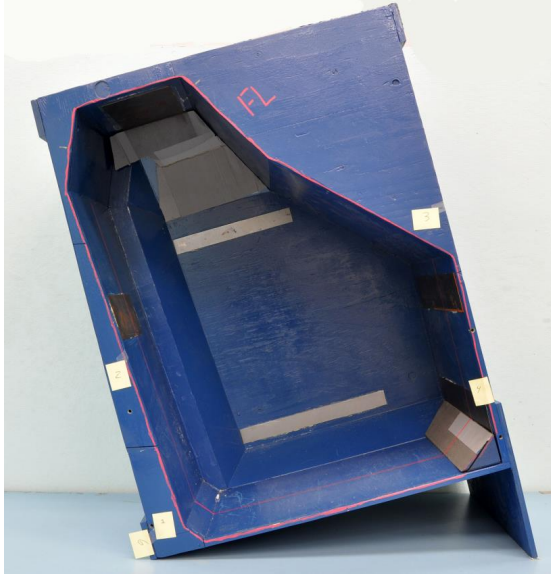

- b. To test with FM, insert piece FM1 into the FL envelope, attaching with magnetic connectors.

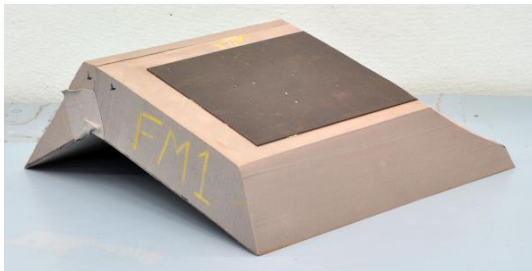

- c. To test with FS, insert piece FS1 into the back of the FM envelope, FS2 into the front, and FS3 into the top, attaching with magnetic connectors.

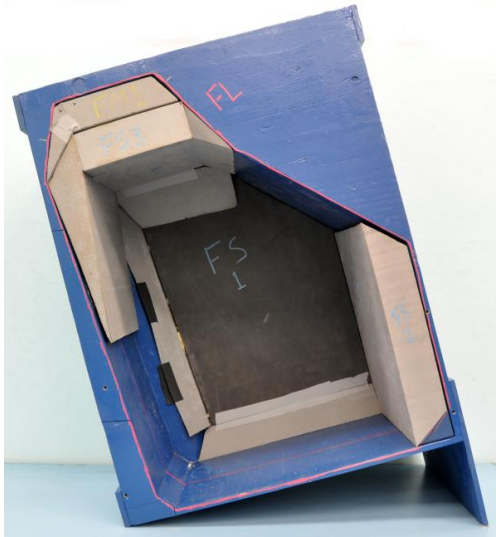
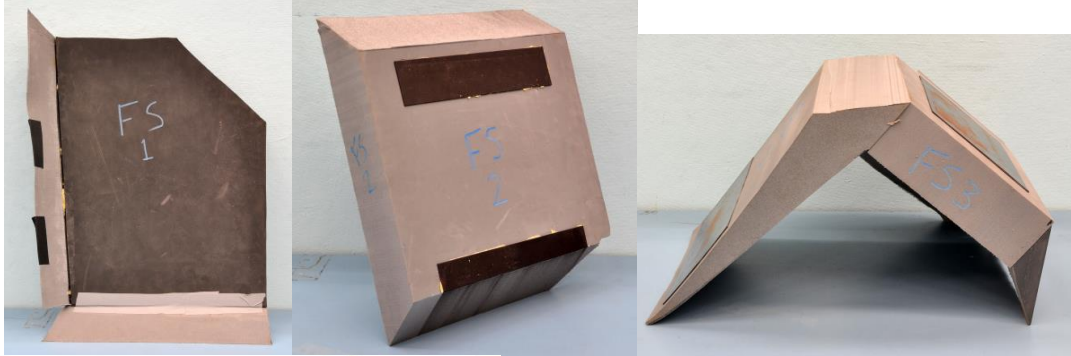

2. Set up the child restraint.
- a. The CRS should be evaluated at the lowest and highest head restraint position while choosing an angle acceptable for forward-facing use. Different angles can be used with each head restraint position. The CRS below is set to one of two allowable forward-facing recline positions.



3. Place the child restraint in the envelope.
 - a. Position the CRS in the envelope so that the bottom (footprint) contacts the bottom of the envelope as much as possible and its centerline is parallel to the opening.
 - b. Slide the CRS rearward until it contacts the seat back portion of the envelope, while maintaining the centerline parallel to the opening of the envelope.
4. Check fit.
 - a. Make sure the child restraint is contacting the bottom of the envelope. If the bottom of the child restraint (footprint) is not completely inside the envelope, measure the amount that sticks out (below). Ideally, the centerline of the child restraint should align with the centerline of the envelopes.



- b. Measure the gap from the back of the CRS to the edge of the envelope:
 - a. At the line marked on the envelope 10 cm down from the top of the rearmost flat edge (top arrow), a gap between the CRS and the envelope less than 50 mm is recommended.
 - b. At the line marked on the envelope 22 cm up from the tabletop (bottom arrow), a gap between the CRS and the envelope of less than 100 mm is recommended.

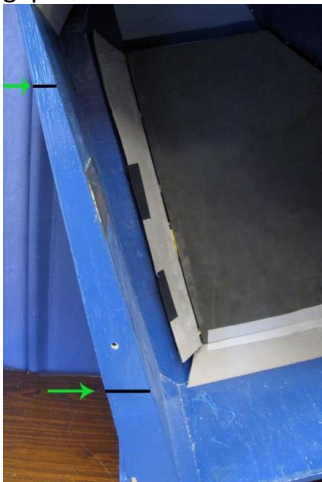

- c. Place the belt path jig to the front of the envelope. Part of the CRS belt path should fall within the outlined shape on the jig (below).







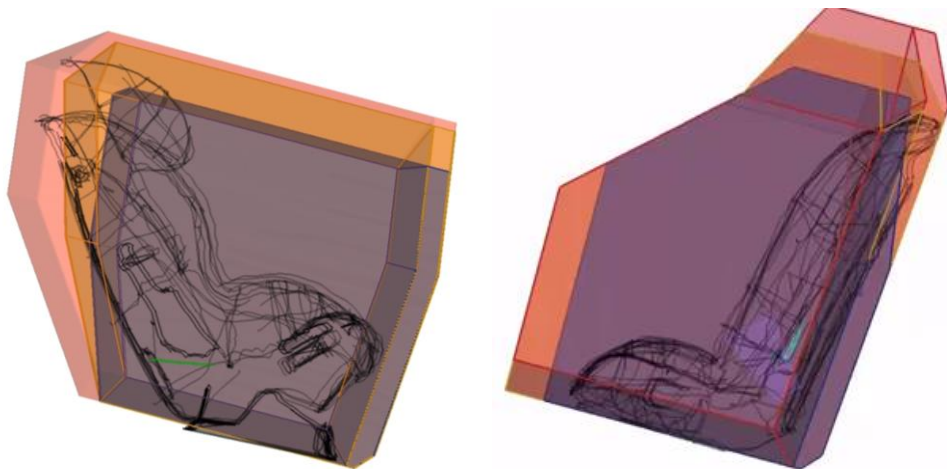

Child Restraint Virtual Fitting Instructions









1. Rotate the envelope so its bottom surface is positioned 15 degrees above horizontal.
2. Align CRS with envelope.
3. Rotate the CRS and then translate so its bottom surface contacts the bottom surface of the envelope.
4. Check fit
 - a. The CRS is positioned at an acceptable angle for use.
 - b. The bottom surface of the CRS contacts the bottom surface of the envelope.
 - c. Part of the belt path overlaps with the belt zone.
 - d. For the FM and FL envelopes, a gap at a point 10 cm below the top rear corner of the envelope is recommended to be less than 50 mm. A gap 18 cm above the bottom rear corner of the envelope is recommended to be less than 100 mm
 - e. In the long-term, the CRS shape should not extend past the envelope dimensions. In the near-term, some protrusion past the dimensions (perhaps 1 cm on primary surfaces and 2 cm on angled surfaces) may be allowed.
 - f. For RF CRS with an adjustable handle, at least one handle position allowed for transport must fit within the envelope.
 - g. For RF CRS, all combinations of angle and head restraint position allowed for rear-facing use should fit within the envelope.
 - h. For FF CRS, head restraint must be tested in highest and lowest positions, while choosing an angle acceptable for use (that can vary with each head restraint position). The CRS should fit in at least one angle with each head restraint position.









APPENDIX C:
CRS in Envelopes

RFCRS









CRS	RS	RM	RL
Baby Trend Flex-Loc no base	 <p>Fits</p>	Fits	Fits
Baby Trend Flex-Loc with base	Too big	 <p>Fits</p>	Fits
Britax B-SAFE No base	 <p>Could not achieve angle</p>	 <p>Fits</p>	 <p>Fits</p>
Britax B-SAFE With base	Too big	 <p>Fits</p>	 <p>Fits</p>

CRS	RS	RM	RL
Britax Boulevard CS	Too big	 <p>Too wide</p>	 <p>Too wide, insufficient bottom contact</p>
Chicco KeyFit no base	 <p>Unable to achieve angle</p>	Fits	Fits
Chicco KeyFit 30 no base	 <p>Unable to achieve angle</p>	 <p>Fits; does not meet belt path</p>	 <p>Fits; does not meet belt path</p>
Chicco KeyFit with base	Too big	 <p>Fits</p>	Fits
Chicco KeyFit 30 With base	Unable to achieve angle, insufficient bottom contact	 <p>Too wide</p>	 <p>Too wide</p>







CRS	RS	RM	RL
Compass True Fit (min)	 <p>Cannot achieve angle</p>	Angle	Insufficient bottom contact
Compass True Fit (max)	Too large	 <p>Cannot achieve angle</p>	 <p>Insufficient bottom contact</p>
Cosco Comfy Carry no base	 <p>Fits</p>	 <p>Fits</p>	Fits
Cosco Comfy Carry with base	Too big	 <p>Fits</p>	Fits

CRS	RS	RM	RL
Eddie Bauer Deluxe 3-in-1	Too big	Too big	 <p>Too wide, insufficient bottom contact</p>
Evenflo Nurture with base	Too big	 <p>Fits</p>	 <p>Fits</p>
Evenflo Nurture no base	 <p>Insufficient bottom contact</p>	 <p>Fits</p>	 <p>Fits</p>
Evenflo Tribute LX	 <p>Unable to achieve angle</p>	 <p>Unable to achieve angle</p>	 <p>Insufficient bottom contact</p>



CRS	RS	RM	RL
Evenflo Triumph Advance	Too Big	 <p data-bbox="717 548 1073 615">Too wide, unable to achieve angle</p>	Width
Evenflo Symphony (min)	Too big	 <p data-bbox="717 915 1073 982">Too wide, unable to achieve angle</p>	Fits
Evenflo Symphony (max)	Too big	Too big	 <p data-bbox="1091 1283 1446 1312">Fits</p>
Graco Comfort Sport	 <p data-bbox="344 1612 699 1680">Too big, insufficient bottom contact</p>	 <p data-bbox="717 1612 1073 1680">Unable to achieve angle</p>	 <p data-bbox="1091 1612 1446 1680">Unable to achieve angle</p>

CRS	RS	RM	RL
Graco SnugRide Classic Connect no base	 Fits	Fits	Fits
Graco SnugRide Classic Connect 35 no base	 Fits	 Fits	 Fits
Graco SnugRide Classic Connect with base	Too big	 Fits	Fits
Graco SnugRide Classic Connect 35 with base	Too big	 Fits	 Fits
Graco My Ride 65	Too big	 Fits	 Fits

CRS	RS	RM	RL
Maxi-Cosi Prezi with base (max)	Too big	 IBC	 Fits
Maxi-Cosi Mico With base	 Too big	Too big	 Fits
Maxi-Cosi Prezi no base (min)	 IBC	 Angle	 Fits
Maxi-Cosi Pria (min)	 Could not achieve correct angle	 Insufficient bottom contact	Fits







CRS	RS	RM	RL
Maxi-Cosi Mico No base	Too big	 Fits	 Fits
Maxi-Cosi Pria (max)	Too big	 Fits	Fits
Orbit Baby Toddler Car Seat	 Too big	Too Big	 Too wide
Peg Perego Primo Viaggio SIP no base	Too big	 Insufficient bottom contact	Insufficient bottom contact







CRS	RS	RM	RL
Peg Perego Primo Viaggio SIP with base	Too big	 Too wide	 Too wide
Recaro ProRide	Too wide	Too Wide	 Insufficient bottom contact
Safety 1st Guide 65 Sport min	 Fits	Fits	Fits
Safety 1st Guide 65 Sport max	 Fits	 Fits	 Fits
Safety 1st Scenera	Could not achieve correct angle	 Could not achieve correct angle	 Could not achieve correct angle









CRS	RS	RM	RL
Safety 1st Alpha Omega Elite	Too big	 <p data-bbox="717 520 1062 604">Unable to achieve angle</p>	 <p data-bbox="1088 520 1432 604">Insufficient bottom contact, too wide</p>
Sunshine Kids Radian 80SL	IBC	IBC	 <p data-bbox="1088 919 1432 991">Footprint doesn't contact base-IBC</p>







FF CRS

CRS	FS	FM	FL
Eddie Bauer Summit Min	Too Big	 <p>Overhang 15.5</p>	 <p>Overhang 15.5</p>
Eddie Bauer Summit Max	Too Big	Overhang 15.5	 <p>Overhang 15.5</p>
Britax Frontier 85 min	 <p>IBC</p>	 <p>Overhang 2</p>	 <p>Overhang 2</p>

CRS	FS	FM	FL
Britax Frontier 85 max	Too big	Too Big	 <p data-bbox="1110 644 1203 667">LG>100</p>
Orbit Baby Toddler Car Seat	Too big	Too big	 <p data-bbox="1110 989 1252 1024">Overhang 3</p>
Sunshine Kids Radian 80SL	 <p data-bbox="418 1367 516 1394">LG> 100</p>	 <p data-bbox="764 1367 857 1394">UG>60</p>	 <p data-bbox="1110 1352 1159 1379">Fits</p>
Compass	Too big	 <p data-bbox="764 1757 813 1785">Fits</p>	 <p data-bbox="1110 1757 1159 1785">Fits</p>

CRS	FS	FM	FL
Britax Boulevard CS min	Too big	Too big	 <p data-bbox="1110 569 1203 596">LG>100</p>
Britax Boulevard CS, Max	Too big	Too big	 <p data-bbox="1110 968 1154 995">IBC</p>
Evenflo Triumph Advance Min	Too big	 <p data-bbox="764 1394 857 1421">LG>100</p>	 <p data-bbox="1110 1346 1203 1373">LG>100</p>
Evenflo Triumph Advance, max	Too big	 <p data-bbox="764 1829 857 1856">LG>100</p>	 <p data-bbox="1110 1829 1203 1856">LG>100</p>

CRS	FS	FM	FL
Evenflo Symphony min	Too big	 <p>Overhang 5.5</p>	 <p>Overhang 4.5</p>
Evenflo Symphony max	Too big	IBC	 <p>Fits</p>
Graco Comfort Sport	 <p>Too big</p>	 <p>Overhang 4</p>	 <p>Overhang 4</p>
Safety 1st Alpha Omega Elite Min	IBC	 <p>Overhang 6.5</p>	 <p>Overhang 5.5</p>





CRS	FS	FM	FL
Safety 1st Alpha Omega Elite Max	Too big	 <p data-bbox="764 621 808 653">IBC</p>	 <p data-bbox="1107 590 1203 621">LG>100</p>
Eddie Bauer Deluxe 3-in-1 min	Too big	 <p data-bbox="764 1062 927 1094">Overhang 7.5</p>	 <p data-bbox="1107 989 1252 1020">Overhang 6</p>
Eddie Bauer Deluxe 3-in-1 max	Too big	 <p data-bbox="764 1503 808 1535">IBC</p>	 <p data-bbox="1107 1472 1203 1503">LG>100</p>

CRS	FS	FM	FL
Safety 1st Scenera	 <p data-bbox="418 569 738 619">Overhang 1.25</p>	 <p data-bbox="766 569 1086 619">Overhang 1.25</p>	 <p data-bbox="1114 569 1417 619">Overhang 1.25</p>
Maxi-Cosi Rodi Fix min	 <p data-bbox="418 995 738 1060">LG > 100</p>	 <p data-bbox="766 995 1086 1060">Fits</p>	 <p data-bbox="1114 968 1417 1060">Fits</p>
Maxi-Cosi Rodi Fix max	<p data-bbox="418 1066 738 1102">Too big</p>	<p data-bbox="766 1066 1086 1102">Too big</p>	 <p data-bbox="1114 1402 1417 1501">LG > 100, UPG UG > 50</p>





CRS	FS	FM	FL
Baby Trend Trendz FastBack 3-in-1	Belt path	 Belt path	 Belt path
Graco Argos 70 min	 Overhang 5.5	 Overhang 5.5	 Overhang 5
Graco Argos 70 max	Too big	 Too big	 IBC





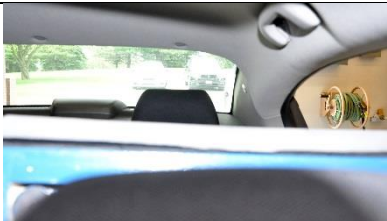

CRS	FS	FM	FL
Maxi-Cosi Pria min	 <p data-bbox="418 596 461 632">IBC</p>	 <p data-bbox="768 562 878 598">Belt path</p>	 <p data-bbox="1117 569 1227 604">Belt path</p>
Maxi-Cosi Pria max	Too big	 <p data-bbox="768 1058 813 1094">IBC</p>	 <p data-bbox="1117 1010 1208 1045">LG>100</p>
Safety 1st Guide 65 Sport	 <p data-bbox="418 1478 509 1514">LG>100</p>		 <p data-bbox="1117 1451 1224 1486">LG > 100</p>







CRS	FS	FM	FL
Safety 1st Guide 65 Sport	 <p>LG>100</p>	 <p>Fits</p>	 <p>Fits</p>
Evenflo Tribute LX	 <p>Overhang 4</p>	 <p>Overhang 4</p>	 <p>Overhang 4</p>
Graco My Ride 65	<p>Too big</p>	 <p>Too big</p>	 <p>Fits</p>







CRS	FS	FM	FL
<p>Recaro ProRide</p>	<p>Too big</p>	 <p>Too big</p>	 <p>LG>100</p>
<p>The First Years True Fit SI</p>	 <p>Too big</p>	<p>Too big</p>	 <p>LG>100</p>







Appendix D:
Envelopes in Vehicles



	Fit	Chevrolet Cruze	
RS	√		
RM	FSI		
RL	FSI, LCI		





	Fit	Ford Escape	
RS	v		
RM	v		
RL	FSI		



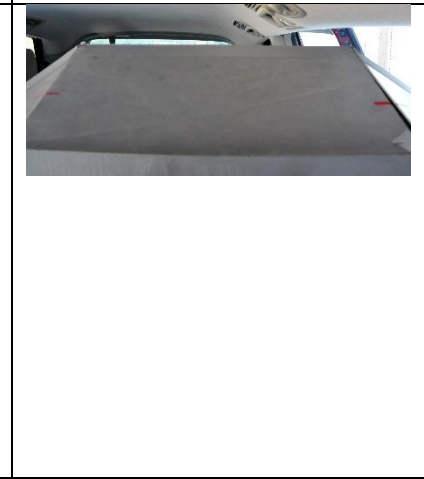

	Fit	Honda Pilot	
RS	✓		
RM	✓		
RL	FSI		

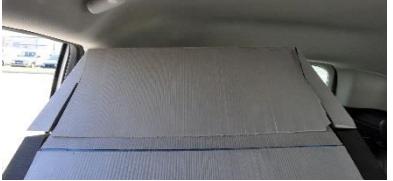



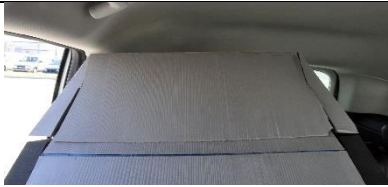

	Fit	Hyundai Elantra	
RS	√		
RM	√		
RL	FSI, LCI		







	Fit	Toyota Camry	
RS	v		
RM	v		
RL	FSI		







	Fit	Toyota Sienna (revised envelopes)	
RS	v		
RM	v		
RL	v		

	Fit	Ford Escape	
FS	√		
FM	√		
FL	√		

	Fit	Ford Focus	
FS	√		
FM	√		
FL	LCI		

	Fit	Hyundai Elantra	
FS	√		
FM	√		
FL	√		

	Fit	Nissan Sentra	
FS	v		
FM	v		
FL	LCI		

	Fit	Subaru Outback	
FS	v		
FM	v		
FL	v		

		Toyota Sienna	
FS	v		
FM	v		
FL	v		

DOT HS 812 610
September 2018



U.S. Department
of Transportation
**National Highway
Traffic Safety
Administration**

