



U.S. Department  
of Transportation  
**National Highway  
Traffic Safety  
Administration**



DOT HS 811 676

November 2012

# **2011 Crashworthiness Data System Coding and Editing Manual**

This publication is distributed by the U.S. Department of Transportation, National Highway Traffic Safety Administration, in the interest of information exchange. The opinions, findings, and conclusions expressed in this publication are those of the author(s) and not necessarily those of the Department of Transportation or the National Highway Traffic Safety Administration. The United States Government assumes no liability for its content or use thereof. If trade or manufacturers' names or products are mentioned, it is because they are considered essential to the object of the publication and should not be construed as an endorsement. The United States Government does not endorse products or manufacturers.

**Technical Report Documentation Page**

1. Report No. DOT HS 811 676		2. Government Accession No.		3. Recipient's Catalog No.	
4. Title and Subtitle 2011 Crashworthiness Data System Coding and Editing Manual				5. Report Date November 2012	
				6. Performing Organization Code NVS-411	
7. Author(s) Bean, James D. (Dave)				8. Performing Organization Report No.	
9. Performing Organization Name and Address Crash Investigation Division; Office of Data Acquisition National Highway Traffic Safety Administration Washington, DC 20590				10. Work Unit No. (TRAIS)	
				11. Contract or Grant No.	
12. Sponsoring Agency Name and Address Department of Transportation 1200 New Jersey Avenue SE. National Highway Traffic Safety Administration Washington, DC 20590				13. Type of Report and Period Covered NHTSA Technical Manual	
				14. Sponsoring Agency Code	
15. Supplementary Notes					
16. Abstract  <p>This technical manual is used by NHTSA's field research teams assigned to the Crashworthiness Data System (CDS) to perform detail crash investigations.</p> <p>CDS has detailed data on a representative, random sample of thousands of minor, serious, and fatal crashes. Field research teams located at Primary Sampling Units (PSU's) across the country study crashes involving passenger cars, light trucks, vans, and utility vehicles. Trained crash investigators obtain data from crash sites, studying evidence such as skid marks, fluid spills, broken glass, and bent guard rails. They locate the vehicles involved, photograph them, measure the crash damage, and identify interior locations that were struck by the occupants. These researchers follow up on their on-site investigations by interviewing crash victims and reviewing medical records to determine the nature and severity of injuries.</p>					
17. Key Word			18. Distribution Statement Document is available to the public through the National Technical Information Service, Springfield, Virginia 22161		
19. Security Classif. (of this report) Unclassified		20. Security Classif. (of this page) Unclassified		21. No. of Pages 1,261	22. Price



**National  
Automotive  
Sampling  
System**

**Crashworthiness  
Data  
System**

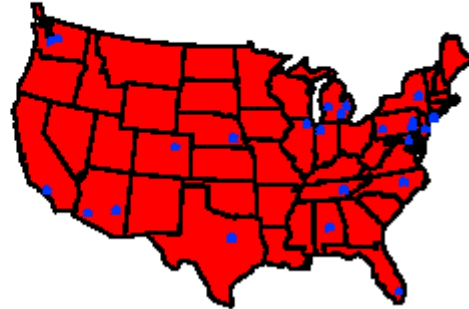

**2011  
Coding and  
Editing Manual**



United States Department of Transportation  
National Highway Traffic Safety Administration

Disclaimer:

The CDS Coding and Editing Manual is based upon and references a 31 dataset SAS file. Currently only an 11 dataset SAS file is published. Please refer to the CDS Analytical User's Manual for further information regarding the 11 dataset file.

The 11 Dataset file:

Accident  
Acc\_desc  
Event  
GV  
OA  
OI  
Pers\_pro  
Typ\_acc  
Ve  
Veh\_pro  
Vi

The 31 Dataset file:

Accdesc	Intgrty
Accident	Intrsn
Adapteq	Oa
Airbag	Oi
Bagseat	Seatloc
Case20XX	Specstdy
Cdcrsh	Tire
Chldseat	Tiredmg
Contact	Vehspec
Distract	Vi
Doors	Vsign
Edrabag	
Edrcrash	
Edrdata	
Edrprecr	
Ems	
Event	
Fueltank	
Glazing	
Gv	

## 2011 MANUAL CHANGES

Below is a list of CDS variables that have substantive changes for 2011.  
**IT IS RECOMMENDED THAT YOU REVIEW THE ENTIRE MANUAL FOR ALL CHANGES.**

FORM	TAB	PAGE #	VARIABLE	COMMENTS
Case	Structure/Case	CF-30	Number of Vehicles in Crash	Remarks change
Case	Structure/Case	CF-34	Number of Non-CDS In-transport Vehicles in Crash	Name change to Number of Non-CDS Vehicles in Crash Remarks change
Case	Structure/Case	CF-38	Vehicle Number	Remarks change
Case	Structure/Case	CF-39	Type of Vehicle	Remarks change
Case	Structure/Case	CF-45	Interview Required	Definition change for "No"
Case	Structure/Case	CF-50	Vehicle Number	Remarks change
Case	Structure/Case	CF-90	Crash Events Overview	Remarks change
Case	Structure/Comment			Retire Sub tab

GV	Vehicle	GV-4	Vehicle Number	Remarks/Note change
GV	Vehicle	GV-8	Vehicle Body Category	New attribute: Buses (Excludes Van Based GVWR≤4,536kgs)
GV	Vehicle	GV-12	Body Type	Attribute change: Buses (Excludes Van Based GVWR≤4,536kgs) and Low Speed Vehicles (LSV)/Neighborhood Electric Vehicle (NEV)
GV	Vehicle	GV-12	Body Type	Attribute change: Single unit straight truck (4,536<GVWR≤8,845kgs) changed to Single unit straight truck/Cab chassis (4,536<GVWR≤8,845kgs)
GV	Specifications		Researcher's Assessment of Vehicle Disposition	Retired
GV	Specifications		Justification for Researcher's Assessment of Vehicle Disposition	Retired
GV	Specifications	GV-53	Engine Cylinders	Attribute added: Not Applicable
GV	Specifications	GV-54	Engine Displacement	Attribute added: Not Applicable
GV	Pre-crash	GV-123	Pre-crash General Rules	Changed Rule, 1,2,3,4,and 6
GV	Pre-crash	GV-137	Pre-event Movement	Roadway changed to Road Traffic Lane changed to Road

<b>FORM</b>	<b>TAB</b>	<b>PAGE #</b>	<b>VARIABLE</b>	<b>COMMENTS</b>
GV	Preocrash	GV-142	Critical Preocrash Event	Roadway changed to Road Intersection changed to Junction
GV	Preocrash	GV-152	Attempt Avoidance Maneuver	Source change

EV	Vehicle	EV-8	Body Type	Remarks change
EV	Vehicle	EV-39	Inspection Type	Add attribute: Partial Inspection-MY Greater than 10 years
EV	Specifications		Researcher's Assessment of Vehicle Disposition	Retired
EV	Specifications		Justification for Researcher's Assessment of Vehicle Disposition	Retired
EV	Tire/Detail	EV-58	Manufacturer List	Add manufacturers to list
EV	Tire/Detail	EV-71	Tire Damage	New definition: Tire De-beaded, Other (specify)
EV	Specifications	EV-83	Engine Cylinders	Attribute added: Not Applicable
EV	Specifications	EV-84	Engine Displacement	Attribute added: Not Applicable
EV	Fuel	EV-93	Fuel Type	New attributes: Gasoline/Ethanol (E85), Gasoline/Methanol (M85), Ethanol (E100), Methanol (M100), Lithium-ion Battery Retired attributes: Ethanol (E85/E100), Methanol (M85/M100)
EV	Crush/Profile	EV-137	Rollover Documentation	Remarks change for CDC
EV	CDC/Details	EV-140	[Deformation Number]	Remarks change: Added cable barrier guardrail.
EV	CDC/Details	EV-153	Deformation Location	Remarks change for Rollover Crashes
EV	EDR	EV-196	EDR Information Obtained?	Remarks change Definition change: Permission not received
EV	EDR	EV-200	Accident Event Sequence Number	Remarks change
EV	EDR	EV-204	Complete File Recorded	New variable
EV	EDR	EV-205	Multi-Event, Number of Events	New variable
EV	EDR	EV-206	Time from Event 1 to 2	New variable
EV	EDR	EV-207	Imaging Method	New variable
EV	EDR/Preocrash	EV-223	Number of Seconds Prior to Crash	Range change. Remarks change.

<b>FORM</b>	<b>TAB</b>	<b>PAGE #</b>	<b>VARIABLE</b>	<b>COMMENTS</b>
EV	EDR/Preocrash	EV-224	Vehicle Speed Reading	Name change. Remarks change.
EV	EDR/Preocrash	EV-225	Engine Speed Reading	Name change. Remarks change.
EV	EDR/Preocrash	EV-226	Throttle Percentage Reading	Name change. Remarks change.
EV	EDR/Preocrash	EV-227	Brake Status	Name change. Remarks change.

SS	Child Restraint	SS-73		Child Restraint Overview change
SS	Child Restraint	SS-78	Make	New remarks
SS	Child Restraint	SS-79	Model	New remarks
SS	Child Restraint	SS-81	How Used	New variable
SS	Child Restraint	SS-88	Date of Manufacture	New remarks
SS	Child Restraint	SS-89	Model No.	Display in all Caps New remarks
SS	Child Restraint	SS-90	Source of Data	New remarks
SS	Child Restraint	SS-92	Harness/Shield Design	New remarks
SS	Child Restraint	SS-95	Retainer Clip	Name change. New remarks
SS	Child Restraint	SS-96	Tether Design	New remarks
SS	Child Restraint	SS-97	LATCH Anchor Hook Design	Name change. New remarks
SS	Child Restraint	SS-99	Usage Orientation	New remarks
SS	Child Restraint	SS-100	Harness/Shield Use	New remarks. Attribute change.
SS	Child Restraint	SS-102	Retainer Clip Use	New remarks. Attribute change: Harness
SS	Child Restraint	SS-103	Tether Use	New remarks
SS	Child Restraint	SS-104	LATCH Anchor Hook Use	New name. New attribute names.
SS	Child Restraint	SS-105	Belt Routing/Use	New definitions
SS	Child Restraint	SS-107	Locking Clip on Vehicle Belt	New remarks. New definitions
SS	Child Restraint	SS-109	Seat Location	New attribute: Unknown New remarks
SS	Child Restraint	SS-111	Restraint Placement	New definitions
SS	Child Restraint	SS-112	Position in Child Restraint	New definitions
SS	Child Restraint		Tab Change	Rename: Design Feature Used to Design Features Available

OA	Child Restraint			Tab name change: Child Restraint
OA	Child Restraint	OF-104	Child Restraint Overview	Remarks change
OA	Child Restraint	OF-108	Make	Remarks change
OA	Child Restraint	OF-109	Model	Remarks change
OA	Child Restraint	OF-110	Type	Remarks change



<b>FORM</b>	<b>TAB</b>	<b>PAGE #</b>	<b>VARIABLE</b>	<b>COMMENTS</b>
OA	Child Restraint	OF-111	How Used	New remarks. New definition
OA	Child Restraint	OF-119	Date of Manufacturer	Remarks change
OA	Child Restraint	OF-120	Model Number	Remarks change
OA	Child Restraint	OF-121	Source of Data	Remarks change
OA	Child Restraint	OF-122	Harness/Shield Design	Remarks change
OA	Child Restraint	OF-125	Retainer Clip	Remarks change
OA	Child Restraint	OF-126	Tether Design	Remarks change
OA	Child Restraint	OF-127	LATCH Anchor Hook Design	Name change. Remarks change
OA	Child Restraint	OF-129	Usage Orientation	Source change. Definition change
OA	Child Restraint	OF-138	Seat Location	New attribute: Unknown

## Table of Contents

### 2011 Changes

#### CASE FORM

##### Case Form Overview

CF-1

##### Required Forms

CF-2

##### Vehicle Fully Repaired-No Damage Evident

CF-7

###### CRASH

CF-9

Case Number

CF-10

Stratum

CF-11

Date of Crash (Month/Day/Year)

CF-12

Time of Crash

CF-13

PSU

CF-14

Police Jurisdiction

CF-15

PAR Number

CF-16

Researcher Assigned To Case

CF-17

Status of Case

CF-18

Special Studies

CF-21

Case Due Date

CF-22

Case Identification Number

CF-23

Type of Case

CF-24

Case Owner

CF-26

###### STRUCTURE OVERVIEW

CF-27

###### STRUCTURE/CASE

CF-29

Total Number of Vehicles in Crash

CF-30

Number of CDS In Transport Vehicles in Crash

CF-32

Number of CDS Not In Transport Vehicles in Crash

CF-33

Number of Non CDS In Transport Vehicles in Crash

CF-34

Total Number of Occupants in CDS Vehicles In Transport

CF-35

Total Number of Medical Records in Case

CF-36

###### STRUCTURE/VEHICLES

CF-37

Vehicle Number

CF-38

Type of Vehicle

CF-39

Date of Vehicle Inspection

CF-40

Number of Occupants in This Vehicle

CF-41

###### STRUCTURE/OCCUPANTS

CF-42

Vehicle Number

CF-43

Occupant Number

CF-44

Interview Required

CF-45

Interview Completion Date

CF-46

Interview Results

CF-47

###### STRUCTURE/MEDICAL RECORDS

CF-48

###### STRUCTURE/MEDICAL RECORDS/DETAIL

CF-48

Vehicle Number

CF-49

Occupant Number

CF-50

Medical Record

CF-51

Medical Facility

CF-55

Medical Release

CF-56

Date that Medical Record was Requested

CF-57

Date that Medical Record was Received

CF-58

Date that Medical Record was Forwarded to Zone Center

CF-59

Medical Record Obtained or Reason Why Not

CF-60

###### STRUCTURE/COMMENT

CF-61

###### SUMMARY/CASE SUMMARY

CF-62

Crash Type	CF-63
Crash Configuration	CF-64
Case Summary Overview	CF-66
[Data Entry Field for Case Summary]	CF-67
Case Summary	CF-68
SUMMARY/VEHICLES	CF-69
Vehicle Number	CF-70
Vehicle Year	CF-71
Vehicle Make	CF-72
Vehicle Model	CF-73
Damage Plane	CF-74
Damage Severity	CF-75
Component Failure	CF-76
SUMMARY/OCCUPANTS	CF-79
Vehicle Number	CF-80
Person Role	CF-81
Seat Position	CF-82
Restraints Use	CF-83
AIS Code	CF-84
Injury Severity	CF-85
Injury Source	CF-86
EVENTS/SUMMARY	CF-87
EVENTS/DETAIL	CF-88
Crash Events Overview	CF-89
Event Number	CF-91
Vehicle Number	CF-92
[Class of Vehicle]	CF-93
General Area of Damage	CF-98
Object Contacted	CF-100
[Class of Vehicle Contacted]	CF-110
General Area of Damage of Vehicle Contacted	CF-112
SCENE	CF-113
Date Scene Completed	CF-115
ANNOTATIONS	CF-116
REVIEW/PSU REVIEW	CF-118
REVIEW/ZONEIEW	CF-120
OTHER RESPONSES	CF-122

# GENERAL VEHICLE FORM

## General Vehicle Form Overview

VEHICLE	GV-1
Vehicle Number	GV-3
Vehicle Model Year	GV-4
Vehicle Make	GV-5
Vehicle Model	GV-6
Vehicle Body Category	GV-7
Body Type	GV-8
[Class of Vehicle]	GV-10
Vehicle Identification Number (VIN)	GV-23
Vehicle Special Use	GV-28
Transport Status	GV-30
Curb Weight	GV-33
Source of Curb Weight Information	GV-36
Cargo Weight	GV-37
Source of Cargo Weight Information	GV-39
Inspection Type	GV-40
Date of Inspection	GV-41
SPECIFICATIONS	GV-43
Wheelbase	GV-44
Overall Length	GV-45
Maximum Width	GV-47
Curb Weight	GV-48
Average Track Width	GV-49
Front Overhang	GV-50
Rear Overhang	GV-51
Undeformed End Width	GV-52
Engine Cylinders	GV-53
Engine Displacement	GV-54
Type of Transmission	GV-55
Drive Wheels	GV-56
Multi-Stage or Altered Vehicle	GV-57
Suspected Post Manufacturer Modifications	GV-58
OFFICIAL RECORDS	GV-61
Police Reported Tow Status	GV-62
Police Reported Travel Speed	GV-63
Posted Speed Limit	GV-65
Is the Driver Present?	GV-66
Occupant Number	GV-67
[Number of Occupant Forms]	GV-68
Police Reported Alcohol Presence	GV-70
Alcohol Test for Driver	GV-71
Alcohol Test Result	GV-73
Source of Alcohol Test Result	GV-75
Other Drugs Overview	GV-76
Police Reported Other Drug Presence	GV-77
Other Drug Test Result	GV-78
Driver's Zip Code	GV-80
Race	GV-82
Ethnicity	GV-84
PRECRASH	GV-87
ENVIRONMENT	GV-89
PreCrash Data Overview	GV-89
Relation to Interchange or Junction	GV-90

Trafficway Flow	GV-96
Number of Travel Lanes	GV-98
Roadway Alignment	GV-100
Roadway Profile	GV-101
Roadway Surface Type	GV-103
Roadway Surface Condition	GV-105
Lighting Conditions	GV-106
Weather Conditions	GV-107
Traffic Control Device	GV-110
Traffic Control Device Functioning	GV-115
MOVEMENT	GV-116
Precrash Data Overview	GV-117
Crash Envelope	GV-117
Simple Single Critical Crash Envelope	GV-118
Complex Single Critical Crash Envelope	GV-118
Multiple Critical Crash Envelopes	GV-119
Precrash Methodology Flowchart	GV-122
Precrash General Rules	GV-123
Example 1	GV-125
Example 2	GV-127
Example 3	GV-129
Example 4	GV-131
Example 5	GV-132
Example 6	GV-134
Example 7	GV-136
Pre-Event Movement (Prior to Recognition of Critical Event)	GV-137
Critical Pre Crash Category	GV-140
Critical Precrash Event	GV-142
This Vehicle Loss Of Control	GV-143
This Vehicle Traveling	GV-144
Other Motor Vehicle In Lane	GV-145
Other Motor Vehicle Encroaching Into Lane	GV-146
Pedestrian or Pedalcyclist, or Other Nonmotorist	GV-148
Object or Animal	GV-149
Precrash Event Scenarios for Different Rear-End Collision Situations	GV-150
Attempted Avoidance Maneuver	GV-152
Pre-Impact Stability	GV-154
Pre-Impact Location	GV-156
Crash Type	GV-158
Crash Types Chart	GV-160
Crash Category	GV-161
Crash Configuration	GV-163
Single Driver	GV-164
Same Trafficway, Same Direction	GV-164
Same Trafficway, Opposite Direction	GV-164
Changing Trafficway, Vehicle Turning	GV-164
Intersecting Paths (Vehicle Damage)	GV-165
Miscellaneous	GV-165
Crash Types	GV-166
Crash Category: Single Driver	GV-169
Crash Category: Same Trafficway, Same Direction	GV-173
Crash Category: Same Trafficway, Opposite Direction	GV-180
Crash Category: Changing Trafficway, Vehicle Turning	GV-184
Crash Category: Intersecting Paths (Vehicle Damage)	GV-188
Crash Category: Miscellaneous	GV-189
DRIVER / DISTRACTIONS	GV-191

Driver's Distraction/Inattention to Driving	GV-192
Driver's Distraction	GV-194
ROLLOVER	GV-197
Rollover Data Overview	GV-197
Rollover Type	GV-198
Number of Quarter Turns	GV-200
Interrupted Roll	GV-202
Pre-rollover Maneuver	GV-203
Rollover Initiation Type	GV-205
Location of Rollover Initiation	GV-210
Rollover Initiation Object Contacted Class	GV-212
Rollover Initiation Object Contacted	GV-214
Location on Vehicle Where Initiating Rollover Force is Applied	GV-223
Direction of Initial Roll	GV-225
Estimated distance from trip point to final rest position	GV-226
RECONSTRUCTION	GV-228
Type of Impact for Highest Delta V	GV-229
Heading Angle for This Vehicle	GV-230
Heading Angle for Other Vehicle	GV-232
Towed Trailing Unit	GV-234
Documentation of Trajectory Data	GV-235
Post Collision Condition of Tree or Pole	GV-236
DELTAV	GV-238
Event Number for Highest Severity Impact	GV-239
Basis for Computer Generated Delta V for Highest Severity Impact	GV-240
Total Delta V for Highest Severity Impact	GV-244
Longitudinal Delta V for Highest Severity Impact	GV-245
Lateral Delta V for Highest Severity Impact	GV-246
Energy Absorption for Highest Severity Impact	GV-247
Impact Speed for Highest Severity Impact	GV-248
Confidence Level for Highest Severity Impact	GV-249
Barrier Equivalent Speed for Highest Severity Impact	GV-251
Estimated Severity for Highest Severity Impact	GV-252
LOG/PSU	GV-253
Reason Vehicle Inspection Not Completed	GV-254
REVIEW	GV-258
PSU Review	GV-259
ZONE Review	GV-260

## **EXTERIOR VEHICLE FORM**

	EV-1
Vehicle Number	EV-2
Vehicle Model Year	EV-3
Vehicle Make	EV-4
Vehicle Model	EV-5
Vehicle Body Category	EV-6
Body Type	EV-8
[Class of Vehicle]	EV-20
Vehicle Identification Number (VIN)	EV-25
Vehicle Special Use	EV-27
In Transport	EV-30
Curb Weight	EV-33
Source of Curb Weight Information	EV-35
Cargo Weight	EV-37
Source of Cargo Weight Information	EV-38
Inspection Type	EV-39
Date of Inspection	EV-41
<b>TIRE OVERVIEW</b>	EV-42
<b>TIRES GENERAL</b>	EV-48
Total Gross Vehicle Weight Rating (kgs)	EV-49
Front Gross Axle Weight Rating (kgs)	EV-50
Rear Gross Axle Weight Rating (kgs)	EV-51
Manufacturer's Recommended Front/Rear Tire Size	EV-52
Manufacturer Recommended Tire Pressure – Cold – Front/Rear (kilopascals)	EV-55
<b>TIRE / TIRES / LIST</b>	EV-56
<b>TIRE / TIRES / DETAIL</b>	EV-56
Tire Location	EV-57
Tire manufacturer	EV-58
Tire Manufacturer List	EV-59
Tire model	EV-61
Tire type On Vehicle	EV-62
Tire size On Vehicle	EV-63
Tire Identification Number	EV-64
Minimum Tread Depth (mm)	EV-68
Tire Measured Pressure (kilopascals)	EV-69
Tire Restricted	EV-70
Tire Damage	EV-71
<b>SPECIFICATIONS</b>	EV-74
Wheelbase	EV-75
Overall Length	EV-76
Maximum Width	EV-77
Curb Weight	EV-78
Average Track Width	EV-79
Front Overhang	EV-80
Rear Overhang	EV-81
Undeformed End Width	EV-82
Engine Cylinders	EV-83
Engine Displacement	EV-84
Type of Transmission	EV-85
Drive Wheels	EV-86
Multi-Stage or Altered Vehicle	EV-87
Suspected Post Manufacturer Modifications	EV-90
<b>FUEL SYSTEMS</b>	EV-91
Fuel System Number	EV-92
Fuel Type	EV-93
Damage to Fuel Cell	EV-96

Fuel System Leakage Location	EV-98
Location of Fuel Cell	EV-100
Type of Fuel Cell	EV-102
Location of Filler Cap	EV-106
PreCrash Condition of Fuel Cell	EV-108
FIRE	EV-110
Fire Occurrence	EV-111
Origin of Fire	EV-113
CRUSH LOCATION	EV-116
Profile Number	EV-117
Event Number	EV-118
Direct Damage Location	EV-119
Location of Field L	EV-120
Location of Max Crush	EV-121
CRUSH PROFILE	EV-122
Profile Number	EV-123
CDC Number	EV-124
Field L	EV-125
WinSMASH L	EV-126
Field L +/- D	EV-127
Direct +/- D	EV-128
Category	EV-129
Width (CDC)	EV-130
Vertical level at which crush measurements are taken for a particular crush profile.	EV-131
Maximum crush for this vertical level of crush measurements for this crush profile	EV-135
C1, C2, C3, C4, C5, C6	EV-136
Rollover Documentation	EV-137
CDC / SUMMARY	EV-138
CDC / DETAIL	EV-138
Event Number	EV-139
[Deformation Number]	EV-140
General Area of Damage	EV-141
Object Contacted Category and Object	EV-142
Direction of Force	EV-144
[Clock]	EV-145
Increment of Clock Direction	EV-146
Override/Underride (this vehicle)	EV-148
Heading Angle	EV-151
Deformation Location	EV-153
Specific Longitudinal or Lateral Location	EV-155
Specific Vertical or Lateral Location	EV-156
Type of Damage Distribution	EV-157
Deformation Extent Guide	EV-158
Side Impact Data	EV-159
Direct Damage to Pillar(s)	EV-160
Vertical Height of Sill	EV-162
Height of Max Door Crush	EV-164
Door Sill Differential	EV-166
WinSMASH Overview	EV-168
Table Of Weights To Be Used For Known Occupants With Unknown Weight	EV-175
Male	EV-175
Female	EV-175
NassMain WinSMASH	EV-177
Delta V, Barrier Equivalent And Speed Estimate Decision Rules	EV-177
Definitions for Minor, Moderate, or Severe	EV-179
Total Delta V	EV-181



Longitudinal Delta V	EV-182
Lateral Delta V	EV-183
Energy Absorption	EV-184
Impact Speed or change to Impact	EV-185
Barrier Equivalent Speed	EV-186
Estimated Severity	EV-187
Severity Rank	EV-190
Basis for Delta V Entry	EV-191
<b>EDR DATA</b>	EV-194
EDR Information Obtained	EV-196
CDR/EDR Version Number	EV-199
Warning Lamp Status	EV-200
Accident Event Sequence Number	EV-201
Type of event	EV-202
Complete File Recorded	EV-203
Multi-Event, Number of Events	EV-204
Time from Event 1 to 2	EV-205
Imaging Method	EV-206
Number Of Ignition Cycles At Event Occurrence	EV-207
Number Of Ignition Cycles At Investigation	EV-208
Driver's Belt Status	EV-209
Time For Driver Pretensioner Actuation	EV-210
Driver Seat Track In Forward Position	EV-211
Passenger's Belt Status	EV-212
Passenger's Seat Weight Sensor Position	EV-213
Time For Passenger Pretensioner Actuation	EV-214
Passenger Air Bag Suppression Switch Position	EV-215
<b>AIR BAG DEPLOYMENT TIMES</b>	EV-216
Air Bag Location	EV-217
Position	EV-219
Time For First Stage Air Bag Deployment	EV-220
Time For Second Stage Air Bag Deployment	EV-221
EDR Precrash Data	EV-222
Number of seconds Prior to Crash	EV-223
Precrash Vehicle Speed Reading (-5, -4, -3, -2, -1)	EV-224
Precrash Engine Speed Reading (-5, -4, -3, -2, -1)	EV-225
Precrash Engine Throttle Percentage (-5, -4, -3, -2, -1)	EV-226
Precrash Brake Status (-5, -4, -3, -2, -1)	EV-227
EDR Crash Data	EV-228
Longitudinal Delta V	EV-228
Number of Milliseconds After Crash	EV-229
Longitudinal Delta V Reading	EV-230
Time For Lateral Delta V	EV-231
Lateral Delta V Reading	EV-232
<b>INSTRUCTIONS FOR COMPLETION OF VEHICLE DAMAGE SKETCH</b>	EV-233
Vehicle Types	EV-234
Top View Example	EV-235
Side View Example	EV-236
End View Example	EV-237
<b>SKETCHES/MEASUREMENTS</b>	EV-238
Side Door Lateral Width	EV-239
Side Glass Later Width	EV-240
Roof Lateral Width	EV-241
Side Door Vertical Height	EV-242
Side Glass Vertical Height	EV-243
Roof Vertical Height	EV-244

Original Front Bumper Height	EV-245
Original Rear Bumper Height	EV-246
Front Track Width (Post Crash)	EV-247
Rear Track Width (Post Crash)	EV-248
Original Hood Extent	EV-249
Original Windshield Extent	EV-250
Original Windshield to B-pillar	EV-251
Original Backlight to B-pillar Length	EV-252
Original Backlight Length	EV-253
Original Trunk Length	EV-254
Original Pick-up Rear Extent	EV-255
Original Pick-up Bed Length	EV-256
Baseline Measurement-Left/Right Side Front Stringline	EV-257
Baseline Measurement-Left/Right Side Front Corner	EV-258
Baseline Measurement-Left/Right Side Wheelbase	EV-259
Baseline Measurement-Left/Right Side Corner	EV-260
Baseline Measurement-Left/Right Side Rear Stringline	EV-261
LOG	EV-262
Applicable Precrash Measurements	EV-264
Reference Line Placement	EV-265
Impact Damage Documentation	EV-266
Quality of Vehicle Damage Sketch	EV-267
Exterior Images Subject Quality	EV-268
Exterior Image Quality	EV-269
Primary Error Source (Vehicle Plane)	EV-270
REVIEW	EV-271
PSU List	EV-271
PSU Detail	EV-272

<b>INTERIOR VEHICLE FORM</b>	IV-1
INTEGRITY	IV-1
[Is There Passenger Compartment Integrity Loss?]	IV-2
Passenger Compartment Integrity	IV-3
Post Crash Integrity Loss	IV-5
Door; Tailgate; or Hatch Opening Review	IV-6
Door, Tailgate, or Hatch Location	IV-7
Door, Tailgate, or Hatch Opening	IV-8
Damage/Separation Associated with Door, Tailgate, or Hatch Opening in Collision	IV-10
GLAZING	IV-12
Glazing Type and Damage Overview	IV-13
Location of Window/Windshield Glazing	IV-15
Type of Window/Windshield Glazing	IV-16
Window Precrash Status	IV-19
Glazing Damage From Impact Forces	IV-21
Glazing Damage from Occupant Contact	IV-24
INTRUSION/OCCUPANT AREA INTRUSION OVERVIEW	IV-26
Row Widths	IV-30
INTRUSIONS	IV-32
INTRUSIONS DETAIL	IV-32
[Intrusion Number]	IV-33
Row	IV-34
Position	IV-37
[Intrusion Location]	IV-39
Area	IV-42
Intruded Component	IV-43
Comparison Value (of intrusion)	IV-48
Intruded Value (of intrusion)	IV-49
Intrusion	IV-50
Magnitude of Intrusion	IV-51
Crush Direction	IV-52
INTRUSION/SKETCH	IV-53
Intrusion Sketch Completion	IV-54
INSTRUMENT	IV-55
Odometer Reading	IV-56
Odometer Source	IV-57
Adjustable Pedals	IV-58
Adaptive (Assistive) Driving Equipment Yes/No/Unknown	IV-59
Adaptive (Assistive) Driving Equipment	IV-60
STEERING COLUMN	IV-62
Steering Column Type	IV-63
Tilt Steering Column Adjustment	IV-65
Telescoping Steering Column Adjustment	IV-67
Location of Rim / Spoke Deformation	IV-69
Steering Rim / Spoke Deformation	IV-71
STEERING WORKSHEET	IV-73
Comparison Value	IV-74
Damage Value	IV-75
Deformation	IV-76
STEERING DRAWING	IV-77
CONTACT/LIST	IV-78
CONTACT/CONTACT	IV-78
Contact Overview	IV-79
Contact	IV-81
Contact Area Label	IV-82
Contacted Component	IV-83

Occupant Number	IV-89
Body Region	IV-90
Evidence	IV-92
Confidence Level of Occupant Contact	IV-95
CONTACT / SKETCH 1 AND SKETCH 2	IV-96
Instructions for Completion of Vehicle Interior Sketches	IV-97
EJECTION OVERVIEW	IV-100
EJECTION LIST	IV-102
Ejection List Tab	IV-102
EJECTION DETAIL	IV-103
Ejection Number	IV-104
Ejection - Type	IV-105
Ejection Area	IV-107
Ejection Medium	IV-109
Ejection Medium Status	IV-111
ENTRAPMENT OVERVIEW	IV-113
Entrapment Comment	IV-114
LOG	IV-115
REVIEW	IV-116
PSU Review	IV-116
Zone Review	IV-117

## **SAFETY SYSTEMS FORM**

SAFETY SYSTEMS FORM OVERVIEW	SS-1
SEAT	SS-3
SEAT DEFINITION	SS-4
Occupant's Seat Position	SS-5
Seat Type	SS-7
Seat Orientation	SS-11
Seat Track Position	SS-12
Seat Performance	SS-14
Does the Seat Have Integrated Passenger Belts?	SS-17
Restraint Type at This Occupant Position	SS-18
Head Restraint Damage by Occupant at This Occupant Position	SS-20
Active Head Restraint	SS-21
Rollover Protection	SS-22
Seat back Incline Prior to Impact	SS-23
Seat Back Incline Position Post Impact	SS-24
Air Bag ever Available	SS-25
RESTRAINTS MANUAL BELT	SS-26
Manual (Active) Belt System Availability	SS-27
Manual (Active) Belt System Used in this Crash?	SS-29
Manual (Active) Belt Malfunction Modes During Crash	SS-31
Manual Shoulder Belt Upper Anchorage Adjustment	SS-33
RESTRAINTS/MANUAL/COMPONENTS	SS-35
Pretensioner Presence/Actuation	SS-36
Pretensioner Distance	SS-38
Seat Belt Positioning Device Presence	SS-39
AIR BAG OVERVIEW	SS-41
AIR BAG	SS-43
Air Bag Number for this Vehicle	SS-44
Seat Location for Air bag(s) Data	SS-45
Deployment Location of Air Bag	SS-46
Air Bag Status	SS-48
Type of Air Bag	SS-49
Air Bag Deployment	SS-50
Indications of Air Bag Malfunction	SS-52
Type of Cutoff Switch	SS-53
Cutoff Switch Position Status	SS-54
Did Air Bag Module Cover Flap(s) / Seams Open at Designated Tear Points?	SS-55
Were the Cover Flap(s) Damaged	SS-56
Was there damage to the air bag?	SS-57
Source of Air Bag Damage	SS-59
AIR BAG SKETCHES	SS-61
CHILD RESTRAINT OVERVIEW	SS-72
CHILD SEAT LIST	SS-74
CHILD SEAT DETAIL	SS-75
[Child Restraint Number]	SS-76
Child Restraint Make	SS-77
Child Restraint Model	SS-78
Child Restraint Type	SS-79
Child Restraint How Used	SS-80
Date of manufacture	SS-88
Model Number	SS-89
Source of Data	SS-90
Child Restraint Usage Orientation	SS-91
Child Restraint Harness/Shield Design	SS-92
Child Restraint Harness Retainer Clip	SS-95

Child Restraint Tether Design	SS-96
Child Restraint LATCH Anchor Hook Design	SS-97
Child Restraint Harness/Shield Use	SS-100
Child Restraint Retainer Clip Use	SS-102
Child Restraint Tether Use	SS-103
Child Restraint LATCH Anchor Hook Use	SS-104
Belt Routing/Use	SS-105
Use of Locking Clip on Vehicle Belt	SS-107
Seat Location for Child Restraint	SS-109
Child Restraint Placement	SS-111
Child Position In Child Restraint	SS-112
VEHICLE	SS-114
Belt Retractor Type	SS-115
Latch Plate Type	SS-117
Latch Anchor	SS-119
Latch Tether	SS-120
LOG	SS-121
REVIEW PSU	SS-122
REVIEW ZONE	SS-123

<b>OCCUPANT FORM</b>	OF-1
OCCUPANT OVERVIEW	OF-2
Occupant Number	OF-3
Occupant's Age	OF-4
Occupant's Height	OF-5
Occupant's Weight	OF-6
Occupant's Sex	OF-7
Fetal Mortality	OF-9
Occupant's Role	OF-10
Race	OF-11
Ethnicity	OF-13
Occupant's Eye Wear	OF-15
Child Safety Seat Used	OF-16
Police Reported Air Bag Availability/Function	OF-17
Police Reported Belt Use	OF-18
Police Injury Severity	OF-19
EJECTION OVERVIEW	OF-29
EJECTION LIST	OF-31
EJECTION DETAIL	OF-31
Type of Ejection	OF-32
Ejection Area	OF-34
Ejection Medium	OF-36
Ejection Medium Status	OF-38
EJECTION COMMENTS	OF-40
ENTRAPMENT OVERVIEW	OF-41
ENTRAPMENT DETAILS	OF-42
Entrapment	OF-43
Occupant Mobility	OF-45
ENTRAPMENT COMMENTS	OF-47
SEAT DEFINITION	OF-48
Occupant's Seat Position	OF-49
Occupant's Posture	OF-52
Occupant's Role	OF-55
SEAT ATTRIBUTES	OF-56
Seat Type	OF-57
Seat Orientation	OF-61
Seat Track Position	OF-63
Seat Performance	OF-65
Does the Seat Have Integrated Passenger Belts?	OF-68
Head Restraint Type at This Occupant Position	OF-69
Head Restraint Damage by Occupant at This Occupant Position	OF-71
Active Head Restraint	OF-72
Rollover Protection	OF-73
Seat back Incline Prior to Impact	OF-74
Seat Back Incline Position Post Impact	OF-75
Air Bag Ever Available	OF-76
AIR BAG FUNCTION	OF-77
[Air Bag Number for this Vehicle]	OF-78
Location of Air Bag	OF-79
Air Bag Status	OF-81
Type of Air Bag	OF-82
Air Bag Deployment	OF-83
Indications of Air Bag Malfunction	OF-85
Type of Cutoff Switch	OF-86
Cutoff Switch Position Status	OF-88
AIR BAG DAMAGE	OF-89

Did Air Bag Module Cover Flap(s)/Seam(s) Open at Designated Tear Points?	OF-90
Were the Cover Flap(s) Damaged	OF-91
Was There Damage To The Air Bag?	OF-92
Source of Air Bag Damage	OF-94
AIR BAG/EVALUATION	OF-96
Had the Vehicle Been in Previous Crashes?	OF-97
Had Any Prior Maintenance/Service Been Performed On This Air Bag System?	OF-99
Air Bag Deployment Accident Event Sequence Number	OF-100
CDC For Air Bag Deployment Impact	OF-101
CHILD RESTRAINT OVERVIEW	OF-102
CHILD SEAT LIST	OF-104
CHILD SEAT DETAIL	OF-105
[Child Restraint Number]	OF-106
Child Restraint Make	OF-107
Child Restraint Model	OF-108
Child Restraint Type	OF-109
Child Restraint How Used	OF-110
Date of manufacture	OF-118
Model Number	OF-119
Source of Data	OF-120
Child Restraint Harness/Shield Design	OF-121
Child Restraint Harness Retainer Clip	OF-124
Child Restraint Tether Design	OF-125
Child Restraint LATCH Anchor Hook Design	OF-126
Child Restraint Usage Orientation	OF-128
Child Restraint Harness/Shield Use	OF-129
Child Restraint Retainer Clip Use	OF-131
Child Restraint Tether Use	OF-132
Child Seat LATCH Anchor Hook Use	OF-133
Belt Routing/Use	OF-134
Use of Locking Clip on Vehicle Belt	OF-136
Seat Location for Child Restraint	OF-138
Child Restraint Placement	OF-140
Child Position In Child Restraint	OF-141
VEHICLE	OF-143
Belt Retractor Type	OF-144
Latch Plate Type	OF-146
LATCH Anchor Availability	OF-148
LATCH Tether Availability	OF-149
MANUAL SEAT BELT	OF-150
Manual (Active) Belt System Availability	OF-151
Manual (Active) Belt System Used in This Crash?	OF-154
Position of Manual Belt/Lap Portion	OF-157
Position of Manual Belt/Shoulder Portion	OF-159
Manual (Active) Belt Failure Modes During Crash	OF-161
Manual Shoulder Belt Upper Anchorage Adjustment	OF-163
Source of Researcher's Determination of Belt Use	OF-165
MANUAL SEAT BELT COMPONENTS	OF 166
Seat Belt Positioning Device Presence	OF-167
Seat Belt Positioning Device Use	OF-169
INJURY/PSU	OF-170
[Police Injury Severity]	OF-171
Mortality	OF-180
Treatment	OF-181
Type of Medical Facility (for Initial Treatment)	OF-183
Hospital Stay	OF-186



Working Days Lost	OF-188
INJURY-ZONE	OF-190
Death Date	OF-191
Death Time	OF-192
[Time to Death]	OF-193
[Number of Injuries for This Occupant]	OF-194
Glasgow Coma Scale (GCS) Score (at Medical Facility)	OF-195
Was the Occupant Given Blood?	OF-197
Arterial Blood Gases -- ABG (HCO3)	OF-199
Medically Reported Cause of Death	OF-202
INJURY CODES LIST	OF-204
INJURY CODES DETAIL	OF-204
Injury Number	OF-205
AIS Code	OF-206
Injury Description	OF-207
Aspect	OF-208
Source of Data	OF-211
Air Bag Location	OF-213
Injury Source	OF-214
Confidence Level	OF-219
Direct Intrusion	OF-221
Indirect Intrusion	OF-222
Air Bag Related	OF-223
Direct/Indirect Injury	OF-224
Injury Rank	OF-226
Medical Record Type	OF-227
VITAL SIGNS	OF-229
MANNEQUINS	OF-230
LOG/INTERVIEW	OF-231
LOG/MEDICAL	OF-238
PSU REVIEW	OF-239
ZONE REVIEW	OF-240
EMERGENCY MEDICAL SERVICE (EMS) OVERVIEW	OF-241
VEHICLES	OF-242
[EMS Unit Number]	OF-243
Responding Agency	OF-244
Responding Emergency Vehicle Type	OF-246
Transportation Mode	OF-247
Notification Time	OF-248
Arrival Time	OF-249
Time of Departure From the Scene	OF-250
Arrived at Medical Facility	OF-251
EMS CARE	OF-252
Vehicle #	OF-253
Occupant #	OF-254
Type of EMS Care Administered	OF-255
VITAL SIGNS	OF-257
[Vital Sign Number]	OF-258
Time of Reading	OF-259
Pulse	OF-260
[Elapsed Time since Crash of Vital time Reading]	OF-261
Systolic Blood Pressure	OF-262
Diastolic Blood Pressure	OF-263
Respiratory Rate	OF-264

## Appendices

Appendix A

Make Model List

Appendix B

Stiffness Values

Appendix C

Child Safety Seats/Make Model

Appendix D

Table A-15 Intruded Component

Appendix E

Symbols for Crash Diagramming

**CASE FORM OVERVIEW**

The Case Form provides a basic overall view of the case. It provides a description of the crash sequence and case peculiarities (vehicle or environment). It also provides information regarding the vehicle(s) and person(s) involved in the crash.

Through this form, the researcher is able to provide the zone center, a clinical user, or any other person interested in the NASS CDS case a quick reference of the crash particulars.

The form is divided into several main tabs:

- Crash
- Structure
- Summary
- Events
- Vehicle
- Persons
- Scene

The Crash tab provides basic overview information about the case. This includes the case number and stratum, date and time of the crash, location, researcher and association to any special study.

The Structure tab provides the researcher a means of structuring the case after case assignment. All case applicable vehicles and occupants are inserted into this tab before further data entry on other forms is accomplished. In addition, this tab provides a tracking mechanism for medical records. The tab also tracks dates associated with the case.

The Summary tab provides the researcher a means for giving a textual description of the crash. The Summary should provide a non-jargon account of the crash.

The Events tab lists all harmful events associated with the crash.

The Vehicle tab lists and provides a basic description of all motor vehicles involved in the crash.

The Persons tab lists all occupants of CDS applicable vehicles found in the Vehicles tab. It provides information regarding their position within the vehicle, their restraint use and the maximum injury they suffered during the crash. In addition, it also lists the drivers of non-CDS applicable vehicles.

The Scene tab contains the scene diagram for the case. For field personnel, the tab will contain a link to the actual diagramming software file. For other personnel, the tab may only contain a JPEG representation of the final diagram.

**Required Forms and Tabs  
10 years or Newer Model Year  
Inspected**

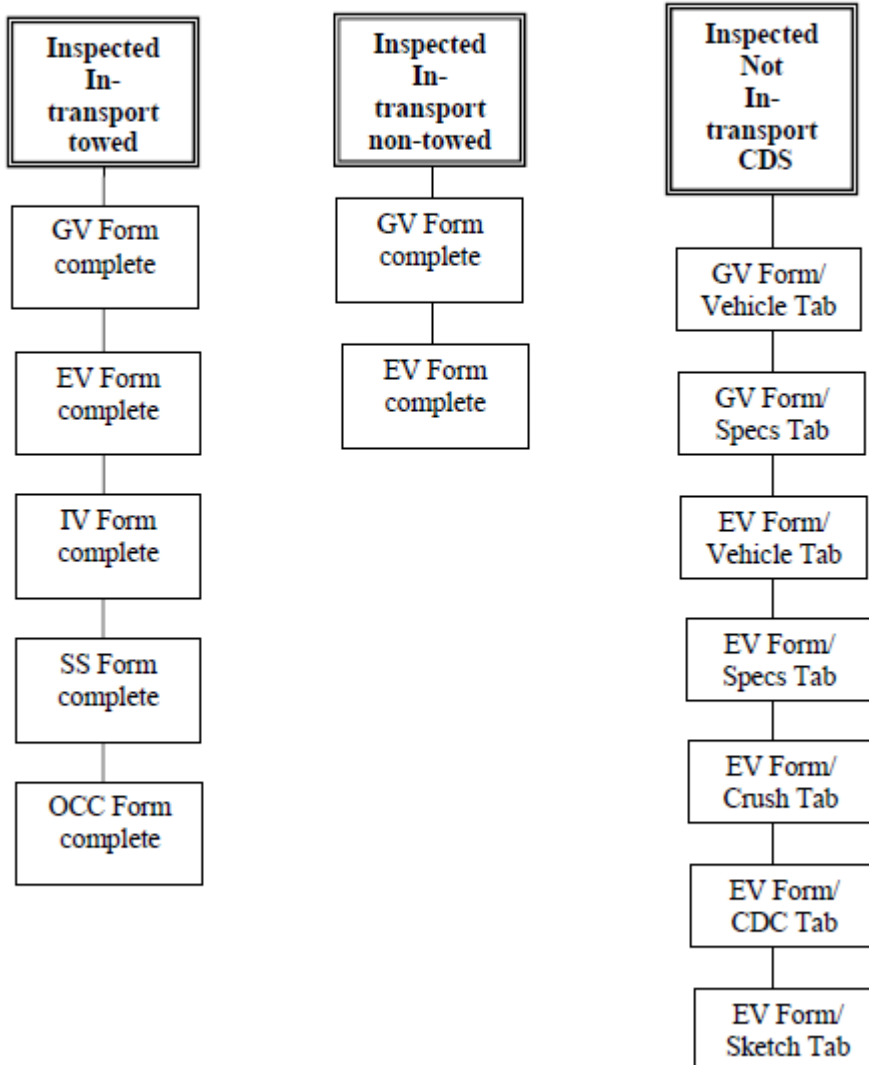

**Required Forms and Tabs  
10 years or Newer Model Year  
Not Inspected**

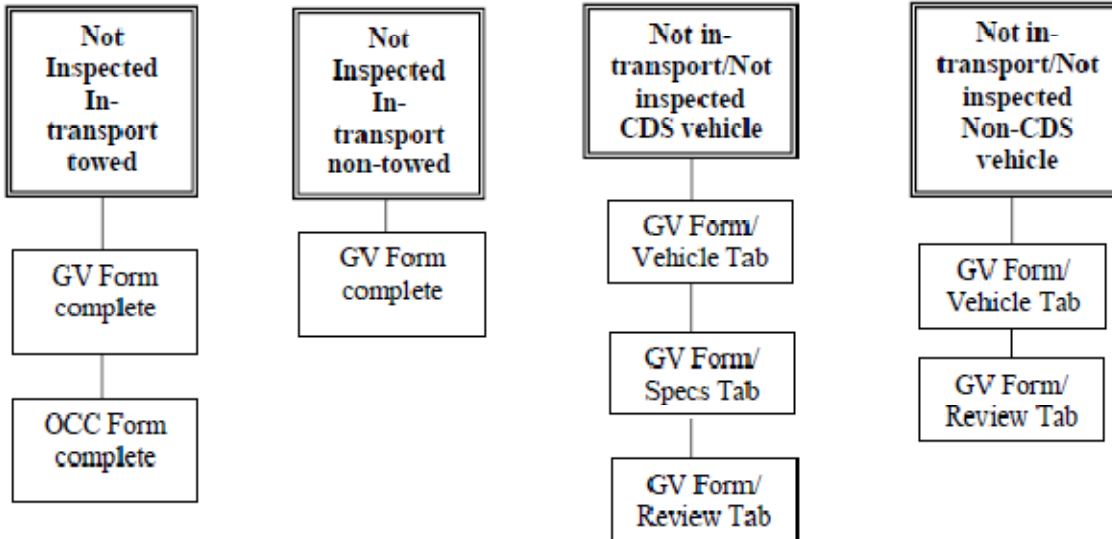

**Required Forms and Tabs  
Model Year Older Than 10 Years  
Inspected**

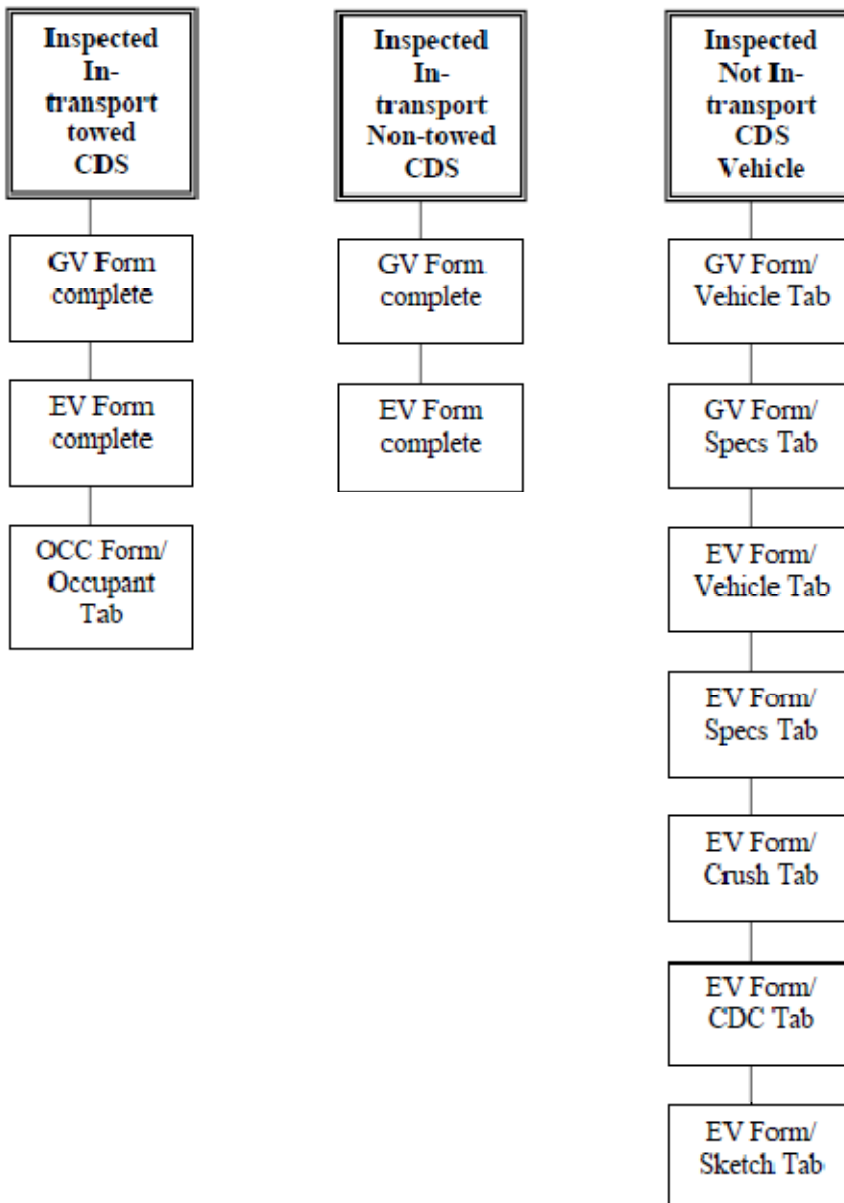

**Required Forms and Tabs  
Model Year Older Than 10 Years  
Not Inspected**

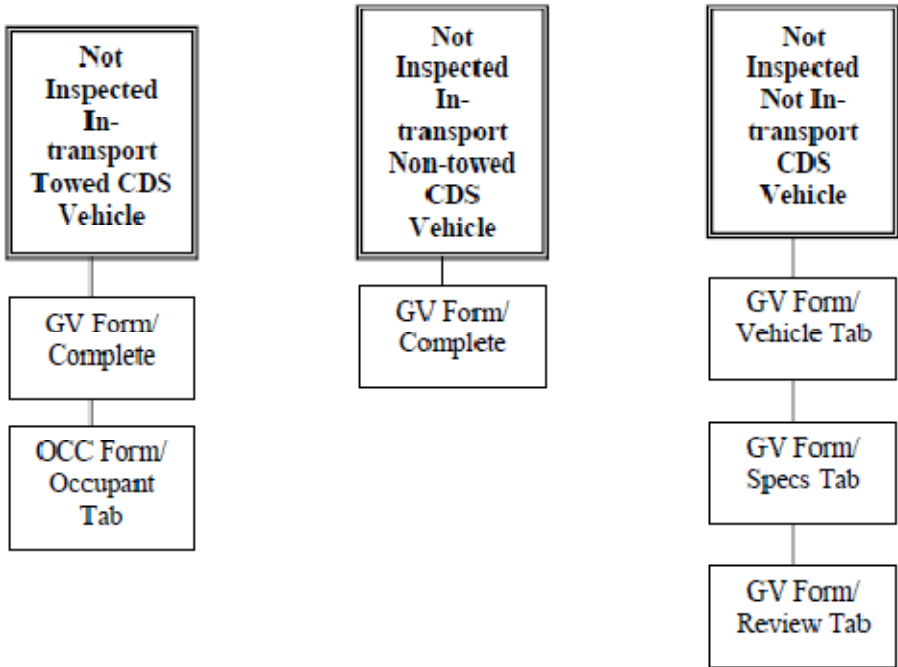

**Required Forms and Tabs  
Working Vehicles**

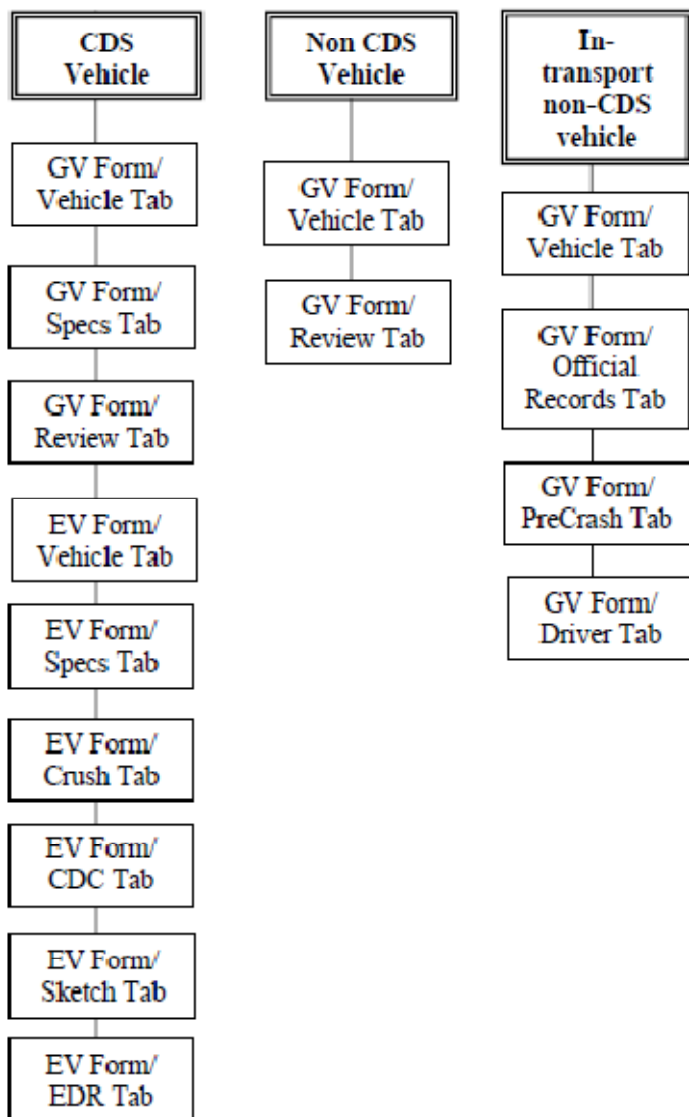



**VEHICLE FULLY REPAIRED – NO DAMAGE EVIDENT****Exterior Vehicle form** –

This protocol should be used to complete the inspection of a completely repaired vehicle. **NOTE: If damaged parts can be inspected and photographed, all applicable data should be coded - the vehicle should not be considered “fully repaired.” If images of the damaged vehicle are obtained, all applicable data should be coded - the vehicle should not be considered “fully repaired.”**

**Tires** – If it can be determined that tires have not been replaced, code data for all variables. If the tire has been replaced, code “unknown” for all variables.

**Fuel** – If it can be determined that fuel system components have not been repaired, code all variables according to the NASS protocol (i.e., if damage exists, code all variables). If damage is detected the vehicle cannot be considered “fully repaired.” If fuel system was repaired, code all variables “unknown.”

**Crush** – Code all variables “unknown,” except for Category, code as Not Applicable.

**CDC** – Code all variables “unknown” for each event.

**EDR** – Code all data if obtained from the vehicle’s original EDR module. If the module was replaced, there is no need to perform the download.

**Sketches** – Annotate all sketches “completely repaired.”

**Interior Vehicle form** –

**Integrity** – If it can be determined that no integrity-related components have been repaired or replaced, code all variables. Otherwise, code integrity and all applicable openings “unknown.”

**Glazing** – If it can be determined that no glazing has been replaced, code all variables. Otherwise, code all applicable glazing “unknown.”

**Intrusions** – Code one intrusion with “unknown” for all variables. Annotate sketch “completely repaired.”

**Instrument** – Code odometer reading and source. Indicate all adaptive equipment. Code all other variables “unknown.” If damage from occupant contact is detected, the vehicle cannot be considered “fully repaired.”

**Steering** – Code column type. Code all other variables “unknown.”

**Contact** – If contact evidence is detected, the vehicle cannot be considered “fully repaired.” Otherwise, annotate sketches “completely repaired.”

**Ejection** – Code ejection according to all known data (PAR, interview, etc). If no other data are available at the inspection, code the ejection as “unknown.”

**Entrapment** - Annotate entrapment according to all known data (PAR, interview, etc). If no other data are available at the inspection, annotate “unknown.” Check "No Entrapment."

**Safety Systems form** –

**Seat** – Define all seating positions. If it can be determined that no seat repairs have been conducted, code all variables. Otherwise, code head restraint type, seat type and orientation, integrated restraints, and air bag ever available. Code all other variables “unknown.”

**Restraints** – If it can be determined that no safety belt system repairs have been conducted, code all variables. If belt damage or deployed pretensioners are detected, the vehicle cannot be considered “fully repaired.” Otherwise, code all variables “unknown.”

**Air Bag** – If it can be determined that the airbags have not been replaced, code all variables. Otherwise, code location for each air bag. Code all other variables “unknown.”

**Child Seat** – Code all variables according to the NASS protocol (see SS-76 in CDS Manual).

CRASH

CaseForm, Case #2007-996-900015

CRASH | STRUCTURE | SUMMARY | EVENTS | SCENE | ANNOTATION | REVIEW | OTHER RESPONSE

Case Number: 90001      Status: Open

Stratum: S

Date of Crash: 1/14/2007      Sunday

Time of Crash: :

PSU: Developer PSU Server w/Oracle 9 #2

Jurisdiction:      Due Date: 02/15/2007

PAR Number: 999075985      Case ID: 999003665

Type: TEST

Researcher:      Owner:

Special Studies  
 SS15 Administrative Use

Save      Close

**CASE NUMBER**

**Screen Name:** Case Number

**SAS Data Set:** N/A

**SAS Variable:** N/A

**Oracle Name:** *NASS\_CASE.CASENUMBER*

**Element Attributes:**

**Range:** 001-499

**Source:** Assigned by Automated Case Selection System

**Remarks:**

This variable is assigned by ACSS (Automated Case Selection System) and cannot be changed.

The three digits are numbers ranging from 001 to 499. No numbers will be skipped. If a case must be dropped, the number will not be reused.

Cases sampled within the NASS CDS sampling frame are numbered 001-499. Cases selected outside of the NASS CDS sampling frame as part of a special study data collection effort are numbered outside of the normal range by the ACSS.

**STRATUM**

**Screen Name:**        **Stratum**

*SAS Data Set:*        *N/A*

*SAS Variable:*        *N/A*

*Oracle Name:*        *NASS\_CASE.STRATUM*

**Element Attributes:**

**Range:**                CDS Sampling Stratum — A, B, C, D, E, F, G, H, J, K

**Source:**                Assigned by Automated Case Selection System

**Remarks:**

This variable is generated by the ACSS (Automated Case Selection System) and cannot be changed.

The Stratum is the letter identifying which CDS sampling classification the case is assigned.

For further information refer to the NASS Sampling Manual.

**DATE OF CRASH (MONTH/DAY/YEAR)**

**Screen Name:** Date of Crash

**SAS Data Set:** *ACCIDENT*

**SAS Variable:** *MONTH, DAYWEEK, YEAR*

**Oracle Name:** *ACCIDENT.ACCIDENTDATETIME*

**Element Attributes:**

Month: 01-12  
Day: 01 through 31  
Year: Calendar year of the crash

**Source:** Rolled up from the PAR prog and Assigned by Automated Case Selection System.

**Remarks:**

This variable is assigned by the ACSS (Automated Case Selection System) and cannot be changed.

**TIME OF CRASH**

**Screen Name:** Time of Crash

**SAS Data Set:** *ACCIDENT*

**SAS Variable:** *TIME*

**Oracle Name:** *ACCIDENT.ACCIDENTTIME*

**Element Attributes:**

0000-2359

9999 Unknown

**Source:** Rolled up from the PAR prog and Assigned by Automated Case Selection System.

**Remarks:**

This variable is assigned by the ACSS (Automated Case Selection System) and cannot be changed.

**PSU**

**Screen Name:** PSU

**SAS Data Set:** *ACCIDENT*

**SAS Variable:** *PSU*

**Oracle Name:** *NASS\_CASE.ORGID*

**Element Attributes:**

PSU number

**Source:** Rolled up from the PAR prog and Assigned by Automated Case Selection System.

**Remarks:**

This variable reports the PSU (Primary Sampling Unit) that selected the case. This variable is assigned by the ACSS and cannot be changed.



**POLICE JURISDICTION**

**Screen Name:** Jurisdiction

**SAS Data Set:** N/A

**SAS Variable:** N/A

**Oracle Name:** *PARDATA.JURISDICTION*

**Element Attributes:**

PSU specific list of sampled Police Jurisdiction

**Source:** Rolled up from the PAR prog and Assigned by Automated Case Selection System.

**Remarks:**

This variable reports the sampled police jurisdiction from which the case was selected. This variable is selected in the ACSS and cannot be changed.

**PAR NUMBER**

**Screen Name:** PAR Number

**SAS Data Set:** N/A

**SAS Variable:** N/A

**Oracle Name:** *PARDATA.PARNUMBER*

**Element Attributes:**

Police report number recorded from the PAR

**Source:** Police Report

**Remarks:**

This variable reports the police report number as entered into the ACSS and cannot be changed. For further information refer to the NASS Sampling Manual.

**RESEARCHER ASSIGNED TO CASE**

**Screen Name:**            Researcher

*SAS Data Set:*        N/A

*SAS Variable:*        N/A

*Oracle Name:*        **NASS\_CASE.RESEARCHERID**

**Element Attributes:**  
                          PSU Specific

**Source:**                NASS Personnel Roster.

**Remarks:**

Select the name of the Researcher assigned the case.

**STATUS OF CASE**

Page 1 of 3

**Screen Name:** Status**SAS Data Set:** N/A**SAS Variable:** N/A**Oracle Name:** NASS\_CASE.STATUSID**Element Attributes:**

Oracle	SAS
1	New
2	Open
3	Closed
5	Released
6	Unreleased
7	Transmit
8	Copy
9	QC Review
10	Approved
11	Unapproved
12	QC Complete
13	Dropped
14	Structure
20	Published

**Source:** System Assigned.**Remarks:**

The Case Status is an indicator of a case's status within the EDS system. It is a system assigned variable which is dependent upon the creation of the case or other user actions (i.e. case release, approval, etc). Some of the attributes are program specific. A case will only be editable when it is in one of the following two statuses: New (initially) and Open.

**New**

indicates the case has been selected for research by the sampling algorithm, however it has not yet been structured.

**Open**

indicates the case is available for editing. A case can only be “Open” at one site. Usually this is a field site.

**Closed**

indicates the case has been released by the PSU and is awaiting migration of its ownership to the Zone Center. The Closed status should only appear at the PSU, no other type of site should have this type of Status associated with a case.

**Released**

indicates the case has been released by the PSU and that ownership has been transferred to the Zone Center. The Released status is unique to the PSU. No other type of site should have this type of status associated with a case.

**Unreleased**

indicates the case has been released back to the PSU for further work. The Unreleased status is unique to the Zone Center. Once a case has been unreleased, the Status will show Open at the PSU and Unreleased at the Zone Center.

**Transmit**

indicates the case ownership is currently migrating and is not yet complete. Once ownership migration is complete, the Status will change to a different status.

**Copy**

indicates the case is a static copy of a case sent from another site. Any changes made to a case by the owner of the case after being copied will not appear in the copied case until it is re-copied. All cases in a Copy status are non-editable.

**QC Review**

is a CIREN specific status which indicates the case has been copied to the CIREN QC contractor.

**Approved**

indicates that the case has been approved by the Zone Center and is no longer editable.

**Unapproved**

indicates that the case previously had the status of Approved, but the case required further update.

**QC Complete**

is a CIREN specific status which indicates the CIREN QC contractor has completed their review.

**Dropped**

indicates the case has been dropped from the study and is no longer being researched. If the case is a CDS case, it will not be included in the final analysis file. The case will not be editable once this status is assigned.

**Structure**

indicates the case is in an Open status at a lower level of the system hierarchy. For example, a NHTSA user will see a case in the Structure status until it is Approved by the Zone Center.

**Published**

indicates the case has been approved by all levels of the system and is available for public viewing.

**SPECIAL STUDIES**

**Screen Name:** Special Studies

**SAS Data Set:** *SPECSTDY*

**SAS Variable:** *STUDY*

**Oracle Name:** *SPECIALSTUDIES.STUDYID*

**Element Attributes:** Special Studies to be determined by NHTSA HQ Staff.

**Source:** Special study procedures.

**Remarks:**

A checkmark in the box adjacent to the Special Study identifier means the case qualifies for that special study.

A blank box adjacent to the Special Study identifier means the case does not qualify for this special study.

**CASE DUE DATE**

**Screen Name:** Due Date

**SAS Data Set:** N/A

**SAS Variable:** N/A

**Oracle Name:** *Derived from Sample Date + 32 days*

**Element Attributes:**

Date generated by Automated Case Selection System

**Source:** Automated Case Selection System

**Remarks:**

This variable is generated by the ACSS (Automated Case Selection System) and cannot be changed. The case due date is generally five weeks after sampling date.



**CASE IDENTIFICATION NUMBER**

**Screen Name:** Case ID

**SAS Data Set:** *ACCIDENT*

**SAS Variable:** *SCASEID*

**Oracle Name:** *NASS\_CASE.CASEID*

**Element Attributes:**

Unique Number generated by the NASSMAIN Program

**Source:** NASSMAIN Program

**Remarks:**

This variable is generated by the NASSMAIN Program and cannot be changed.

**TYPE OF CASE**

Page 1 of 2

**Screen Name:** Type**SAS Data Set:** N/A**SAS Variable:** N/A**Oracle Name:** *NASS\_CASE.CASETYPE***Element Attributes:**

Oracle	SAS
0	SCI
1	CDS
2	CIREN
3	TEST
4	TRAINING
5	SCI-CDS
9	SCI-TEST

**Source:** System Assigned – primary, Researcher - secondary.**Remarks:**

Case Type is assigned by the system during the case creation process. It may also be updated to one of the combination types (e.g. SCI-CDS, etc). The Case Type determines the structure of the case within NASSMAIN. Due to the differing structure of the different Case Types, it also affects which consistency checks will be applicable to the case.

**SCI**

is assigned to cases created thru the NASSMAIN Create – SCI Case feature. Cases assigned to this Case Type belong solely to the SCI program.

**CDS**

is assigned to cases created by the NASS CDS program. Cases assigned to this Case Type belong solely to the CDS program.

**CIREN**

is assigned to cases created thru the NASSMAIN Create – CIREN Case feature. Cases assigned to this Case Type belong solely to the SCI program.

**TEST**

is assigned to cases created thru the NASSMAIN Create – Test Case feature. Cases assigned to this case type follow the CDS structure.

**TRAINING**

is assigned to cases created thru the NASSMAIN Create – Training Case feature. Cases assigned to this case type are generally used by new CDS researchers during their training phase. These cases will follow the CDS structure.

**SCI-CDS**

is assigned to cases originally assigned to CDS, however the case is later picked up and augmented by the SCI program. This Case Type is assigned by the user ...

**SCI-TEST**

is assigned to cases created thru the NASSMAIN Create – SCI Test Case feature. These cases will follow the SCI Case Type structure.

**CASE OWNER**

**Screen Name:** Owner

**SAS Data Set:** N/A

**SAS Variable:** N/A

**Oracle Name:** *NASS\_CASE.OWNERID*

**Element Attributes:**

Selected from list of active personnel in drop down list.

**Source:** Researcher coded.

**Remarks:**

The Owner field is initially assigned to the researcher assigned to the case. As the case proceeds thru the review process, the Owner is updated to reflect the last user to have reviewed the case.

The Owner field is normally updated during the following phases of case review: peer review, zone center case review and zone center senior level review. The Owner field should reflect the individual performing the highest level of review.

The Owner field should not be updated to reflect the following types of reviews: Case Registry, Injury Coding,

---

**CASE FORM STRUCTURE OVERVIEW**

Page 1 of 2

The case form serves as the foundation of a NASS case; the structure is established and several variable selections are preset based upon data entered in the case form.

**Any time data on the case form needs to be changed all field collection forms (EV, IV, etc) must be closed before changes are made on the case form.** For instance, it may be determined from the PAR that the crash involved the frontal plane of vehicle 1; the case form would reflect a frontal impact. However, at the time of inspection, it is determined that the left plane is involved. If the EV form for vehicle 1 is already opened, the researcher will need to save then exit the form. The change can now be made on the case form and the EV form re-opened.

When the sampling procedure is complete and cases have been selected, the new cases will be listed in the NASSMAIN program. The new cases should be structured on the same day as selection: 1) to remove them from the new cases list and activate them and 2) to prepare the cases to receive data. The following is a summary to assist in structuring a case.

- Open NASSMAIN and go to “File” on the tool bar. Select “New” from the drop-down list to reveal the cases awaiting the structure process. Select the case to be structured and open it.
- The Crash tab opens first; most of the variables will be filtered in from the sampling program. Only the researcher and owner variables need to be completed. Click on the drop-down arrow and select name from the drop-down list.
- The Structure tab has several sub-tabs, but only the case, vehicle, and occupant sub-tabs need data entered to structure a case.
  - The case sub-tab has only two boxes that require data entry.
    - The scene complete box is filled in when a majority of the scene is inspected.
    - The total number of vehicles (both CDS and non-CDS) in the case is entered in the Vehicles/Total All Vehicles box. All other fields are rolled in from corresponding sub-tabs.
  - The vehicle sub-tab allows the vehicle types to be identified as CDS in transport, CDS not in transport, and non-CDS. The vehicle type assigned will determine what options are made available in the field forms.
  - The occupant sub-tab allows the number of vehicle occupants to be entered in the case. Click on “Edit” on the menu bar and select the “Insert” option. Select the vehicle number for the occupant being listed and assign an occupant number. The current protocol is to use the police assigned occupant numbers. It is important to understand that the column under **Occ #** refers to the number assigned to that occupant, not the total

- number of occupants in the vehicle. For instance, if vehicle 1 was a CDS towed vehicle and had three occupants, the form would look like this:

Veh #	Occ #	Interview Reqd
1	1	Yes
1	2	Yes
1	3	Yes

- The Events tab allows for the entry a single or multiple events that occur in a crash sequence. The events are entered in the order that they occurred by clicking on “Edit” on the menu bar and selecting the “Insert” option. An event between two vehicles should be listed with the lower numbered vehicle first. This event does not need to be listed twice, once from each vehicle’s perspective. For instance, if an event is listed with the front of vehicle 1 impacting the left of vehicle 2, it does not need to be listed again with the left of vehicle 2 impacting the front of vehicle 1.

With these steps completed, the case is structured and ready for data entry. There are other variables on the Case form that need to be completed; refer to the specific sections of the manual for assistance in their completion.

CASE

CaseForm, Case #2007-996-900015

CRASH | STRUCTURE | SUMMARY | EVENTS | SCENE | ANNOTATION | REVIEW | OTHER RESPONSE

CASE | VEHICLES | OCCUPANTS | COMMENT | DATES

Vehicles

Total All Vehicles	<input type="text" value="2"/>
CDS in Transport	<input type="text" value="2"/>
CDS not in Transport	<input type="text" value="0"/>
Non CDS in Transport	<input type="text" value="0"/>

Occupants

Total Number	<input type="text" value="2"/>
--------------	--------------------------------

Medical Records

Total Number	<input type="text"/>
--------------	----------------------

**TOTAL NUMBER OF VEHICLES IN CRASH**

Page 1 of 2

**Screen Name:** Vehicles – Total All Vehicles**SAS Data Set:** N/A**SAS Variable:** N/A**Oracle Name:** *CASESTRUCTURE.NUMOFVEHICLES***Element Attributes:**

The total number of vehicles (in-transport, CDS, and non-CDS) in the crash

**Source:** Researcher determined**Remarks:**

- Structure all vehicles that are listed on the PAR.
- Each case must have at least one in-transport and towed CDS applicable vehicle.

Vehicle information must be entered for each motor vehicle involved in the crash. For example, one CDS applicable vehicle is towing another by a nonfixed linkage (e.g., rope, chain, etc.). Assuming both vehicles are involved in the crash, data are required for both vehicles. If the linkage was fixed (see below for "fixed linkage"), only the power unit would be considered in-transport and only one form required.

When one motor vehicle is towing another, the number of vehicles depends on the crash circumstances and the type of linkage between the vehicles. A fixed linkage is defined as one which has the purpose of keeping the towed unit separated from the power unit by a distance which is essentially constant. Included within this definition are cradle linkages where the towed unit has two or more wheels off the ground. A nonfixed linkage (such as a rope or a chain) required the towed unit to be manually controlled. If the linkage between the units is fixed, consider only the vehicle that is the power (i.e., towing) unit and consider the towed unit as cargo throughout the entire crash sequence, regardless of subsequent events/impacts sustained by the towed unit. In other words, a vehicle towed by a fixed linkage:

- (1) is not considered as an in-transport vehicle,
- (2) will not have vehicle information entered, and
- (3) is considered as cargo associated with the power unit.



Total Number of Vehicles In Crash (cont'd)

Page 2 of 2

If the linkage between the units is nonfixed, each vehicle is considered in-transport, and all vehicle(s) involved in the crash sequence should be recorded individually. Hit-and-run crashes occasionally cause some confusion. Vehicle information is entered for each motor vehicle involved in the crash independent of the amount of information collected on the vehicles by the police.

**NUMBER OF CDS IN TRANSPORT VEHICLES IN CRASH**

**Screen Name:** Vehicles -- CDS in Transport

**SAS Data Set:** N/A

**SAS Variable:** N/A

**Oracle Name:** *CASESTRUCTURE.CDSTRANS*

**Element Attributes:**

The total number of CDS in Transport vehicles in the crash

**Source:** Researcher determined

**Remarks:**

The number of CDS in transport vehicles is rolled up from the Structure/Vehicles screen.

**NUMBER OF CDS NOT IN TRANSPORT VEHICLES IN CRASH**

**Screen Name:** Vehicles -- CDS not in Transport

**SAS Data Set:** N/A

**SAS Variable:** N/A

**Oracle Name:** *CASESTRUCTURE.CDSNOTRANS*

**Element Attributes:**

The total number of CDS not in Transport vehicles in the crash

**Source:** Researcher determined

**Remarks:**

The number of CDS not in transport vehicles is rolled up from the Structure/Vehicles screen.

**NUMBER OF NON CDS VEHICLES IN CRASH**

**Screen Name:** Vehicles -- Non CDS

**SAS Data Set:** N/A

**SAS Variable:** N/A

**Oracle Name:** *CASESTRUCTURE.NONCDS*

**Element Attributes:**

The total number of Non CDS vehicles in the crash

**Source:** Researcher determined

**Remarks:**

The number of non CDS vehicles is rolled up from the Structure/Vehicles screen.

**TOTAL NUMBER OF OCCUPANTS IN CDS VEHICLES IN TRANSPORT**

**Screen Name:** Occupants – Total Number of Occupants in CDS Vehicles in Transport

**SAS Data Set:** N/A

**SAS Variable:** N/A

**Oracle Name:** *CASESTRUCTURE.TOTALNUMOCCS*

**Element Attributes:**

The total number of Occupants in vehicles in the crash

**Source:** Researcher determined

**Remarks:**

This total number of occupants in vehicles is rolled up from the Structure/Occupants screen.

**TOTAL NUMBER OF MEDICAL RECORDS IN CASE**

**Screen Name:** Medical Records – Total Number

**SAS Data Set:** N/A

**SAS Variable:** N/A

**Oracle Name:** *CASESTRUCTURE.NUMMEDRECORDS*

**Element Attributes:**

The total number of Medical Records required for occupants of CDS in Transport vehicles in the crash

**Source:** Researcher determined

**Remarks:**

This total number of medical records requested or received for occupants of CDS vehicles in transport is rolled up from the Structure/Medical Records screens.

VEHICLES

CaseForm, Case #2007-996-900015

CRASH | STRUCTURE | SUMMARY | EVENTS | SCENE | ANNOTATION | REVIEW | OTHER RESPONSE

CASE | VEHICLES | OCCUPANTS | COMMENT | DATES

Veh #	Type	Inspected	Occupants	Comment
1	CDS in transport	01/14/2007	1	
2	CDS in transport		1	

Save Close

**VEHICLE NUMBER****Screen Name:** Veh #**SAS Data Set:** N/A**SAS Variable:** N/A**Oracle Name:** *CASESTRUCTUREVEHICLES.VEHICLENUMBER***Element Attributes:** As numbered**Source:** Researcher determined**Remarks:**

Each motor vehicle (regardless of body type) listed on the PAR is assigned a unique number. Vehicle numbers are to be assigned consecutively according to the order listed on the PAR.



**TYPE OF VEHICLE****Screen Name:** Type**SAS Data Set:** N/A**SAS Variable:** N/A**Oracle Name:** *CASESTRUCTUREVEHICLES.CDSTYPE***Element Attributes:**

Oracle	SAS
1	CDS in-transport
3	NON CDS
2	CDS NOT in-transport

**Source:** Researcher determined**Remarks:**

All vehicles involved in the crash must be counted. All in-transport CDS, Non CDS, and inspected not-in-transport vehicles that are struck by any CDC- applicable in-transport vehicle must be counted.

**CDS in-transport**

is used when the vehicle has been determined to be a CDS applicable vehicle that is in-transport. This is researcher determined and may not necessarily agree with the police report. For example, the PAR may list a “parked vehicle” as a struck vehicle: upon inspecting the scene the researcher determines there is no “legal” parking at the scene, so the PAR-reported parked vehicle becomes an in-transport vehicle.

**NON CDS**

is used when the vehicle is not a CDS applicable vehicle.

**CDS NOT in-transport**

is used when the inspected vehicle has been determined to be a CDS applicable vehicle that is not-in-transport. This is researcher determined and may not necessarily agree with the police report. For example, the PAR may list a “parked vehicle” as a struck vehicle: upon inspecting the scene the researcher determines there is no “legal” parking at the scene, so the PAR-reported parked vehicle becomes an in-transport vehicle.

**DATE OF VEHICLE INSPECTION**

**Screen Name:** Inspected

**SAS Data Set:** N/A

**SAS Variable:** N/A

**Oracle Name:** *VEHICLECRASH.INSPECTIONDATE*

**Element Attributes:**

Month: 01-12  
Day: 01 through 31  
Year: As appropriate

**Source:** Date is rolled up from the Vehicle Exterior Form, Vehicle screen.

**Remarks:**

Inspection date - the date the inspection was begun. This does not count unsuccessful attempts to locate the vehicle. Some data must be collected from the vehicle

The researcher enters the date on the Vehicle Exterior Form, Vehicle screen and it automatically rolls up to this variable.

**NUMBER OF OCCUPANTS IN THIS VEHICLE**

**Screen Name:** Occupants

**SAS Data Set:** N/A

**SAS Variable:** N/A

**Oracle Name:** *CASESTRUCTUREVEHICLES.NUMOFOCCUPANTS*

**Element Attributes:**

Total number of occupants in this vehicle

**Source:** The number of Occupants is rolled up from the Case Form, Structure, Occupant screen.

**Remarks:**

**CASE FORM**  
**OCCUPANTS**

**STRUCTURE/CASE**

CaseForm, Case #2007-996-900015

CRASH | STRUCTURE | SUMMARY | EVENTS | SCENE | ANNOTATION | REVIEW | OTHER RESPONSE

CASE | VEHICLES | OCCUPANTS | COMMENT | DATES

Veh #	Occ #	Interview Reqd	Completed	Reason
1	1	Yes	1/14/2007	Complete interview
2	1	Yes	1/14/2007	Partial interview

Save Close

**VEHICLE NUMBER**

**Screen Name:** Veh #

**SAS Data Set:** N/A

**SAS Variable:** N/A

**Oracle Name:** *CASESTRUCTUREVEHICLE.VEHICLENUMBER*

**Element Attributes:**

As numbered from vehicle tab

**Source:** Researcher determined

**Remarks:**

Researcher selects edit/insert from main menu. This opens a drop down list of all the vehicles entered on the Structure/Vehicles screen. The researcher then selects the vehicle number for which to enter the rest of the data.

**OCCUPANT NUMBER**

**Screen Name:** Occ #

**SAS Data Set:** N/A

**SAS Variable:** N/A

**Oracle Name:** *CASESTRUCTUREOCCUPANTS.OCCNUMBER*

**Element Attributes:**

As numbered

**Source:** Researcher determined

**Remarks:**

Researcher selects edit/insert from main menu. This opens a drop down list of all the vehicles entered on the Structure/Vehicles screen. The researcher then selects the vehicle number for which to enter the rest of the data. This automatically inserts the next available occupant number for this vehicle.

**INTERVIEW REQUIRED**

**Screen Name:** Interview Reqd

**SAS Data Set:** N/A

**SAS Variable:** N/A

**Oracle Name:** *CASESTRUCTUROCCUPANTS.INTERVIEWREQD*

**Element Attributes:**

Oracle	SAS	
1	02	Yes
0	01	No

**Source:** Researcher determined

**Remarks:**

This application automatically places a “Yes” in this variable. To change it to “No” the researcher must click on the variable box, a drop down list will appear.

**No**

is used for all occupants of non-CDS applicable vehicles that are not police-reported “towed due to damage’ or are MY greater than 10 years and non-CDS applicable vehicles.

**INTERVIEW COMPLETION DATE**

**Screen Name:** Completed

*SAS Data Set:* N/A

*SAS Variable:* N/A

*Oracle Name:*

*CASESTRUCTUREOCCUPANTS.INTERVIEWCOMPLETEDDATE*

**Element Attributes:**

Month: 01-12  
Day: 01 through 31  
Year: As appropriate

**Source:** Researcher determined

**Remarks:**

Rolled up from Occupant Form/Log/Interview



**INTERVIEW RESULTS**

**Screen Name:** Reason

**SAS Data Set:** N/A

**SAS Variable:** N/A

**Oracle Name:** *CASESTRUCTUREOCCUPANTS.INTERVIEWREASONID*

**Element Attributes:**

Oracle	SAS
1	Unable to contact or locate
2	Hit and Run
3	Fatal-surrogate not available
4	In intensive care-surrogate not available
6	Refused interview
7	Insurance company refusal
8	Attorney refusal or litigation
9	No return of questionnaire
10	Other (specify)
11	Partial interview
12	Complete interview
-8887	Not applicable

**Source:** System Assigned – primary, Researcher - secondary.

**Remarks:**

Rolled up from Occupant From/Log/Interview

MEDICAL RECORDS/SUMMARY

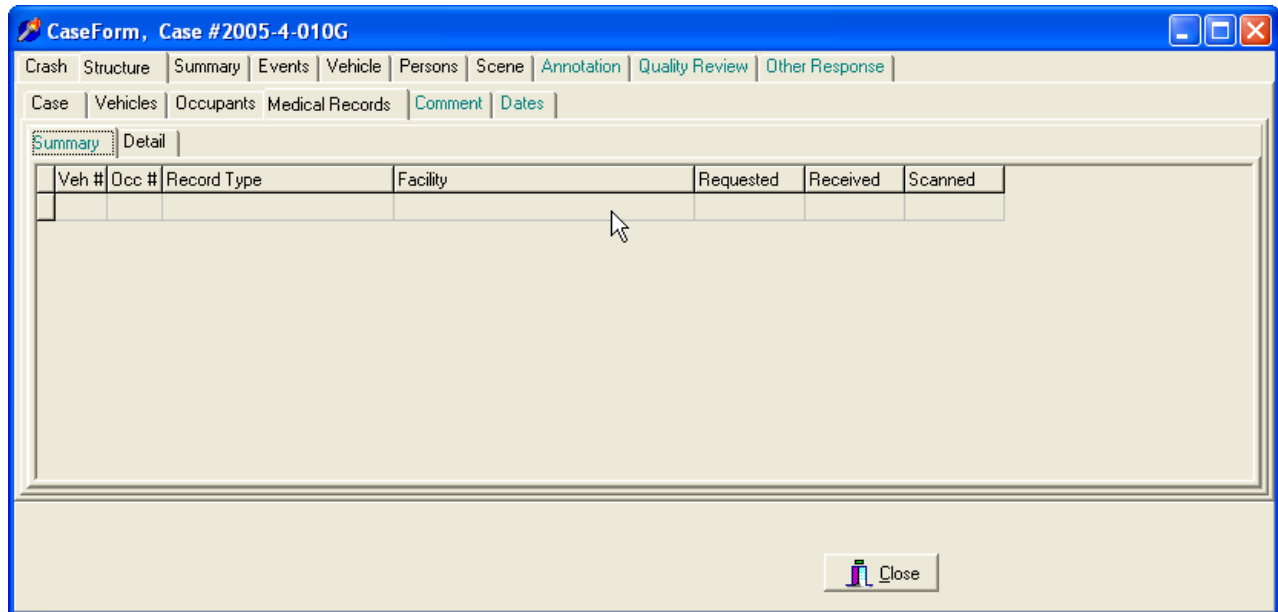

The screenshot shows a software window titled "CaseForm, Case #2005-4-010G". The window has a menu bar with options: Crash, Structure, Summary, Events, Vehicle, Persons, Scene, Annotation, Quality Review, and Other Response. Below the menu bar is a sub-menu bar with: Case, Vehicles, Occupants, Medical Records, Comment, and Dates. The "Medical Records" sub-menu is active, showing "Summary" and "Detail" tabs. The "Summary" tab is selected, displaying a table with the following columns: Veh #, Occ #, Record Type, Facility, Requested, Received, and Scanned. The table is currently empty. At the bottom right of the window is a "Close" button.

STRUCTURE/MEDICAL RECORDS/DETAIL

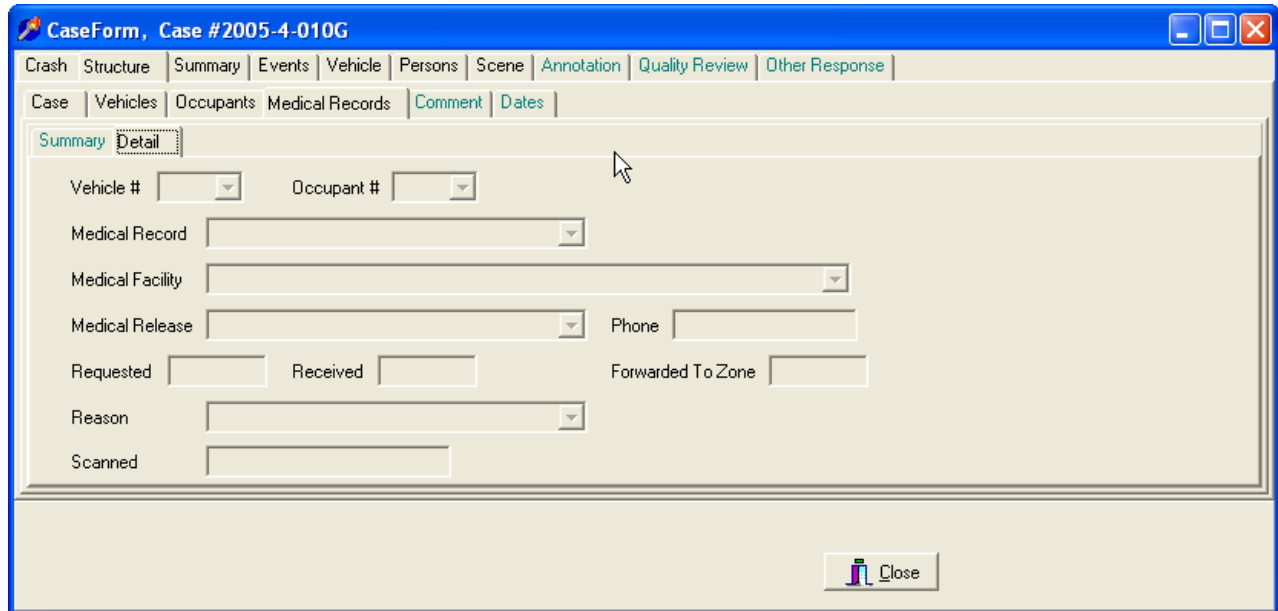

The screenshot shows the same software window as above, but with the "Detail" tab selected. The "Detail" tab contains several input fields: "Vehicle #" and "Occupant #" are dropdown menus; "Medical Record" is a dropdown menu; "Medical Facility" is a dropdown menu; "Medical Release" is a dropdown menu; "Phone" is a text input field; "Requested" and "Received" are date input fields; "Forwarded To Zone" is a text input field; "Reason" is a dropdown menu; and "Scanned" is a text input field. A "Close" button is located at the bottom right of the window.

**VEHICLE NUMBER**

**Screen Name:** Vehicle #

**SAS Data Set:** N/A

**SAS Variable:** N/A

**Oracle Name:** *CASESTRUCTUREVEHICLE.VEHICLENUMBER*

**Element Attributes:**

As numbered

**Source:** Researcher determined

**Remarks:**

Researcher selects the appropriate vehicle from the drop down list which lists a number for each CDS vehicle in the case.

**OCCUPANT NUMBER**

**Screen Name:** Occupant #

**SAS Data Set:** N/A

**SAS Variable:** N/A

**Oracle Name:** *CASESTRUCTUREOCCUPANT.OCCUPANTNUMBER*

**Element Attributes:**

As numbered

**Source:** Researcher determined

**Remarks:**

Researcher selects the appropriate occupant from the drop down list which lists a number for each occupant in the vehicle selected in the previous variable.

**MEDICAL RECORD**

Page 1 of 4

**Screen Name:** Medical Record**SAS Data Set:** N/A**SAS Variable:** N/A**Oracle Name:** *CASESTRUCTUREMEDICAL.MEDRECORDTYPE***Element Attributes:**

Oracle	SAS
16	Internal Autopsy
17	External Autopsy
18	Death Certificate
2	Post-ER Medical Record
3	Admission Records
15	Discharge Face Sheet
4	Discharge Summary
5	Operative Report
6	Radiographic
7	History/Physical Examination
8	Emergency Room records
9	Private Physician
10	Lay Coroner (Non Medical Doctor)
11	EMS Record
14	Other (specify)

**Source:** Researcher determined**Remarks:**

Researcher selects the medical record(s) from the drop down list that are needed for this occupant. If more than one type medical record is needed the researcher must select Edit/Insert for each additional record.

**Internal Autopsy**

Internal examination of a deceased individual by a licensed or official medical examiner. The examination should be a systematic review all major body regions and organs. Overall anatomical

structure and condition should be detailed in conjunction with injury detail (location and measurement) and evidence of possible pre-morbid conditions. An accurate cause of death should be documented.

**External Autopsy**

External examination of a deceased individual by a licensed or official medical examiner. The examination will consist of a visual record of the individual from general body build and features to details of visible external injury (lacerations, contusions, open fractures...). A cause of death will be determined from the examiners external findings.

**Death Certificate**

A document giving pertinent identifying information about a deceased person and certifying the manner of death.

**Post-ER Medical Record**

Medical chart documentation for an individual admitted to a hospital after initial evaluation in the Emergency Room (ER) or Trauma Resuscitation Unit (TRU). Documentation may be from physicians, nurses, therapists or other health care providers who provide services for the individual during their stay in the hospital. This documentation will cover the period of time from transfer from the ER/TRU till discharge.

**Admission Records**

Initial documentation for an individual that is admitted to a health care facility. The documentation usually includes insurance information and permissions for the admitting facility to treat the individual. Right's of the individual as they relate to their treatment and stay are outlined. The individual's admitting physician will be recorded in this document. Issues related to advance directives and living wills are often documented in these records.

**Discharge Face Sheet**

This documentation is typically only one sheet in length and identifies the individual discharged with post discharge instructions. Details on the sheet usually include dates of admission and discharge, reason for admission, diagnostic codes, medications and post discharge plans. Post discharge plans may refer to prescriptions, therapies, follow-up visits or other related issues still pending related to the individual's discharge.

**Discharge Summary**

A broad overview of an individual's hospital course for a unique admission. The summary usually contains the individual's medical doctor of record, admission and discharge dates, diagnosis's, medical history, procedures preformed, complications and discharge status. With the exception of the individual's complete chart this document typically provides the best overall review of hospital experience for an individual.

**Operative Report**

A detailed narrative of a medical procedure performed on an individual. The document should identify the medical staff performing the procedure, date and times of the procedure, reason for procedure (diagnosis) and a detailed narrative of the procedure from start to finish.

**Radiographic**

A report generated by a radiologist (M.D.) on the findings of a radiologic image or procedure. Typically, these reports are on the contents of X-rays, CAT scans or MRI's.

**History/Physical Examination (H&P)**

Documentation of an initial medical evaluation of an individual by a health care provider. The examination should contain a chief complaint (why the individual is seeking medical attention). The individual's medical history should be included and a complete physical assessment of each body section should be detailed. Basic vitals should be included and the H&P should conclude with a care plan. This includes consultations.

**Emergency Room Records**

Medical chart documentation for an individual during their stay in the Emergency Room. Documentation may be from physicians, nurses, therapists or other health care providers. Documentation should include an H&P and a disposition plan.

**Private Physician**

Documentation from a physician encounter in a private office or other non-hospital, clinic, or out-patient facility.

**Lay Coroner**

Documentation from an individual appointed by local government to assign cause of death in fatal injury cases in their jurisdiction. These individuals are usually not medical doctors and the injury/cause of death is typically derived from an external exam of the expired individual.

**EMS record**

A report from the transporting emergency team detailing an individual's health status at the crash scene and during transport to a health care facility. The report may document visible injury (lacerations) and possible injury (deformed ankle). Vital signs are generally documented as well. Details related to extrication and restraint status might be included in this record.

Medical Record (cont'd)

Page 4 of 4

**Other (specify)**

Documentation of medical or injury status not previously mentioned, this includes Death Certificates. Specify source.



**MEDICAL FACILITY**

**Screen Name:** Medical Facility

**SAS Data Set:** N/A

**SAS Variable:** N/A

**Oracle Name:** *CASESTRUCTUREMEDICAL.MEDFACILITYID*

**Element Attributes:**

Site specific

**Source:** Researcher determined

**Remarks:**

Researcher selects the appropriate medical facility from the drop down list. If more than one facility is used by this occupant, the researcher must select Edit/Insert for each additional facility.

**MEDICAL RELEASE**

**Screen Name:** Medical Release

*SAS Data Set:* N/A

*SAS Variable:* N/A

*Oraclename:* **CASESTRUCTUREMEDICAL.MEDREQUIRED**

**Element Attributes:**

Oracle	SAS
1	Not Required
2	Required-not obtained
3	Required-obtained

**Source:** Researcher determined

**Remarks:**

The researcher selects the appropriate response from the drop down list.

**DATE THAT MEDICAL RECORD WAS REQUESTED**

**Screen Name:** Requested

**SAS Data Set:** N/A

**SAS Variable:** N/A

**Oracle Name:** *CASESTRUCTUREMEDICAL.MEDREQDATE*

**Element Attributes:**

Month: 01-12  
Day: 01 through 31  
Year: As appropriate

**Source:** Researcher determined

**Remarks:**

Researcher enters the date that the medical record was requested.

**DATE THAT MEDICAL RECORD WAS RECEIVED**

**Screen Name:** Received

**SAS Data Set:** N/A

**SAS Variable:** N/A

**Oracle Name:** *CASESTRUCTUREMEDICAL.MEDRECDDATE*

**Element Attributes:**

Month: 01-12  
Day: 01 through 31  
Year: As appropriate

**Source:** Researcher determined

**Remarks:**

Researcher enters the date that the medical record was received.

**DATE THAT MEDICAL RECORD WAS FORWARDED TO THE ZONE CENTER**

**Screen Name:** Forwarded to Zone

**SAS Data Set:** N/A

**SAS Variable:** N/A

**Oracle Name:** *CASESTRUCTUREMEDICAL.MEDSENDDATE*

**Element Attributes:**

Month: 01-12  
Day: 01 through 31  
Year: As appropriate

**Source:** Researcher determined

**Remarks:**

Researcher enters the date that the medical record was forwarded to the Zone Center.

**MEDICAL RECORD OBTAINED OR REASON WHY NOT**

**Screen Name:** Reason

**SAS Data Set:** N/A

**SAS Variable:** N/A

**Oracle Name:** *CASESTRUCTUREMEDICAL.MEDREASONID*

**Element Attributes:**

Oracle	SAS
1	No record of treatment at medical facility
2	Medical release required-not obtained
4	Non-cooperative hospital
5	Hospital out-of-study area
6	Private Physician would not release data
7	Unknown if medically treated
8	Update pending
9	Record not received before file closeout
10	Record not obtained
11	Record obtained
12	Partial record obtained - no update pending
13	Partial record obtained - update pending

**Source:** Researcher determined

**Remarks:**

Researcher selects the appropriate response from the drop down list.

CASE SUMMARY

CaseForm, Case #2007-8701-009K

CRASH | STRUCTURE | SUMMARY | EVENTS | SCENE | ANNOTATION | **QUALITY REVIEW** | OTHER RESPONSE

Crash Type: Vehicle to vehicle Configuration: Head-on

Vehicles

#	Year	Make	Model	Damage Plane	Severity	FSN
▶ 1	2007	TOYOTA	CAMRY			<input type="checkbox"/>
2						<input type="checkbox"/>

Occupants

Vehicle	Role	Seat	Restraints	AIS Code	Severity	Injury Source
▶ 1	Driver	Not Defined				
1		Not Defined				
2		Not Defined				
2		Not Defined				

Save Close

**CRASH TYPE**

**Screen Name:** Crash Type

**SAS Data Set:** *ACCIDENT*

**SAS Variable:** *CRSHDSC1*

**Oracle Name:** *ACCIDENT.VEHICLETYPE*

**Element Attributes:**

Oracle	SAS	
1	01	Vehicle to vehicle
2	02	Vehicle to object(s)
3	03	Multi-vehicle
4	04	Multi-vehicle to object(s)

**Source:** Researcher determined

**Remarks:**

The researcher selects the crash type which best describes the overall crash scenario.

**Vehicle to vehicle**

is selected when the overall configuration of the crash is limited to interaction between two vehicles.

**Vehicle to object(s)**

is selected when a single vehicle is involved and has interaction with one or more fixed or non-fixed objects.

**Multi-vehicles**

is selected when there are more than two vehicles involved.

**Multi-vehicles to object(s)**

is selected when there are two or more vehicles involved **AND** there is an impact with at least one object.



**CRASH CONFIGURATION**

**Screen Name:** Configuration

**SAS Data Set:** *ACCIDENT*

**SAS Variable:** *CRSHDSC2*

**Oracle Name:** *ACCIDENT.CONFIGTYPE*

**Element Attributes:**

Oracle	SAS	
1	01	Head-on
2	02	Angle / sideswipe
3	03	Rear end
4	04	Rollover
5	05	Object off road
6	06	Object on road
7	07	Noncollision

**Source:** Researcher determined

**Remarks:**

The Researcher selects the attribute which best describes the type of collision for this crash. **The attributes are prioritized in descending order**, so if two apply, select the first one on the list. For example, two vehicles collide in an intersection at an angle, then one of the vehicles rolls over. The Researcher selects “**Angle / sideswipe**” for the configuration. This variable is used for the first vehicle listed in the first event.

**Head-on**

is selected when two vehicles impact each other, and generally the front of one vehicle contacts the front of the other vehicle.

**Angle / sideswipe**

is selected when two vehicles impact each other, and generally:

- the front of one vehicle contacts the side of the other vehicle
- OR**
- the two vehicles are involved in a “swiping” type configuration (either sideswipe or endswipe).

**Rear end**

is selected when two vehicles impact each other, and generally the front of one vehicle contacts the rear of the other vehicle.

**Rollover**

is selected for single vehicle crashes when the vehicle rolls over either on the road or off the road. For crashes involving a vehicle contacting an object off the roadway, and then rolling over, select this attribute based on the above referenced prioritization.

**Object off road**

is selected when a vehicle strikes a fixed or non-fixed object that is located off the road.

**Object on road**

is selected when a vehicle strikes a non-fixed object on the road.

**Noncollision**

is selected when the crash configuration involves some type of noncollision event (i.e., jackknife).

**CASE SUMMARY OVERVIEW**

Through the summary, the researcher is able to provide the zone center, a clinical user, or any other person interested in the NASS CDS case a quick reference of crash particulars by providing a non-jargon account of the crash.

The summary should provide a brief synopsis of the crash sequence as reconstructed by the researcher. Do not identify vehicle/driver culpability. For example, suppose vehicle #1 ran a stop sign and struck vehicle #2 in its left side. This situation should be described as follows:

*Vehicle #1 was going north and vehicle # 2 was going east on an intersecting roadway. The front of vehicle #1 impacted the right side of vehicle #2.*

Thus, the impact configuration is emphasized rather than who was at fault. Any particulars concerning vehicle crashworthiness should be highlighted. Include any abnormal crash occurrences that may be of interest to quality control or the data user. Make sure personal identifiers are not used (i.e., highway/road/street names or names of persons).

Items that are listed on the vehicle and person summary screens should not be included unless unusual circumstances are involved.

**[DATA ENTRY FIELD FOR CASE SUMMARY]**

**Screen Name:** N/A

**SAS Data Set:** ACCDESC

**SAS Variable:** LINENO

**Oracle Name:** N/A

**Element Attributes:**

The narrative summary of the crash as developed by the researcher.

**Source:** SAS generated number

**Remarks:**

**CASE SUMMARY**

**Screen Name:** Case Summary

**SAS Data Set:** *ACCDESC*

**SAS Variable:** *SUMTEXT*

**Oracle Name:** *CASESUMMARY.SUMMARY*

**Element Attributes:**

The narrative summary of the crash as developed by the researcher.

**Source:** Researcher determined

**Remarks:**

SUMMARY/VEHICLES

CaseForm, Case #2007-8701-009K

CRASH | STRUCTURE | SUMMARY | EVENTS | SCENE | ANNOTATION | **QUALITY REVIEW** | OTHER RESPONSE

Crash Type: Vehicle to vehicle Configuration: Head-on

Vehicles

#	Year	Make	Model	Damage Plane	Severity	FSN
▶ 1	2007	TOYOTA	CAMRY			<input type="checkbox"/>
2						<input type="checkbox"/>

Occupants

Vehicle	Role	Seat	Restraints	AIS Code	Severity	Injury Source
▶ 1	Driver	Not Defined				
1		Not Defined				
2		Not Defined				
2		Not Defined				

Save Close

**VEHICLE NUMBER****Screen Name:** #**SAS Data Set:** N/A**SAS Variable:** N/A**Oracle Name:** *VEHICLE.VEHICLENUMBER***Element Attributes:****Source:** Rolled up from Case Structure/Vehicle Tab.**Remarks:**

The vehicle number of each in-transport vehicle and inspected not in-transport vehicle in the crash is indicated.

**VEHICLE YEAR**

**Screen Name:** Year

**SAS Data Set:** *ACCIDENT*

**SAS Variable:** *YEAR*

**Oracle Name:** *VEHICLE.MODELYEAR*

**Element Attributes:**

**Source:** Rolled up from General Vehicle form/Vehicle Tab.

**Remarks:**

Refer to the General Vehicle form/Model Year.



**VEHICLE MAKE**

**Screen Name:** Make

**SAS Data Set:** N/A

**SAS Variable:** N/A

**Oracle Name:** *VEHICLE.MAKEID*

**Element Attributes:**

**Source:** Rolled up from General Vehicle form/Vehicle Tab.

**Remarks:**

Refer to the General Vehicle form/Make.

**VEHICLE MODEL**

**Screen Name:** Model

**SAS Data Set:** N/A

**SAS Variable:** N/A

**Oracle Name:** *VEHICLE.MODELID*

**Element Attributes:**

**Source:** Rolled up from General Vehicle form/Vehicle Tab.

**Remarks:**

Refer to the General Vehicle form/Model.

**DAMAGE PLANE**

**Screen Name:** Damage Plane

**SAS Data Set:** N/A

**SAS Variable:** N/A

**Oracle Name:** *VEHICLE.DAMAGEPLANE*

**Element Attributes:**

Oracle	SAS	
1	1	Front
2	2	Left
3	3	Right
4	4	Back
5	5	Top
6	6	Undercarriage
-99	99	Unknown

**Source:** Researcher determined

**Remarks:**

The Researcher must determine the most severe impact and choose the associated damage plane.

All efforts should be made to determine the plane of damage. The vehicle inspection, occupant interview, police report, tow yard operator, damage to other vehicles or objects should be considered.

If there is absolutely no information available, then "Unknown" may be used. However, it should rarely be selected.

**DAMAGE SEVERITY**

**Screen Name:** Severity

**SAS Data Set:** N/A

**SAS Variable:** N/A

**Oracle Name:** *VEHICLE.SEVERITY*

**Element Attributes:**

Oracle	SAS	
1	1	Light
2	2	Moderate
3	3	Severe
9	9	Unknown

**Source:** Rolled up from General Vehicle form/Delta V tab.

**Remarks:**

**Unknown**  
is used if no vehicle inspection is completed.

**COMPONENT MALFUNCTION**

Page 1 of 3

**Screen Name:** FSN**SAS Data Set:** N/A**SAS Variable:** N/A**Oracle Name:** *Derived from entry on Field Safety Notification***Element Attributes:****Source:** Field Safety Notification**Remarks:**

This is not editable by the researcher. If a Field Safety Notification form has been completed by the researcher this field will indicate the presence of it attached to this case.

Any vehicular component that malfunctioned during the crash sequence should be noted. The components of special interest to the user may be noted by reviewing the field form variables (*e.g.*, steering columns, seat backs, restraints, glazing, etc.).

Below is an additional list of special interest component malfunction crashes:

The researcher should complete a Field Safety Notification (FSN) Form if any of the below described specific areas of interest are observed.

**SPECIFIC AREAS OF INTEREST TO NHTSA RULE MAKING****CRASH AVOIDANCE**

1. Crashes involving vehicles being operated or equipped with adaptive equipment.
2. Crashes in which malfunctions of a multi-piece rim (not a tire malfunction) caused or contributed to the severity of the crash.
3. Crashes involving malfunction of a speed governor or speed control unit.
4. Crashes where the driver reported confusion about the location of display or control elements of the vehicle.
5. Crashes where under inflation of tires caused or contributed to the severity of crash.

6. Crashes involving pedestrian and/or cyclist injured by impact with outside mirrors.
7. Crashes where commercial vehicle drivers reported that they could not see car, pedestrian, or cycle in a specific blind spot (such as in the right front area of large truck-tractors).
8. Crashes where a driver of a passenger car or light truck reported that they could not see because of an obstruction of view by some part of the vehicle (such as inside mirror or roof support pillar).
9. Rollover crashes with vehicles equipped with electronic stability control
10. Crashes involving pickup trucks pulling fifth-wheel type trailer.
11. Crashes involving stalled vehicles.

**CRASHWORTHINESS**

1. Seat and/or seat back separations/malfunctions in crashes and their contributions to occupant injury.
2. Identify external vehicle components (i.e., hood, grill, windshield wiper, etc.) that penetrate the windshield and the degree of such penetration in crashes involving vans and light trucks.
3. Ejections through the hatchback or station wagon rear doors in rear impacts. Identify whether ejection was through window opening or through door or hatchback opening because of latch malfunction.
4. Cars involving child restraints that fracture or involve injury. Identify and document the restraint by make, model, and seat position.

**Examples of defects considered safety-related:**

- Steering components that break suddenly causing partial or complete loss of vehicle control.
- Problems with fuel system components, particularly in their susceptibility to crash damage, that result in leakage of fuel and possibly cause vehicle fires.
- Accelerator controls that may break or stick.
- Wheels that crack or break, resulting in loss of vehicle control.
- Windshield wiper assemblies that fail to operate properly.
- Seats and/or seat backs that malfunction unexpectedly during normal use.

- Critical vehicle components that break, fall apart, or separate from the vehicle, causing potential loss of vehicle control or injury to persons inside or outside the vehicle.
- Wiring system problems that result in a fire or loss of lighting.
- Air bags that deploy under conditions for which they are not intended to deploy.
- Child safety seats that contain malfunctioning safety belts, buckles, or components that create a risk of injury, not only in a vehicle crash but also in non-operational safety of a motor vehicle.

**Examples of defects NOT considered safety-related:**

- Air conditioners and radios that do not operate properly.
- Ordinary wear of equipment that has to be inspected, maintained and replaced periodically. Such equipment includes shock absorbers, batteries, brake pads and shoes, and exhaust systems.
- Nonstructural or body panel rust.
- Quality of paint or cosmetic blemishes.
- Excessive oil consumption.

SUMMARY/OCCUPANTS

CaseForm, Case #2007-8701-009K

CRASH | STRUCTURE | SUMMARY | EVENTS | SCENE | ANNOTATION | **QUALITY REVIEW** | OTHER RESPONSE

Crash Type: Vehicle to vehicle Configuration: Head-on

Vehicles

#	Year	Make	Model	Damage Plane	Severity	FSN
▶ 1	2007	TOYOTA	CAMRY			<input type="checkbox"/>
2						<input type="checkbox"/>

Occupants

Vehicle	Role	Seat	Restraints	AIS Code	Severity	Injury Source
▶	1 Driver	Not Defined				
	1	Not Defined				
	2	Not Defined				
	2	Not Defined				

Save Close



**VEHICLE NUMBER**

**Screen Name:** Vehicle

**SAS Data Set:** N/A

**SAS Variable:** N/A

**Oracle Name:** ***VEHICLE.VEHICLENUMBER***

**Element Attributes:**

**Range:** Numeric value

**Source:** Rolled up from General Vehicle form.

**Remarks:**

The identifying number for each vehicle, of an in-transport CDS vehicle involved in the crash is indicated here.

**PERSON ROLE**

**Screen Name:** Role

**SAS Data Set:** N/A

**SAS Variable:** N/A

**Oracle Name:** *OCCUPANT.PICKROLE*

**Element Attributes:**

Oracle	SAS	
1	1	Driver
2	2	Passenger
9	9	Unknown

**Source:** Rolled up from Occupant form.

**Remarks:**

Person Role indicates if the person was the *driver* or a *passenger*, or **unknown**.

**SEAT POSITION**

**Screen Name:** Seat

**SAS Data Set:** N/A

**SAS Variable:** N/A

**Oracle Name:** *SEATLOC.SEATROW/SEATLOC.SEATLOCATION*

**Element Attributes:****Range:**

**Source:** Rolled up from Occupant form

**Remarks:**

The seat position of each person in the vehicle is indicated here. Seat position is indicated as "front left", "second middle", etc.

**RESTRAINTS USE**

**Screen Name:** Restraints

**SAS Data Set:** N/A

**SAS Variable:** N/A

**Oracle Name:** *DERIVED FROM OCCUPANT FORM RESTRAINT ENTRY*

**Element Attributes:****Range:**

**Source:** Rolled up from Occupant form.

**Remarks:**

The type of restraint "used" by the person during the crash (e.g., combinations of manual belts, automatic belts, air bags, and/or child seats) is indicated.

**AIS CODE**

**Screen Name:** AIS Code

**SAS Data Set:** N/A

**SAS Variable:** N/A

**Oracle Name:** *INJURY.AISCODES*

**Element Attributes:**

**Source:** Rolled up from Occupant form.

**Remarks:**

The most severe (*i.e.*, highest AIS) injury to the person is indicated by the seven digit AIS90 code.

**INJURY SEVERITY**

**Screen Name:** Severity

**SAS Data Set:** N/A

**SAS Variable:** N/A

**Oracle Name:** ***DERIVED FROM THE MAXIMUM AIS SEVERITY***

**Element Attributes:**

**Source:** Rolled up from Occupant form.

**Remarks:**

The most severe (*i.e.*, highest AIS) injury to the person is indicated as minor, moderate, serious, severe, critical, maximum, or injured unknown severity.

**INJURY SOURCE**

**Screen Name:** Injury Source

**SAS Data Set:** N/A

**SAS Variable:** N/A

**Oracle Name:** *INJURY.PICKINJURYSOURCE*

**Element Attributes:**

**Source:** Rolled up from Occupant form.

**Remarks:**

The source of the most severe (*i.e.*, highest AIS) injury to the person is indicated.

EVENTS/SUMMARY

The screenshot shows a software window titled "CaseForm, Case #2007-996-900015". The window has a menu bar with options: CRASH, STRUCTURE, SUMMARY, EVENTS, SCENE, ANNOTATION, REVIEW, and OTHER RESPONSE. Below the menu bar, there are two tabs: "SUMMARY" (selected) and "DETAIL". The main area contains a table with the following data:

Event	Veh #	Area of Damage	Contacted	Class	Area of Damage
▶ 1	2	Front	Vehicle#1	Intermediate (wheelbase >= 2	Front
2	1	Top	Overturn->rollover(excludes end-	Not a motor vehicle	Noncollision

At the bottom right of the window, there are two buttons: "Save" (with a green checkmark icon) and "Close" (with a red X icon).

Information rolls up from the “detail” tab to the “summary” tab. Use the arrow to the left of the event to highlight an event to focus on the “Detail” screen.

**Note: If impact is between two vehicles, double click on the event line to view the vehicle angles, accident types, and CDC for this event.**



EVENTS/DETAIL

CaseForm, Case #2007-8701-009K

CRASH | STRUCTURE | SUMMARY | EVENTS | SCENE | ANNOTATION | **QUALITY REVIEW** | OTHER RESPONSE

SUMMARY | **DETAIL**

Event No  of 2 Previous Next

Vehicle No  Class of Vehicle   
General Area of Damage

VERSUS

Object Contacted    
Class of Vehicle   
General Area of Damage

**CRASH EVENTS OVERVIEW**

Page 1 of 2

A "crash" is the total set of "events" (one or more) that results from an unstabilized situation such that at least one harmful event occurs not directly resulting from a cataclysm. The "crash" is concluded in time when all events which originated from the unstabilized situation have stabilized.

A crash is considered applicable to the NASS CDS if one of its events resulted in harm (except for nonqualifying noncollision events); and that event involved an in-transport CDS applicable vehicle which was reported on a police report as being towed from the scene of the crash due to damage.

Harm can be either an impact or a noncollision event. An impact is defined as any vehicle-to-vehicle or vehicle to object (fixed or nonfixed, stationary or nonstationary) contact which may or may not result in vehicle damage, injury or property damage. Noncollision events such as fire/explosion, occupant fell from vehicle, occupant injury without vehicle impact, etc., are included in these variables unless this noncollision event is the only event in the case.

Below are some examples of nonqualifying events and the researcher should not include them in the crash sequence.

Exclude events such as:

Not in-transport vehicle impacts pedestrian, pedalcyclist, or other nonmotorist.

Not in-transport vehicle impacts an object (fixed or nonfixed).

Pedestrian (pedalcyclist, other nonmotorist) impacts an object.

Pedestrian (pedalcyclist, other nonmotorist) impacts a not in-transport vehicle.

Pedestrian, pedalcyclist, or other nonmotorist inter-impact.

The crash events variables are designed to provide a description of all qualifying events which occurred in the crash sequence. Events are listed in chronological sequence. In events involving impacts with objects, the object is identified subsequent to the vehicle. Code events as they occur during the crash sequence.

With this chronological sequence of qualified crash events in the CDS database, analysts can review the entire series of events involving motor vehicles. Various areas of concern to

the highway safety community will be easily assessed using these variables. For instance, the injury severity in crashes can be assessed relative to the number and type of impacts involved.

Likewise, certain collision configurations may create a greater hazardous condition for the occupants. A possible area of analysis would be the mix of vehicle classes or the type(s) of object(s) the vehicles impact.

Complete these variables based upon an accurate and complete reconstruction of the vehicle dynamics involved in the crash.

An example of a crash sequence follows:

Vehicle 1 (a compact passenger car) went out of control on a wet roadway and struck a median guardrail with its front {Event 1}. The vehicle was redirected by the guardrail and reentered the roadway, where it struck vehicle 2 (a large pickup truck) {Event 2} in the left side with its front. Vehicle 1 spun to a stop in the roadway. During event 2 the driver hit his head on the door pillar breaking his neck {not a coded event}. Vehicle 2, out-of-control, ran off the roadway and struck a pedestrian with its front {Event 3}.

Note: For the driver of vehicle 1, breaking his neck is not a separate codeable event. Rather, this injury, and almost all occupant injuries resulting from occupant interior contact, is a result of a collision event.

A vehicle is considered as being a rollover if it rotates at least 90 degrees.

**EVENT NUMBER**

**Screen Name:** Event No

**SAS Data Set:** *EVENT*

**SAS Variable:** *ACCSEQ*

**Oracle Name:** *EVENTS.EVENTSEQUENCENUMBER*

**Element Attributes:**

As assigned

**Source:** Researcher Determined

**Remarks:**

The researcher selects edit/insert from the main menu, this opens a new detail tab for each event. This number is automatically assigned by the application as each event is entered. Events may be renumbered on associated Summary Tab. This will cause the events to be re-numbered, the researcher must ensure the events are in proper order. The events will be displayed in chronological sequence.

**VEHICLE NUMBER**

**Screen Name:** Vehicle

**SAS Data Set:** *EVENT*

**SAS Variable:** *VEHNUM*

**Oracle Name:** *EVENTS.VEHICLEID*

**Element Attributes:**

As entered into Case Form/Structure/Case Summary/Total All Vehicles

**Source:** Researcher determined by selecting the vehicle from the drop down list.

**Remarks:**

Vehicle numbers must be consecutive beginning with "1". Vehicle numbers are rolled up from those listed in the vehicle tab. A vehicle may be listed in more than one event.

**[CLASS OF VEHICLE]**

Page 1 of 5

**Screen Name:** Class of Vehicle**SAS Data Set:** *EVENT***SAS Variable:** *CLASS1***Oracle Name:** *VEHICLE.PICKVEHICLECLASS***Element Attributes:**

Oracle	SAS	
0	0	Not a motor vehicle
1	1	Subcompact/mini ( wheelbase < 254 cm)
2	2	Compact (wheelbase ≥ 254 but < 265 cm)
3	3	Intermediate (wheelbase ≥ 265 but < 278 cm)
4	4	Full size ( wheelbase ≥ 278 but < 291 cm)
5	5	Largest (wheelbase ≥ 291 cm)
9	9	Unknown passenger car size
14	14	Compact utility vehicle
15	15	Large utility vehicle (≤ 4,536 kgs GVWR)
16	16	Utility station wagon (≤ 4,536 kgs GVWR)
19	19	Unknown utility type
20	20	Minivan (≤ 4,536 kgs GVWR)
21	21	Large van (≤ 4,536 kgs GVWR)
24	24	Van based school bus ( ≤ 4,536 kgs GVWR)
28	28	Other van type (≤ 4,536 kgs GVWR)
29	29	Unknown van type ( ≤ 4,536 kgs GVWR)
30	30	Compact pickup truck (≤ 4,536 kgs GVWR)
31	31	Large pickup truck (≤ 4,536 kgs GVWR)
38	38	Other pickup truck (≤ 4,536 kgs GVWR)
39	39	Unknown pickup truck type ( ≤ 4,536 kgs GVWR)
45	45	Other light truck (≤ 4,536 kgs GVWR)
48	48	Unknown light truck type ( ≤ 4,536 kgs GVWR)
49	49	Unknown light vehicle type
50	50	School bus (excludes van based) (> 4,536 kgs GVWR)
58	58	Other bus (> 4,536 kgs GVWR)
59	59	Unknown bus type
60	60	Truck (> 4,536 kgs GVWR)
67	67	Tractor without trailer

Class of Vehicle (cont'd)

Oracle	SAS	
68	68	Tractor - trailer(s)
78	78	Unknown medium/heavy truck type
79	79	Unknown light/medium/heavy truck type
80	80	Motored cycle
90	90	Other vehicle
99	99	Unknown

**Source:** This variable is derived from application inputs from the GV form/Vehicle and Specifications Tab

**Remarks:**

The Passenger Car Classification Subcommittee, A3B11(1), of the Transportation Research Board, Traffic Records and Accident Analysis Committee, A3B11, assessed size based on the vehicle wheelbase. The guidelines for this classification can be found in the report entitled Recommended Definitions for Passenger Car Size Classification by Wheelbase and Weight, August 1984 by the previously mentioned subcommittee. This variable is the same variable that appears in the Identification section of the Vehicle Tab on the General Vehicle Form and Vehicle Exterior Form.

**Subcompact/mini (wheelbase < 254 cm)**

Choose based upon wheelbase

**Compact (wheelbase >= 254 but < 265 cm)**

Choose based upon wheelbase

**Intermediate (wheelbase >= 265 but < 278 cm)**

Choose based upon wheelbase

**Full size (wheelbase >= 278 but < 291 cm)**

Choose based upon wheelbase

**Largest (wheelbase >= 291 cm)**

Choose based upon wheelbase

**Unknown passenger car size**

is used when it is known that a vehicle is a passenger car but the wheelbase is unknown

**Compact utility vehicle**

refers to vehicle models defined as **Compact utility** under Body Type. Use this attribute if the size of the utility vehicle is unknown.

**Large utility vehicle (<= 4,536 kgs GVWR)**

refers to vehicle models defined as **Large utility** under Body Type. Refers to full-size multipurpose vehicles primarily designed around a shortened pickup truck chassis. While generally a station wagon body style, some models are equipped with a removable top.

**Utility station wagon (<= 4,536 kgs GVWR)**

refers to vehicle models defined as **Utility station wagon** under Body Type. Refers primarily to a pickup truck based chassis enlarged to a station wagon.

**Unknown Utility type**

is defined as **Utility, unknown body type** under Body Type. This attribute is used when it is known that the vehicle is a utility vehicle, but there is insufficient data to determine the specific type.

**Minivan (<= 4536 kgs. GVWR)**

Refers to vehicle models defined as **Minivan** under Body Type. Refers to down-sized passenger or cargo vans.

**Large van (<= 4536 kgs. GVWR)**

Refers vehicle models defined as **Large van** under Body Type. Refers to a standard size cargo or passenger van.

**Van based school bus (<= 4,536 kgs GVWR)**

is a passenger van designed to carry students (passengers) to and from educational facilities and/or related functions. The vehicles are characteristically painted yellow and clearly identified as school buses. Use this attribute regardless of whether the vehicle is owned by a school system or a private company. Van based school buses converted for other uses (e.g., church bus) also take this attribute. Refers to vehicles defined as **Van based school bus** under Body Type.

**Other van type (<= 4,536 kgs GVWR)**

Refers to vehicle models defined as **Step van or walk-in van, Van based motorhome, Van based other bus and code Other van type** under Body Type.

**Unknown van type (<= 4,536 kgs GVWR)**

is used when it is known that this vehicle is a light van, but its specific type cannot be determined. Refers to vehicles described as **Unknown van type** under Body Type.

**Compact pickup truck**

Refers to vehicle models defined as attributes of **Compact pickup truck** in Body Type. Used to describe a pickup truck having a width of 178 centimeters or less.

**Large pickup truck**

Refers to vehicle models defined as **Large pickup truck** under Body Type. Used to describe a pickup truck having a width greater than 178 centimeters.



**Other pickup truck (<= 4536 kgs GVWR)**

Refers to vehicle models defined as **Pickup with slide-in camper** and **Convertible pickup** under Body Type.

**Unknown pickup truck (<= 4536 kgs GVWR)**

Refers to vehicle models defined as **Unknown pickup style light conventional truck type** under Body Type.

**Other light truck (<= 4536 kgs GVWR)**

Refers to vehicle models defined as **Cab, chassis based (includes rescue vehicles, light stake, dump, and tow truck)**, **Truck based panel**, **Light truck based motorhome (chassis mounted)**, and **Other light conventional truck type** under Body Type.

**Unknown light truck type**

Refers to vehicle models defined as **Unknown light truck type** under Body Type.

**Unknown light vehicle type (automobile, utility, van, or light truck)**

Refers to vehicle models defined as **Unknown light vehicle type (automobile, utility, van, or light truck)** under Body Type.

**School bus (excludes van based) (> 4536 kgs GVWR)**

Refers to those vehicle models defined as **School bus (designed to carry students, not cross country or transit)** under Body Type.

**Other bus (>4,536 kgs GVWR)**

describes those vehicle models included in **Other bus type (e.g., transit, intercity, bus based motorhome)** under Body Type.

**Unknown bus type**

Refers to those vehicle models described as **Unknown bus type** under Body Type.

**Truck (> 4,536 kgs GVWR)**

is defined under Body Type, as **Step van (>4,536 kgs GVWR)**, **Single unit straight truck (4,536 kgs < GVWR = 8,845)**, **Single unit straight truck (8,845 kgs < GVWR = 11,793)**, **Single unit straight truck (>11,793 kgs GVWR)**, **Single unit straight truck, GVWR unknown** and **Medium/heavy truck based motorhome**.

**Tractor without trailer**

refers to **Truck-tractor with no cargo trailer** under Body Type.

**Tractor-trailer(s)**

is defined in attributes **Truck-tractor pulling one trailer**, **Truck-tractor pulling two or more trailers** and **Truck-tractor (unknown if pulling trailer)** under Body Type.

**Unknown medium/heavy truck type)**

is used when the only available information indicates a truck of medium/heavy size. Refer to **Unknown medium/heavy truck type** under Body Type.

**Unknown truck type (light/medium/heavy)**

Refers to those vehicles described by **Unknown truck type (light/medium/heavy)** under Body Type.

**Motored cycle**

refers to Body Type, **Motorcycle, Moped (motorized bicycle), Three-wheel motorcycle or moped, Other motored cycle (minibike, motorscooter)** and **Unknown motored cycle type**.

**Other vehicle**

refers to all vehicles described by **ATV (All-Terrain Vehicle) and ATC (All-Terrain Cycle), Snowmobile, Farm equipment other than trucks, or Other vehicle type** under Body Type.

**Unknown**

is used when there is a lack of information regarding the type of vehicle. This lack of information prohibits the accurate classification of this vehicle using one of the preceding codes. This attribute is equivalent to Body Type, **Unknown body type**.

**GENERAL AREA OF DAMAGE**

**Screen Name:** General Area of Damage

**SAS Data Set:** *EVENT*

**SAS Variable:** *GADEVI*

**Oracle Name:** *EVENTS.PICKAREAOFDAMAGE*

**Element Attributes:**

Oracle	SAS	
0	1/10	Not a motor vehicle
N	2/11	Noncollision
9	21/9	Unknown

**CDC Applicable and Other Vehicles**

Oracle	SAS	
F	3	Front
R	4	Right side
L	5	Left side
B	6	Back of unit with cargo area
T	7	Top
U	8	Undercarriage

**TDC Applicable Vehicles**

Oracle	SAS	
F	12	Front
R	13	Right side
L	14	Left side
B	15	Back of unit with cargo area (rear of trailer or straight truck)
D	16	Back (rear of tractor)
C	17	Rear of cab
V	18	Front of cargo area
T	19	Top
U	20	Undercarriage

**Source:** Researcher determined.

General Area of Damage (cont'd)

Page 2 of 2

**Remarks:****Noncollision**

must be used whenever the corresponding Vehicle Number or Object Contacted Category is coded Noncollision.

**Unknown**

must be coded when the General Area of Damage - on a vehicle is not known from any reliable source.

For vehicles which are CDC applicable (e.g., pickups, light vans, and passenger cars) the guidelines from J224MAR80 must be applied, and the attributes provided under the "CDC Applicable and Other Vehicles" category must be used. This includes rollovers.

For vehicles which are TDC applicable (i.e., medium/heavy trucks) use the guidelines and the attributes provided under the "TDC Applicable Vehicles" category.

**OBJECT CONTACTED**

**Screen Name:** Object Contacted

**SAS Data Set:** *EVENT*

**SAS Variable:** *OBJCONT*

**Oracle Name:** *EVENTS.PICKOBJECTCONTACT*

**Element Attributes:**

Oracle/SAS

01-30 Vehicle Number

**Noncollision**

- 31 Overturn — rollover (excludes end-over-end)
- 32 Rollover - end-over-end
- 33 Fire or explosion
- 34 Jackknife
- 35 Other intraunit damage (specify):
- 36 Noncollision injury
- 38 Other noncollision (specify):
- 39 Noncollision — details unknown

**Collision With Fixed Object**

- 41 Tree (≤ 10 cm in diameter)
- 42 Tree (> 10 cm in diameter)
- 43 Shrubbery or bush
- 44 Embankment
- 45 Breakaway pole or post (any diameter)
- 50 Nonbreakaway Pole or post (≤ 10 cm in diameter)
- 51 Nonbreakaway Pole or post (> 10 cm but ≤ 30 cm in diameter)
- 52 Nonbreakaway Pole or post (> 30 cm in diameter)
- 53 Nonbreakaway Pole or post (diameter unknown)
- 54 Concrete traffic barrier
- 55 Impact attenuator
- 56 Other traffic barrier (specify):
- 57 Fence
- 58 Wall

Oracle/SAS

- 59 Building
- 60 Ditch or culvert
- 61 Ground
- 62 Fire hydrant
- 63 Curb
- 64 Bridge
- 68 Other fixed object (specify):
- 69 Unknown fixed object
- Cable barrier guardrail
- 48 Guardrail Face
- 49 Guardrail End

**Collision with Nonfixed Object**

- 72 Pedestrian
- 73 Cyclist or cycle
- 74 Other nonmotorist or conveyance (specify)
- 75 Vehicle occupant
- 76 Animal
- 102 77 Railway vehicle
- 78 Trailer, disconnected in transport
- 79 Object fell from vehicle in-transport
- 88 Other nonfixed object (specify):
- 89 Unknown nonfixed object

**Other event (specify)**

- 98 Other event (specify):

**Unknown event or object**

- 99 Unknown event or object

Object Contacted (cont'd)

Page 2 of 10

**Source:** Researcher determined. Primary sources are the scene and vehicle inspections; secondary sources include the police report and interviewees.

**Remarks:****Vehicle Number**

If the object contacted by the vehicle under consideration was a motor vehicle, select the Vehicle Number assigned to that vehicle.

**Noncollision**

Crash circumstances, which result in nonimpact related damage or harm.

**Overturn — rollover (excludes end-over-end)**

is used whenever a vehicle rolls over or overturns primarily about the longitudinal axis.. This event is reported in the crash sequence variables on the Case Form. It is assumed a rollover will generally involve contact with the road surface or ground. In this situation, the object contacted is encoded **Overturn - rollover** and not **Ground**.

**Rollover — end-over-end**

is used whenever a vehicle rolls over or overturns primarily about the lateral axis of the vehicle.

**Fire or explosion**

is used whenever a vehicle fire or explosion occurs during the crash sequence or as a result of the crash.

**Jackknife**

is used whenever there is sufficient uncontrolled rotation (articulation) between a towing unit and a trailing unit such that they contact each other resulting in direct damage to the towing unit. Jackknife may occur to any vehicle which is pulling a trailing unit by a fixed linkage so long as the trailing unit and the pulling vehicle are capable of rotating (articulating) with respect to each other.

**Other intraunit damage (specify):**

is used whenever there is sufficient uncontrolled motion (other than **Jackknife**) between a towing unit and a trailing unit such that they contact each other resulting in direct damage to the towing unit.

Object Contacted (cont'd)

Page 3 of 10

**Remarks:**

**Noncollision (cont'd)**

**Noncollision Injury**

is used when the event is a noncollision injury (e.g., fell from vehicle)

**Other noncollision (specify)**

is used only in consultation with the zone center.

**Noncollision — details unknown**

is used when it is known that the event was a noncollision but specifics are not known.

**Collision With Fixed Object**

When a vehicle impacts a tree, shrubbery, bush, pole or post and causes the fixed object or any portion thereof to become dislodged or airborne such that the object or portion thereof subsequently falls on the vehicle, the appropriate object contacted attribute for the object in its dislodged or airborne state is the same as when the object was initially.

**Tree ( $\leq 10$  centimeters in diameter) and Tree ( $> 10$  centimeters in diameter)**

refer to the diameter of the tree measured on the horizontal plane at the point of impact.

**Shrubbery or bush**

refers to vegetation which is usually of a woody multi-stemmed variety and in most instances is low growing rather than tall. Some common examples are boxwood, hawthorn, and mountain laurel.

**Embankment**

is used only when damage or injury results from a vehicle impacting an embankment.

**Breakaway pole or post (any diameter)**

refers to a pole or post which is mounted on a base designed to readily disengage or fracture from an impacting vehicle above a predetermined force level. A pole or post fitted with such a device is a breakaway pole or post; otherwise, it is a nonbreakaway pole. Common types of breakaway bases are illustrated on the following pages.

Examples of breakaway poles or posts follow:

Collision With Fixed Object (cont'd)

Breakaway pole or post (any diameter)

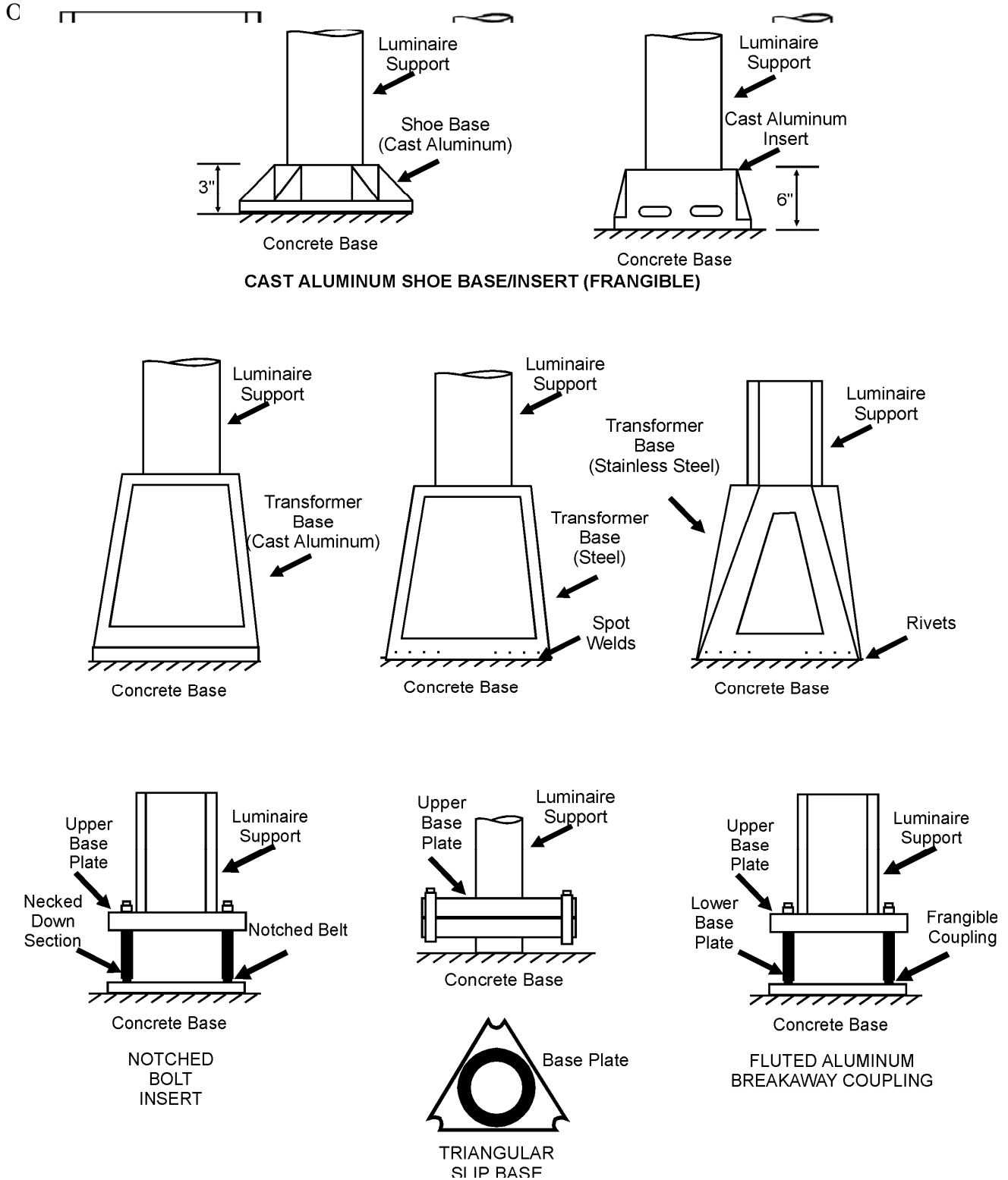



Object Contacted (cont'd)

**Collision With Fixed Object (cont'd)**

**Concrete traffic barrier**

refers to the longitudinal traffic barriers constructed of concrete and located: on the outside of the road surface, in a median, or in gore areas. This includes all temporary concrete barriers regardless of location (*e.g.*, temporary Jersey barrier on a bridge being used to control traffic during bridge repair/construction). Concrete walls (vertical side surfaces) do not apply here, see Wall. Below are a few of the common designs of concrete traffic barriers.

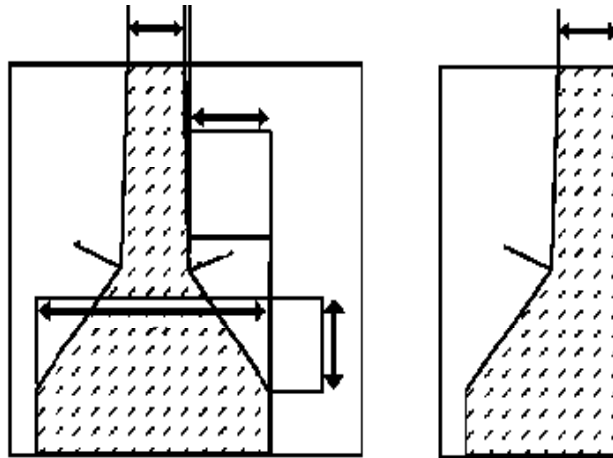

**(Footing & Reinforcing Varies)  
MB 5  
Concrete Median Barrier**

**Concrete  
Safety  
Shape**

Continuously poured, reinforced, sloped faced, concrete section. Barrier can be anchored by dowels or an asphalt key.

**Impact attenuator**

refers to crash cushions which are barriers placed in front of fixed objects on the highway to absorb energy, and thus, to mitigate the injury effects of collisions at such sites. A number of common impact attenuating devices may be encountered; therefore, be sure to photograph them when encountered.

**Other traffic barrier (specify)**

refers to any type of barrier not described in the listed attributes.

Object Contacted (cont'd)

Page 6 of 10

**Collision With Fixed Object (cont'd)****Fence**

includes both the fence material and the support posts.

**Wall**

refers to solid, vertical faced, concrete, brick, stone, or other structurally sound roadside devices which may act as a traffic barrier in some locations. Do not confuse this attribute with **Fence** or **Building**. In most instances a wall will be backfilled with soil and will act as a vertically faced embankment.

**Building**

is used when the vehicle impacts a roofed and walled structure built for permanent use. The type of construction material used is not of interest, nor is the use of the building.

**Ditch or culvert**

refers to: (1) a man-made structure for drainage purposes, or (2) a man-made structure that allows passage over a drainage area and is that part of the structure which is intended to channel flow through the structure and maintain the stability/integrity of the road bed. If the culvert structure has a portion above the road surface which is of sufficient height to engage above the wheels of an errant CDS applicable vehicle and redirect it, that part of the structure is considered an **Other traffic barrier**. When the sides of the ditch are approximately of equal height, it makes no difference which side of the ditch was struck; however, if the struck side is substantially higher than the other side, enter **Embankment** as the object contacted. Substantial means that an embankment exists with or without a ditch

**Ground**

refers to an impact with the ground. Collisions which may be classified using this attribute include (but are not limited to) vehicles which sustain undercarriage damage by (1) straddling the pavement and shoulder and impacting a prominent pavement lip, or (2) free falls or vaults from the road surface to the ground.

**Fire hydrant**

refers to the roadside device used by fire departments to provide water for fighting fires. Usually made of steel, these devices are also referred to as fire plugs or fire stand pipes in some areas.

**Curb**

is used when the vehicle contacts a raised element at the edge of a roadway. Curbs are used to: control drainage, act as deterrents to vehicles leaving the pavement at hazardous points, delineate the edge of the pavement, present a more finished appearance, and assist in the orderly development of the roadway edge. Often a curb serves two or more of these purposes.

**Cable barrier guardrail**

refers to a guardrail consisting of 2 to 4 wire cables supported by cable mounts that are attached to steel posts.



**Guardrail Face**

refers to a cold formed standard W Section or three-beam of steel rigid beam elements bolted to posts usually with offset blocks.

**Guardrail End**

refers to the end of a guardrail. Guardrails can have a separate flat or rounded piece of metal attached to the end of an expanse of guardrail face.



**Bridge**

encompasses all structural members of an overpass structure used for vehicular or pedestrian traffic. This attribute includes guardrails, permanent concrete barriers, bridge rail/walls, bridge piers, bridge abutments, bridge parapet ends, wing walls associated with bridge abutments, and support columns.

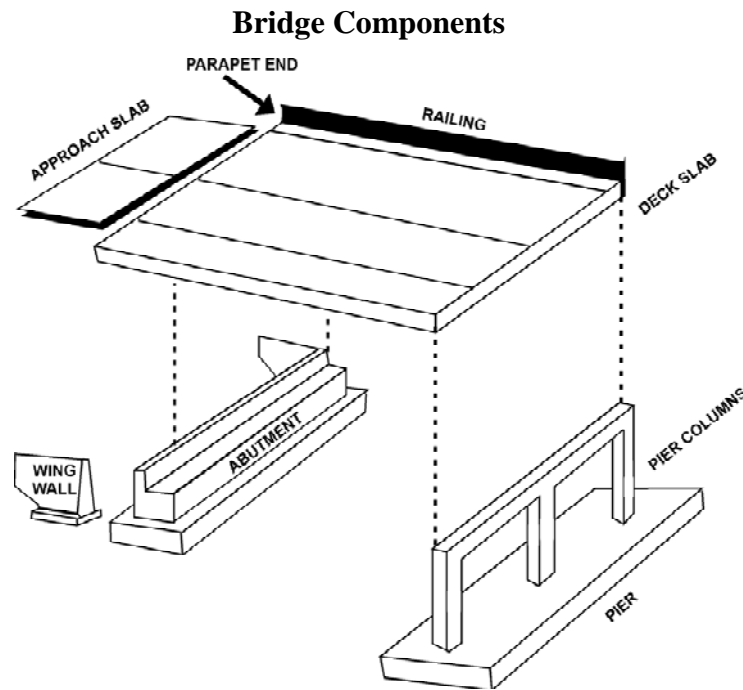

\* Individual components of a bridge collectively become the bridge.

**Other fixed object**

is used for any other object of sufficient mass or anchored such that it is not readily movable; compare with **Other nonfixed object**. Examples include large boulders, large logs (fallen trees), etc.

**Unknown fixed object**

is used when it is known that the vehicle struck a fixed object but the specific type of object is not known.

**Nonbreakaway Pole or Post**

When a vehicle impacts a tree, shrubbery, bush, pole or post and causes the fixed object or any portion thereof to become dislodged or airborne such that the object or portion thereof subsequently falls on the vehicle, the appropriate object contacted attribute for the object in its dislodged or airborne state is the same as when the object was initially.

**Pole or post ( $\leq 10$  centimeters in diameter)**

refers to a pole or post whose diameter, when measured using the method shown above, is less than or equal to ten centimeters, and the pole or post is not mounted on a breakaway base.

**Pole or post ( $> 10$  but  $\leq 30$  centimeters in diameter)**

refers to a pole or post which is not mounted on a breakaway base and whose diameter is within the range specified.

**Pole or post ( $> 30$  centimeters in diameter)**

refers to poles or posts which are of the correct size and are not mounted on a breakaway base.

**Pole, post — diameter unknown**

is used for any pole or post, not on a breakaway base, of unknown diameter.

Use the words "pole" and "post" in a general sense and include all types of supports for utility lines, light standards, post mounted mailboxes, warning devices, signs, and traffic control signals. Privately owned, as well as publicly owned, highway devices are included in these attributes. They may be made of wood, metal, or concrete and may have various cross-sectional shapes and dimensions. The pole or post must be nontemporary (i.e., have a permanent base or be anchored in the ground). Fence posts are not included in these attributes.

The following diagrams coding pole/post:

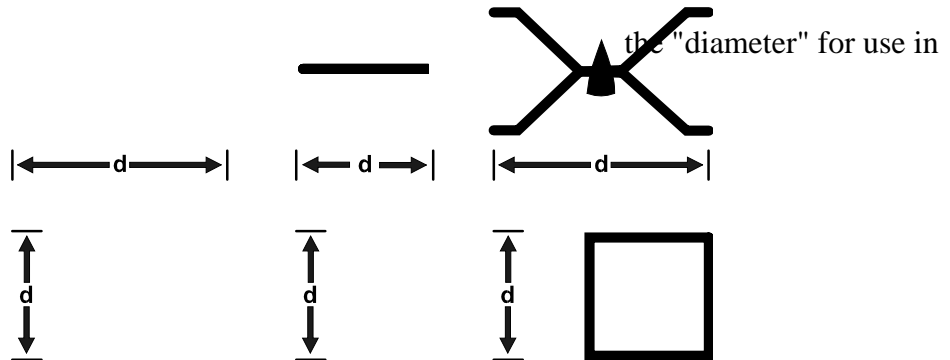

Object Contacted (cont'd)

Page 9 of 10

**Collision with Nonfixed Object****Pedestrian**

is defined as any person who is on a traffic way or on a sidewalk or path contiguous with a traffic way, and who is not in or on a nonmotorist conveyance. This includes persons who are in contact with the ground, roadway, etc., but who are holding onto a vehicle. A nonmotorist conveyance is defined as any human-powered device by which a nonmotorist may move, or by which a pedestrian or nonmotorist may move another nonmotorist, other than by pedaling. A nonmotorist conveyance includes the following: baby carriage, coaster wagon, ice skates, roller skates, push cart, scooter, skate board, skis, sled, wheelchair, rickshaw, etc. This includes those persons in a nonmotorist conveyance who hold onto a motor vehicle in motion. Excluded are pedalcyclists.

**Cyclist or cycle**

refers to any occupant of a pedalcycle, the cycle, or both. This includes those cyclists who hold onto a motor vehicle in motion.

**Other nonmotorist or conveyance**

refers to a person who is not an occupant of a motor vehicle in-transport, a pedestrian, or a cyclist. A nonmotorist conveyance includes the following: baby carriage, coaster wagon, ice skates, roller skates, push cart, scooter, skate board, skis, sled, wheelchair, rickshaw, etc. This includes those persons in a nonmotorist conveyance who hold onto a motor vehicle in motion. Excluded are pedalcyclists. Use this attribute if the impact was with a nonmotorist conveyance or a nonmotorist associated with a nonmotorist conveyance [if an animal is associated with this impact, see **Animal**]. This attribute also would be used for the occupants of a motor vehicle not in-transport, but only if they become separated from the not in-transport vehicle.

**Vehicle occupant**

is used when the object contacted was any person who was an occupant of a motor vehicle in-transport; two examples follow. Use this attribute for an occupant who falls from a vehicle and is subsequently run over before stabilization occurred. In addition, use this attribute for any motorcyclist who separates from his/her motorcycle during impact and subsequently impacts a motor vehicle before stabilization occurred.

**Animal**

is used if the object contacted was an animal (stationary or nonstationary). Where a nonmotorist was associated with the animal (i.e., on the animal, or on or in an animal powered nonmotor vehicle transport device) use the following scheme. If the contact is to:

- (1) the animal; the animal and the person; the animal and the conveyance; or the animal, conveyance, and the person; use the attribute **Animal**;
- (2) the conveyance, or to the person, or to both the conveyance and the person, use the **Other nonmotorist or conveyance**.

**Railway vehicle**

refers to any moving or non-moving vehicle that travels on rails. This includes vehicles that are dual purpose, i.e., a vehicle designed to use both road and rail, if at the time of the crash the vehicle is on rails. Examples are, trolley's on rails and trains.

Object Contacted (cont'd)

Page 10 of 10

**Collision with Nonfixed Object (cont'd)****Trailer, disconnected in transport**

is used when the vehicle is contacted by or contacts a trailer which has become detached from its towing unit while the towing unit was in-transport. The type of trailer is not of interest; the only factors to consider are the detachment of the trailer and the transport status of the towing unit.

**Object fell from vehicle in-transport**

is used when the vehicle is contacted by or contacts an object that was being carried by or was attached to a vehicle in-transport but fell from or became detached from that vehicle. For example, a detached side mirror, spare tire, cargo, etc. Detached trailers are entered under trailer, disconnected in transport.

**Other nonfixed object**

refers to any moveable object that is either readily moveable or is moving and is not specifically named above. Examples include trash cans, grocery carts, unoccupied pedalcycles, small boulders, sheared poles, etc.

**Other Event (specify)**

is used when an event occurs which cannot be classified using one of the existing attributes or definitions. A complete description should be given as well as describing the event in the Case Summary.

**Unknown Event or Object**

is used whenever the object contacted is not known or if an unknown event occurs and the researcher cannot determine what the event consisted of and how to enter it.

**[CLASS OF VEHICLE CONTACTED]**

Page 1 of 2

**Screen Name:** Object Contacted-Class of Vehicle**SAS Data Set:** *EVENT***SAS Variable:** *CLASS2***Oracle Name:** *EVENTS.PICKCONTACTVEHICLECLASS***Element Attributes:**

Oracle	SAS	
0	0	Not a motor vehicle
1	1	Subcompact/mini (wheelbase <254 cm)
2	2	Compact (wheelbase ≥ 254 but <265 cm)
3	3	Intermediate (wheelbase ≥ 265 but <278 cm)
4	4	Full size (wheelbase ≥ 278 but <291 cm)
5	5	Largest (wheelbase ≥ 291 cm)
9	9	Unknown passenger car size
14	14	Compact utility vehicle
15	15	Large utility vehicle (≤ 4,536 kgs GVWR)
16	16	Utility station wagon (≤ 4,536 kgs GVWR)
19	19	Unknown utility type
20	20	Minivan (≤ 4,536 kgs GVWR)
21	21	Large van (≤ 4,536 kgs GVWR)
24	24	Van based school bus ( ≤ 4,536 kgs GVWR)
28	28	Other van type (≤ 4,536 kgs GVWR)
29	29	Unknown van type ( ≤ 4,536 kgs GVWR)
30	30	Compact pickup truck (≤ 4,536 kgs GVWR)
31	31	Large pickup truck (≤ 4,536 kgs GVWR)
38	38	Other pickup truck (≤ 4,536 kgs GVWR)
39	39	Unknown pickup truck type ( ≤ 4,536 kgs GVWR)
45	45	Other light truck (≤ 4,536 kgs GVWR)
48	48	Unknown light truck type (≤ 4,536 kgs GVWR)
49	49	Unknown light vehicle type
50	50	School bus (excludes van based) (>4,536 kgs GVWR)
58	58	Other bus (>4,536 kgs GVWR)
59	59	Unknown bus type
60	60	Truck (>4,536 kgs GVWR)
67	67	Tractor without trailer
68	68	Tractor - trailer(s)
78	78	Unknown medium/heavy truck type
79	79	Unknown light/medium/heavy truck type
80	80	Motored cycle
90	90	Other vehicle
99	99	Unknown

Class of Vehicle Contacted (cont'd)

Page 2 of 2

**Source:** This variable is derived from application inputs from the GV form/Vehicle and Specifications Tab

**Remarks:**

See the descriptions listed under Class of Vehicle.

**Not a motor Vehicle**

Is used when an object is struck.



**GENERAL AREA OF DAMAGE OF VEHICLE CONTACTED**

**Screen Name:** Object Contacted-General Area of Damage

**SAS Data Set:** *EVENT*

**SAS Variable:** *GADEV2*

**Oracle Name:** *EVENTS.PICKCONTACTVEHICLEDAMAGE*

**Element Attributes:**

Oracle	SAS	
0	1/10	Not a motor vehicle
N	2/11	Noncollision
9	21/9	Unknown

**CDC Applicable and Other Vehicles**

Oracle	SAS	
F	3	Front
R	4	Right side
L	5	Left side
B	6	Back of unit with cargo area
T	7	Top
U	8	Undercarriage

**TDC Applicable Vehicles**

Oracle	SAS	
F	12	Front
R	13	Right side
L	14	Left side
B	15	Back of unit with cargo area (rear of trailer or straight truck)
D	16	Back (rear of tractor)
C	17	Rear of cab
V	18	Front of cargo area
T	19	Top
U	20	Undercarriage

**Source:** Researcher determined.

**Remarks:**

See the choices listed under General Area of Damage

**Not a motor Vehicle**

Is used when an object is struck.

## SCENE

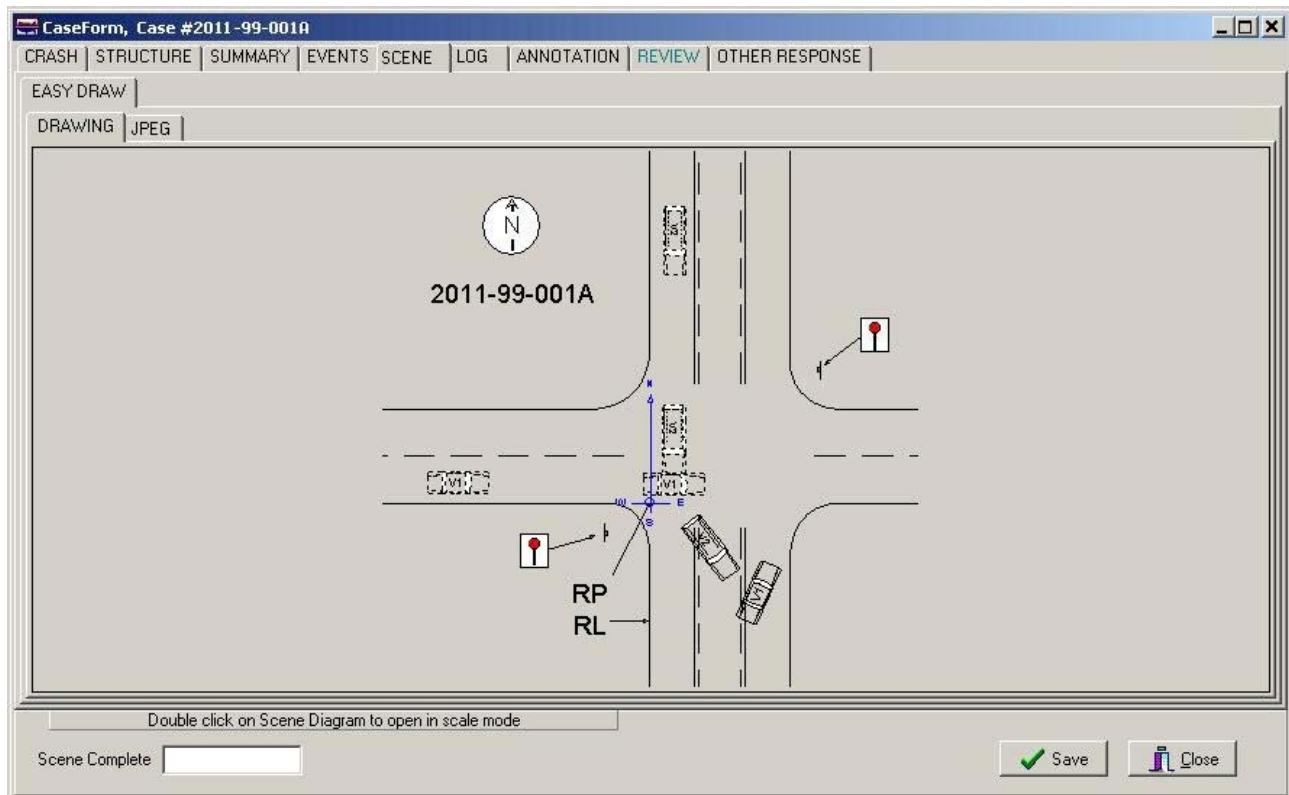

### Scene Diagram

Once you have clicked on the Scene tab to open up a grey window, double click on the window to start.

Use reference materials or “Help” in the drawing program, for various techniques.

Appendix E contains the Uniform Symbols for Crash Diagramming for use in completing the scene diagram.

The scene diagram should include the following:

#### Document the physical plant:

- All appropriate road/roadway delineation (e.g., curbs/edge lines, lane markings, median markings, pavement markings, parked vehicles, poles, signs, etc.)
- All appropriate traffic controls (e.g., signs/signals, etc.)
- North arrow placed on diagram

#### Document vehicle dynamics including:

- Reference Point (RP) and Reference Line (RL) relative to the physical features present at the scene
- Scaled documentation of all crash induced physical evidence.
- Scaled documentation of all roadside objects contacted

- Scaled representations of the vehicle(s) at pre-impact, impact, and final rest based upon either physical evidence, and/or reconstructed crash dynamics.

**DATE SCENE COMPLETED (MONTH/DAY/YEAR)**

**Screen Name:** Scene Complete

**SAS Data Set:** N/A

**SAS Variable:** N/A

**Oracle Name:** *CASESTRUCTURE.SCENECOMPLETEDATE*

**Element Attributes:**

Month: 01-12

Day: 01 through 31

Year: Calendar year of data collection

**Source:** Researcher

**Remarks:**

Enter the date that the required scene inspection (including field sketch) was completed.

ANNOTATIONS

CaseForm, Case #2007-996-900015

CRASH | STRUCTURE | SUMMARY | EVENTS | SCENE | ANNOTATION | REVIEW | OTHER RESPONSE

ANNOTATIONS | FIELD ANNOTATIONS (OLD)

Form Name	Class/Form	Veh#	Occ#

Save Close

**ANNOTATION**

**Screen Name:** Annotations

**SAS Data Set:** N/A

**SAS Variable:** N/A

**Oracle Name:** ANNOTATION.ANNOTATIONTEXT

**Element Attributes:**

**Source:** Researcher

**Remarks:**

All annotations to the case are referenced here. Annotations can be deleted by highlighting the annotation and deleting.

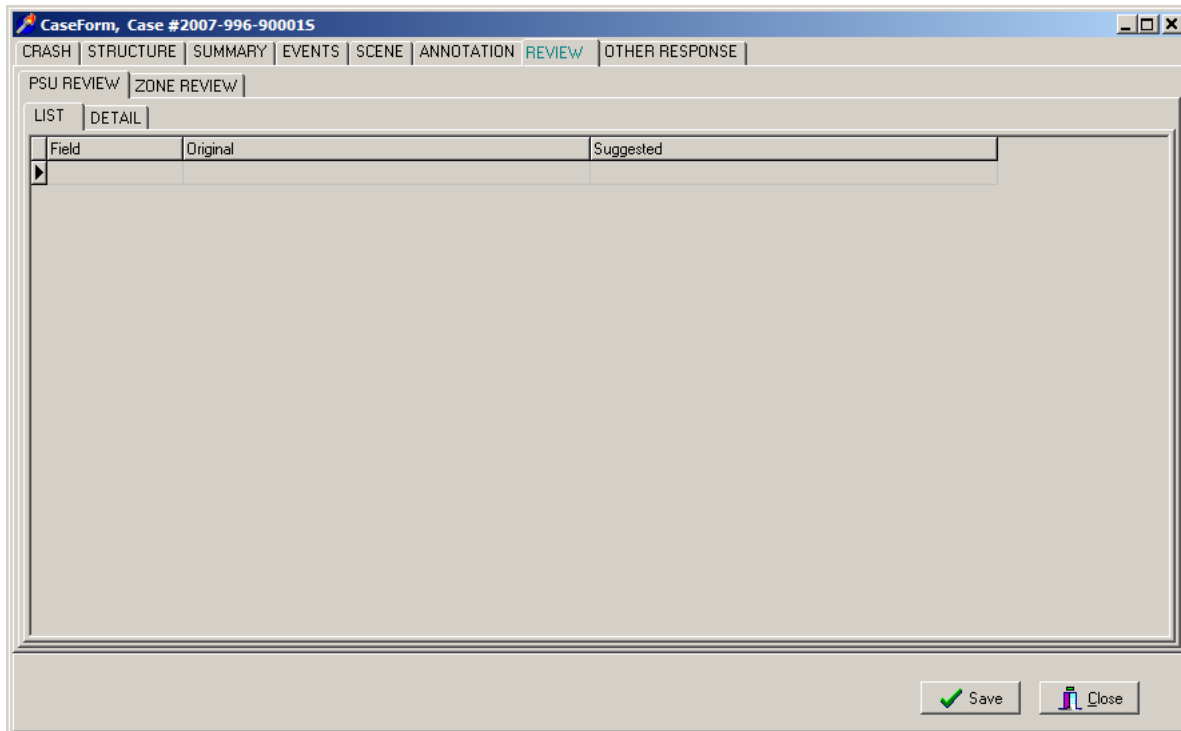
**PSU REVIEW****PSU Review**

The case review process is a critical part of NASS quality control. Reviews are completed at the PSU, Zone Center, and NHTSA levels. The NASSMAIN program is equipped with an electronic case review that allows suggested changes to be entered and stored in the case. It is imperative that cases be reviewed in a tab-by-tab manner.

When conducting an electronic case review, it is important to enter the case in the “PSU Review” mode. Select “File” from the menu bar and select “PSU Review” from the opened window. All aspects of the case can be reviewed in this mode, but no changes can be made to the case. The method for suggesting changes varies with the type of data being reviewed.

Fixed variables have drop-down boxes that open a window of attributes from which to choose. In the “PSU Review” mode, select the variable for which a suggested change will be made. When the variable box is shaded blue, push the F5 key on the keyboard. A window will pop up displaying the coded attribute, a suggestion box for recommending a new attribute, and a comment box. The suggestion box will contain the same attribute choices available during data entry. Selected the proposed attribute change and, if needed, enter justification for the change in the comment box. A list of the suggested changes is compiled under “Review” on the menu bar.

Case components such as summaries, scene diagrams, or sketches can be viewed in the “PSU Review” mode, but suggestion boxes are not available. Select the “Review” option from the menu bar and select the “Notes” option. A text box appears in which any suggestions can be entered. It is recommended to enter each suggested change on a new line of text to allow for easier reading and for additional comments from the case researcher.

When the review is complete, the case researcher should enter the case through the “Researcher Entry” mode so that potential changes can be made. Suggested variable changes that are agreed upon should be changed in the case. For suggestions with which the case researcher disagrees, justification for retaining the variable as coded may be entered in the comment box. Similarly, justification may be entered for suggestions in the “Notes” section that are not acted upon.

*It is important to leave all case review notes and suggestions in the case for use in zone center review.*



**ZONE REVIEW**

The screenshot shows a software window titled "CaseForm, Case #2007-996-900015". The interface includes a top menu bar with options: CRASH | STRUCTURE | SUMMARY | EVENTS | SCENE | ANNOTATION | REVIEW | OTHER RESPONSE. Below this is a sub-menu with PSU REVIEW and ZONE REVIEW. Under ZONE REVIEW, there are LIST and DETAIL options. A table is displayed with three columns: Field, Original, and Changed to. The table is currently empty. At the bottom right of the window, there are two buttons: a "Save" button with a green checkmark icon and a "Close" button with a red X icon.

**Zone Center Review**

Two types of case review conducted at the zone center are:

1. All variable review OR
2. Key variable/specified review

All aspects of the case are reviewed (all variable review) based upon researcher status as follows:

- Novice (1<sup>st</sup> 20 cases completed)
- Probationary
- Twenty-five percent of experienced researcher cases are reviewed (excludes researchers on probation).

**All variable review**

All aspects of a case will be reviewed to assess accuracy, completeness, and quality of case with respect to NASS program standards as indicated by source documents and researcher training.

Areas of exception as well as deficient performance will be assessed based on NHTSA's established guideline for NASS using the following source documents:

- CDS Coding and Editing Manual
- SAE J224 MAR80 .
- Photography Guideline
- Vehicle Measurement Techniques
- WINSMASH Decision Rules

- Researcher training
- Established NASS Edit Checks

**Key Variable/Specified review:**

Key variable reviews are performed on cases with variables designated to be of special interest and will typically include the following:

- Pre crash
- Rollover
- WINSMASH
- Restraint systems

All cases are checked to ensure they are applicable and selected based on established sampling rules.

In addition to case review, Zone Center personnel are responsible for the coding and sourcing of official and unofficial medical/injury data.

OTHER RESPONSE

CaseForm, Case #2007-996-900015

CRASH | STRUCTURE | SUMMARY | EVENTS | SCENE | ANNOTATION | REVIEW | OTHER RESPONSE

Veh #	Occ #	ID4	ID5	Table	Column	Other Specified
-------	-------	-----	-----	-------	--------	-----------------

Save Close

**OTHER RESPONSE**

**Screen Name:** Other Response

**SAS Data Set:** N/A

**SAS Variable:** N/A

**Oracle Name:** ***OTHERRESPONSES.OTHERTEXT***

**Element Attributes:**

**Source:** Researcher

**Remarks:**

A list of all Other Specified information within the case. Used primarily for case review.

**GENERAL VEHICLE FORM OVERVIEW**

Page 1 of 2

The General Vehicle Form provides information for all motor vehicles involved in the case's harmful events.

The form is divided into several main tabs:

- Vehicle
- Specifications
- Official Records
- Precrash
- Driver
- Rollover
- Reconstruction
- DeltaV
- Log

The Vehicle tab provides basic identification information regarding this vehicle, as well as the type of inspection completed. The amount of information completed on this form is determined by the vehicle type:

- CDS in-transport: All tabs are completed.
- CDS not in-transport, inspected: Vehicle and Specifications tabs only.
- non-CDS vehicle: Vehicle, Official Records, PreCrash, Driver and Log tabs.

The Specifications tab lists the dimensions of the vehicle.

The Official Records tab lists information normally gleaned from the police report or medical records.

The PreCrash tab provides information normally collected during the scene inspection. It details the different precrash characteristics of the roadway for this vehicle.

The Driver tab provides information about the movement of the vehicle during the precrash phase of the crash.

The Rollover tab provides information regarding any rollover a vehicle may have experienced during the crash. If no rollover event occurred for this vehicle, then all fields will be coded "No rollover."

The Reconstruction tab provides basic trajectory information regarding the vehicle.

The DeltaV tab provides delta V information for the vehicle's highest severity impact.

The Log tab includes management information regarding the case.

VEHICLE

General Vehicle Form, Case 2007-8701-009K/ Vehicle #1

VEHICLE | SPECIFICATIONS | OFFICIAL RECORDS | PRECRASH | DRIVER | ROLLOVER | RECONSTRUCTION | DELTA V | LOG | REVIEW

**Identification**

Number: 1      Identification Number:

Model Year: 2007      Vehicle Special Use: No Special Use

Make: TOYOTA      Transport Status: In transport

Model: CAMRY

Body Category: Automobiles

Body Type: 3-door coupe

Class: Compact (wheelbase >= 254 but < 265 cm)

**Weight**

Curb Weight: 907 kgs

Source:

Cargo Weight:  kgs

Source:

**Inspection**

Complete Inspection

Date: 01/03/2007

Save      Close

**VEHICLE NUMBER**

**Screen Name:** Number

**SAS Data Set:** *GV*

**SAS Variable:** *VEHNO*

**Oracle Name:** *VEHICLE.VEHICLENUMBER*

**Element Attributes:**

Generated Number

**Range:**

**Source:** Generated when vehicle is selected to open General Vehicle Form

**Remarks:**



**VEHICLE MODEL YEAR**

**Screen Name:** Identification--Model Year

**SAS Data Set:** *GV*

**SAS Variable:** *MODELYR*

**Oracle Name:** *VEHICLE.MODELYEAR*

**Element Attributes:**

Oracle	SAS	
	1900	current data collection year plus one
-9999	9999	Unknown

**Range:** 1900-current year+1

**Source:** Primary source is the VIN during vehicle inspection; secondary sources include the police report and interviews.

**Remarks:****Unknown**

is used if the vehicle model year cannot be determined.

**VEHICLE MAKE**

**Screen Name:** Identification--Make

**SAS Data Set:** *GV*

**SAS Variable:** *MAKE (for SAS code); OMAKE (for Oracle code)*

**Oracle Name:** *VEHICLE.MAKEID*

**Element Attributes:**

Oracle SAS

99	99	Vehicle Make-as Selected
		Unknown Manufacturer

**Source:** Vehicle inspection, police report, and interview

**Remarks:**

Select the vehicle make for this vehicle. Make Model list is in the Appendix.

**Unknown**

is used for a "hit-and-run" vehicle unless reliable evidence indicates the make of the vehicle.

**VEHICLE MODEL**

**Screen Name:** Identification—Model

**SAS Data Set:** *GV*

**SAS Variable:** *MODEL (for SAS code); OMODEL (for Oracle code)*

**Oracle Name:** *VEHICLE.MODELID*

**Element Attributes:**

Oracle	SAS	Vehicle Model-as Selected
-9999	999	Unknown

**Source:** Vehicle inspection, police report, and interview

**Remarks:**

Select the vehicle model for this vehicle. Make Model list is in the Appendix.

**Unknown**

is used for a "hit-and-run" vehicle unless reliable evidence indicates the make of the vehicle.

**VEHICLE BODY CATEGORY**

**Screen Name:** Body Category

**SAS Data Set:** N/A

**SAS Variable:** N/A

**Oracle Name:** *VEHICLE.PICKVEHICLETYPE*

**Element Attributes:**

Oracle	SAS
1	Automobiles
2	Automobile Derivatives
3	Utility Vehicles
4	Van Based Light Trucks
5	Light Conventional Trucks
6	Other Light Trucks
7	Buses (Excludes Van Based GVWR $\geq$ 4,536 kgs)
8	Medium/heavy Trucks
9	Motored Cycles
10	Other Vehicles
-9999	Unknown Body Type

**Source:** Vehicle inspection, police report, interview, VIN

**Remarks:**

**Automobiles**

These light vehicles referred to as automobiles, are designed primarily to transport passengers.

**Automobile Derivatives**

This describes certain passenger cars that have been modified to perform cargo-related tasks.

**Utility Vehicles (< 4,536 kgs GVWR)**

**Van Based Light Trucks (< 4,536 kgs GVWR)**

**Light Conventional Trucks (Pickup Style Cab, < 4,536 kgs GVWR)**

**Other Light Trucks (< 4,536 kgs. GVWR)**

Other Light Trucks are used to describe vehicles that are based upon a conventional light pickup frame, but a commercial or recreational body has been affixed to the frame rather than a pickup box.

**Buses (Excludes Van Based Buses GVWR  $\geq$  4,536 kgs)**

Buses are defined as any medium/heavy motor vehicle designed primarily to transport large groups of passengers.

**Medium/Heavy Trucks (> 4,536 kgs GVWR)**

Medium/Heavy Trucks describe a single unit truck specifically designed for carrying cargo on the same chassis as the cab. They pertain to a truck-tractor designed for towing trailers or semi-trailers. Although towing is their primary purpose, some truck-tractors are equipped with cargo areas located rearward of the cab.

**Motored Cycles (Does Not Include All Terrain Vehicles/Cycles)****Other Vehicles**

Other Vehicles describe all motored vehicles that are designed primarily for off-road use. It is also selected when the body type of the vehicle is unknown.

**BODY TYPE**

Page 1 of 13

Screen Name: Body Type

SAS Data Set: GV

SAS Variable: BODYTYPE

Oracle Name: VEHICLE.BODYTYPEID

**Element Attributes:****CDS APPLICABLE VEHICLES****Automobiles**

Oracle	SAS	
01	01	Convertible (excludes sun-roof, t-bar)
02	02	2-door sedan, hardtop, coupe
03	03	3-door/2-door hatchback
17	17	3-door coupe
04	04	4-door sedan, hardtop
05	05	5-door/4-door hatchback
06	06	Station wagon (excluding van and truck based)
07	07	Hatchback, number of doors unknown
08	08	Other automobile type (specify):
09	09	Unknown automobile type

**Automobile Derivatives**

Oracle	SAS	
10	10	Auto based pickup (includes El Camino, Caballero, Ranchero, Brat, and Rabbit pickup)
11	11	Auto based panel (cargo station wagon, auto based ambulance/hearse)
12	12	Large limousine - more than four side doors or stretched chassis
13	13	Three-wheel automobile or automobile derivative

**Utility Vehicles (<=4,536 kgs GVWR)**

Oracle	SAS	
14	14	Compact utility (examples include: 4-Runner, Amigo, Bravada, Bronco [76 and before], Bronco II, Cherokee [84 and after], Defender, Discovery, Dispatcher, Explorer, Geo Tracker, Golden Eagle, Grand Vitara, Jeep CJ-2 - CJ-7, Laredo, Montero, Mountaineer, Navajo, Passport, Pathfinder, Raider, RAV4, RX-300, Renegade, Rocky, Rodeo, S-10 Blazer, S-15 Jimmy, Samurai, Scrambler, Sidekick, Sportage, Thing, Trooper, Trooper II, Wrangler, Xterra, X-90)

Body Type (cont'd)

Page 2 of 13

Oracle	SAS	
15	15	Large utility (examples include: Bronco-full-size [78 and after], full-size Blazer, Expedition, full-size Jimmy, Hummer, Jeep Cherokee [83 and before], Durango, Escalade, Landcruiser, LX450, Navigator, Ramcharger, RangeRover, Scout, Tahoe, Trailduster, Yukon)
16	16	Utility station wagon (examples include: Chevrolet Suburban, Excursion, GMC Suburban, Grand Wagoneer includes suburban limousine, Travelall)
19	19	Utility, unknown body type

**Van Based Light Trucks (<=4,536 kgs GVWR)**

Oracle	SAS	
20	20	Minivan (examples include: Aerostar, Astro, Caravan, Expo Wagon, Grand Caravan, Grand Voyager, Lumina APV, Mazda MPV, Mini-Ram, Mitsubishi Minivan, Nissan Minivan, Odyssey, Previa, Quest, Safari, Sienna, Silhouette, Town and Country, Toyota Minivan, Toyota Van, Trans Sport, Vanagon/Camper, Venture, Villager, Vista, Voyager, Windstar)
21	21	Large van (examples include: B150-B350, Beauville, Chateau, Chevy Van, Clubwagon, E150- E350, Econoline, G10-G30, G15-G35, Maxiwagon, Rally Van, Ram, Royal, Sport Van, Sportsman, Tradesman, Vandura, Voyager [83 and before].)
22	22	Step van or walk-in van (<=4,536 kgs GVWR)
23	23	Van based motorhome (<=4,536 kgs GVWR)
24	24	Van based school bus (<=4,536 kgs GVWR)
25	25	Van based other bus (<=4,536 kgs GVWR)
28	28	Other van type (Hi-Cube Van, Kary) (specify):
29	29	Unknown van type

**Light Conventional Trucks (Pickup style cab, <=4,536 kgs GVWR)**

Oracle	SAS	
30	30	Compact pickup (examples include: Arrow Pickup [foreign], Colt P/U, Courier, D50, Dakota, Datsun/Nissan Pickup, Frontier, Hombre, LUV, Mazda Pickup, Mitsubishi Pickup, Pup, Ram 50, Ranger, S-10 , S-15, Sonoma, Sport Trac, T-10, T-15, Tacoma, Toyota Pickup)
31	31	Large Pickup (examples include: C10-C35, Comanche, D100-D350, F100-F350, Jeep Pickup, K10-K35, R100-R500, R10-R35, Ram Pickup, Sierra, Silverado, T100, V10-V35, W100-W350)
32	32	Pickup with slide-in camper
33	33	Convertible pickup
39	39	Unknown pickup style light conventional truck type

Body Type (cont'd)

Page 3 of 13

**Other Light Trucks (<=4,536 kgs GVWR)**

Oracle	SAS	
40	40	Cab chassis based (includes rescue vehicles, light stake, dump, and tow truck)
41	41	Truck based panel
42	42	Light truck based motorhome (chassis mounted)
45	45	Other light conventional truck type
48	48	Unknown light truck type
49	49	Unknown light vehicle type (automobile, utility, van, or light truck)

**OTHER VEHICLES****Buses (Excludes Van Based ≥4,536 kgs GVWR)**

Oracle	SAS	
50	50	School bus (designed to carry students, not cross country or transit)
55	55	Buses (Excludes Van Based GVWR ≥ 4,536 kgs)
58	58	Other bus type (e.g., transit, intercity, bus based motorhome) (specify)
59	59	Unknown bus type

**Medium/Heavy Trucks (> 4,536 kgs GVWR)**

Oracle	SAS	
60	60	Step van (> 4,536 kgs GVWR)
61	61	Single unit straight truck/Cab chasis (4,536 kgs <GVWR<=8,845 kgs)
62	62	Single unit straight truck (8,845 kgs <GVWR<=11,793 kgs)
63	63	Single unit straight truck (> 11,793 kgs GVWR)
64	64	Single unit straight truck, GVWR unknown
65	65	Medium/heavy truck based motorhome
67	67	Truck-tractor with no cargo trailer
68	68	Truck-tractor pulling one trailer
69	69	Truck-tractor pulling two or more trailers
70	70	Truck-tractor (unknown if pulling trailer)
39462	74	Medium/Heavy Pickup ≥4,536 kgs
78	78	Unknown medium/heavy truck type

**Unknown truck type (light/medium/heavy)**

Oracle	SAS	
79	79	Unknown truck type (light/medium/heavy)

**Motored Cycles (Does Not Include All-Terrain Vehicles/Cycles)**

Oracle	SAS	
80	80	Motorcycle
81	81	Moped (motorized bicycle)
82	82	Three-wheel motorcycle or moped



88	88	Other motored cycle (minibike, motor scooter) (specify):
Body Type (cont'd)		

Page 4 of 13

Oracle	SAS	
89	89	Unknown motored cycle type

**Other Vehicles**

Oracle	SAS	
90	90	ATV (All-Terrain Vehicle) and ATC (All-Terrain Cycle)
91	91	Snowmobile
92	92	Farm equipment other than trucks
93	93	Construction equipment other than trucks
94	94	Low Speed Vehicles (LSV)/Neighborhood Electric Vehicles (NEV)
97	97	Other vehicle type

**Unknown Vehicle Type**

Oracle	SAS	
99	99	Unknown body type

**Source:** Vehicle inspection, police report, and interview**Remarks:**

If the gross vehicle weight rating (GVWR) can not be determined assume it is less than 4,536 kgs. The vehicle stays the same GVWR as it was sampled

**Automobiles**

These light vehicles referred to as automobiles, are designed primarily to transport passengers.

**01 Convertible (excludes sun-roof, t-bar)**

refers to a passenger car equipped with a removable or retractable roof. To qualify for this attribute, the entire roof must open. Convertible roofs are generally fabric; however, removable hardtops are also included. This attribute takes priority over 2-door or 4-door attributes.

**02 2-door sedan, hardtop, coupe**

refers to a passenger car equipped with two doors for ingress/egress and a separate trunk area for cargo (*i.e.*, trunk lid hinged below the backlight). Folding rear seats do not necessarily violate the separate "trunk area" concept.

**03 3-door/2-door hatchback**

refers to a passenger car equipped with two doors for ingress/egress and a rear hatch opening for cargo (*i.e.*, hinged above the backlight). The cargo area is not permanently partitioned from the passenger compartment area.

Body Type (cont'd)

Page 5 of 13

**17 3-door coupe**

refers to a passenger car equipped with three doors (two front seat and one rear seat) for ingress/egress and a separate trunk area for cargo (*i.e.*, trunk lid hinged below the backlight). Folding rear seats do not necessarily violate the separate "trunk area" concept.

**04 4-door sedan, hardtop**

refers to a passenger car equipped with four doors for ingress/egress and a separate trunk area for cargo (*i.e.*, trunk lid hinged below the backlight). Folding rear seats do not necessarily violate the separate "trunk area" concept.

**05 5-door/4-door hatchback**

refers to a passenger car equipped with four doors for ingress/egress and a rear hatch opening for cargo (*i.e.*, hinged above the backlight). The cargo area is not permanently partitioned from the passenger compartment area.

**06 Station wagon (excluding van and truck based)**

refers to a passenger car with an enlarged cargo area. The entire roof covering the cargo area is generally equal in height from front to rear and full height side glass is installed between the C and D-pillars. The rearmost area is not permanently partitioned from the forward passenger compartment area (*e.g.*, "horizontal window shades" to hide cargo do not constitute partitions).

**07 Hatchback, number of doors unknown**

refers to a passenger car with an unknown number of doors for ingress/egress and a rear hatch opening for cargo (*i.e.*, hinged above the backlight). The cargo area is not permanently partitioned from the passenger compartment area.

**08 Other automobile type**

refers to any passenger car that cannot be described by other automobile attributes.

**09 Unknown automobile type**

is used when it is known that the vehicle is a passenger car, but there is insufficient data to determine the type.

**Automobile Derivatives**

This describes certain passenger cars that have been modified to perform cargo-related tasks.

**10 Auto based pickup**

refers to a passenger car based, pickup type vehicle (includes El Camino, Caballero, Ranchero, Brat, and Rabbit pickup). The roof area (and side glass) rearward of the front seats on a station wagon have been removed and converted into a pickup-type cargo box.

Body Type (cont'd)

Page 6 of 13

**11 Auto based panel**

refers an automotive station wagon that may have sheet metal rearward of the B-pillar rather than glass (cargo station wagon, auto based ambulance/hearse).

**12 Large limousine**

refers to an automobile that has sections added within its wheelbase (more than four side doors) or stretched chassis to increase length and passenger/cargo carrying capacity .

**13 Three-wheel automobile or automobile derivative**

refers to three-wheel vehicles with an enclosed passenger compartment.

**Utility Vehicles (<=4,536 kgs GVWR)****Multi-purpose vehicles (MPV)**

are designed to have off-road capabilities. These vehicles are generally four wheel drive (4 x 4), have increased ground clearance, and are equipped with a strong frame. Four wheel drive automobiles are not considered MPVs.

**14 Compact utility**

refers to a short wheelbase and narrow tracked multi-purpose vehicle designed to operate in rugged terrain (examples include: 4-Runner, Amigo, Bravada, Bronco [76 and before], Bronco II, Cherokee [84 and after], Defender, Discovery, Dispatcher, Explorer, Geo Tracker, Golden Eagle, Grand Vitara, Jeep CJ-2 - CJ-7, Laredo, Montero, Mountaineer, Navajo, Passport, Pathfinder, Raider,

RAV4, RX-300, Renegade, Rocky, Rodeo, S-10 Blazer, S-15 Jimmy, Samurai, Scrambler, Sidekick, Sportage, Thing, Trooper, Trooper II, Wrangler, Xterra, X-90)

**15 Large utility**

refers to full-size multi-purpose vehicles primarily designed around a shortened pickup truck chassis. While generally a station wagon style body, some models are equipped with a removable top (examples include: Bronco-full-size [78 and after], full-size Blazer, Expedition, full-size Jimmy, Hummer, Jeep Cherokee [83 and before], Durango, Escalade, Landcruiser, LX450, Navigator, Ramcharger, RangeRover, Scout, Tahoe, Trailduster, Yukon).

**16 Utility station wagon**

refers primarily to a pickup truck based chassis enlarged to a station wagon (examples include: Chevrolet Suburban, Excursion, GMC Suburban, Travelall, Grand Wagoneer, includes suburban limousine).

**19 Utility, unknown body type**

is used when it is known that the vehicle is a utility vehicle, but there is insufficient data to determine the specific type. Class of Vehicle is entered as **(Compact utility vehicle)**.

Body Type (cont'd)

Page 7 of 13

**Van Based Light Trucks (<=4,536 kgs GVWR)**

Light trucks (<=4,536 kgs GVWR) are designed to maximize cargo/passenger area versus overall length. Basically a "box on wheels" these vehicles are identifiable by their enclosed cargo/passenger area and relatively short (or non-existent) hood.

**20 Minivan**

refers to down-sized cargo or passenger vans examples include: Aerostar, Astro, Caravan, Expo Wagon, Grand Caravan, Grand Voyager, Lumina APV, Mazda MPV, Mini-Ram, Mitsubishi Minivan, Nissan Minivan, Odyssey, Previa, Quest, Safari, Sienna, Silhouette, Town and Country, Toyota Minivan, Toyota Van, Trans Sport, Vanagon/Camper, Venture, Villager, Vista, Voyager, Windstar).

**21 Large van**

refers to a standard cargo or passenger van (examples include: B150-B350, Sportsman, Royal, Maxiwagon, Ram, Tradesman, Voyager [83 and before], E150-E350, Econoline, Clubwagon, Chateau, G10-G30, Chevy Van, Beauville, Sport Van, G15-G35, Rally Van, Vandura). These vans will generally have a larger capacity in both volume and GVWR.

**22 Step van or walk-in van (<=4,536 kgs GVWR)**

refers to a multi-stop delivery vehicle with a GVWR less than or equal to 4,536 kilograms. Examples are the Grumman LLV used by the US Postal Service or the Aeromate manufactured by Utilimaster Motor Corporation.

**23 Van based motorhome (<=4,536 kgs GVWR)**

refers to a van where the chassis and cab portions from the B-pillar forward of this vehicle are the same as in attributes minivan, large van, step van, however, a frame mounted recreational unit is added behind the driver/cab area. This attribute takes priority over attributes minivan and large van.

**24 Van based school bus (<=4,536 kgs GVWR)**

is a passenger van designed to carry students (passengers) to and from educational facilities and/or related functions. The vehicles are characteristically painted yellow and clearly identified as school buses. Use this attribute regardless of whether the vehicle is owned by a school system or a private company. Van based school buses converted for other uses (*e.g.*, church bus) also take this attribute.

**25 Van based other bus (<=4,536 kgs GVWR)**

is a van derivative (*e.g.*, taxi, small local transit) designed to carry passengers for low occupancy functions or purposes. Van based school buses do not use this attribute.

Body Type (cont'd)

Page 8 of 13

**28 Other van type (Hi-Cube Van, Kary)**

refers to a cargo or delivery van where that chassis and cab portions from the B-pillar forward of this vehicle are the same as in Minivans and Large Vans with a frame mounted cargo area unit added behind the driver/cab area, or if the van cannot be described as a Minivan, Large Van, Step-van or a Van-based motorhome. Annotate the van type when using this attribute. This attribute takes priority over Minivans and Large Vans.

**29 Unknown van type**

is used when it is known that this vehicle is a light van, but its specific type cannot be determined.

**Light Conventional Trucks (Pickup Style Cab, <=4,536 kgs GVWR)**

Light Conventional Trucks are used to describe vehicles commonly referred to as pickup trucks and some of their derivatives. These light trucks are characteristically designed with a small cab containing a single row of seats (extended cabs with additional seats are available for some models), a large hood covering a conventional engine placement, and a separate open box area (approximately 180 to 240 centimeters long) for cargo.

**30 Compact pickup**

is used to describe a pickup truck having a width of 178 centimeters or less. (examples include: Arrow Pickup [foreign], Colt P/U, Courier, D50, Dakota, Datsun/Nissan Pickup, Frontier, Hombre, LUV, Mazda Pickup, Mitsubishi Pickup, Pup, Ram 50, Ranger, S-10, S-15, Sonoma, T-10, T-15, Tacoma, Toyota Pickup)

**31 Large Pickup**

is used to describe a pickup truck having a width of greater than 178 centimeters (examples include: C10-C35, Comanche, D100-D350, F100-F350, Jeep Pickup, K10-K35, R100-R500, R10-R35, Ram Pickup, Sierra, Silverado, T100, V10-V35, W100-W350)

**32 Pickup with slide-in camper**

is used to describe any pickup truck that is equipped with a slide-in camper. A slide-in camper is a unit that mounts within a pickup bed. Pickup bed caps, tonneau covers, or frame mounted campers are not applicable for this attribute.

**33 Convertible pickup**

refers to a pickup truck equipped with a removable or retractable roof. To qualify for this attribute, the entire roof must open. Convertible roofs are generally fabric; however, removable hardtops are also included. This attribute takes priority over compact and large pickups.

**39 Unknown pickup style light conventional truck**

is used when this vehicle is a Light Conventional Trucks, but there is insufficient data to determine the specific attribute.

Body Type (cont'd)

Page 9 of 13

**Other Light Trucks (<=4,536 kgs. GVWR)**

Other Light Trucks are used to describe vehicles that are based upon a conventional light pickup frame, but a commercial or recreational body has been affixed to the frame rather than a pickup box.

**40 Cab chassis based** (includes rescue vehicles, light stake, dump, and tow truck) is used to describe a light vehicle with a pickup style cab and a commercial (non-pickup) body attached to the frame. Included are pickup based ambulances and tow trucks.

**41 Truck based panel** is used to describe a truck based station wagon that has sheet metal rather than glass above the beltline rearward of the B-pillars.

**42 Light truck based motorhome (chassis mounted)** is used to describe a frame mounted recreational unit attached to a light van or conventional chassis.

**45 Other light conventional truck type** is used for light conventional trucks that cannot be described elsewhere.

**48 Unknown light truck type** is used when it is known that the vehicle is a light truck chassis based vehicle but insufficient data exist to specify what type of light truck it is.

**49 Unknown light vehicle type (automobile, utility, van, or light truck)** is used when it is known that the vehicle is a light vehicle, but insufficient data exists to specify what type of light truck it is.

**Buses (Excludes Van Based)**

Buses are defined as any medium/heavy motor vehicle designed primarily to transport large groups of passengers.

**50 School bus**

(designed to carry students, not cross country or transit) is a bus designed to carry passengers to and from educational facilities and/or related functions. The vehicles are characteristically painted yellow and clearly identified as school buses. Use this attribute regardless of whether the vehicle is owned by a school system or a private company. School buses converted for other uses (*e.g.*, church bus) also take this attribute.

**55 Buses (Excludes Van Based GVWR ≥ 4,536 kgs)**

describes a bus body type built on a van based chassis.

Body Type (cont'd)

Page 10 of 13

**58 Other bus type**

(e.g., transit, intercity, bus based motorhome) is a transport device designed to carry passengers for longer periods of time. These vehicles may be classified as over-the-road, transit, intercity, bus related motorhome (other than school bus based), or other.

**59 Unknown bus type**

is used when it is known the transport device is a bus but there is insufficient data to choose between attributes School bus and Other bus type.

**Medium/Heavy Trucks (> 4,536 kgs GVWR)**

Medium/Heavy Trucks describe a single unit truck specifically designed for carrying cargo on the same chassis as the cab.

They pertain to a truck-tractor designed for towing trailers or semi-trailers. Although towing is their primary purpose, some truck-tractors are equipped with cargo areas located rearward of the cab.

**60 Step van (> 4,536 kgs GVWR)**

defines a single unit enclosed body with a GVWR greater than 4,536 kilograms and an integral driver's compartment and cargo area. Step vans are generally equipped with a folding driver seat mounted on a pedestal and a sliding door for easy ingress/egress.

**61 Single unit straight truck/Cab chassis (4,536 kgs ≤ GVWR ≤ 8,845 kgs)**

describes a non-articulated truck designed to carry cargo. This vehicle can be described as a cab chassis or a cut away. The gross vehicle weight rating of the vehicle must exceed 4,536 kilograms and be less than or equal to 8,845 kilograms.

**62 Single unit straight truck (8,845 kgs ≤ GVWR ≤ 11,793 kgs)**

describes a non-articulated truck designed to carry cargo. The gross vehicle weight rating of the vehicle must exceed 8,845 kilograms and be less than or equal to 11,793 kilograms.

**63 Single unit straight truck (> 11,793 kgs GVWR)**

describes a non-articulated truck designed to transport cargo with a gross vehicle weight rating in excess of 11,793 kilograms. Use this attribute if it is known that the GVWR of a single unit straight

truck is greater than 4,536 kilograms but there is insufficient data to specify the type of single unit truck.

**64 Single unit straight truck, GVWR unknown**

is used when the transport vehicle is a single unit straight truck but the GVWR is unknown.

**65 Medium/heavy truck based motorhome**

describes a recreational vehicle mounted on a single unit medium/heavy truck chassis.

Body Type (cont'd)

Page 11 of 13

**67 Truck-tractor with no cargo trailer**

describes a fifth wheel equipped tractor/trailer power unit with no trailer attached.

**68 Truck-tractor pulling one trailer**

describes a fifth wheel equipped tractor (*i.e.*, power unit of a tractor/trailer combination) pulling one semi-trailer.

**69 Truck-tractor pulling two or more trailers**

describes a fifth wheel equipped tractor (*i.e.*, power unit of a tractor/trailer combination) pulling a semi-trailer plus one or more trailers. These additional trailers may be attached with a standard hitch or a converter dolly (for semi-trailers).

**70 Truck-tractor (unknown if pulling trailer)**

is used when the vehicle is known to be a truck-tractor, but it is unknown if a trailer was being towed or if more than one trailer was being towed.

**78 Unknown medium/heavy truck type**

is used when the only available information indicates a truck of medium/heavy size.

**79 Unknown truck type (light/medium/heavy)**

is used when it is known that this vehicle is a truck, but there is insufficient data to classify the vehicle further.

**Motored Cycles (Does Not Include All Terrain Vehicles/Cycles)****80 Motorcycle**

is used when the vehicle is a two-wheeled open (*i.e.*, no enclosed body) vehicle propelled by an internal combustion engine. Motorcycles equipped with a side car also take this attribute.

**81 Moped (motorized bicycle)**

is used when the vehicle is a motorized bicycle capable of moving either by pedaling or by an internal combustion engine.

**82 Three-wheel motorcycle or moped**

is used when the vehicle is a three-wheeled open vehicle propelled by an internal combustion engine or a three-wheeled motorized bicycle capable of moving either by pedaling or by an internal combustion engine.

**88 Other motored cycle (minibike, motor scooter)**

is used when the vehicle in question does not qualify for attributes **Motorcycles, moped, three wheeled motorcycle or moped** (*e.g.*, motor scooter).



Body Type (cont'd)

Page 12 of 13

**89 Unknown motored cycle type**

is used when it is known that the vehicle is a motored cycle, but no further data is available.

**Other Vehicles**

Other Vehicles describe all motored vehicles that are designed primarily for off-road use.

**90 ATV (All-Terrain Vehicle) and ATC (All-Terrain Cycle)**

is used for off-road recreational vehicles which cannot be licensed for use on public roadways.

ATVs have 4 or more wheels and ATCs have 2 or 3 wheels. Generally, the tires have low pressure and wide profile (*i.e.*, flotation/balloon).

**91 Snowmobile**

refers to a vehicle designed to be operated over snow propelled by an internal combustion engine.

**92 Farm equipment other than trucks**

refers to farming implements other than trucks propelled by an internal combustion engine (*e.g.*, farm tractors, combines, etc.).

**93 Construction equipment other than trucks**

refers to construction equipment other than trucks propelled by an internal combustion engine (*e.g.*, bulldozer, road grader, etc.).

**94 Low Speed Vehicles(LSV)/Neighborhood Electric Vehicles (NEV)**

refers to a vehicle that is designed for travel on secondary roads with speed limits equal to or less than 35 mph. LSVs can sometimes resemble golf carts but differ in that they must adhere to Federal Motor Vehicle Safety Standard (FMVSS) 500. Provisions of FMVSS 500 include the following:  
The Vehicle must have:

- Four wheels
- Top speed of at least 20 mph, but it cannot exceed 25 mph
- GVWR less than 3,001 pounds
- Head, turn signal and tail lamps
- Reflex reflectors
- Parking brake
- Rear view mirrors
- Windshield
- Safety belts
- Seventeen (17) character VIN

Body Type (cont'd)

Page 13 of 13

**97 Other vehicle type**

is used when the motorized vehicle in question does not qualify for **Construction equipment other than trucks, Farm equipment other than trucks, Snowmobile, ATV (All-Terrain Vehicle) and ATC (All-Terrain Cycle)** (*e.g.*, go-cart, dune buggy, "kit" car, etc.).

**Unknown Vehicle Type**

Unknown Vehicle Type describes all motored vehicles where the body type cannot be differentiated among a light vehicle type, bus, medium/heavy truck, motored cycle, or any other motored vehicle type.

**99 Unknown body type**

is used when there is no available information regarding the type of vehicle. This lack of information prohibits the accurate classification of this vehicle within one of the preceding attributes.

**[CLASS OF VEHICLE]**

**Screen Name:** Class of Vehicle

**SAS Data Set:** N/A

**SAS Variable:** N/A

**Oracle Name:** *VEHICLE.PICKVEHICLECLASS*

**Element Attributes:**

Oracle	SAS	
1	1	Subcompact/mini (wheelbase < 254 cm)
2	2	Compact (wheelbase ≥ 254 but < 265 cm)
3	3	Intermediate (wheelbase ≥ 265 but < 278 cm)
4	4	Full size (wheelbase ≥ 278 but < 291 cm)
5	5	Largest (wheelbase ≥ 291 cm)
9	9	Unknown passenger car size
14	14	Compact utility vehicle
15	15	Large utility vehicle (≤ 4,536 kgs GVWR)
16	16	Utility station wagon (≤ 4,536 kgs GVWR)
19	19	Unknown utility type
20	20	Minivan (≤ 4,536 kgs GVWR)
21	21	Large van (≤ 4,536 kgs GVWR)
24	24	Van based school bus ( ≤ 4,536 kgs GVWR)
28	28	Other van type (≤ 4,536 kgs GVWR)
29	29	Unknown van type ( ≤ 4,536 kgs GVWR)
30	30	Compact pickup truck (≤ 4,536 kgs GVWR)
31	31	Large pickup truck (≤ 4,536 kgs GVWR)
38	38	Other pickup truck (≤ 4,536 kgs GVWR)
39	39	Unknown pickup truck type (≤ 4,536 kgs GVWR)
45	45	Other light truck (≤ 4,536 kgs GVWR)
48	48	Unknown light truck type ( ≤ 4,536 kgs GVWR)
49	49	Unknown light vehicle type
50	50	School bus (excludes van based) (> 4,536 kgs GVWR)
58	58	Other bus (> 4,536 kgs GVWR)
59	59	Unknown bus type
60	60	Truck (> 4,536 kgs GVWR)
67	67	Tractor without trailer
68	68	Tractor - trailer(s)
78	78	Unknown medium/heavy truck type
79	79	Unknown light/medium/heavy truck type
80	80	Motored cycle

Class of Vehicle (cont'd)

Page 2 of 5

Oracle	SAS	
90	90	Other vehicle
99	99	Unknown

**Source:** This variable is derived from application inputs from the GV form/Vehicle and Specifications Tab

**Remarks:**

The Passenger Car Classification Subcommittee, A3B11(1), of the Transportation Research Board, Traffic Records and Accident Analysis Committee, A3B11, assessed size based on the vehicle wheelbase. The guidelines for this classification can be found in the report entitled Recommended Definitions for Passenger Car Size Classification by Wheelbase and Weight, August 1984 by the previously mentioned subcommittee. This variable is the same variable that appears in the Identification section of the Vehicle Tab on the General Vehicle Form and Vehicle Exterior Form.

## Passenger Vehicles

**Subcompact/mini (wheelbase < 254 cm)**

Choose based upon wheelbase.

**Compact (wheelbase  $\geq$  254 but < 265 cm)**

Choose based upon wheelbase.

**Intermediate (wheelbase  $\geq$  265 but < 278 cm)**

Choose based upon wheelbase.

**Full size (wheelbase  $\geq$  278 but < 291 cm)**

Choose based upon wheelbase.

**Largest (wheelbase  $\geq$  291 cm)**

Choose based upon wheelbase.

**Unknown passenger car size**

is used when it is known that a vehicle is a passenger car but the wheelbase is unknown.

## Utility Vehicles

**Compact utility vehicle**refers to vehicle models defined as **Compact utility** under Body Type. Use this attribute if the size of the utility vehicle is unknown.

**Large utility vehicle (<= 4,536 kgs GVWR)**

refers to vehicle models defined as **Large utility** under Body Type. Refers to full-size multipurpose vehicles primarily designed around a shortened pickup truck chassis. While generally a station wagon body style, some models are equipped with a removable top.

**Utility station wagon (<= 4,536 kgs GVWR)**

refers to vehicle models defined as **Utility station wagon** under Body Type. Refers primarily to a pickup truck based chassis enlarged to a station wagon.

**Unknown Utility type**

is defined as **Utility, unknown body type** under Body Type. This attribute is used when it is known that the vehicle is a utility vehicle, but there is insufficient data to determine the specific type.

## Van Based Vehicles

**Minivan (<= 4536 kgs. GVWR)**

Refers to vehicle models defined as **Minivan** under Body Type. Refers to down-sized passenger or cargo vans.

**Large van (<= 4536 kgs. GVWR)**

Refers vehicle models defined as **Large van** under Body Type. Refers to a standard size cargo or passenger van.

**Van based school bus (<= 4,536 kgs GVWR)**

is a passenger van designed to carry students (passengers) to and from educational facilities and/or related functions. The vehicles are characteristically painted yellow and clearly identified as school buses. Use this attribute regardless of whether the vehicle is owned by a school system or a private company. Van based school buses converted for other uses (e.g., church bus) also take this attribute refers to vehicles defined as **Van based school bus** under Body Type.

**Other van type (<= 4,536 kgs GVWR)**

refers to vehicle models defined as Step van or walk-in van, Van based motorhome, Van based other bus and code Other van type under Body Type.

**Unknown van type (<= 4,536 kgs GVWR)**

is used when it is known that this vehicle is a light van, but its specific type cannot be determined. Refers to vehicles described as **Unknown van type** under Body Type.

Class of vehicle (cont'd)

Page 4 of 5

## Pickup Trucks

**Compact pickup truck**

refers to vehicle models defined as attributes of **Compact pickup truck** in Body Type. Used to describe a pickup truck having a width of 178 centimeters or less.

**Large pickup truck**

refers to vehicle models defined as **Large pickup truck** under Body Type. Used to describe a pickup truck having a width greater than 178 centimeters.

**Other pickup truck (<= 4536 kgs GVWR)**

refers to vehicle models defined as **Pickup with slide-in camper** and **Convertible pickup** under Body Type.

**Unknown pickup truck (<= 4536 kgs GVWR)**

refers to vehicle models defined as **Unknown pickup style light conventional truck type** under Body Type.

**Other light truck (<= 4536 kgs GVWR)**

refers to vehicle models defined as **Cab, chassis based (includes rescue vehicles, light stake, dump, and tow truck), Truck based panel, Light truck based motorhome (chassis mounted), and Other light conventional truck type** under Body Type.

**Unknown light truck type**

refers to vehicle models defined as **Unknown light truck type** under Body Type.

**Unknown light vehicle type (automobile, utility, van, or light truck)**

refers to vehicle models defined as **Unknown light vehicle type (automobile, utility, van, or light truck)** under Body Type.

## Bus

**School bus (excludes van based) (> 4536 kgs GVWR)**

refers to those vehicle models defined as **School bus (designed to carry students, not cross country or transit)** under Body Type.

**Other bus (>4,536 kgs GVWR)**

describes those vehicle models included in **Other bus type (e.g., transit, intercity, bus based motorhome)** under Body Type.

**Unknown bus type**

refers to those vehicle models described as **Unknown bus type** under Body Type.

Class of vehicle (cont'd)

Page 5 of 5

## Medium/Heavy Truck

**Truck (> 4,536 kgs GVWR)**

is defined under Body Type, as **Step van (>4,536 kgs GVWR)**, **Single unit straight truck (4,536 kgs < GVWR <= 8,845)**, **Single unit straight truck (8,845 kgs < GVWR <= 11,793)**, **Single unit straight truck (>11,793 kgs GVWR)**, **Single unit straight truck, GVWR unknown** and **Medium/heavy truck based motorhome**.

**Tractor without trailer**

refers to **Truck-tractor with no cargo trailer** under Body Type.

**Tractor-trailer(s)**

is defined in attributes **Truck-tractor pulling one trailer**, **Truck-tractor pulling two or more trailers** and **Truck-tractor (unknown if pulling trailer)** under Body Type.

**Unknown medium/heavy truck type)**

is used when the only available information indicates a truck of medium/heavy size. Refer to **Unknown medium/heavy truck type** under Body Type.

**Unknown truck type (light/medium/heavy)**

Refers to those vehicles described by **Unknown truck type (light/medium/heavy)** under Body Type.

## Motorcycle

**Motored cycle**

refers to Body Type, **Motorcycle**, **Moped (motorized bicycle)**, **Three-wheel motorcycle or moped**, **Other motored cycle (minibike, motorscooter)** and **Unknown motored cycle type**.

**Other vehicle**

refers to all vehicles described by **ATV (All-Terrain Vehicle)** and **ATC (All-Terrain Cycle)**, **Snowmobile**, **Farm equipment other than trucks**, or **Other vehicle type** under Body Type.

**Unknown**

is used when there is a lack of information regarding the type of vehicle. This lack of information prohibits the accurate classification of this vehicle using one of the preceding codes. This attribute is equivalent to Body Type, **Unknown body type**.

**VEHICLE IDENTIFICATION NUMBER (VIN)**

**Screen Name:** Identification--Identification Number

**SAS Data Set:** *GV*

**SAS Variable:** *VIN*

**Oracle Name:** *VEHICLE.VIN*

**Element Attributes:**

[11 character field in SAS]

000000000000000000

Enter the entire or partial VIN, left justify

999999999999999999

000000000000 VIN not required on vehicle

**Source:** Primary source is vehicle inspection; a secondary source is the police report.

**Remarks:**

If a vehicle is inspected, the VIN must be obtained from the vehicle. The PAR may be used to obtain a VIN when a vehicle inspection is not obtained (*i.e.*, non-tow CDS applicable *and* WinSMASH is not applicable; or Body Category, equals **Buses, Medium/Heavy Trucks, Motorcycles, or Other Vehicles.**

Enter the entire VIN; leave "**blank**" any column which does not have a VIN character. If part of the VIN is missing or not decipherable, leave the missing or decipherable column blank. Use VIN Assist to check the VIN. Additionally, in NASSMAIN the VIN can be checked on the GV Form by going to *Process / VIN Check Routine.*

**000000000000000000**

enter a "0" in each position for vehicles not required to have a VIN (e.g., go cart).

**999999999999999999**

if the entire VIN is unknown, or missing enter a "9" in each position.

If the vehicle is a motor home or school bus, the vehicle chassis VIN is coded and the secondary manufacturer's number should be annotated if indicated on the PAR.



Vehicle Identification Number (cont'd)

Page 2 of 2

If the vehicle is manufactured by the Ford Motor Company (prior to 1980) and the VIN begins or ends with a script, "f", the "f" is not entered. Proceed to the next character, as in the example below.

**VIN:**        *f*3 U 6 2 S 1 0 0 9 3 2 *f*  
**CODE:**        3 U 6 2 S 1 0 0 9 3 2

In addition, if any hyphens, periods, or blank spaces are contained in the string of alphanumeric characters, ignore them as in the example below.

**VIN:**        S M - E 3 0 7 6 4 2 1  
**CODE:**        S M E 3 0 7 6 4 2 1

## VEHICLE SPECIAL USE

Page 1 of 3

Screen Name: Vehicle Special Use

SAS Data Set: **GV**SAS Variable: **VEHUSE**Oracle Name: **VEHICLEPRECRASH.PICKSPECIALUSE**

## Element Attribute:

Oracle	SAS	
0	0	No special use
1	1	Taxi
2	2	Vehicle used as school bus
3	3	Vehicle used as other bus
4	4	Military
5	5	Police
6	6	Ambulance
10	7	Fire Truck
11	8	Emergency Services Vehicle
9	9	Unknown

**Source:** Researcher determined; primary source is the police report; secondary sources include vehicle inspection, and interviewees.

**Remarks:****No special use**

is used when no source indicates or implies that this vehicle was applicable to any of the special uses listed below.

**Taxi, Vehicle used as school bus, and Vehicle used as other bus**

are "*this trip*" specific. The vehicle must be "on duty" as either a taxi or as a bus. External identification on the vehicle as a bus or taxi is not sufficient to determine its special use.

**Taxi**

is used when this vehicle was being used during this trip (at the time of the crash) on a "fee-for-hire" basis to transport persons. Most of these vehicles will be marked and formally registered as taxis; however, vehicles which are used as taxis, even though they are not registered (*e.g.*, "Gypsy Cabs"), are included here. ***Taxis and drivers which are off-duty*** at the time of the crash ***are not included***.

**Vehicle used as school bus**

is used if this motor vehicle (**Body Type**, need not equal **School Bus**) satisfies all of the following criteria:

- externally identifiable to other traffic units as a school/pupil transport vehicle. The vehicle may be equipped with flashing lights and/or a sway stop arm, and traffic may be required to stop for the vehicle when occupants enter or exit;
- operated, leased, owned, or contracted by a public or private school-type institution;
- whose occupants, if any, are associated with the institution; and,
- the vehicle is in operation at the time of the crash to and from the school or on a school-sponsored activity or trip.

**Vehicle used as other bus**

is used when this motor vehicle is designed for transporting more than ten persons and does not satisfy all of the above criteria of a school bus.

**Military, Police, Ambulance, and Fire truck or car**

are considered to be in use at all times. Special use means "**in use**" and not necessarily emergency use. External identification to the normal driving public is the sole criterion.

**Military**

is used for any vehicle which is owned by any of the Armed Forces regardless of body type. This attribute includes:

- military police vehicles;
- military ambulances;
- military hearses; and
- military fire vehicles

**Police**

refers to a vehicle equipped with police emergency devices (lights and siren) that is owned or subsidized by any local, county, state or federal government entity. The police vehicle is presumed to be in special use at all times, although not necessarily in "emergency use." Vehicles not owned by a government entity that are used by law enforcement officers (e.g. undercover) are excluded.

**Ambulance**

is used for any readily identifiable (lights or markings) vehicles designed to transport sick or injured persons. The ambulance is presumed to be in special use at all times, although not necessarily in "emergency use."

**Fire truck**

is used for any readily identifiable (lights or markings) vehicles specially designed and equipped to respond to fire, hazmat, medical, and extrication incidents. This attribute includes medium and heavy vehicles such as engines, pumpers, ladder, platform aerial apparatus, heavy rescue vehicles, water tenders or tankers, brush or wilderness firefighting vehicles, etc. Privately owned vehicles, which are not in authorized use, even if equipped with lights, do not qualify (the volunteer firefighter's vehicle).

**Emergency Services Vehicle**

is used for any readily identifiable (lights or markings) vehicles that do not meet the criteria for Ambulance or Fire Truck and are specially designed and equipped to respond to fire, hazmat, medical, and extrication incidents. This attribute includes light vehicles such as sedans, vans, SUVs, pick-ups, trucks, motorcycles, etc. Privately owned vehicles, which are not in authorized use, even if equipped with lights, do not qualify (the volunteer firefighter's vehicle).

**Unknown**

is used when no information is available to determine special use for this trip (e.g., a hit-and-run vehicle).

**TRANSPORT STATUS**

**Screen Name:** Transport Status?

**SAS Data Set:** *GV*

**SAS Variable:** *TRANSTAT*

**Oracle Name:** *VEHICLE.INTRANSPORT*

**Element Attributes:**

Oracle	SAS	
1	1	In Transport
0	2	Not in transport
2	3	Working vehicle

**Range:**

**Source:** Researcher determined

**Remarks:**

This is researcher determined and may not necessarily agree with the police report.

If the PAR has conflicting information regarding the vehicle’s transport status, assume the vehicle is in-transport. For example: If the coded box indicates the vehicle was legally parked but the narrative states the vehicle was illegally parked, then consider this vehicle as in-transport.

If there is any doubt as to whether the vehicle is in-transport, notify your Zone Center immediately.

If the PAR is unclear whether the motor vehicle is actually in the act of performing work at the time of the crash, the default is to consider the motor vehicle as **not** working. Careful attention must be taken to review the narrative, diagram and coded boxes, for an accurate determination.

**In Transport**

Is selected when it is determined that the vehicle is in-transport. This means the vehicle is in motion on a Trafficway or any part of the vehicle is within the boundaries of the roadway.

Examples of In Transport vehicles seen in NASS:

1. A police vehicle used to indicate the roadway is closed due to a previous crash or the roadway is impassable because of a pothole or a tree fell across the roadway is

## Transport Status (cont'd)

Page 2 of 3

considered to be in transport. The portion of the roadway past the police vehicle is considered to be closed; that is, outside the trafficway.

2. A cement truck depositing its load for a homeowner's driveway or walkway.
3. Friendly neighbor using his pickup truck to plow the roadway in their neighborhood.
4. A passenger vehicle located partially on the roadway and the shoulder.

**Not In-Transport**

Is selected when it is determined that the vehicle is not in-transport. Not in-transport vehicles are defined as:

1. Stationary vehicles outside the boundaries of the roadway.
2. Vehicles in motion outside the trafficway.

## Examples of Not In-Transport Vehicles:

1. Lawn service truck spraying fertilizer, etc across homeowner's lawn.
2. Disabled passenger car pulled onto shoulder of roadway.
3. Minivan parked on the street during the hours parking is allowed.
4. Tractor plowing the corn field loses control and strikes the barn.

**Working Vehicle**

Is selected when it is determined that the vehicle was in the act of performing highway construction, maintenance or utility work when it became involved in the crash. This "work" may be located within or outside the trafficway boundaries, including portions of the trafficway closed for construction. This code does not include private construction/maintenance vehicles, or vehicles such as garbage trucks, delivery trucks, taxis, emergency vehicles, tow trucks, etc.

## Examples of Working Vehicles include:

1. Asphalt/steam roller working in a highway construction zone paving the roadway or flattening dirt.
2. State highway maintenance crew painting lane lines on the road, mowing grass on the roadside or median, repairing potholes, removing debris from the roadway, etc.
3. Utility truck or a "cherry picker", performing maintenance on power lines along the roadway or maintaining a traffic signal.
4. A private excavating company contracted by the State digging the foundation for a new overpass.
5. A state, county, or privately owned snow plow, plowing ice/snow as part of a highway maintenance activity.
6. Street sweeper sweeping the street.
7. A vehicle in a mobile work convoy displaying arrow boards or other signaling devices warning motorists of the work activity.

Transport Status (cont'd)

Page 3 of 3

8. A law enforcement vehicle which is participating strictly in a stationary construction or mobile maintenance activity as a traffic slowing, control, signaling or calming influence.

Working vehicles do not include personal motor vehicles performing a “neighborly” activity (such as plowing the neighborhood streets). Additionally, vehicles not specifically contracted to AND in the act of performing highway construction, maintenance or utility work are excluded.

When the vehicle is not in the act of performing “work” and involved in a crash, these highway construction, maintenance or utility vehicles are not working vehicles and can be:

1. In-transport when in motion or stopped on a roadway; or
2. Not in-transport when stopped off the roadway.

**Examples:**

Example #1: A vehicle removing ice/snow from the roadway is involved in a crash with a motor vehicle off the roadway. Does this crash qualify for NASS?

Answer: The vehicle is considered to be a working vehicle and therefore, not in-transport. The motor vehicle off the roadway is also considered to be not in-transport. Therefore, this crash does not qualify for the NASS.

Example #2: A highway maintenance vehicle is removing ice/snow from the roadway and strikes and kills a pedestrian. Does this crash qualify for NASS?

Answer: This crash does not qualify because the highway maintenance vehicle is considered a working motor vehicle and by definition is not in-transport as it was doing work at the time of the incident.

Example #3: A highway maintenance vehicle removing ice/snow from the roadway strikes a passenger vehicle also traveling on the roadway. The passenger vehicle sustains disabling damage and was towed from the scene of the crash. Does this crash qualify for NASS?

Answer: This crash qualifies because the passenger vehicle was in-transport and towed due to damage. This is a single vehicle crash.

Example #4: A passenger vehicle traveling along the roadway loses control and strikes a tractor plowing the corn field. Does this qualify for NASS?

Answer: This crash does indeed qualify for NASS. This is a single vehicle crash where the only vehicle involved in the crash is the passenger vehicle.

**CURB WEIGHT**

**Screen Name:** Weight--Curb Weight

**SAS Data Set:** *VEHSPEC*

**SAS Variable:** *CURBWGT*

**Oracle Name:** *VEHICLE.CURBWEIGHT*

**Element Attributes:**

999999 Curb weight of vehicle (kgs)  
Unknown

**Range:** 450 – 100,000

**Source:** Researcher determined

**Remarks:**

Enter this vehicle's curb weight.

Do not confuse the rated Gross Vehicle Weight Rating (GVWR) with the curb weight since it is likely to be significantly greater than the curb weight.

"Vehicle" is defined in this variable to mean the same vehicle identified under **Body Type**.

If the **vehicle model** is known, but the engine size is unknown (*e.g.*, 6 or 8 cylinders), code the average between the high and low curb weights for the model and annotate that the "average" was reported.

When the vehicle specifications do not report the vehicle weight with the proper engine size, adjustments must be made. First, try to determine the weight differences from the vehicle specifications. If the weight difference cannot be determined from the specifications, then adjust as follows: 8 cyl. to 6 cyl. - subtract 100 lbs/45 kilograms; 6 cyl. to 4 cyl. - subtract 75 lbs/34 kilograms.

Add 100 lbs/45 kilograms to the shipping weight to obtain a curb weight on all CDS applicable vehicles.

Towed trailing units are considered cargo weight and not included in the vehicle curb weight

**Unknown**

is selected when the curb weight of this vehicle cannot be determined.



**SOURCE OF CURB WEIGHT INFORMATION**

**Screen Name:** Curb Weight Source

**SAS Data Set:** *VEHSPEC*

**SAS Variable:** *CURBSRC*

**Oracle Name:** *VEHICLE.PICKCURBWTSOURCE*

**Element Attributes:**

Oracle	SAS	
9999	0	[Curb weight unknown]
1	1	AAMA
2	2	Automotive News
3	3	Branham Automobile Reference Book
4	4	Gasoline Truck, Import, Truck and Diesel Truck Index
6	5	Canadian Specifications
5	8	Other (specify)

**Source:** See Remarks

**Remarks:**

If the specification is not available in the sources listed below, then the automated Canadian specifications may be used for this variable.

If no other information is available, data from brochures obtained from vehicle dealers may be used. In addition, manufacturer on-line specifications and internet resources, such as, carsdirect.com or Edmunds.com maybe used with Zone Center approval. This will be entered under the “**Other**” attribute. This should then be listed in the “**Specify**” field.

Annotate the source used in the space provided on the General Vehicle Form/Vehicle tab for this variable.

The sources for obtaining curb weight information are listed below:

*Passenger Vehicle Specifications*

**American Automobile Manufacturers Association (AAMA)  
of the U.S., Inc.**

300 New Center Building  
Detroit, Michigan 48202

Source of Curb Weight Information (cont'd)

Page 2 of 2

*Automotive News*

**Crain Automotive Group, Inc.**

965 East Jefferson Avenue

Detroit, Michigan 48207

*Branham Automobile Reference Book*

**Branham Publishing Company**

Post Office Box 1948

Santa Monica, California 90406-1948

*Gasoline Truck Index, Import Truck Index, and  
Diesel Truck Index*

**Truck Index, Inc.**

Post Office Box 10291

Santa Anna, California 92711

**CARGO WEIGHT**

**Screen Name:** Weight--Cargo Weight

**SAS Data Set:** *GV*

**SAS Variable:** *CARGOWGT*

**Oracle Name:** *VEHICLE.CARGOWEIGHT*

**Element Attributes:**

Oracle	SAS	
	8888	Cargo weight of vehicle (kgs) [Non CDS vehicle]
-9999	9999	Unknown

**Source:** Researcher determined — inputs include Vehicle Inspection, Interview, PAR, Tow Yard Operator

**Remarks:**

If Towed Trailing Unit, is Yes – towed trailing unit, then the weight of the trailer and its cargo is coded here. Cargo may also be located in the passenger compartment area and/or trunk.

If there is no cargo then enter the value as zero.

Do not include the weight of the occupants in the cargo weight. The weight of the occupants is included (along with cargo and vehicle curb weight) as a component of the single value which represents the vehicle’s combined weight in the integrated WinSMASH Program, if used.

Cargo weight includes optional add on equipment. Code cargo weight only if the total exceeds 100 lbs. Examples are as follows:

- Includes:
  - Tools and tool box(es)
  - Construction equipment
  - Lumber
  - Luggage

- Excludes:
  - Weight of occupants

**Unknown**

is selected if the cargo weight is unknown or if it is unknown if there is cargo in the vehicle.

**SOURCE OF CARGO WEIGHT INFORMATION**

**Screen Name:** Weight--Cargo Weight Source

**SAS Data Set:** *GV*

**SAS Variable:** *CARGOSRC*

**Oracle Name:** *VEHICLE.PICKCARGOWTSOURCE*

**Element Attributes:**

Oracle	SAS	
-9999	0	[Cargo weight unknown]
1	1	Vehicle Inspection
2	2	Interview
3	3	PAR
4	4	Tow Yard Operator
-8887	7	[Non CDS vehicle]
5	8	Other (specify)

**Source:** Researcher determined

**Remarks:**

This reports the source from which the cargo weight was obtained.

## INSPECTION TYPE

Page 1 of 2

**Screen Name:** Inspection - Type of Inspection

**SAS Data Set:** *GV*

**SAS Variable:** *INSPTYPE*

**Oracle Name:** *VEHCILECRASH.PICKINSPECTIONTYPE*

**Element Attributes:**

Oracle	SAS	
1	0	No inspection
2	1	Vehicle fully repaired — no damage evident
7	2	Partial inspection-Non tow
3	3	Partial inspection-other (specify)
5	5	Partial inspection-Photos only
6	6	Partial inspection-MY greater than 10 years
4	4	Complete inspection
8	8	[Non CDS vehicle]

**Source:** Researcher determined.

**Remarks:**

This variable is designed to allow users to identify cases with complete documentation of required damage data (exterior and interior).

**No inspection**

is selected when neither a complete nor a partial inspection of this vehicle was obtained, irrespective of the reason (*e.g.*, refusal, not required, etc.)

**Vehicle fully repaired — no damage evident**

is selected when a vehicle is inspected, but is completely repaired and no exterior or interior damage data is available.

**Partial Inspection-Non Tow**

is used when the vehicle is a non-towed CDS applicable vehicle and a complete exterior inspection was obtained. This includes vehicles older than 10 years that are not towed.

Inspection Type (cont'd)

Page 2 of 2

**Partial inspection-Other (Specify)**

is selected when any significant aspect of the inspection is not completed. This includes inspection of partially repaired vehicles. This attribute is not used for non-towed CDS applicable vehicles where a complete exterior inspection was obtained. The reason for the partial inspection must be annotated in the "Specify" box.

If the vehicle interior is completely burned out and restraint use cannot be determined then **Partial Inspection** should be selected.

**Partial inspection-Photos only**

is selected when outside source photographs are used. For further information refer to the CDS Digital Photography Guidelines Manual.

**Partial inspection-MY greater than 10 years**

is selected when the vehicle is older than the current data year minus 9 years and was towed. If the model year can not be determined consider the model year as less than 10 years old.

**Complete inspection**

is selected when both the exterior and the interior of the unrepaired vehicle were inspected and all applicable measurements and photographs were obtained.

**DATE OF INSPECTION**

**Screen Name:** Inspection-Date of Inspection

**SAS Data Set:** N/A

**SAS Variable:** N/A

**Oracle Name:** *VEHICLECRASH.INSPECTIONDATE*

**Element Attributes:**

Date that vehicle was inspected

**Source:** Researcher determined.

**Remarks:**

The inspection date is the date when a majority of the inspection is complete. This does not count unsuccessful attempts to locate the vehicle.

SPECIFICATIONS

General Vehicle Form, Case 2007-8701-009K/ Vehicle #1

VEHICLE SPECIFICATIONS OFFICIAL RECORDS PRECRASH DRIVER ROLLOVER RECONSTRUCTION DE

TOYOTA CAMRY 2007

**Original Specifications**

Wheelbase	254	cms	Front Overhang	28	cms
Overall Length	254	cms	Rear Overhang	28	cms
Maximum Width	254	cms	Undeformed End Width	111	cms
Curb Weight	907	kgs	Engine Cylinders		
Average Track	123	cms	Displacement	3	L

Transmission

Type Of Transmission: Manual Drive Wheels: Front Wheel Drive (FWD)

Researcher's Assessment of Vehicle Disposition: Towed due to vehicle damage

Justification: io

Is This a Multi-Stage Manufactured Vehicle And/Or A Certified Altered Vehicle: No post-manufacturer modifications

Suspected Modifications:

Save Close



**WHEELBASE**

Page 1 of 2

**Screen Name:** Original Specifications—Wheelbase**SAS Data Set:** *VEHSPEC***SAS Variable:** *WHEELBAS***Oracle Name:** *VEHICLE.WHEELBASE***Element Attributes:**

Oracle	SAS	
-9999	999	Enter to the nearest centimeter. Unknown

**Range:** 100 – 650 cms**Source:** Vehicle specifications, exemplar vehicle**Remarks:**

The coding of this variable reflects the length of the vehicle's original or undamaged wheelbase to the nearest centimeter.

If the specification is not available in the sources listed below, then the automated Canadian specifications may be used for this variable.

If no other information is available, data from brochures obtained from vehicle dealers may be used. In addition, manufacturer on-line specifications and internet resources, such as, carsdirect.com or Edmunds.com maybe used with Zone Center approval.

The sources for obtaining curb wheelbase information are listed below:

*Passenger Vehicle Specifications***American Automobile Manufacturers Association (AAMA)  
of the U.S., Inc.**

300 New Center Building  
Detroit, Michigan 48202

Wheelbase (cont'd)

Page 2 of 2

*Automotive News*

**Crain Automotive Group, Inc.**

965 East Jefferson Avenue

Detroit, Michigan 48207

*Branham Automobile Reference Book*

**Branham Publishing Company**

Post Office Box 1948

Santa Monica, California 90406-1948

*Gasoline Truck Index, Import Truck Index, and  
Diesel Truck Index*

**Truck Index, Inc.**

Post Office Box 10291

Santa Anna, California 92711

If written vehicle specifications cannot be found, after consultation of the zone center, the researcher may take the measurements from an exemplar vehicle.

**Unknown**

is used when this vehicle's original wheelbase cannot be determined.

**OVERALL LENGTH**

**Screen Name:** Original Specifications—Overall Length

**SAS Data Set:** *VEHSPEC*

**SAS Variable:** *OVERALL*

**Oracle Name:** *VEHICLE.OVERALLLENGTH*

**Element Attributes:**

Oracle	SAS	
		Enter to the nearest centimeter
-9999	9999	Unknown

**Range:** 100 – 850 cms

**Source:** Vehicle specifications, exemplar vehicle

**Remarks:**

Enter the overall length of the vehicle, as determined from source materials, to the nearest centimeter.

Any add-on equipment is excluded from the overall length of the vehicle (i.e., a pick-up with an after-market bumper added).

**Unknown**

is used when this vehicle's original overall length cannot be determined.

**MAXIMUM WIDTH**

**Screen Name:** Original Specifications—Maximum Width

**SAS Data Set:** *VEHSPEC*

**SAS Variable:** *MAXWIDTH*

**Oracle Name:** *VEHICLE.MAXWIDTH*

**Element Attributes:**

Oracle	SAS	
		Enter to the nearest centimeter
-9999	999	Unknown

**Range:** 100 – 350 cms

**Source:** Vehicle specifications, exemplar vehicle

**Remarks:**

Enter the overall/maximum width of the vehicle, as determined from source materials, to the nearest centimeter.

**Unknown**

is used when this vehicle's original overall width cannot be determined.

**CURB WEIGHT**

**Screen Name:** Original Specifications—Curb Weight

**SAS Data Set:** *VEHSPEC*

**SAS Variable:** *CURBWGT*

**Oracle Name:** *VEHICLE.CURBWEIGHT*

**Element Attributes:**

Oracle	SAS	
		Curb weight of vehicle (kgs)
-9999	999999	Unknown

**Range:** 450 – 6,500

**Source:** Researcher determined

**Remarks:**

Enter this vehicle's curb weight.

Do not confuse the rated Gross Vehicle Weight Rating (GVWR) with the curb weight since it is likely to be significantly greater than the curb weight.

"Vehicle" is defined in this variable to mean the same vehicle identified under Body Type.

If the vehicle model is known, but the engine size is unknown (*e.g.*, 6 or 8 cylinders), code the average between the high and low curb weights for the model and annotate that the "average" was reported.

When the vehicle specifications do not report the vehicle weight with the proper engine size, adjustments must be made. First, try to determine the weight differences from the vehicle specifications. If the weight difference cannot be determined from the specifications, then adjust as follows: 8 cyl. to 6 cyl. - subtract 100 lbs/45 kilograms; 6 cyl. to 4 cyl. - subtract 75 lbs/34 kilograms.

If a source material reports "shipping weight" add 100lb/45 kilograms to obtain a curb weight on all CDS applicable vehicles.

Towed trailing units are considered cargo weight and not included in the vehicle curb weight.

**Unknown**

is entered when the curb weight of this vehicle cannot be determined.

**AVERAGE TRACK WIDTH**

**Screen Name:** Original Specifications—Average Track

**SAS Data Set:** *VEHSPEC*

**SAS Variable:** *ORIGAVTW*

**Oracle Name:** *VEHICLE.AVGTRACK*

**Element Attributes:**

Oracle	SAS	
		Code to the nearest centimeter
-9999	999	Unknown

**Range:** 100-200, 999

**Source:** Vehicle specifications, undamaged measurements

**Remarks:**

Enter the average track width of the vehicle to the nearest centimeter.

If vehicle specifications cannot be obtained, and there are no post manufacture modifications, and there is no significant damage to the axles, then you can get the value from the case vehicle. Measure both undamaged track widths on the vehicle and record the average.

If an axle is damaged such that an average value cannot be determined, use the measurement of the undamaged axle as the average encoded value.

If both axles are significantly damaged record the value from an exemplar vehicle.

If the vehicle is equipped with dual rear wheels (*i.e.*, some full-size pickup trucks) the track width is measured from the center of the space between the wheels on both sides.

**Unknown**

is used in the following situations:

- The axles are significantly damaged and there are no specifications available for this vehicle, and an exemplar vehicle was not measured.
- The axle is significantly damaged *and* there were post-manufacture modifications that would alter the track width.
- The measurements were not obtained from this vehicle or an exemplar vehicle and there are no specifications available.

**FRONT OVERHANG**

**Screen Name:** Original Specifications—Front Overhang

**SAS Data Set:** *VEHSPEC*

**SAS Variable:** *FTOVHANG*

**Oracle Name:** *VEHICLE.FRONTOVERHANG*

**Element Attributes:**

Oracle	SAS	
		Code to the nearest centimeter
-9999	999	Unknown

**Range:** 25-150, 999

**Source:** Vehicle specifications, undamaged measurements or an exemplar vehicle

**Remarks:**

Enter the front overhang, as determined from source materials, of the vehicle to the nearest centimeter.

NOTE: the researcher should record, on the sketch page, the front and rear stringline measurements. These measurements will closely represent the original overhang measurements provided a reference line was established and the axles were not moved.

This measurement is required for all end impacts. If it is a side impact and the front overhang is not available use **Unknown**.

**Unknown**

is used in the following situations:

- The axles are significantly damaged and there are no specifications available for this vehicle, and an exemplar vehicle was not measured.
- The axle is significantly damaged *and* there were post-manufacture modifications that would alter the front overhang.
- The measurements were not obtained from this vehicle or an exemplar vehicle and there are no specifications available.

**REAR OVERHANG**

**Screen Name:** Original Specifications—Rear Overhang

**SAS Data Set:** *VEHSPEC*

**SAS Variable:** *RROVHANG*

**Oracle Name:** *VEHICLE.REAROVERHANG*

**Element Attributes:**

Oracle	SAS	
		Code to the nearest centimeter
-9999	999	Unknown

**Range:** 25-200, 999

**Source:** Vehicle specifications, undamaged measurements or an exemplar vehicle.

**Remarks:**

Enter the rear overhang, as determined from source materials, of the vehicle to the nearest centimeter.

NOTE: the researcher should record, on the sketch page, the front and rear stringline measurements. These measurements will closely represent the original overhang measurements provided a reference line was established and the axles were not moved.

**Unknown**

is used in the following situations:

- The axles are significantly damaged and there are no specifications available for this vehicle, and an exemplar vehicle was not measured.
- The axle is significantly damaged *and* there were post-manufacture modifications that would alter the rear overhang.
- The measurements were not obtained from this vehicle or an exemplar vehicle and there are no specifications available.



**UNDEFORMED END WIDTH**

**Screen Name:** Original Specifications—Undeformed End Width

**SAS Data Set:** *VEHSPEC*

**SAS Variable:** *UNENDW*

**Oracle Name:** *VEHICLE.ENDWIDTH*

**Element Attributes:**

Oracle	SAS	
		Code to the nearest centimeter
-9999	999	Unknown

**Range:** 100-250, 999

**Source:** Vehicle inspection, or an exemplar vehicle

**Remarks:**

The undeformed end width is the undamaged dimension of the contacted end plane measured between the apex of both bumper corners.

**Unknown**

If the vehicle cannot be directly measured and an exemplar vehicle cannot be found, then enter unknown.

**ENGINE CYLINDERS**

**Screen Name:** Original Specifications—Engine Cylinders

**SAS Data Set:** *VEHSPEC*

**SAS Variable:** *ENGCYL*

**Oracle Name:** *VEHICLE.CYLINDERS*

**Element Attributes:**

Oracle	SAS	
		Code the number of cylinders
		Not Applicable
-9999	99	Unknown

**Range:** 1-14, 99

**Source:** Vehicle inspection, specifications, VIN

**Remarks:**

The coding of this variable reflects the number of cylinders in the vehicle. The information can be found in vehicle specifications. It may also be found in owner's manuals.

**Not Applicable**

is used for vehicles that do not have a combustible engine, an example is an all electric vehicle.

**Unknown**

If the number of engine cylinders cannot be determined, then enter unknown.

**ENGINE DISPLACEMENT**

**Screen Name:** Original Specifications—Engine Displacement

**SAS Data Set:** *VEHSPEC*

**SAS Variable:** *ENGDISP*

**Oracle Name:** *VEHICLE.ENGINEL*

**Element Attributes:**

Oracle	SAS	
		Code to the nearest tenth of a liter
		Not Applicable
-9999	99	Unknown

**Range:** 0-10, 99

**Source:** Vehicle inspection, specifications, VIN

**Remarks:**

The coding of this variable reflects the vehicle's engine displacement. The information can be found in vehicle specifications. It may also be found in owner's manuals, or from the vehicle inspection.

Enter the vehicle's engine displacement. It is recorded to the nearest tenth of a liter.

**Not Applicable**

is used for vehicles that do not have a combustible engine, an example is an all electric vehicle.

**Unknown**

If the displacement cannot be determined, then enter unknown.

**TYPE OF TRANSMISSION**

**Screen Name:** Type of Transmission

**SAS Data Set:** *VEHSPEC*

**SAS Variable:** *TRANS*

**Oracle Name:** *VEHICLE.PICKTRANSMISSIONCODE*

**Element Attributes:**

Oracle	SAS	
1	1	Manual
2	2	Automatic
3	9	Unknown

**Source:** Vehicle inspection

**Remarks:**

The coding of this variable reflects the type of transmission that is in the vehicle.  
This variable is being collected for use in modifying input to the WINSMASH computer program.

**Manual**

The vehicle has a manual transmission.

**Automatic**

The vehicle has an automatic transmission.

**Unknown**

It cannot be determined what type of transmission is in the vehicle.

**DRIVE WHEELS**

**Screen Name:** Drive Wheels

**SAS Data Set:** *VEHSPEC*

**SAS Variable:** *DRIVE*

**Oracle Name:** *VEHICLE.PICKDRIVEWHEELSCODE*

**Element Attributes:**

Oracle	SAS	
1	1	Front Wheel Drive
2	2	Rear Wheel Drive
3	3	Four Wheel Drive
4	4	All Wheel Drive
5	9	Unknown

**Source:** Vehicle inspection

**Remarks:**

The coding of this variable reflects the type of drive wheels power the vehicle.  
This variable is being collected for use in modifying input to the WINSMASH computer program.

**Front Wheel Drive**

In a front-wheel drive vehicle, power from the engine is transferred to the front tires.

**Rear Wheel Drive**

In a rear-wheel drive vehicle, power from the engine is transferred to the rear tires.

**4 Wheel Drive**

In a four-wheel drive vehicle, power is delivered to all four wheels only when the driver requests it.

**All Wheel Drive**

In an all-wheel drive vehicle, power is distributed to all four of the vehicle's tires, all of the time.

**Unknown**

Use this when it cannot be determined what type of drive wheels power the vehicle.

**MULTI-STAGE OR ALTERED VEHICLE**

Page 1 of 3

**Screen Name:** Is This a Multi-Stage Manufactured Vehicle And/Or A Certified Altered Vehicle?

**SAS Data Set:** *VEHSPEC*

**SAS Variable:** *ALTVEH*

**Oracle Name:** *VEHICLE.MANUFACTURERCERTMODS*

**Element Attributes:**

Oracle	SAS	
1	0	No post manufacturer modifications
2	1	Yes-post manufacturer modifications (specify)
9	9	Unknown if vehicle is modified
-8	8	[Not inspected]

**Source:** Vehicle Inspection.

**Remarks:**

Under the "Code of Federal Regulations, Title 49 - Transportation" Chapter V Part 567, Sections 567.5 and 567.7, a label certifying compliance with all Federal Motor Vehicle Safety Standards must be affixed to a multi-stage manufactured vehicle or altered (post manufactured) vehicle.

A multi-stage manufactured vehicle will generally begin as a chassis-cab (incomplete vehicle) and subsequently end up in final-stage as a pickup based utility truck (dump truck, flat bed, stake body, tow truck, etc.) or a van derivative (*i.e.*, van conversion, Hi-cube, motor home, etc.).

Altered vehicles will generally involve a major modification of basic components such as suspension, frame, power plants, etc., with work generally performed by a recognized auto body shop. The lengthening of a standard automobile chassis to create a limousine would be one example of the type of alteration which would qualify for certification.

To determine if the vehicle qualifies, locate the certification label which should include one of the following statements:

**Multi-stage vehicle**

Incomplete manufactured vehicle (chassis-cab) certification label should include the statement: "**CHASSIS-CAB MANUFACTURED BY**" or "**CHASSIS-CAB MFD. BY**".

Intermediate manufactured vehicle certification label should have the following statement: "**INTERMEDIATE MANUFACTURED BY**" or "**INTERMEDIATE MFD. BY**".

inal manufactured vehicle certification label should have the following statements:

**"MANUFACTURED BY" or "MFD. BY" and "INCOMPLETE VEHICLE MANUFACTURED BY" or "INC VEH MFD. BY".**

**Altered vehicle**

An altered vehicle certification label should include the statement: **"This vehicle was altered by (individual or corporate name) in (month and year in which alterations were completed) and as altered it conforms to all applicable Federal Motor Vehicle Safety Standards affected by the alteration and in effect in (month, year).**

These labels are generally affixed in one of the following areas on the driver's side of the vehicle:

- hinge pillar
- door-latch post
- door edge that meets the door-latch post
- left side of the instrument panel
- inward-facing surface of driver's door

**No post manufacturer modifications**

is used when this vehicle was a full-line manufactured vehicle. Full-line is interpreted as a vehicle that is completely assembled at the end of a plant assembly line of its original manufacturer. This would include vehicles which only require cosmetic additions such as additional paint, mirrors, wheels, etc., to be customer ready.

**Yes — post manufacturer modifications**

is used for multi-stage vehicles and/or altered certified vehicles. This includes vehicles which were in various stages of completion (*i.e.*, incomplete, intermediate, final).

Vehicles that are altered via "backyard modification (*i.e.*, addition of air shocks, spring spacers, cosmetic alteration including sheet metal and paint, etc.) are not identified as certified altered vehicles. Only those businesses which specialize in vehicle alterations (*i.e.*, limo body shops, etc.) where a label of alteration is required by federal regulations and is present on the vehicle are identified in this element.

***An image of the certification label(s) is essential and must be included with the case. Categorize this image in the Miscellaneous Category.***

**Unknown**

is used in the following situations.

- The vehicle fits the description of a multi-stage or altered vehicle, but the researcher was not able to view the label(s) for positive identification.
- The label(s) was removed/destroyed so a clear determination of whether the vehicle was a certified multi-stage or altered vehicle could not be made.

Multi-Stage or Altered Vehicle (cont'd)

Photograph examples:

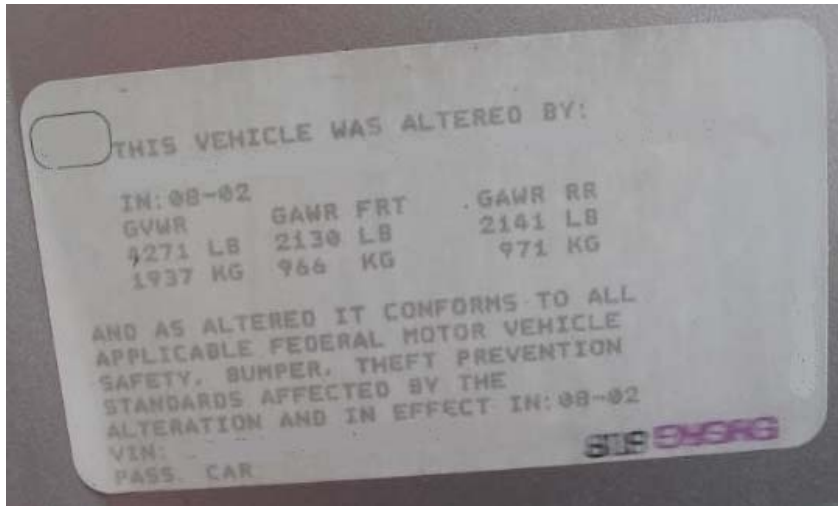



**SUSPECTED POST MANUFACTURERER MODIFICATIONS**

**Screen Name:** Suspected post manufacturer modifications

**SAS Data Set:**

**SAS Variable:**

**Oracle Name:** *VEHICLE.SUSPECTEDMODS*

**Element Attributes:**

Check Box

**Range:**

**Source:** Vehicle inspection, researcher determined

**Remarks:**

The purpose of this variable is to determine if the vehicle has been modified so that the handling and crashworthiness characteristics are affected. This is based upon a suspicion by the researcher at the time of the vehicle inspection.

Examples of modifications:

- Smaller or larger tires
- Body lift kit
- Lowered body
- Altered suspension
- Composite front body panels

Examples of modifications that are not considered:

- Changing the side rear view mirrors
- Aftermarket window tinting
- Additional lighting attached to the roof

OFFICIAL RECORDS

General Vehicle Form, Case 2007-996-900015/ Vehicle #1

VEHICLE | SPECIFICATIONS | OFFICIAL RECORDS | PRECRASH | DRIVER | ROLLOVER | RECONSTRUCTION | DELTA V | LOG | REVIEW

**Police Reported**

Tow Status: Towed due to vehicle damage

Travel Speed: 40 kmp **Posted** Speed Limit: 40 kmp

**Driver**

Driver Present?: Yes

Occupant Number: 1

PAR Alcohol Presence: No alcohol present

Alcohol Test: None Given

Test Result: Not Applicable Source: No BAC test

PAR Other Drug Present: No other drug(s) present

Other Drug Test Result: No specimen test given

Zip Code: 22306

Race: White

Ethnicity: Hispanic or Latino

Save Close

**POLICE REPORTED TOW STATUS**

**Screen Name:** Police Reported-Tow Status

**SAS Data Set:** *GV*

**SAS Variable:** *TOWPAR*

**Oracle Name:** *VEHICLE.PICKVEHICLEDISPOSITION*

**Element Attributes:**

Oracle	SAS	
0	0	Not towed due to vehicle damage
1	1	Towed due to vehicle damage
9	9	Unknown

**Source:** Police report

**Remarks:**

The tow status as indicated in this variable is the same tow status that was used in determining the case stratification.

A "**towed**" vehicle is defined as a vehicle which is removed from the crash scene other than by means of its own power. For example, a vehicle which is reported by the police as towed out of a ditch and subsequently driven away, is *not* considered a towed vehicle. A vehicle which is driven from the scene and subsequently becomes disabled due to crash-related damage, such that towing is then required, is *not* a towed vehicle (even though that towing may be reported on the police report). Carefully scrutinize the PAR to determine the disposition of the vehicle directly from the scene and, if towing is indicated, the reason for the towing.

If after the crash, a vehicle is pushed (by hand or by another vehicle) then consider the vehicle as a towed vehicle.

When a police report indicates that more than one event has occurred (*i.e.*, stabilization is apparent), the disposition of this vehicle is based upon the event sequence selected for stratification. In other words, if the PAR indicates this vehicle was towed from the scene, and a researcher determines from the PAR that towing was *not* due to the damage sustained during *this* sequence, the correct response for this variable is **Not towed due to vehicle damage**.

When the PAR indicates that this vehicle was towed from the scene and it *cannot* be determined whether or not the towing was due to damage, the default response for this variable is **Towed due to vehicle damage**.

Police Reported Tow Status (cont'd)

Page 2 of 2

**Not towed due to vehicle damage**

is selected when:

- the PAR indicates this vehicle was not towed from the scene,
- or**
- the PAR indicates this vehicle was towed from the scene but *not* due to crash-related disabling damage.

**Towed due to vehicle damage**

is selected when:

- the PAR indicates this vehicle was towed from the scene due to crash-related disabling damage,
- or**
- the PAR indicates this vehicle was towed from the scene and a researcher cannot determine (from the PAR data) if the towing was due to crash-related disabling damage.

**Unknown**

is selected when the investigating officer reported that the disposition of the vehicle was unknown at the time the PAR was completed. Also, use this attribute if the PAR indicates the vehicle was abandoned. However, if the police report specifies that the vehicle was disabled due to crash-related damage, as well as indicating "unknown", "abandoned" or blank for the disposition, it can be **assumed** that the vehicle will eventually be towed from the scene. In these instances, enter **Towed due to vehicle damage**

**POLICE REPORTED TRAVEL SPEED**

**Screen Name:** Police Reported-Travel Speed

**SAS Data Set:** *GV*

**SAS Variable:** *TRAVELSP*

**Oracle Name:** *VEHICLEPRECRASH.SPECIFYTRAVELSPEED*

**Element Attributes:**

Oracle	SAS	
		Enter police reported travel speed
-8879	777	Not Reported
-9999	999	Unknown

**Range:** 0-240, 999

**Source:** Police report only

**Remarks:**

Enter the travel speed for this vehicle if indicated on the police report by the investigating officer. **Do not** use estimates by drivers or witnesses.

Enter the nearest mph/kmph, or if the travel speed is reported as a range, enter the average.

**000 kmph**

is entered if this vehicle is stopped or indicated by the police as traveling less than 0.5 mph.

**Not Reported**

is used if no coded data block exists on the crash report and no other information is available. If a coded data block exists and left blank use this attribute.

**Unknown**

is selected if the estimated travel speed is unknown.

**POSTED SPEED LIMIT**

**Screen Name:** Posted Speed Limit

**SAS Data Set:** *GV*

**SAS Variable:** *SPLIMIT*

**Oracle Name:** *VEHICLEPRECRASH.SPECIFYSPEEDLIMIT*

**Element Attributes:**

Oracle	SAS	
		Enter posted speed limit in kmph
-8841	000	No statutory limit
-9999	999	Unknown

**Range:** 0-122, 999

**Source:** Primary sources are scene inspection or statutory law. ***Do not*** use the police report for selecting this variable's value.

**Remarks:**

A speed limit must be identified for all known crash scene locations.

If no speed limit sign is posted within a reasonable distance from the location of the first crash event along the approach leg of the roadway this vehicle was traveling on, then reference state statutes to obtain the applicable statutory maximum speed limit for the location (local or state).

Disregard advisory or other speed signs which do not indicate the legal speed limit. ***Do not confuse*** advisory signs on entrance/exit ramps or near intersections with the actual legal maximum speed limit.

If a state has a statute that uniformly reduces the maximum allowable speed within or near a construction zone, then code the indicated reduced limit.

**No statutory limit**

is selected for roadways which are neither posted nor have a statutory limit (*e.g.*, parking lot roadways or entrance/exits, service station entrance/exits, or driveways, etc.).

**Unknown**

is selected only in rare situations where a crash scene cannot be located.

**IS THE DRIVER PRESENT?**

**Screen Name:** Driver Present?

**SAS Data Set:** *GV*

**SAS Variable:** *DRPRES*

**Oracle Name:** *VEHICLE.DRIVERPRESENT*

**Element Attributes:**

Oracle	SAS	
1	0	No driver present
2	1	Yes
9	9	Unknown

**Source:** Researcher determined - inputs include the police report and interviews.

**Remarks:**

This variable serves as a flag to identify driverless motor vehicles in-transport.

**No Driver Present**

is selected if no driver was physically in the vehicle at the time that it was involved in the crash.

Selecting this attribute will preclude you from entering alcohol presence, other drug presence and precrash information for this vehicle.

**Yes**

includes those instances when the motor vehicle was a “hit-and-run” vehicle.

**Unknown**

is selected when it is not known if the driver was in the vehicle at the time of the crash.

**OCCUPANT NUMBER**

**Screen Name:** Occupant Number

**SAS Data Set:** N/A

**SAS Variable:** N/A

**Oracle Name:** ***OCCUPANT.OCCUPANTNUMBER***

**Element Attributes:**  
Occupant Number

**Source:** Researcher determined

**Remarks:**

Select the occupant number of the person who is the driver.

Note: Occupants are entered on the Case Form/Structure Tab/Occupants sub-tab.



**[NUMBER OF OCCUPANTS]**

**Screen Name:** N/A

**SAS Data Set:** *GV*

**SAS Variable:** *OCCUPANTS*

**Oracle Name:** *Derived from STRUCTURE/OCCUPANTS*

**Element Attributes:**

Oracle	SAS	This information rolls up from the number of occupants structured into the case for this vehicle.
	88	Non CDS vehicle

**Source:** This information rolls up from the number of occupants

**Remarks:**

This information rolls up from the number of occupants and is NOT entered in the field.

**[NUMBER OF OCCUPANT FORMS]**

**Screen Name:** N/A

**SAS Data Set:** *GV*

**SAS Variable:** *OCCFORMS*

**Oracle Name:** *Derived from STRUCTURE/OCCUPANTS*

**Element Values:** This information rolls up from the number of occupants structured into the case for this vehicle.

88 Non CDS vehicle

**Range:** 1-30 Blank (GV07 = 50-99)  
00 No driver present  
88 Not a CDS vehicle

**Source:** Researcher determined – inputs include police report, vehicle inspection and interviews

**Remarks:**

If this vehicle is a police reported *towed* CDS applicable vehicle [*i.e.*, GV07, Body Type, equals “01”-“49” *and* GV10, Police Reported Vehicle Disposition, equals “1” (Towed due to vehicle damage)], then an Occupant Assessment Form must be completed for each occupant. Enter the number of forms encoded and submitted for this vehicle. If this vehicle is not a CDS applicable vehicle (*i.e.*, GV07 equals “50”-“99”), then this variable must be left “**blank**”.

**Code “00”** (Zero Occupant Assessment Forms submitted) when:

- This vehicle is a police reported *nontowed* CDS vehicle [*i.e.*, GV07 equals “01”-“49” *and* GV10 equals “0” (Not towed due to vehicle damage) or “9” (Unknown)], or

This vehicle was in-transport and unoccupied

**Code “01”** (One occupant) includes the case of a “hit-and-run” police reported towed CDS applicable vehicle, where it is assumed that only one occupant/driver was present. Additional Occupant Assessment Forms (and thus increase the number coded here) can be submitted if reliable evidence exists that additional occupants were present.

**POLICE REPORTED ALCOHOL PRESENCE**

**Screen Name:** PAR Alcohol Presence  
**SAS Data Set:** *GV*  
**SAS Variable:** *DRINKING*  
**Oracle Name:** *DRIVER.ALCOHOLPRESENCE*

**Element Attributes:**

Oracle	SAS	
1	0	No alcohol present
2	1	Yes - alcohol present
3	7	Not reported
5	8	[No driver present]
4	9	Unknown

**Source:** Police report

**Remarks:**

The phrase "alcohol present" means that the police report indicates that the driver had consumed an alcoholic beverage. Presence is not an indication that alcohol was in any way a cause of the crash, even though it may have been. Finding opened or unopened alcoholic beverages in the vehicle does not by itself constitute presence.

**No alcohol present**

is selected if the investigating officer's assessment (as reported on the police report) is that no alcohol was present in the driver.

**Yes alcohol present**

is selected if the police indicate alcohol presence in the driver via: (1) a specific data element on the police report form, (2) the police charge the driver with DWI/DUI, (3) the police mention in the narrative section of the report that the driver had been drinking (or alcohol was present or involved), or (4) the police report has a positive blood alcohol concentration (BAC) test result (BAC > .00).

**Not reported**

is used if no coded data block exists on the crash report and no other information is available. If a coded data block exists and left blank use this attribute.

**Unknown**

is selected if alcohol presence is indicated as unknown. In general, police reports have blocks to check either positive or negative alcohol presence. However, if a police report has a provision for the investigating officer to respond "unknown presence", then use unknown. In addition, use unknown for hit-and-run drivers unless clear evidence to the contrary exists.

Some PARs have a block labeled "**Alcohol/Drugs**". If "presence" is indicated, and it cannot be determined which was used (*e.g.*, narrative, arrest/charged section, etc.), then assume alcohol presence. If the police report indicates that a driver was charged with DWI (driving while intoxicated or driving while impaired) and no clarification is offered to indicate if the DWI was alcohol related or other drug related (*i.e.*, a specific data element; mentioned in the narrative section; BAC results), then assume alcohol presence.

**ALCOHOL TEST FOR DRIVER**

**Screen Name:** Alcohol Test  
**SAS Data Set:** N/A  
**SAS Variable:** N/A  
**Oracle Name:** *DRIVER.ALCOHOLTEST*

**Element Attributes:**

Oracle	SAS	
1	0	Test Performed
2	95	Test Refused
3	96	None Given
4	97	BAC test performed, results unknown
6	98	[No driver present]
5	99	Unknown if test given

**Source:** Police report, medical reports, or other official sources.

**Remarks:**

No psychomotor (police observation of driver actions) test results are coded here. Also, be aware of preliminary test results. These preliminary tests, including an instrumented field screening test, indicate the presence of alcohol, but not necessarily the particular content level. Preliminary tests are designed to segregate candidates for further testing from those persons where the suspected presence of alcohol is either nonexistent or too low for additional tests.

**Test Performed**

when a test for Blood Alcohol Concentration (BAC) is administered either by the police or at a treatment facility.

**Test Refused**

when the person refuses to voluntarily take a BAC test, and no subsequent test is given.

**None Given**

when no BAC test is administered.

**BAC test performed, results unknown**

when the BAC test has been administered, but the results are unknown. Selecting this attribute will automatically blank out the Test Result variable.

Alcohol test for driver (cont'd)

Page 2 of 2

**Unknown**

is selected when it is not known if a test was administered.

**ALCOHOL TEST RESULT****Screen Name:** Test Result**SAS Data Set:** *GV***SAS Variable:** *ALCTEST***Oracle Name:** *DRIVER.ALCOHOLTESTRESULT***Element Attributes:**

Oracle	SAS	
		Enter BAC
2	95	[Test Refused]
3	96	[None Given]
4	97	[BAC test performed, results unknown]
6	98	[No driver present]
5	99	[Unknown if test given]

**Range:** 0-49 (0-.49), 95-99**Source:** Police report, medical reports, or other official sources.**Remarks:**

Blood Alcohol Concentration (BAC) measures, analytically, the mass of alcohol per unit volume of blood. The standard measure is expressed as the number of **milligrams per deciliter** (tenth of a liter) expressed as a decimal. (*e.g.*, .05 = 50 mg/100 ml; .15 = 150 mg/100 ml). A blood alcohol concentration (BAC) test could be a blood, breath, or urine test.

If the BAC was given on the police report or subsequently added after the case was initiated, enter the reported value. In essence, if any BAC is obtained, enter the reported value. For example, a BAC of 117 mg/dl is coded as 0.117.

**Not Applicable**

If the previous variable Driver- Alcohol Test is coded as "BAC Test performed, results "unknown" then this field is pre-filled.

**SOURCE OF ALCOHOL TEST RESULT**

Screen Name: Source

*SAS Data Set:* **GV***SAS Variable:* **ALCSRC***Oracle Name:* **DRIVER.ALCOHOLSOURCEID****Element Attributes:**

Oracle	SAS	
0	0	[No alcohol test result]
1	1	Police reported
2	2	Company reported
3	3	Medical record
4	4	Autopsy
5	5	Lay coroner
6	6	[No driver present]
8	7	Other (specify)
-8887	8	Not applicable

**Source:** Police report, medical reports, or other official sources.**Remarks:**

Enter source of data used to code the Blood Alcohol Concentration (BAC). Examples include PAR and Medical Reports. Medical Reports include Autopsy Report, ER report, discharge summary, nurse's notes, etc.

**Police reported**

is used when the BAC information is obtained from any record associated with the police.

**Medical Record**

is used when the BAC information was obtained from any medical report (i.e., ER report, discharge summary, nurses notes, etc.).

**Other (Specify)**

is used when the BAC information is obtained from some source other than those listed above. An example is a verbal BAC from an **official** source.



**OTHER DRUGS OVERVIEW**

These variables focus upon "other drugs". For the purpose of these variables the word "drug" is defined in nonmedical terms. A "drug" is any chemical substance, natural or synthetic which, when taken into the human body, can impair the ability of the person to operate a motor vehicle safely. The word "other" in this phrase means all "drugs" except alcohol, nicotine, aspirin, and drugs administered post-crash.

No laboratory, no matter how modern its equipment or competent its staff, can identify all drugs that are currently abused. Add to this the fact that new drugs, both licit and illicit, become available every week, and it soon becomes evident that the capacity for drug abuse always stays ahead of the capacity for chemical drug detection. Even if the laboratory does have the capability of identifying a particular drug, it will require that the drug be present at a specific minimum **concentration** before it can conclude that a "real" chemical detection has occurred. This is referred to as the **detection threshold**, and it varies from drug to drug, and from one chemical analytic method to another. Some of the analytic methods used by some laboratories to detect certain drugs do not actually seek to find the drug itself, but look instead for a **metabolite** of the drug. A metabolite is a chemical breakdown product of the drug.

**POLICE REPORTED OTHER DRUG PRESENCE**

**Screen Name:** PAR Other Drug Presence  
**SAS Data Set:** *GV*  
**SAS Variable:** *DRUGS*  
**Oracle Name:** *DRIVER.DRUGPRESENCE*

**Element Attributes:**

Oracle	SAS	
1	0	No other drug(s) present
2	1	Yes other drug(s) present
3	7	Not reported
5	8	[No driver present]
4	9	Unknown

**Source:** Police report.

**Remarks:**

The phrase "other drug present" includes all prescription, "over-the-counter" medications, as well as "illicit" substances (*e.g.*, in most cases, marijuana, cocaine, heroin). Also, "other drug present" means that the driver had ingested an other drug prior to the crash, but it is not an indication that the drug usage was in any way the cause of the crash (or event), even though it may have been. Finding other drugs in the vehicle does not by itself constitute presence.

**No other drug(s) present**

is selected if the investigating officer's assessment (as reported on the police report) is that no other drugs were present in the driver.

**Yes other drug(s) present**

is selected if the police indicate an other drug presence in the driver via: (1) a specific data element on the PAR, or (2) the police mention in the narrative section of the report that the driver had ingested an other drug.

**Not reported**

is used if no coded data block exists on the crash report and no other information is available. If a coded data block exists and left blank use this attribute.

Police Reported Other Drug Presence (cont'd)

Page 2 of 2

**Unknown**

is selected if other drug presence is indicated as unknown on the PAR. A growing number of police reports have blocks to check either positive or negative other drug presence. However, if a police report has a provision for the investigating officer to respond "unknown presence", then use this attribute. In addition, use this attribute for hit-and-run drivers unless clear evidence to the contrary exists.

NOTE: The police report must have a specific block on the PAR to report "Other Drug" presence, or it must be specifically mentioned in the narrative section. Some PARs have a block labeled "**Alcohol/Drugs**". If "presence" is indicated, and it cannot be determined which was used (*e.g.*, narrative, arrest/charged section, etc.), then assume alcohol presence. If the police report indicates that a driver was charged with DWI (driving while intoxicated or driving while impaired) and no clarification is offered to indicate if the DWI was alcohol related or other drug related (*i.e.*, a specific data element; mentioned in the narrative section; BAC results), then assume alcohol presence.

**OTHER DRUG TEST RESULT**

**Screen Name:** Other Drug Test Result  
**SAS Data Set:** *GV*  
**SAS Variable:** *SPECOTH*  
**Oracle Name:** *DRIVER.DRUGTESTRESULT*

**Element Attributes:**

Oracle	SAS	
1	0	No specimen test given
2	1	Drug(s) not found in specimen
3	2	Drug(s) found in specimen, specify
4	3	Specimen test given, results unknown or not obtained
6	8	[No driver present]
5	9	Unknown if specimen test given

**Source:** Police report, medical reports, or other official sources.

**Remarks:**

If a medical, police report, or other official source says that a certain drug was "screened for" or that it was "not detected", then you know that a specimen test was used. In addition, the presence of a measured quantity of an "other drug(s)" means that a specimen test was given. The specimen used in the test that obtained the measurement could be blood, urine, or an other specimen (*e.g.*, nasal swab, saliva). Some drugs are tested using a particular type of specimen; others can be tested in multiple ways. Researchers need to review toxicology (or other official) records carefully to determine which specimen or specimens were used for the driver's evaluation. Specimens are hierarchically ordered with a blood test taking preference over a urine test and urine over other.

**Drug(s) not found in specimen**

is selected if it is known that the driver had at least one type of specimen tested for other drugs *and* the test results came back "negative".

**Drug(s) found in specimen, specify**

is selected if it is known that the driver had at least one type of specimen tested for other drugs (excluding alcohol, nicotine, aspirin and drugs administered post-crash) and that the driver had a positive test result. A positive test result is any measured quantity that exceeds the detection threshold of the laboratory which performed the test.

Other drug test result (cont'd)

Page 2 of 2

**Specimen test given, results unknown or not obtained**

is selected if it is known that the driver had at least one type of specimen tested for other drugs, but the results of that test are unknown or not reported.

**Unknown if specimen test given**

is selected when it cannot be determined if the driver was administered a specimen test for other drugs. This attribute should also be selected if it is known that the driver received treatment at a medical facility but the medical records have not been obtained.

## DRIVER'S ZIP CODE

Page 1 of 2

Screen Name: ZIP Code

SAS Data Set: GV

SAS Variable: DRZIP

Oracle Name: DRIVER.ZIPCODE

## Element Attributes:

Oracle	SAS	
		Enter driver's ZIP code
1	00001	Driver not a resident of U.S. or territories
	99998	[No driver present]
-9999	99999	Unknown

**Range:** Range is a compilation of Sections 6 and 12 of the National Five Digit ZIP Code & Post Office Directory, Volume 2 N-W

**Source:** Primary source is the police report; secondary sources include interviewees, medical records, and other official documents.

**Remarks:****Prioritization of data sources:**

**First, use the PAR.** For the purposes of this variable, a driver is considered to reside at the address listed on the police crash report. This address was most likely taken from the driver's license given to the police officer and/or from the licensing state's drivers license file.

If the driver's address is present and the ZIP code is missing or not available, then determine the correct ZIP code by using the two volume National Five Digit Zip Code & Post Office Directory.

**Second, use official records (e.g., medical).** If the driver's ZIP code cannot be obtained from the PAR, then use official records, if available, to determine the correct ZIP code.

**Third, use interviewee data.** When no address (i.e., street number/name, city, state) is present on the PAR, ask the interviewee the driver's ZIP code as a "specific question" during the interview (page one of the Interview Form). If the interviewee does not know the driver's ZIP but does know the driver's address, then use this information to determine the ZIP code. When obtaining address information, determine what the driver considers his/her current permanent mailing address to be.

Driver's ZIP Code (cont'd)

Page 2 of 2

During the process of obtaining the interview, the vehicle inspection, or the associated medical records, researchers will discover, for some drivers, a conflict between the address listed on the PAR and the driver's current address. In conflict situations, always enter the ZIP code for the address given on the PAR or on an official document before entering the ZIP code from the information obtained during the interview.

**Driver not a resident of U.S. or territories**

is selected when the address found on the PAR or obtained from medical records, or during the interview indicates that the driver resides at an address which has not been assigned a ZIP code by the U.S. Post Office.

**Unknown**

is selected whenever the ZIP cannot be determined. For example, use **Unknown** for "hit-and-run" drivers and for any driver's address that you discover is fictitious. In addition, use **Unknown** if the driver, licensed or not, has no permanent address. For example, the driver could be living out of his/her vehicle (camper, motorhome, etc.), or the driver could be "homeless".

**RACE**

Page 1 of 3

**Screen Name:** Driver Race**SAS Data Set:** *GV***SAS Variable:** *D\_RACE***Oracle Name:** *OCCUPANT.RACE***Element Attributes:**

Oracle	SAS	
1	1	White
2	2	Black or African American
3	3	Asian
4	4	Native Hawaiian or Other Pacific Islander
5	5	American Indian or Alaska Native
7	7	Other (specify):
8	8	[No driver present]
-9999	9	Unknown

**Source:** Researcher determined; primary source is the interviewee; secondary sources include police report, medical records, and other official documents.

**Remarks:**

**Note:** Although this variable is on the **Official Records Tab**, this variable is a “self identification” by the occupant. This information can be obtained from any of the above sources, however is not always an “official record”. When using secondary sources, the ethnicity must be specifically mentioned in the document.

The concept of race as used by the U.S. Census Bureau reflects self-identification; it does not denote any clear-cut scientific definition of biological stock. Self-identification represents self-classification by people according to the race with which they identify themselves. For drivers with parents of different races who cannot provide a single response, use the race of the driver's mother; however, if a single response cannot be provided for the driver's mother, the first race reported by the driver is encoded.

Hispanic is not a race but rather an ethnic origin. Persons of Spanish origin may be of any race. For the purpose of this variable, race and Hispanic origin have been combined using the elements listed above.



Race (cont'd)

Page 2 of 3

**Prioritization of data sources:**

**First, use interviewee data.** Ask the interviewee what the driver considers their race and ethnic origin to be. If the response does not clearly fit into one of the race and ethnic origin categories, then use the information provided by the interviewee concerning the driver's nationality/ethnic origin to select the correct element value.

**Second, use the PAR.** If race is given on the PAR and the PAR scheme is compatible with this variable, then use the PAR information.

In addition, the driver's *name* is not a reliable indicator of race and **cannot be used** when selecting the applicable element value for this variable.

**Third, use official records (e.g., medical).** If the data needed cannot be obtained from the interviewee and is not available or usable from the PAR, then use official records, if available, to determine the correct element attribute.

**White**

is selected for drivers who consider themselves a person having origins in any of the original peoples of Europe, the Middle East or North Africa.

**Black or African American**

is for drivers who consider themselves a person having origins in any of the black racial groups of Africa. Terms such as "Haitian" or "Negro" can be used in addition to "Black or African American."

**Asian**

is selected for drivers who consider themselves a person having origins in any of the original peoples of the Far East, Southeast Asia, or the Indian subcontinent including, for example, Cambodia, China, India, Japan, Korea, Malaysia, Pakistan, the Philippine Islands, Thailand and Vietnam.

**Native Hawaiian or Other Pacific Islander**

is selected for drivers who consider themselves a person having origins in any of the original peoples of Hawaii, Guam, Samoa, or other Pacific Islands.

**American Indian or Alaska Native**

is selected for drivers who consider themselves a person having origins in any of the original peoples of North and South America (including Central America), and who maintains tribal affiliation or community attachment.

Race (cont'd)

Page 3 of 3

**Other**

is selected for drivers who consider themselves to be of a race not described above. Use this attribute for descriptions such as: Eurasian, Cosmopolitan, inter-racial, etc

**Unknown**

is selected when the source(s) available do not provide sufficient information to classify the driver's race.

**ETHNICITY**

Page 1 of 2

**Screen Name:** Driver Ethnicity**SAS Data Set:** *GV***SAS Variable:** *D\_ETHNIC***Oracle Name:** *OCCUPANT.ETHNICITY***Element Attributes:**

Oracle	SAS	
1	1	Hispanic or Latino
2	2	Not Hispanic or Latino
8	8	[No driver present]
-9999	9	Unknown

**Source:** Researcher determined; primary source is the interviewee; secondary sources include police report, medical records, and other official documents.

**Remarks:**

**Note:** Although this variable is on the **Official Records Tab**, this variable is a “self identification” by the occupant. This information can be obtained from any of the above sources, however it is not always an “official record”. When using secondary sources, the ethnicity must be specifically mentioned in the document.

The concept of ethnicity as used by the U.S. Census Bureau reflects self-identification; it does not denote any clear-cut scientific definition of biological stock. Self-identification represents self-classification by people according to the ethnicity with which they identify themselves. For drivers with parents of different ethnicity who cannot provide a single response, use the ethnicity of the driver's mother; however, if a single response cannot be provided for the driver's mother, the first ethnicity reported by the driver is encoded.

**Prioritization of data sources:**

**First, use interviewee data.** Ask the interviewee what the driver considers their ethnicity to be. If the response does not clearly fit into one of the ethnicity categories, then use the information provided by the interviewee concerning the driver's nationality/ethnic origin to select the correct element value.

Ethnicity (cont'd)

Page 2 of 2

**Second, use the PAR.** If ethnicity is given on the PAR and the PAR scheme is compatible with this variable, then use the PAR information.

If the PAR only indicates White/Caucasian, Black/Negro, or Other, then the PAR contains insufficient information for this variable. Additional information is required to determine the ethnicity. In addition, the driver's *name* is not a reliable indicator of ethnicity and **cannot be used** when selecting the applicable element value for this variable. For example, a name such as: Hector Smith, does not indicate the ethnicity (*e.g.*, Hispanic or Not Hispanic) since the person may or may not consider themselves to be of Hispanic descent.

**Third, use official records (*e.g.*, *medical*).** If the data needed cannot be obtained from the interviewee and is not available or usable from the PAR, then use official records, if available, to determine the correct element attribute.

**Element Attributes:****Hispanic or Latino**

is selected for drivers who consider themselves a person of Cuban, Mexican, Puerto Rico, South or Central American or other Spanish culture or origin, regardless of race. The term, "Spanish origin," can be used in addition to "Hispanic or Latino."

**Not Hispanic or Latino**

is selected for drivers who consider themselves as not being of Cuban, Mexican, Puerto Rico, South or Central American or other Spanish culture or origin, regardless of race.

**Unknown**

is selected when the source(s) available do not provide sufficient information to classify the driver's ethnic origin.

ENVIRONMENT

The screenshot shows a software window titled "General Vehicle Form, Case 2008-43-093B/ Vehicle #1". The window has a menu bar with "VEHICLE", "SPECIFICATIONS", "OFFICIAL RECORDS", "PRECRASH", "ROLLOVER", "RECONSTRUCTION", "DELTA V", "LOG", and "REVIEW". Below the menu bar are three tabs: "ENVIRONMENT", "MOVEMENT", and "DISTRACTIONS". The "ENVIRONMENT" tab is active and contains the following fields:

- Trafficway:** "Relation to ..." with a dropdown menu set to "Intersection related / non-interchange"; "Flow" with a dropdown menu set to "Divided trafficway-median strip without positive barri".
- Roadway:** "Travel Lanes" with a dropdown menu set to "Two"; "Alignment" with a dropdown menu set to "Straight"; "Surface Type" with a dropdown menu set to "Other (Specify)"; "Profile" with a dropdown menu set to "Level"; "Surface Condition" with a dropdown menu set to "Other (Specify)".
- Conditions:** "Light" with a dropdown menu set to "Daylight"; "Weather" with a dropdown menu set to "Other (specify):".
- Traffic Control Devices:** "Device" with a dropdown menu set to "Other regulatory sign (specify)"; "Functioning" with a dropdown menu set to "Traffic control device not functioning (specify)".

At the bottom right of the window are two buttons: "Save" (with a green checkmark icon) and "Close" (with a red X icon).

PRECRASH DATA OVERVIEW

The PreCrash variables are selected separately for each vehicle involved in the crash. They should be coded for the characteristics of their roadway environment just prior to the critical precrash event.

**RELATION TO INTERCHANGE OR JUNCTION**

**Screen Name:** Trafficway-Relation to Junction

**SAS Data Set:** *GV*

**SAS Variable:** *RELINTER*

**Oracle Name:** *VEHICLEPRECRASH.NONINTERCHANGEJUNCTION*

**Element Attributes:**

Oracle	SAS	
1	0	Non-interchange area and non-junction
2	1	Interchange area related
3	2	Intersection related/non-interchange
4	3	Driveway, alley access related/non-interchange
5	4	Other junction (specify) / non-interchange
6	5	Unknown type of junction / non interchange
7	9	Unknown

**Source:** Researcher determined — Primary source is the scene inspection, secondary sources include the police report and interviews.

**Remarks:**

The attribute selected is based on the characteristics of the roadway environment just prior to the critical precrash event for this vehicle

ANSI D16.1 should be referred to for additional information about the characteristics of junctions and interchanges.

A junction is, in general, the area formed by the connection of two roadways. It includes: (1) all at-grade intersections, (2) connections between a driveway access or alley access and a roadway which is not a driveway access or an alley access, (3) connections between two alley accesses or driveway accesses, or (4) a connection between a driveway access and an alley access.

Figure GV- 1: Flowchart for Determining Interchange or Junction

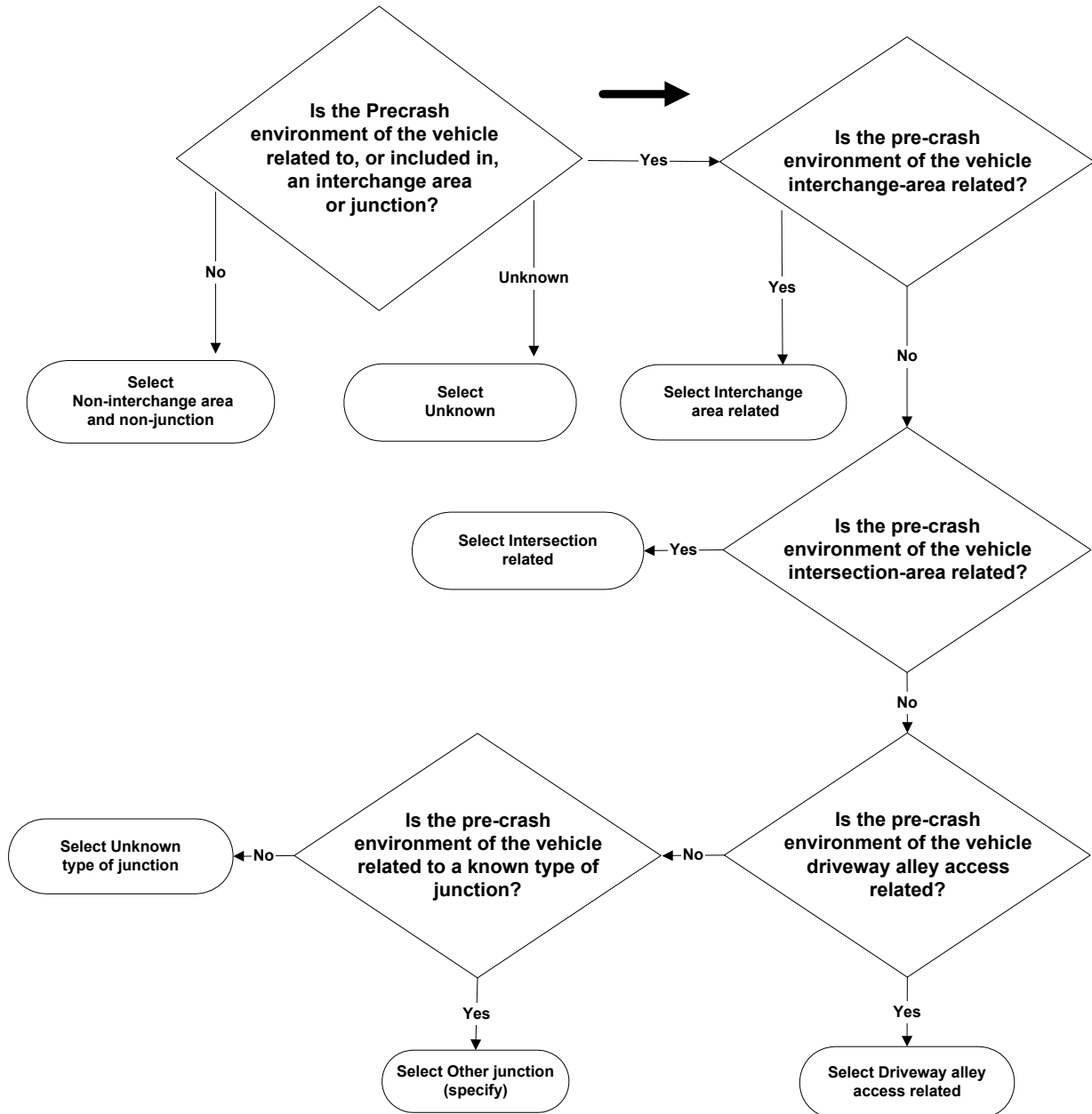

Relation to Interchange or Junction (cont'd)

Page 3 of 6

**Non-interchange area and non-junction**

is selected when the vehicle's environment just prior to the critical precrash event does not occur within an interchange area or within a junction.

**Interchange area related**

is selected when the vehicle's environment just prior to the critical precrash event occurs within an interchange area. An interchange is the area around a grade separation which involves at least two trafficways. Included within its boundaries are: (1) all ramps which connect the roadways, and (2) each roadway entering or leaving the interchange to a point 30 meters (100 feet) beyond the gore or curb return at the outermost ramp connection for the roadway. One may find included within an interchange area intersections, driveway accesses, and, of course, roadway sections which are non-junction. See Figure.



Figure GV- 2: Interchange Area

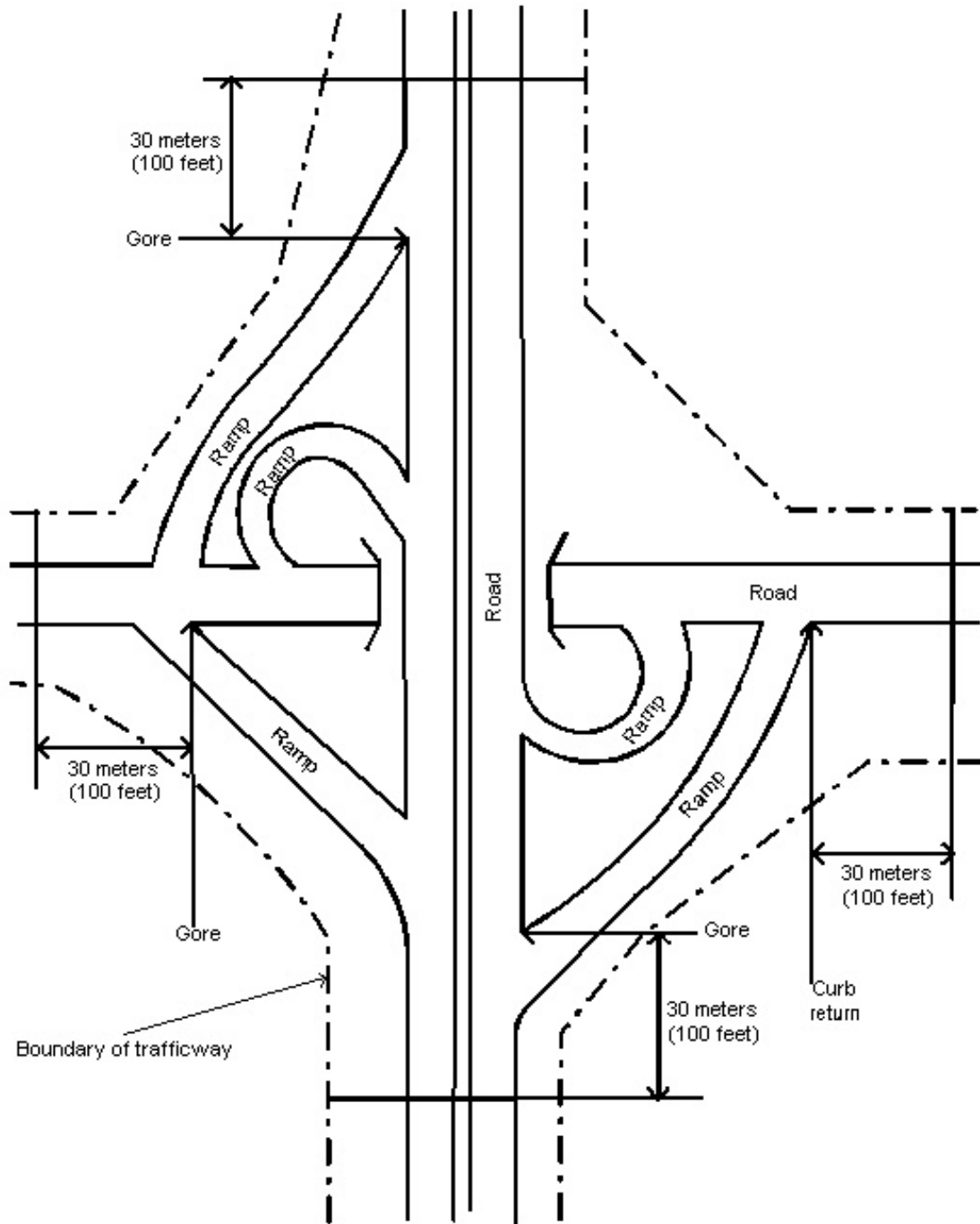

**Intersection Related**

is selected when the vehicle's environment just prior to the critical precrash event: (1) is in an intersection or is in an approach to or exit from an intersection; **and** (2) results from an activity, behavior, or control related to the movement of traffic units through the intersection.

"Traffic units" above means any traffic unit (involved or not involved in the crash). If the vehicle's environment just prior to the critical precrash event occurs outside but near an intersection and involves a vehicle which was engaged or should have been engaged in making an intersection-related maneuver such as turning, then **Intersection Related** must be selected. However, if the loss of control is unrelated to the intersection, then select **Non-interchange area and non-junction**.

An intersection is a type of junction which contains a crossing or connection of two or more roadways not classified as a driveway access or alley access.

**Intersection related** also includes any two leg intersections. To qualify for inclusion at least one of the two legs must be controlled by a regulatory sign (see **Traffic Control Device**) or traffic signal; otherwise, treat the area as a sharp curve.

A rotary or traffic circle is a specialized form of at-grade intersection. Traffic flows by entering and leaving a one-way roadway connecting all intersection approach legs and running continuously around a central island. Rotary intersections are commonly called *traffic circles*, but proper design can result in central islands of various rounded shapes.

**Driveway, alley access related**

is selected when the vehicle's environment just prior to the critical precrash event: (1) is an approach to or exit from the driveway or alley access; **and** (2) results from an activity, behavior, or control related to the movement of traffic units through the driveway or alley access. Use this attribute when the vehicle's environment just prior to the critical precrash event occurs on a NASS roadway which approaches or exits from the driveway or alley access junction and at least one involved pedestrian, other nonmotorist associated with a nonmotorist conveyance or road vehicle was entering or exiting from the driveway or alley. Do not use this attribute if the crash was precipitated by the action of a noncontact road vehicle or person.

**Other junction (specify) / non-interchange**

is selected when the vehicle's environment just prior to the critical precrash event is not interchange related, is not intersection related, is not driveway, alley access related, but does occur in a junction. The type of junction must be specified when this attribute is selected.

The following are examples of *non-interchange junctions*:

- A **channel** refers to any traffic lane that is directed into a path different than the through lanes by a traffic island. An **island** is defined as a raised or painted paved surface. The channel begins and ends at the extension of the island's lateral boundaries unless the channel is preceded or followed by an area of merge or divergence (see below). Select **Other junction**, specify- **channel** if the vehicle's roadway environment just prior to the critical precrash event was in the channel or on the traffic island (if the vehicle enters or strikes the island from within the channel).
- A **crossover** is a designated opening within a median used primarily for "U" turns". To be considered, the nearest lateral boundary line of the crossover must be greater than 10 meters (33 feet) from the nearest lateral boundary line of any roadway (highway, street, ramp, driveway, or alley) which intersects with either side of the roadways which the median divides. Select **Other junction**, specify-**crossover** if the characteristics of the vehicle's roadway environment just prior to the critical precrash event were in the junction of a crossover and a roadway. Do not use this attribute if the crash was precipitated by the actions of a noncontact road vehicle or person.
- **An area of merge or divergence** is in, and adjacent to an auxiliary lane, which is adjacent to the through lane(s) and follows an entrance ramp or channel or precedes an exit ramp or channel. A merge area extends longitudinally from where the ramp or channel ends and ends where the auxiliary lane ends. A divergence area extends longitudinally from where the auxiliary lane begins and ends where the ramp or channel begins. The area extends laterally across the through lane(s), for traffic in the same direction, ending at a centerline, median, or road edge/curb.

**Unknown type of junction / non interchange**

is selected when it is known that the vehicle's environment just prior to the critical event is in a junction, but the type of junction is unknown.

**Unknown**

is selected when the environment of the vehicle just prior to the critical event is unknown.

## TRAFFICWAY FLOW

Page 1 of 2

Screen Name: Trafficway-Flow

SAS Data Set: *GV*SAS Variable: *TRAFFLOW*Oracle Name: *VEHICLEPRECRASH.PICKTRAFFICFLOW***Element Attributes:**

Oracle	SAS	
2	1	Divided trafficway-median strip without positive barrier
3	2	Divided trafficway-median strip with positive barrier
4	3	One way traffic
1	4	Not physically divided (two way traffic)
6	5	Not physically divided with two way left turn lane
5	9	Unknown

**Source:** Researcher determined-Primary source is the scene inspection; secondary sources include the police report and interviews.

**Remarks:**

A roadway is that part of a trafficway where vehicles travel. A divided trafficway is composed of two or more roadways. A trafficway which has a median that is designed as a two-way left turn lane is considered to be one roadway for lane identification purposes.

If the characteristics of the vehicle's roadway environment just prior to the critical precrash event is represented by the junction of two or more roadways, choose the trafficway flow on the basis of the most representative description of the approach leg to the junction for this vehicle.

If the collision occurred other than in a junction, select the attribute on the basis of the most representative description of the characteristics of the vehicle's roadway environment just prior to the critical precrash event. If this is off the roadway, select the attribute on the basis of the most representative description of the roadway leading to the point of departure.

The Researcher selects the descriptor that best represents the vehicle's environment just prior to the critical precrash event. If the flow is designed to separate traffic, then choose accordingly.

**Not physically divided (two way traffic)**

is selected whenever there is no median. Generally, medians are not designed to legally carry traffic. **NOTE:** Although gores separate roadways, and traffic islands (associated with channels) separate travel lanes, neither is involved in the determination of trafficway division.

**Not physically divided with two-way left turn lane**

is used whenever the trafficway is physically divided by a two-way left turn lane which is designed to allow left turns to driveways, shopping centers, businesses, etc., while at the same time providing a separation of opposing straight-through travel lanes.

**Divided trafficway-median strip without positive barrier**

is selected whenever the trafficway is physically divided, however, the division is unprotected [*e.g.*, vegetation, gravel, paved medians, trees, water, embankments and ravines that separate a trafficway (*i.e.*, all non-manufactured barriers). NOTE: Raised curbed medians **DO NOT** constitute a positive barrier in and by themselves. The unprotected medians can be of any width, however, painted paved flush areas, must be 1.2 meters in width to constitute a median strip.

**Divided trafficway — median strip with positive barrier**

is selected whenever the traffic is physically divided and the division is protected by any concrete, metal, or other type of longitudinal barrier (*i.e.*, all manufactured barriers). Also bridges or underpass support structures and bridge rails take this attribute.

**One way trafficway**

is selected primarily whenever the trafficway is undivided and traffic flows in one direction (*e.g.*, one-way streets). However, this attribute can also be selected where a median is present so long as all the traffic on the trafficway goes in the same direction. An example occurs where the opposing roadway of the same named trafficway had to be split by such a distance that the right-of-way divides to accommodate other property. If (rare) one of the trafficways is further divided into multiple roadways by a median, then in this instance **One way trafficway** should be selected. Included are entrance and exit ramps.

**Unknown**

is selected if the trafficway flow cannot be determined (*e.g.*, ongoing construction and movable traffic barriers moved or removed since the crash date).

**NUMBER OF TRAVEL LANES**

**Screen Name:** Roadway-Number of Travel Lanes

**SAS Data Set:** *GV*

**SAS Variable:** *LANES*

**Oracle Name:** *VEHICLEPRECRASH.NUMOFLANES*

**Element Attributes:**

Oracle	SAS	
1	1	One
2	2	Two
3	3	Three
4	4	Four
5	5	Five
6	6	Six
7	7	Seven or more
8	9	Unknown

**Source:** Researcher determined--Primary source is the scene inspection — secondary sources include the police report and interviews.

**Remarks:**

The attribute is determined from the same roadway which was used to determine the **Trafficway Flow**. If traffic flows in both directions and is undivided, select the number of lanes in both directions. If the trafficway is divided into two or more roadways, select only the number of lanes for the roadway on which the vehicle under consideration was traveling.

If turn bays, acceleration, deceleration, or center 2-way left turn lanes exist and are physically located within the cross section of the roadway, and these lanes are the most representative of the driver's environment just prior to the critical precrash event, then they are to be included in the number of lanes. Channelized lanes are separated from other through or turn related lanes. (NOTE: The separation normally will not involve a physical barrier.) Because a channelized lane is separated, it should not be included unless it is preceded by a turn bay or turn lane and this bay or lane is felt to be most representative of the driver's environment just prior to impact.

The number of lanes counted does not include any of which are rendered unusable by restriction of the right-of-way (e.g., closed due to construction). Show lanes on the scaled diagrams and annotate why a lane is closed.

Only those lanes ordinarily used for motor vehicle travel should be considered when completing this variable (*i.e.*, pedestrian/bicycle lanes are excluded).

In a number of instances, there will be uncertainty as to the number of lanes due to: (1) nonstandard roadway widths; (2) variability of width in the same roadway due to disrepair and other reasons; or (3) absence of lane, center, and edge lines, etc. The number selected in these cases should represent the number of operational lanes based on customary or observed usage.

On a road that has legal parking such that the legal parking area ends short of the junction of the roadway with another roadway or drive; and the space left between the end of the legal parking area and the beginning of the junction can be utilized for turning by a vehicle on the roadway, do not consider this additional area as another travel lane (regardless of customary or observed usage in this instance).

This area should be construed as additional width to the existing travel lane(s). The only time that another lane will be counted at a junction is when that space is expressly designated for turning, *e.g.*, by lane (line or turn arrow) marking, signs or signals.

The number of lanes for driveways, wide-mouth parking lots, etc. should be selected as follows:

- If it is possible to determine the number of lanes through either lane markings or observed or customary use, select the actual number of lanes present.
- If the number of lanes cannot be accurately established, select **Unknown**.

If the vehicle was on or in a driveway [see Relation to Junction, definitions for **Driveway**, **alley access related**, or in a crossover (primarily designed as an opening in a median used for "U" turns)] which is in essence a private way, select the number of lanes for that vehicle.

**ROADWAY ALIGNMENT**

**Screen Name:** Roadway-Alignment

**SAS Data Set:** *GV*

**SAS Variable:** *ALIGNMNT*

**Oracle Name:** *VEHICLEPRECRASH.PICKROADWAYALIGNMENT*

**Element Attributes:**

Oracle	SAS	
1	1	Straight
2	2	Curve Right
3	3	Curve Left
4	9	Unknown

**Source:** Researcher determined--Primary source is scene inspection; secondary sources include the police report and interviews.

**Remarks:**

This element is determined from the same roadway which was used to determine Trafficway Flow. Select the descriptor that best represents the vehicle's environment just prior to this vehicle's critical precrash event.

Any perceptually determined curvature of a roadway constitutes a curve.

**Straight**

Refers to a roadway which has no perceptually determined curvature.

**Curve right and Curve left**

Refer to a perceptually determined curvature of a roadway. The vehicle's direction of travel determines whether the curvature is right or left.



**ROADWAY PROFILE**

**Screen Name:** Roadway-Profile

**SAS Data Set:** *GV*

**SAS Variable:** *PROFILE*

**Oracle Name:** *VEHICLEPRECRASH.PICKROADWAYPROFILE*

**Element Attributes:**

Oracle	SAS	
1	1	Level
2	2	Uphill grade (> 2%)
3	3	Hillcrest
4	4	Downhill grade (> 2%)
5	5	Sag
6	9	Unknown

**Source:** Researcher determined--Primary source is scene inspection; secondary sources include police report and interviews.

**Remarks:**

The element attribute is determined from the same roadway which was used to determine **Trafficway Flow**. Measure the area most representative of the precrash environment. To determine the grade, the vertical measurement is divided by the horizontal value; the result is a percentage value of the grade.

**Level**

is selected when the roadway surface tangent gradient is less than or equal to 2%. [i.e. vertical divided by horizontal (vertical / horizontal)]

**Uphill grade (> 2%)**

is selected when the roadway profile is uphill or positive, relative to the direction of travel of this vehicle.

**Hillcrest**

refers to a surface in vertical transition between two points of tangency.



**Downhill grade (> 2%)**

is used when the roadway profile is downhill or negative, relative to the direction of travel for this vehicle.

**Sag**

refers to a surface in vertical transition between two points of tangency.

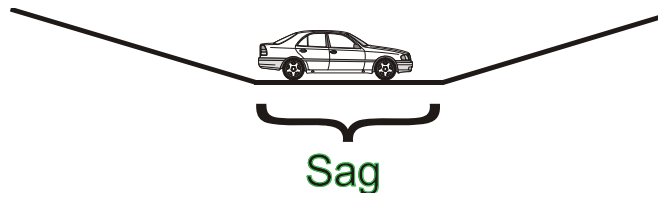

**Screen Name:** Roadway-Surface Type

**SAS Data Set:** *GV*

**SAS Variable:** *SURTYPE*

**Oracle Name:** *VEHICLEPRECRASH.PICKROAWAYSURFACE*

**Element Attributes:**

Oracle	SAS	
1	1	Concrete
2	2	Bituminous (asphalt)
3	3	Brick or block
4	4	Slag, gravel or stone
5	5	Dirt
6	8	Other, specify:
7	9	Unknown

**Source:** Researcher determined Primary source is scene inspection; secondary sources include police report and interviews.

**Remarks:**

This element attribute is determined from the same roadway which was used to determine the **Trafficway Flow**. If the lateral cross section contains lanes of more than one surface type, select the surface type of the lane the driver's vehicle was traveling on just prior to this vehicle's critical precrash event.

**Concrete**

is selected when the road surface is made of a material consisting of a conglomerate of gravel, pebbles, broken stone or slag, in a mortar or cement matrix.

**Bituminous (asphalt)**

is selected when the road surface is made of a product obtained by the distillation of coal and petroleum. Also referred to in non-technical terms as "blacktop."

**Brick or block**

is selected when the road surface is constructed of paving stone (*e.g.* cobblestone, paving bricks, etc.).

**Slag, gravel or stone**

is selected when the road surface is constructed of a loose material primarily consisting of the elements of slag, gravel or stone.

**Dirt**

is selected when the improved road surface is made of a natural earthen surface.

**Other specify**

is selected for another type of surface such as wood.

**Unknown**

is selected when the surface type is unknown.

**ROADWAY SURFACE CONDITION**

**Screen Name:** Surface Condition

**SAS Data Set:** *GV*

**SAS Variable:** *SURCOND*

**Oracle Name:** *VEHICLEPRECRASH.PICKROADWAYSURFACECOND*

**Element Attributes:**

Oracle	SAS	
1	1	Dry
2	2	Wet
10	3	Snow
11	4	Slush
12	5	Ice/Frost
13	6	Water (Standing, Moving)
14	7	Sand
15	8	Mud, Dirt, Gravel
16	9	Oil
17	88	Other, (specify):
18	99	Unknown

**Source:** Researcher determined Primary source is the police report; secondary sources include interviews, and scene inspection.

**Remarks:**

This element attribute is based on the location which best represents the Precrash Environment data. The element should be selected based on the same lanes used to select Trafficway Flow.

It is possible for different surface conditions to exist on the same roadway (*e.g.*, intermittent wet and dry sections). The researcher should consider the condition most representative of the roadway immediately prior to this vehicle's critical precrash event.

**Sand; Mud, Dirt, Gravel or Oil**

is selected when the attribute is present on another road surface. (*i.e.* a dirt road would not receive this attribute solely due to presence). If the sand; mud, dirt, gravel or oil occurs in combination with moisture conditions **Wet, Snow/Slush, Ice/Frost, or Water (Standing, Moving)** then select the moisture condition.

**LIGHTING CONDITIONS****Screen Name:** Conditions--Light**SAS Data Set:** *GV***SAS Variable:** *LGTCOND***Oracle Name:** *VEHICLEPRECRASH.PICKLIGHTCONDITIONS***Element Attributes:**

Oracle	SAS	
1	1	Daylight
2	2	Dark
3	3	Dark, but lighted
4	4	Dawn
5	5	Dusk
6	9	Unknown

**Source:** Researcher determined — Primary source is the police report; secondary sources include interviews and scene inspection.

**Remarks:**

The light condition best representing the precrash conditions at the time of the crash is selected based on ambient and artificial sources.

**Dark**

should be selected when the crash occurred after dusk and before dawn, and no artificial light source is present at the scene.

**Dark but lighted**

should be selected when the crash occurred after dusk and before dawn, and artificial light source(s) are present at the scene.

**NOTE:** **Dark** and **Dark, but lighted** include crashes occurring in tunnels.

**Unknown**

should be selected when it cannot be reasonably determined what the light conditions were at the time of the crash.

**WEATHER CONDITIONS**

**Screen Name:** Conditions--Atmospheric

**SAS Data Set:** *GV*

**SAS Variable:** *CLIMATE*

**Oracle Name:** *VEHICLEPRECRASH.PICKATMOSCONDITIONS*

**Element Attributes:**

Oracle	SAS	
11	11	Fog, Smog, Smoke
12	12	Rain
13	13	Sleet, Hail (freezing rain or drizzle)
14	14	Snow
15	15	Blowing Snow
16	16	Severe Crosswinds
17	17	Blowing Sand, Soil, Dirt
18	18	Clear
19	19	Cloudy
98	98	Other (specify):
99	99	Unknown

**Source:** Researcher determined — primary source is the police report; secondary sources include interviews and scene inspection.

**Remarks:**

The atmospheric condition is selected with respect to the conditions just prior to the critical event. Select the attribute that had the most affect on the visibility of the driver. The element attributes are oriented toward precipitation, or particle dispersion, which may affect the driver visibility.

It is possible for different drivers to experience different conditions.

**Fog, Smog, Smoke**

This attribute is selected when one of the below conditions affects driver visibility:

- 1) Fog is described as condensed water vapor in cloudlike masses lying close to the ground and limiting visibility.
- 2) Smog is described as a fog made heavier and darker by smoke and chemical fumes; *also:* a photochemical haze caused by the action of solar ultraviolet

Weather conditions (cont'd)

Page 2 of 3

radiation on atmosphere polluted with hydrocarbons and oxides of nitrogen from automobile exhaust.

- 3) Smoke is described as a vaporous system made up of small particles of carbonaceous matter in the air, resulting mainly from the burning of organic material, such as wood or coal.

**Rain**

is selected when the precipitation falling at the time of the crash is predominately in the form of water droplets.

**Sleet, Hail (Freezing rain or drizzle)**

is selected when the precipitation falling at the time of the crash is predominately in the form of frozen or partially frozen raindrops.

**Snow**

is selected when the precipitation falling at the time of the crash is predominately in the form of translucent ice crystals originating in the upper atmosphere as frozen particles of water vapor. This attribute includes rain mixed with snow. Accumulation is not necessary to select this attribute.

**Blowing Snow**

is selected when wind driven snow reduces visibility and causes significant drifting. Blowing snow may be snow that is falling and/or loose snow on the ground picked up by the wind.

**Severe Crosswinds**

is selected when the wind is blowing at right angles to the effected vehicle. Severe crosswinds are considered when the wind is blowing over 39 mph (63 kph).

**Blowing Sand, Soil, Dirt**

is selected when sand, soil or dirt particles are picked up from the surface of the earth by the wind, that affects driver visibility.

**Clear**

is selected when the sky has less than 50 % cloud cover.

**Cloudy**

is selected when the sky has more than 50 % cloud cover.

**Other (specify)**

is used when there is a relevant weather related factor that is not described in the preceding elements. Specify the nature of this factor in detail.



Weather conditions (cont'd)

Page 3 of 3

**Unknown**

is used when there is insufficient information to determine what weather conditions were present at the time of the crash.

## TRAFFIC CONTROL DEVICE

Page 1 of 5

Screen Name: Traffic Control--Device

SAS Data Set: *GV*SAS Variable: *TRAFCONT*Oracle Name: *VEHICLEPRECRASH.PICKTRAFFICCTRLDEVICE*

## Element Attributes:

Oracle	SAS	
1	0	No traffic control(s)
2	1	Traffic control signal (not RR crossing)

Oracle	SAS	
3	2	Stop sign
4	3	Yield sign
5	4	School zone sign
6	5	Other regulatory sign (specify):
7	6	Warning sign (not RR crossing)
8	7	Unknown sign
9	8	Miscellaneous/other controls including RR controls (specify):
10	9	Unknown

**Source:** Researcher determined — primary source is scene inspection; secondary sources include the police report and interviews.

**Remarks:**

This attribute is determined from the same roadway used to define the Trafficway Flow. The Researcher should select the descriptor that best controls traffic in the vehicle's environment just prior to this vehicle's critical precrash event.

This variable measures the above-ground traffic control(s) which regulate vehicular traffic. Excluded are any controls which *solely* regulate pedestrians (*e.g.*, wait/walk signals).

Focus on the road segment just prior to the location of the critical precrash event and select the traffic control device(s) which is (are) *most related* to this event. In-junction crashes should be based on the presence of a traffic control device for the roadway on which the vehicle is traveling. For non-junction crashes, traffic control devices should be selected based on their relationship to the crash circumstances and *not* be based merely on presence.

<b>Regulatory signs</b>	Give notice of traffic laws or regulations.
<b>Warning signs</b>	Call attention to conditions on, or adjacent to, a highway or street that are potentially hazardous to traffic operations.
<b>Guide signs</b>	Show route designations, destinations, directions, distances, services, points of interest, and other geographical recreational or cultural information. Guide signs do not constitute traffic controls.

Signs come in standard shapes. The *octagon* is exclusively used for the STOP sign. The *equilateral triangle*, with one point downward, is used exclusively for the YIELD sign. The *round* shape is used for the advance warning of a railroad crossing and for the civil defense evacuation route marker. The *pennant* shape, an isosceles triangle, with its longest axis horizontal, is used to warn of no passing zones. The *diamond* shape is used only to warn of existing or possible hazards either on or adjacent to the roadway or adjacent thereto. The *(vertical) rectangle*, ordinarily with the longer dimension vertical, is used for regulatory signs, with the exception of STOP signs and Traffic Control Device YIELD signs. The *(horizontal) rectangle*, ordinarily with the longer dimension horizontal is used for route markers and recreational area guide signs.

The *pentagon*, point up, is used for School Advance and School Crossing signs. *Other* shapes are reserved for special purposes; for example, the shield or other characteristic design for route markers and crossbuck for railroad crossings.

Signs can be distinguished by their color. The following general rules apply. **Red** is used as a background color on prohibitory type regulatory signs (*e.g.*, STOP, Do Not Enter, Wrong Way). It is also used as the circular outline and diagonal bar prohibitory symbol. **BLACK** may be used as a background (*e.g.*, ONE WAY); it is used as a message on white, yellow and orange signs. **WHITE** is used as the background for route markers, guide signs, and regulatory signs (except STOP). It is used as the legend for brown, green, blue, black and red signs. **Orange** is used only as a background color for construction and maintenance signs. **Yellow** is used as a background color for warning signs and for school signs. **Brown, green, and Blue** are used as a background color for guide signs.

Pavement markings are used to supplement the regulations or warnings of other devices such as traffic signs or signals. In other instances, they are used alone and produce results that cannot be obtained by the use of any other device. Pavement markings can convey warnings or information to the driver without diverting his attention from the roadway. **Pavement markings are not considered when completing this variable.**

The Researcher should consider the intent of this question. If at the time of the crash there was no intent to control (regulate or warn) vehicle traffic, then select **No traffic controls**; otherwise, select the appropriate value.

For example, if the intersection is channelized and controlled differently on the channel than on the through lanes (*e.g.*, signal and yield sign), report the traffic controls depending on whether the roadway (Number of Travel Lanes) was chosen based on its through lanes or its channelized lanes.

The attributes are in prioritized order. This means that **Traffic Control Signal** takes precedence over **school zone signs, other regulatory signs, and warning signs**.

If a school guard, police officer, or other officially designated person controls both pedestrian and vehicular traffic, select **miscellaneous/other controls, including RR controls**.

**NOTE:** The only exception to the prioritization rule is that any *Officially-designated* person (**miscellaneous controls**) takes precedence over any other attribute.

#### **No Traffic Control**

is selected when there is no above ground sign or signal to regulate traffic flow. If a traffic control device has been deactivated (*e.g.* traffic signal that emits no signal) during certain times of the day, and was deactivated at the time of the crash select **No** used for regulatory signs.

#### **Traffic Control Signal (Not RR crossing)**

Includes a traffic control that has been recently installed, but not activated as of the time of the crash.

Use **Traffic Control Signal (Not RR crossing)** for all of the following:

- Any signal which processes through the green, amber, and red cycles. The source of the actuation is of no concern.
- A green, amber and red cycling signal which a signal is missing or inoperable.
- A green, amber, and red cycle capability, but is being used to flash amber/red or red/red.
- A flashing beacon — capable of only flashing amber/red or red/red signals.
- Lane use control signals including turn arrows and controls which govern the direction of traffic flow in lanes (*e.g.*, electrically controlled overhead "X" or arrow used at different times of the day or on bridges to govern the direction of traffic flow in the lane.)

Any portable signal that controls traffic flow (*i.e.*, gas-powered directional signal to divert traffic for an impending lane closure).

A traffic control signal that is out (*e.g.* due to a power failure) and was related to the crash, should be indicated as present, unless a temporary control [*e.g.*, stop sign, police officer, miscellaneous controls etc.] has been inserted, in which case the temporary control should be selected.

**NOTE:** Regulatory signs which are *enhanced* by flashing lights should be selected based on their regulatory design. (*e.g.*, a stop sign with a flashing light should be coded as a stop sign - disregard the flashing light).

**Stop sign**

is selected when a trafficway is controlled by an octagon-shaped sign, with white letters and border on a red background.

**Yield sign**

is selected when a trafficway is controlled by an equilateral-shaped triangle, with one point downward, having a red border band and white interior and the word "YIELD" in red inside the border band.

**School zone sign**

is selected when a school zone warning sign is present. These signs may include a 5-sided sign with the point at the top, a rectangular, school speed zone sign, or some other black printing on a yellow background sign.

A school zone sign is selected only if the crash occurred during the time the sign was in effect (*i.e.*, school must be in-session). If the sign was in effect it does not matter whether or not children were present. The time of the crash should also be correlated to the day of the week and the effect of holidays, vacations, etc.

**Other regulatory sign (Specify):**

is selected when a regulatory sign other than a "stop" or "yield" sign is present. "Other" signs include speed limit signs, movement signs (*e.g.*, NO TURN, LEFT TURN ONLY, DO NOT ENTER, WRONG WAY, ONE WAY, ), parking signs (*e.g.*, NO PARKING, EMERGENCY PARKING ONLY), and other miscellaneous signs (*e.g.*, ROAD CLOSED TO THROUGH TRAFFIC, WEIGHT LIMIT, etc.)

**Warning sign (Not RR crossing)**

is selected when a sign is used to warn of an existing or potentially hazardous condition on or adjacent to a highway or street. Generally warning signs are diamond-shaped with black legend and a border on a yellow background. Examples include TURN SIGNS, CURVE SIGNS, WINDING ROAD SIGN, STOP AHEAD SIGN, "T" SYMBOL SIGNS, etc. Some warning signs are horizontal rectangles, for example, a large arrow sign intended to give notice of a sharp change in alignment in the direction of travel.

**Unknown sign**

is used when a regulatory sign *was present* at the time of collision but was removed or not available during the scene inspection to determine its type and the PAR is not specific about a traffic control presence.

**Miscellaneous/other controls including RR controls (Specify):**

is selected when the following are present:

- A construction warning sign (any black on orange diamond shaped sign).
- Railroad crossing controls are present (e.g., any gates, flashing lights, bells, crossbuck, or railroad crossing sign, circle with a black "X" on a yellow background).
- *Officially designated* person controls both pedestrian and vehicular traffic (e.g., police officer, crossing guard, flag person, etc.)

**NOTE:** An *officially designated* person controlling traffic takes precedence over any other attributes.

**TRAFFIC CONTROL DEVICE FUNCTIONING**

**Screen Name:** Traffic Control--Functioning

**SAS Data Set:** *GV*

**SAS Variable:** *TRCTLFCT*

**Oracle Name:** *VEHICLEPRECRASH.PICKTRAFFICDEVICE*

**Element Attributes:**

Oracle	SAS	
1	0	[No traffic control(s)]
2	1	Traffic control device not functioning (specify):
3	2	Traffic control device functioning properly
4	9	Unknown

**Source:** Researcher determined--inputs include scene inspection, interviews, and police report.

**Remarks:**

**Traffic control device not functioning (specify):**

is selected in the following situations:

- The traffic control device was not operating.
- The traffic control device reported has some function, but the function was improper, inadequate, or operating erratically (*e.g.*, signal works but was stuck on red).
- The traffic control device was defaced, badly worn, rotated so it could not be seen, covered with snow, lying on ground, etc.

**Traffic control device functioning properly**

is selected when the traffic control device was functioning as designed at the time of the crash.

**Unknown**

is selected when the status of the traffic control device, at the time of the crash, cannot be determined.

MOVEMENT

General Vehicle Form, Case 2008-43-093B / Vehicle #1

VEHICLE | SPECIFICATIONS | OFFICIAL RECORDS | PRECRASH | ROLLOVER | RECONSTRUCTION | DELTA V | LOG | REVIEW

ENVIRONMENT | MOVEMENT | DISTRACTIONS

Pre-event Movement (Prior to Recognition of Critical Event) Other (specify)

Critical Pre-Crash Category Other (specify)

Critical Pre-Crash Event Other (Specify)

Attempted Avoidance Maneuver Other action (specify)

Pre-Impact Stability Tracking

Pre-Impact Location Stayed in original travel lane

Crash Type 76

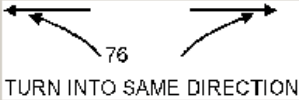

Turn Into Path Change Trafficway Vehicle Turning

Save Close



**PRECRASH DATA OVERVIEW**

Page 1 of 20

Precrash variables are completed for each of the in-transport vehicles in the case. This means that the entire crash is first completed from the perspective of one vehicle, then from the perspective of a second vehicle, if any, and so forth. The precrash variables are:

Driver's Distraction/Inattention To Driving (Prior To Recognition Of Critical Event)  
Pre-Event Movement (Prior to Recognition of Critical Event),  
Critical Precrash Category  
Critical Precrash Event,  
Attempted Avoidance Maneuver,  
Pre-Impact Stability  
Pre-Impact Location  
Crash Type

The precrash variables are designed to identify the following:

what was this vehicle doing just prior to the critical precrash event,  
what made this vehicle's situation critical,  
what was the avoidance response, if any, to this critical situation, and  
what was the movement of the vehicle just prior to impact?

The most important determination that must be made for each in-transport vehicle is: what was this vehicle's Critical Precrash Event, (*i.e.*, what action by this vehicle, another vehicle, person, animal, or nonfixed object was critical to this vehicle's crash?). Once the critical event is determined, the remaining precrash variables are coded relative to this selected **Critical Precrash Event**.

Do not consider culpability as a factor for determining precrash data. Many crash scenarios will suggest fault, but this is considered coincidental rather than by design.

**Critical Crash Envelope**

The critical crash envelope begins at the point where:

- (1) the driver recognizes an impending danger (*e.g.*, deer runs into the roadway), or
- (2) the vehicle is in an imminent path of collision with another vehicle, pedestrian, pedalcyclist, other nonmotorist, object, or animal.

The critical crash envelope ends when:

- (1)
  - (a) the driver has made a successful avoidance maneuver and
  - (b) has full steering control, and
  - (c) the vehicle is tracking; or
- (2) the driver's vehicle impacts another vehicle, pedestrian, pedalcyclist, other nonmotorist, object, or animal.

### **Simple Single Critical Crash Envelope**

Most crashes involve only a single critical crash envelope in which the object contacted is captured under the Critical Precrash Event, (*e.g.*, a vehicle is traveling straight on a roadway and a deer runs into the roadway and is struck by the vehicle). This scenario, and similar ones, are very straightforward and will not present many problems.

### **Complex Single Critical Crash Envelope**

However, some single critical crash envelopes are more complex.

**Example A:** A driver avoids one obstacle and *immediately* impacts another vehicle, person, object, or animal. Because *immediate* is defined as **not** having an opportunity, or sufficient time, to take any additional avoidance actions, the Critical Precrash Event is related to the vehicle, person, object, or animal which the driver successfully avoided instead of the vehicle's first harmful event (*i.e.*, its impact); see examples 4 and 7 below.

**Example B:** The driver avoids an obstacle only to (a) lose steering control and/or (b) have the vehicle stop tracking, and the vehicle subsequently impacts another vehicle, person, object, or animal. Regardless of whether the driver:

- 1) attempted to regain steering control
- 2) caused the vehicle to resume a tracking posture or
- 3) avoided the impacted vehicle, person, object, or animal

the Critical Precrash Event is similarly related to the vehicle, person, object, or animal which the driver successfully avoided because the driver's critical crash envelope was never stabilized.

In both examples above, the Attempted Avoidance Maneuver records the successful action taken to avoid the Critical Precrash Event.

Vehicles that are not involved in an impact with another vehicle, person, object, or animal in the sequence of crash events (that define this crash) are not included in the CDS; data is not collected for these vehicles. However, these vehicles are included in the Crash Collision Diagram.

The coding order for a single critical crash envelope is illustrated below.

### **Multiple Critical Crash Envelopes**

When a case involves multiple critical crash envelopes, select only the final critical crash envelope. In this situation, encode the variable Pre-Event Movement (Prior to Recognition of Critical Event) as: **Successful avoidance maneuver to a previous critical event**. The final critical crash envelope is the one that resulted in this vehicle's first harmful event (*i.e.*, its impact) as shown in the following illustration.

Typical Order of a Single Critical Crash Envelope

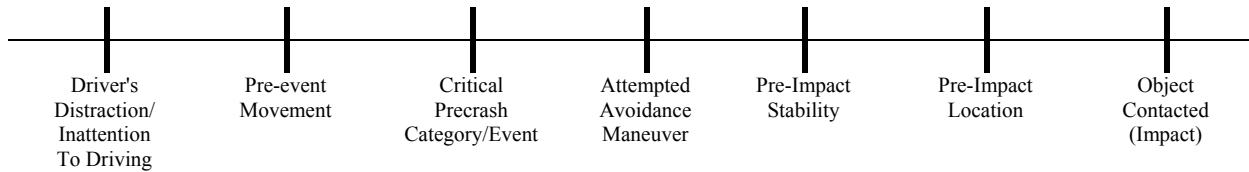

Typical Order of Multiple Critical Crash Envelopes

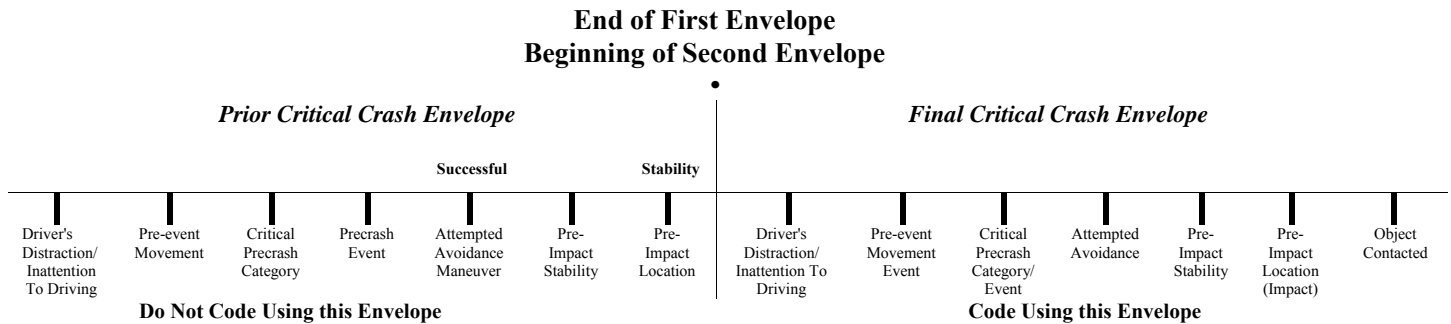

When there is doubt as to whether this vehicle had experienced a complex single, or multiple critical crash envelopes, choose the Critical Precrash Category/Event, to the vehicle, person, object, or animal which the driver successfully avoided (i.e., default to Complex Single). See Complex Single Critical Crash Envelope examples A and B above.

The following pages have: a method protocol, a flowchart illustrating the proper method and protocol for determining the precrash variables, and eight examples of various crash event sequences which contain one or more critical crash envelopes.

**Method Protocol**

Consider the information obtained from the Police Report, scene and vehicle inspections, and from the interviewee(s) as inputs to your decision making process.

**1. Determine Critical Precrash Category / Critical Precrash Event.**

What action by this vehicle, another vehicle, person, animal, or object was critical to this driver becoming involved in the crash (*i.e.*, use the "BUT FOR"\* test)?

ASK yourself questions (a) through (f) below. Proceed through each question that applies to the crash you are researching. Stop when the answer to the questions is "Yes". This is the Critical Precrash Category.

- (a) Did the vehicle exhibit a control loss?
- (b) Does the evidence suggest that the vehicle was in an environmentally dangerous position?
- (c) Was another vehicle "in" this vehicle's lane?
- (d) Was another vehicle entering into this vehicle's lane?
- (e) Was a pedestrian, pedalcyclist, or other nonmotorist in or approaching this vehicle's path?
- (f) Was an animal in or approaching this vehicle's path or was an object in this vehicle's path?

**2. Determine Driver's Distraction / Inattention to Driving.****3. Pre-Event Movement (Prior to Recognition of Critical Event.)****4. Determine Attempted Avoidance Maneuver.**

What does your information indicate that the driver tried to do to avoid the crash?

**5. Determine Pre Impact Stability****6. Determine Pre-Impact Location****\* FOR EXAMPLE :**

**"But for"** Vehicle # going left-of-center, this vehicle would not have been involved in this crash.

**"But for"** having entered into the intersection, this vehicle would not have been involved in this crash.

Precrash Methodology Flowchart

\* FOR EXAMPLE :

"But for" Vehicle # going left-of-center, this vehicle would not have been involved in this crash.

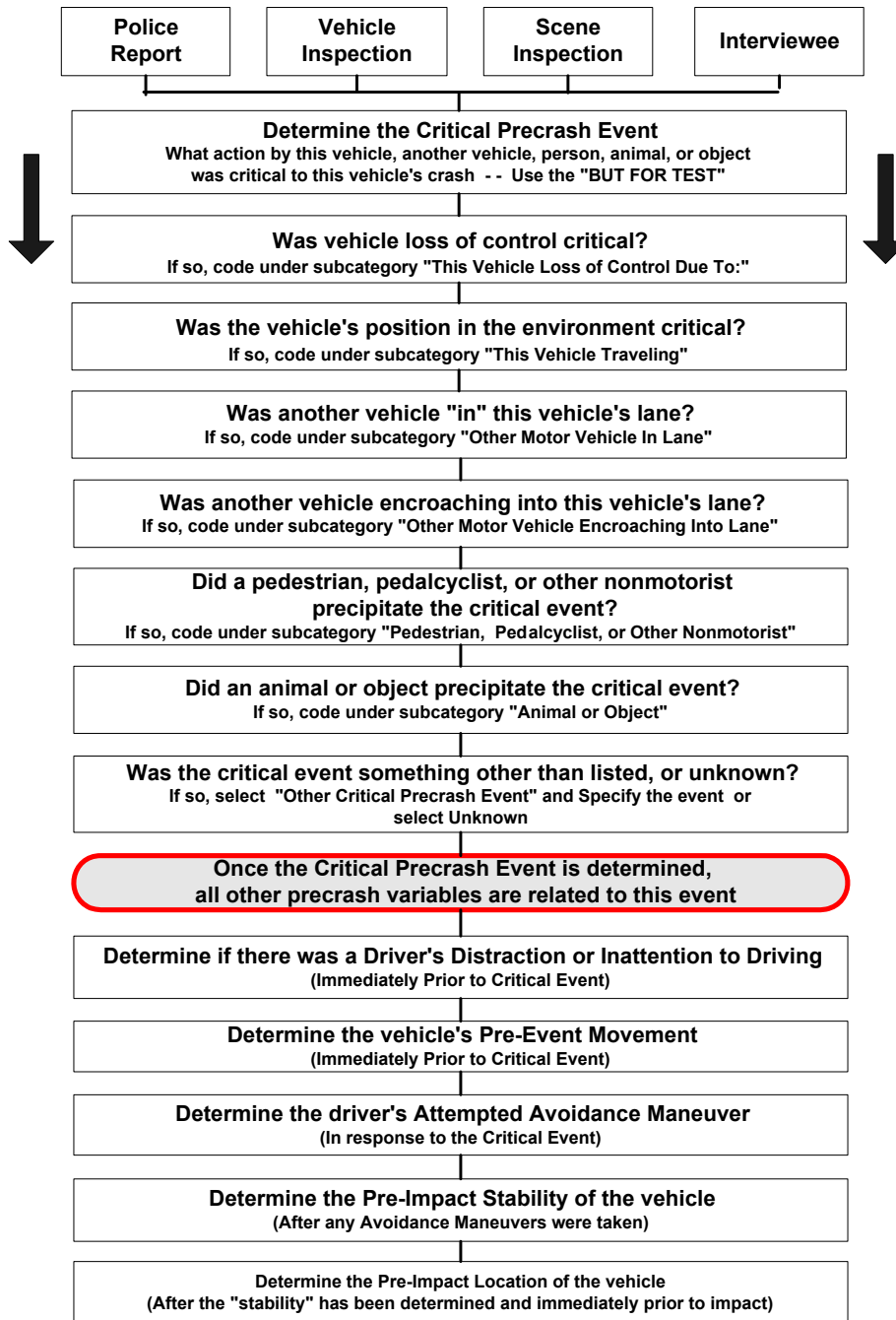

"But for" having entered into the intersection, this vehicle would not have been involved in this crash.

## Precrash General Rules

1. Attempted Avoidance Maneuver assesses what the driver's action(s) were during the critical crash envelope in response to his/her realization of impending danger.
2. The mere presence of a traffic control signal/sign typically does not make the situation critical when determining Critical Precrash Event.

For example: A single vehicle approaches a stop sign and departs the right side of the road impacting a tree, in an attempt to avoid passing through the intersection. The sign has no bearing and therefore, does not make the situation critical.

3. When you know what the Critical Precrash Category, but are unable to select a specific Critical Precrash Event, use the following guideline:

Default to one of the "Other" or unknown attributes within each Critical Precrash Event category, rather than coding the entire Critical Precrash Category as "Other critical precrash event".

4. If control is loss due to driver illness such as heart attacks, diabetic comas, etc., then Critical Precrash Event should be coded as "Other cause of control loss."
5. When coding Critical Precrash Category as "This vehicle loss of control", the loss of control must have occurred prior to the driver doing any avoidance maneuver. If the driver attempts a maneuver (*i.e.*, brakes, steers, etc.) as a result of the driver's perception of a vehicle, object, pedestrian, or nonmotorist, then select the vehicle, object, pedestrian, or nonmotorist as the critical event because that is what made the situation critical. If the vehicle is in a yaw prior to the driver taking an avoidance action, then loss-of-control is what made it critical (*e.g.*, critical curve scuff, hydroplaning, etc.).
6. When determining Critical Precrash Category/Event, if you do not know from available sources which driver had the right-of-way at a controlled or uncontrolled intersection, then use the following as a guideline:
  - a. If the junction is controlled by a 3-way / 4-way stop sign, or is uncontrolled, then use the common rule that ***the vehicle on the right has the right-of-way*** for determining encroachment.

- b. If the junction is controlled by an on-colors traffic control device, and both drivers claim a green light, then both vehicles are in an environmentally dangerous position, and Critical Precrash Event for both vehicles should be **This Vehicle Traveling** (Critical Precrash category) Crossing over (passing through) intersection (Critical Precrash Event).
7. When two vehicles are initially traveling on the same trafficway and one executes a left turn with the right-of-way (i.e. green arrow), use **Other Motor Vehicle Encroaching Into Lane - From opposite direction-over right lane line** for the turning vehicle's critical event. This applies to Crash Types 68-69.  
  
If the vehicles were initially on different trafficways (Crash Types 76-77 and 82-83) the critical event for the vehicle turning left with the right-of-way should be **Other Motor Vehicle Encroaching – From crossing street across path**.
8. "Fixed" objects (e.g., trees, poles, fire hydrants, etc.,) cannot be in the roadway.
9. A motor vehicle is stopped in a travel lane and is impacted by another motor vehicle ricocheting off a vehicle. The Critical Precrash Event for the vehicle struck by the ricocheting vehicle is in the category of either: **Other Motor Vehicle In Lane** or **Other Motor Vehicle Encroaching Into Lane**.
10. Pre-Impact stability should be indicated as "**Tracking**" if the following are met:
  - a. no skid marks are present at the scene
  - b. the PAR or the interviewee does not indicate skidding **AND**
  - c. the vehicle did not rotate 30 degrees or more (either clockwise or counterclockwise).

*Trafficway and its component definitions (i.e., roadway, road, shoulder and median) can be found in the ANSI D16.1 Manual on the Classification of Motor Vehicle Traffic Accidents.*



**Example 1**

Vehicle 2 is northbound and passing through an intersection on a roadway without a traffic control. The driver of vehicle 1 is dialing on a cellular phone. Vehicle 1 is eastbound on a crossing roadway with a stop sign but did not see it. Driver of Vehicle 2 was attentive but did not see Vehicle 1 approaching. Vehicle 1 crashes into the side of vehicle 2. Vehicle 1 braked (leaving skid marks) just prior to impact, without any steering.

	<i>Vehicle 1</i>	<i>Vehicle 2</i>
Driver's Distraction/Inattention to Driving	(Distracted) while dialing cellular phone	Looked but did not see
Pre-Event Movement	Going straight	Going straight
Critical Precrash Category	This Vehicle Traveling	Other motor vehicle encroaching into lane
Critical Precrash Event	Crossing over (passing through) intersection	From crossing street across path
Attempted Avoidance Maneuver	Braking (lockup)	No avoidance maneuver
Pre-Impact Stability	Skidding longitudinally - rotation less than 30 degrees	Tracking
Pre-Impact Location	Stayed in original travel lane	Stayed in original travel lane
Crash Type	88	89

Example 1 (cont'd)

In this example, vehicle 1 has one *critical crash envelope* ( $V_1CCE$ ) which begins at the point where driver 1 recognizes that vehicle 1 is in an imminent collision path with vehicle 2. Vehicle 1's critical crash envelope ends at the point of impact with vehicle 2.

Vehicle 2 has one *critical crash envelope* ( $V_2CCE$ ). Although the driver of vehicle 2 did not recognize the danger, vehicle 2's critical crash envelope begins at the point where vehicle 2 is in an imminent path of collision with vehicle 1. Vehicle 2's critical crash envelope ends at the point of impact with vehicle 1.

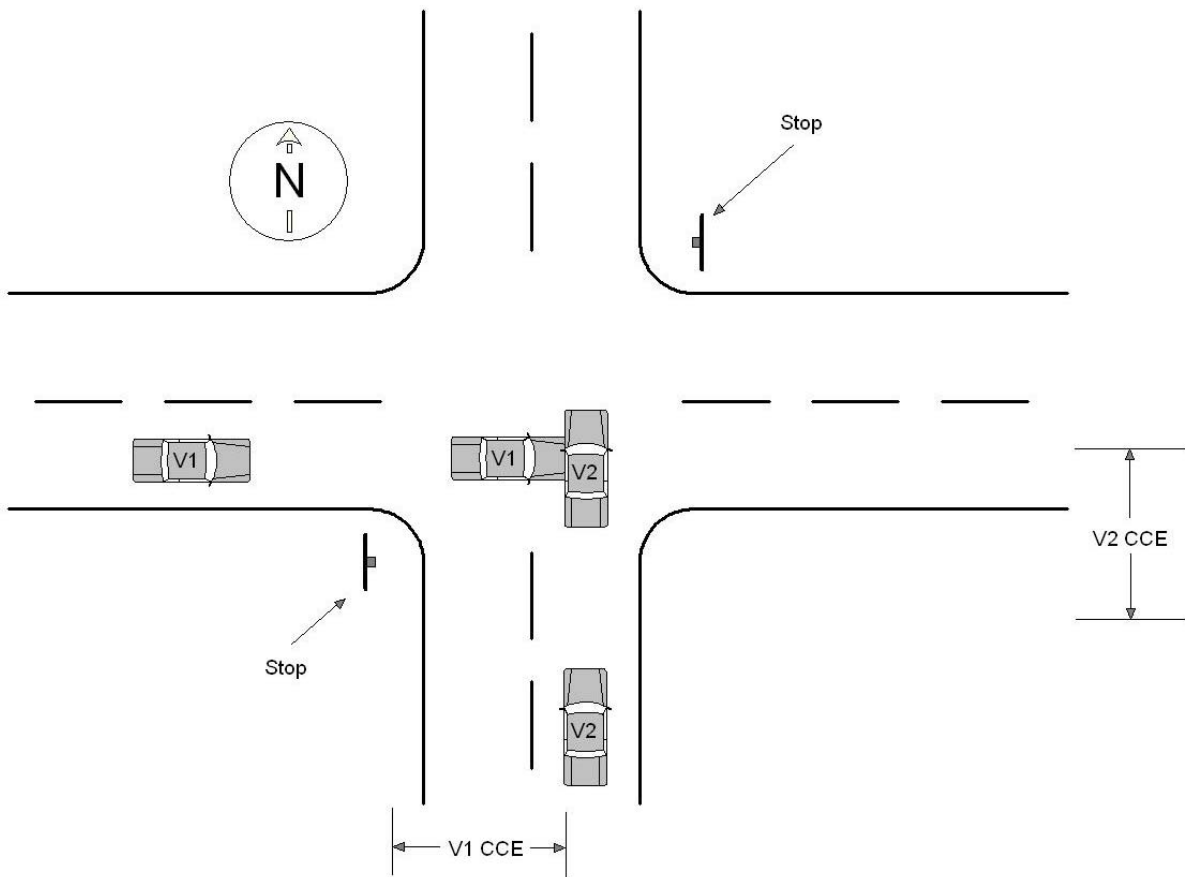

**Example 2**

Vehicle 1 and vehicle 2 are traveling in opposite directions on the same roadway. The driver of vehicle 1 falls asleep and crosses over the center line into the travel lane of vehicle 2. Vehicle 2 attempted to avoid vehicle 1 by steering right onto the shoulder and accelerating. Vehicle 1 impacted vehicle 2 in the side.

	<i>Vehicle 1</i>	<i>Vehicle 2</i>
Driver's Distraction/Inattention to Driving	Sleepy or fell asleep	Attentive or not distracted
Pre-Event Movement	Going straight	Going straight
Critical Precrash Category	This vehicle traveling	Other motor vehicle encroaching into lane
Critical Precrash Event	Over the lane line on left side of travel lane	From opposite direction over left lane line
Attempted Avoidance Maneuver	No avoidance maneuver	Accelerating and steering right
Pre-Impact Stability	Tracking	Tracking
Pre-Impact Location	Stayed on roadway, but left original travel lane	Departed roadway
Crash Type	64	65

Example 2 (cont'd)

In this example, vehicle 1 has one *critical crash envelope* ( $V_1$ CCE) which begins at the point where vehicle 1 crosses over the lane line and ends at the point of impact with vehicle 2.

Vehicle 2 has one *critical crash envelope* ( $V_2$ CCE) which begins at the point where driver 2 recognizes vehicle 1 encroaching into his/her travel lane. Vehicle 2's critical crash envelope ends at the point of impact with vehicle 1.

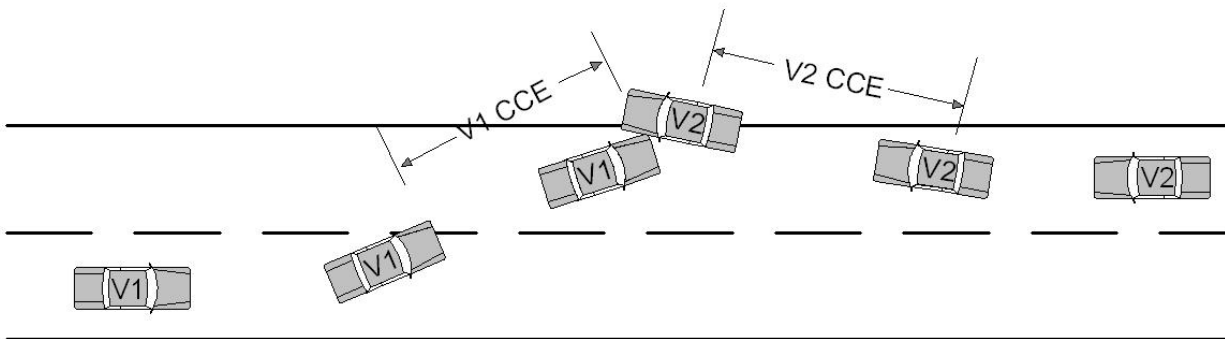

**Example 3**

Vehicle 1 is traveling eastbound. A noncontact vehicle (NCV) is westbound and attempts to turn left in front of Vehicle 1 into an intersecting private driveway. Vehicle 1 braked (without lockup) and steered left to avoid the noncontact vehicle. The driver of Vehicle 1 successfully avoided the noncontact vehicle and maintained full control, but crossed into the westbound lane. Now traveling the wrong way in the westbound lane, Vehicle 1 attempted to steer right and return to the eastbound lane but struck Vehicle 2 head on. Vehicle 2 attempted to avoid the crash by braking and steering right.

Vehicle 2 has one critical crash envelope (V2CCE<sub>1</sub>) which begins at the point where the driver of Vehicle 2 recognizes Vehicle 1 in his/her lane and ends at the point of impact with Vehicle 1.

The noncontact vehicle was not involved in an impact with another vehicle, person, animal, or object in the sequence of crash events and is therefore not included in the Crashworthiness Data System. However, the noncontact vehicle must be shown on the Crash Collision Diagram.

	<i>Vehicle 1</i>	<i>Vehicle 2</i>
Driver's Distraction/Inattention to Driving	Attentive or not distracted	Attentive or not distracted
Pre-Event Movement	Successful avoidance maneuver to a previous critical event	Going straight
Critical Precrash Category	Other motor vehicle in lane	Other motor vehicle in lane
Critical Precrash Event	Traveling in opposite direction	Traveling in opposite direction
Attempted Avoidance Maneuver	Steering right	Braking and steering right
Pre-Impact Stability	Tracking	Tracking
Pre-Impact Location	Stayed in original travel lane	Stayed in original travel lane
Crash Type	52	52

In this example, vehicle 1 has two critical crash envelopes ( $V_1CCE_1$  and  $V_1CCE_2$ ). Vehicle 1's first **critical crash envelope** ( $V_1CCE_1$ ) ends at the point where the driver of vehicle 1 made a successful avoidance maneuver and maintained full control of the vehicle. Vehicle 1's second **critical crash envelope** ( $V_1CCE_2$ ) begins immediately following the successful avoidance maneuver and ends at the point of impact with vehicle 2. Use the critical crash envelope which resulted in vehicle 1's first impact ( $V_1CCE_2$ ).

Vehicle 2 has one **critical crash envelope** ( $V_2CCE$ ) which begins at the point where driver 2 recognizes vehicle 1 in his/her travel lane and ends at the point of impact with vehicle 1.

The noncontact vehicle was not involved in an impact with another vehicle, person, animal, or object in the sequence of crash events and is therefore not included in the Crashworthiness Data System. However, the noncontact vehicle must be shown on the Crash Collision Diagram.

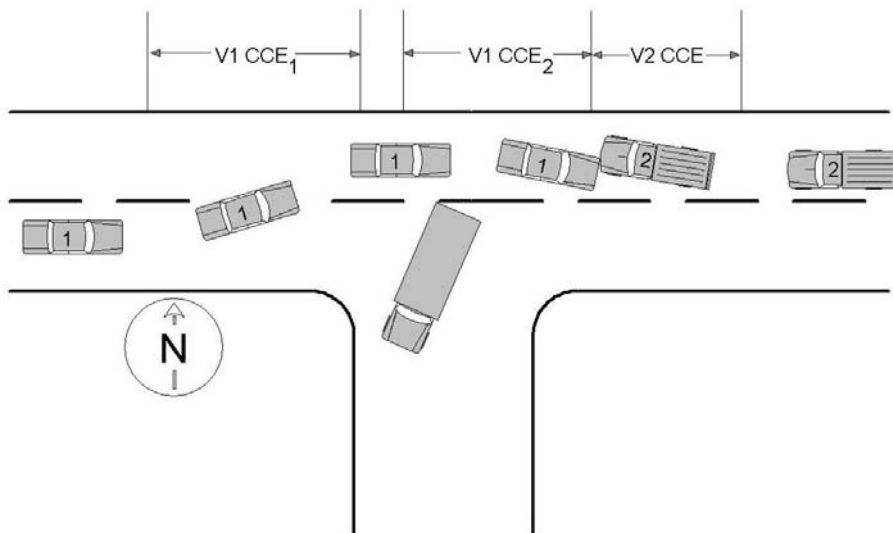

**Example 4**

Vehicle 1 and vehicle 2 are traveling in opposite directions on the same roadway. The driver of vehicle 1 brakes (without lockup) and steers left to avoid a pedestrian who darted into his/her travel lane. Vehicle 1 crosses over the center line into the travel path of vehicle 2. The driver of vehicle 2 was talking with a passenger and not paying close attention to driving and at the last second attempted to avoid vehicle 1 by braking and steering right onto the shoulder. Vehicle 2 skids and rotates clockwise about 45 degrees before it is impacted in the front by vehicle 1.

	<i>Vehicle 1</i>	<i>Vehicle 2</i>
Driver's Distraction/Inattention to Driving	Attentive or not distracted	(Distracted) by other object, occupant or event
Pre-Event Movement	Going straight	Going straight
Critical Precrash Category	Pedestrian, Pedacyclist, or other nonmotorist	Other Motor Vehicle encroaching into lane
Critical Precrash Event	Pedestrian in roadway	From opposite direction over left lane line
Attempted Avoidance Maneuver	Braking and steering left	Braking and steering right
Pre-Impact Stability	Tracking	Skidding laterally - clockwise rotation
Pre-Impact Location	Stayed on roadway but left original travel lane	Departed roadway
Crash Type	60	61

In this example, vehicle 1 has one critical crash envelope ( $V_1CCE$ ). Vehicle 1's critical crash envelope involved a successful avoidance of a pedestrian [*i.e.*, Critical Precrash Event equals **Pedestrian in roadway**] which resulted in an *immediate* impact to vehicle 2. Therefore, the pedestrian is coded as the critical precrash event for vehicle 1. Vehicle 1's avoidance maneuver is for this example, the action taken to avoid the pedestrian.

Vehicle 2 has one *critical crash envelope* ( $V_2CCE$ ) which begins at the point where driver 2 recognized and reacted to vehicle 1 in his/her travel lane and ends at the point of impact with vehicle 1.

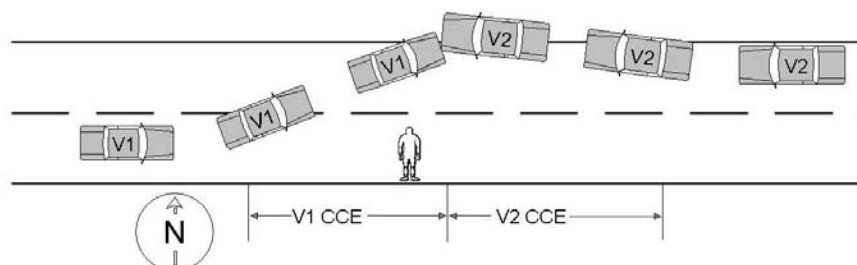

**Example 5**

Vehicle 1 and vehicle 2 are traveling in the same direction in adjacent lanes on a divided highway (with a painted median). While the driver of vehicle 1 was using an electric razor, the vehicle has a blow out, driver 1 loses control, crosses the left lane line and impacts the right rear of vehicle 2. Vehicle 2 is redirected across the painted median, skidding and rotating clockwise, and subsequently impacts vehicle 3. Vehicle 3 attempted to avoid vehicle 2 by steering right and accelerating.

	<i><b>Vehicle 1</b></i>	<i><b>Vehicle 2</b></i>
Driver's Distraction/Inattention to Driving	[Distracted] while using or reaching for device/object brought into in vehicle	Attentive or not distracted
Pre-Event Movement	Going straight	Going straight
Critical Precrash Category	This vehicle loss control due to	Other motor vehicle encroaching into lane
Critical Precrash Event	Blow out or flat tire	From adjacent lane (same direction) - over right lane line
Attempted Avoidance Maneuver	No avoidance maneuver	No avoidance maneuver
Pre-Impact Stability	Tracking	Tracking
Pre-Impact Location	Stayed on roadway, but left original travel lane	Stayed in original travel lane
Crash Type	45	44
	<i><b>Vehicle 3</b></i>	
Driver's Distraction/Inattention to Driving	Attentive or not distracted	
Pre-Event Movement	Going straight	
Critical Precrash Category	Other motor vehicle encroaching into lane	
Critical Precrash Event	From opposite direction - over left lane line	
Attempted Avoidance Maneuver	Accelerating and steering right	
Pre-Impact Stability	Tracking	
Pre-Impact Location	Stayed in original travel lane	
Crash Type	98	



Example 5 (cont'd)

In this example, vehicle 1 has one **critical crash envelope** ( $V_1CCE$ ) which begins with control loss due to the blow out and ends at the point of impact with vehicle 2. The blow out is the critical precrash event.

Vehicle 2 has two critical crash envelopes ( $V_2CCE_1$  and  $V_2CCE_2$ ). Vehicle 2's first **critical crash envelope** ( $V_2CCE_1$ ) begins when vehicle 1 enters vehicle 2's travel lane and ends at the point of impact with vehicle 1. Vehicle 2's second **critical crash envelope** ( $V_2CCE_2$ ) begins immediately after the first impact and ends at the point of impact with vehicle 3. Use the critical crash envelope which resulted in vehicle 2's first impact ( $V_2CCE_1$ ), because the NASS CDS is only interested in coding the critical crash envelope which leads to a vehicle's first harmful event.

For this example, Vehicle 3 has one critical crash envelope ( $V_3CCE$ ) which begins when driver 3 recognizes and reacts to vehicle 2 which is in an imminent path of collision with vehicle 3 and ends at the point of impact with vehicle 2.

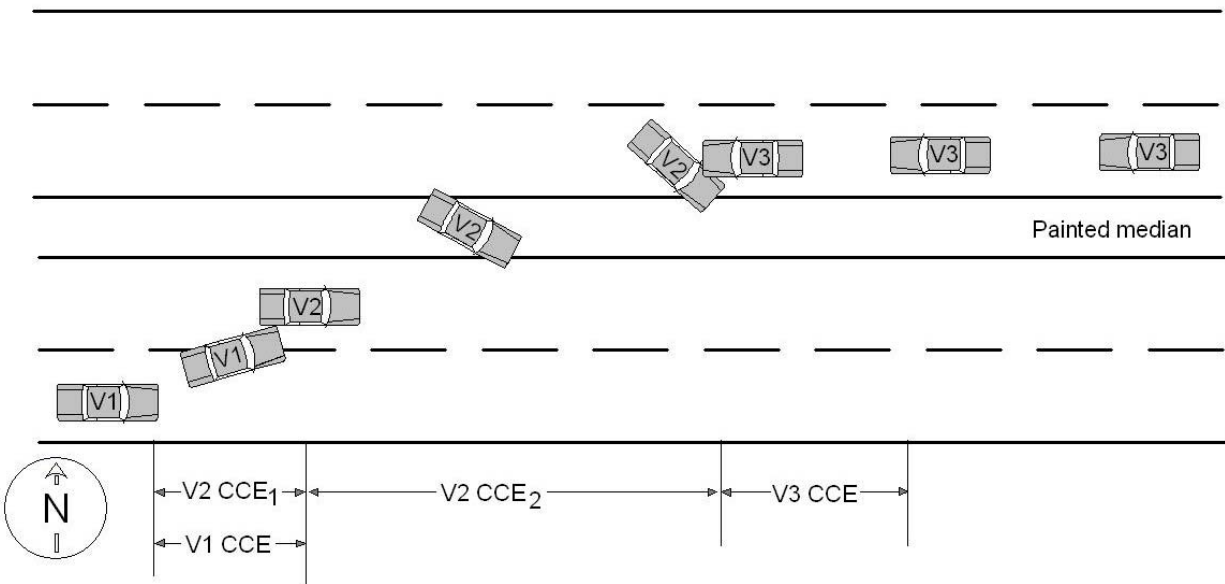

**Example 6**

Vehicle 1 and vehicle 2 are traveling in opposite directions on the same roadway. A noncontact vehicle is parked in front of a noncontact truck-tractor (with a trailer) on the road shoulder and suddenly enters the roadway into vehicle 1’s travel lane. The driver of vehicle 1 instantly brakes (with lockup) and steers left (with counterclockwise rotation) to avoid the noncontact vehicle. Vehicle 1 crosses over the center line and *immediately* impacts vehicle 2. Vehicle 2 had no avoidance maneuvers.

	<i>Vehicle 1</i>	<i>Vehicle 2</i>
Driver’s Distraction/Inattention to Driving	Attentive or not distracted	Attentive or not distracted
Pre-Event Movement	Going Straight	Going Straight
Critical Precrash Category	Other motor vehicle encroaching into lane	Other motor vehicle encroaching into lane
Critical Precrash Event	From parking lane/shoulder	From opposite direction over left lane line
Attempted Avoidance Maneuver	Braking and steering left	No avoidance actions
Pre-Impact Stability	Skidding laterally – counterclockwise rotation	Tracking
Pre-Impact Location	Stayed on roadway but left original travel lane	Stayed in original travel lane
Crash Type	58	59

In this example, vehicle 1 has one critical crash envelope (V<sub>1</sub>CCE). Vehicle 1's critical crash envelope involved a successful avoidance of a noncontact vehicle and resulted in an *immediate* impact to vehicle 2. Vehicle 1's critical crash envelope was initiated by the noncontact vehicle, afterwards there was no opportunity for subsequent avoidance actions. Therefore, the encroachment of the noncontact vehicle into vehicle 1's travel lane is coded as the critical precrash event for vehicle 1. Vehicle 1's avoidance maneuver is coded as the action taken to avoid the noncontact vehicle.

Example 6 (cont'd)

Vehicle 2 has one *critical crash envelope* ( $V_2$ CCE) which begins at the point where vehicle 1 is in an imminent path of collision with vehicle 2 and ends at the point of impact with vehicle 1.

The noncontact vehicle and the noncontact truck were not involved in an impact in the sequence of crash events and are therefore not coded in the Crashworthiness Data System. However, the noncontact vehicle and truck must be shown on the Crash Collision diagram.

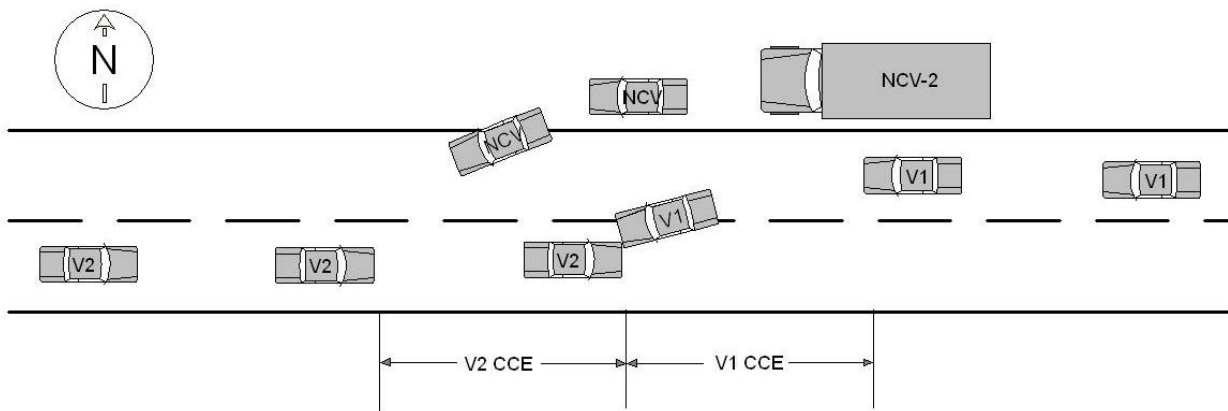

**Example 7**

Vehicle 1 and Vehicle 2 are traveling in opposite directions on the same roadway. A police car (with lights activated) is making a traffic stop on the side of the road. The driver of Vehicle 1 is looking at the activity on his left. Before he can react, Vehicle 1 crosses the centerline and strikes the front of Vehicle 2. The driver of Vehicle 2 also noticed the police activity, but he was attentive to the slowing traffic ahead. Vehicle 2 attempted to avoid the crash by braking and steering right.

	<i>Vehicle 1</i>	<i>Vehicle 2</i>
Driver's Distraction/Inattention to Driving	Distracted by outside person, object, or event	Attentive or not distracted
Pre-Event Movement	Going straight	Going straight
Critical Precrash Category	This vehicle traveling	Other motor vehicle encroaching into lane
Critical Precrash Event	Over the lane line on left side of travel lane	From opposite direction over left lane line
Attempted Avoidance Maneuver	No avoidance maneuver	Braking and steering right
Pre-Impact Stability	Tracking	Tracking
Pre-Impact Location	Stayed on roadway but left original travel lane	Stayed in original travel lane
Crash Type	50	51

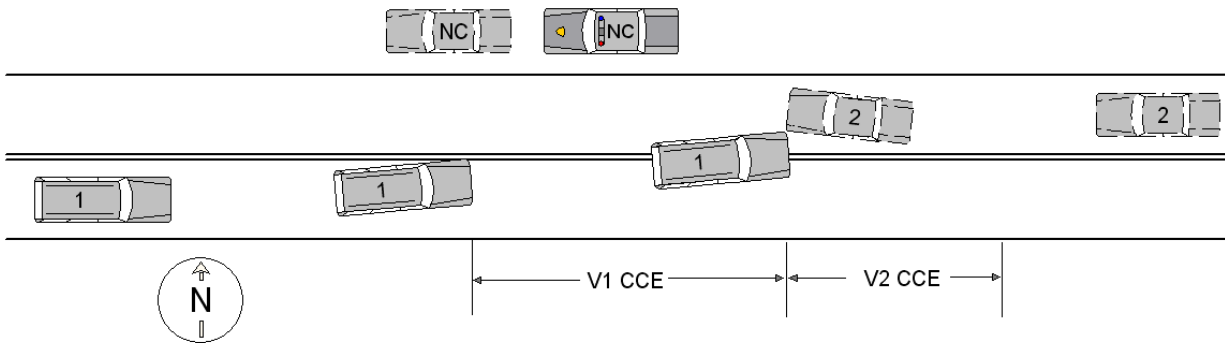

**PRE-EVENT MOVEMENT (PRIOR TO RECOGNITION OF CRITICAL EVENT)**

Page 1 of 3

**Screen Name:** Pre-Event Movement (Prior to Recognition of Critical Event)**SAS Data Set:** *GV***SAS Variable:** *REMOVE***Oracle Name:** *VEHICLEPRECRASH.PICKPREEVENTMOVEMENT***Element Attributes:**

Oracle	SAS	
0	0	[No Driver Present]
1	1	Going straight
2	2	Decelerating in road
3	3	Accelerating in road
4	4	Starting in road
5	5	Stopped in road
6	6	Passing or overtaking another vehicle
7	7	Disabled or parked in travel lane
8	8	Leaving a parking position
9	9	Entering a parking position
10	10	Turning right
11	11	Turning left
12	12	Making a U-turn
13	13	Backing up (other than for parking position)
14	14	Negotiating a curve
15	15	Changing lanes
16	16	Merging
17	17	Successful avoidance maneuver to a previous critical event
18	98	Other (specify):
19	99	Unknown

**Source:** Researcher determined — inputs include scene, interviews and police report.**Remarks:**

Record the attribute which best describes this vehicle's activity prior to the driver's realization of an impending critical event or just prior to impact if the driver took no action or had no time to attempt any evasive maneuvers.

Actions taken by the driver, of this vehicle, *after realization* of an impending danger are captured in Attempted Avoidance Maneuver.

**[No Driver Present]**

is pre-coded if on the Official Records Tab the "Driver Present?" variable is coded as "No driver Present."

**Going straight**

is selected when this vehicle's path of travel was straight ahead without any attempted or intended changes.

**Decelerating in road**

is selected when this vehicle was traveling straight ahead within the road and was decelerating.

**Accelerating in road**

is selected when this vehicle was traveling straight ahead within the road and was accelerating.

**Starting in road**

is selected when this vehicle was in the process of starting forward from a stopped position within the road (*e.g.*, start up from traffic signal).

**Stopped in road**

is selected when this vehicle was stopped momentarily, with the motor running within the road (*e.g.*, stopped for traffic signal).

**Passing or overtaking another vehicle**

is selected when this vehicle was traveling straight ahead and was in the process of passing or overtaking another vehicle on the left or right.

**Disabled or parked in travel lane**

is selected when this vehicle was parked in a travel lane (*e.g.*, double parked, disabled) with a driver present in the vehicle.

**Leaving a parking position**

is selected when this vehicle was entering the travel lane from a parking area adjacent to the traffic lanes.

**Entering a parking position**

is selected when this vehicle was leaving the travel lane to a parking area adjacent to the traffic lanes (*i.e.*, in the process of parking).

**Turning right**

is selected when this vehicle was moving forward and turned right, changing lanes from one roadway to a different roadway (*e.g.*, from or to a driveway, parking lot, or intersection).

**Turning left**

is selected when this vehicle was moving forward and turned left, changing lanes from one roadway to a different roadway (*e.g.*, from or to a driveway, parking lot, or intersection).

**Making a U-turn**

is selected when this vehicle was making a U-turn on the trafficway.

**Backing up (other than for parking position)**

is selected when this vehicle was traveling backwards within the trafficway. Do not use this attribute if the vehicle was backing into a parking space (See **Entering parking position**)

**Negotiating a curve**

is selected when this vehicle was continuing along a road that curved to the right or left.

**Changing lanes**

is selected when this vehicle was traveling straight ahead and changed travel lanes to the right or left while on the same roadway.

**Merging**

is selected when this vehicle was moving forward and merging from the left or right into a traffic lane (*e.g.*, roadway narrows, exit/entrance ramps).

**Successful avoidance maneuver to a previous critical event**

is selected when this vehicle responded to a previous critical event and successfully avoided an impact. However, this maneuver precipitated a subsequent critical crash envelope, which resulted in this vehicle's first impact.

**Other (specify)**

is selected when this vehicle's pre-event movement is known but none of the specified attributes are applicable. The movement must be specified in the "specify box"

**Unknown**

is selected when the vehicle's movement prior to the driver's realization of an impending critical event is unknown.

**CRITICAL PRE CRASH CATEGORY**

**Screen Name:** Critical Pre Crash Category

**SAS Data Set:** N/A

**SAS Variable:** N/A

**Oracle Name:** *VEHICLEPRECRASH.PICKCRITICALCLASSEVENT*

**Element Attributes:**

Oracle	SAS
1	This Vehicle Loss of Control
2	This Vehicle Traveling
3	Other Motor Vehicle In Lane
4	Other Motor Vehicle Encroaching Into Lane
5	Pedestrian or Pedalcyclist, or Other Nonmotorist
6	Object or Animal
7	Other (Specify)
8	Unknown

**Source:** Researcher determined — inputs include scene inspection, vehicle inspection, driver interview, and police report.

**Remarks:**

When more than one condition applies and it cannot be determined which one had a greater effect, choose the higher listed element (i.e., **This Vehicle Loss of Control** takes precedence over **This Vehicle Traveling**).

**This Vehicle Loss of Control**

These identify situations where the critical factor leading to the collision involved control loss of this vehicle. Control loss can be related to either mechanical failure or environmentally induced vehicle instability.

**This Vehicle Traveling**

These identify situations where the critical factor leading to the collision involves the travel path of this vehicle.

**Other Motor Vehicle In Lane**

These identify situations where the critical factor leading to the collision involved the travel of the other vehicle in the same lane as this vehicle.



**Other Motor Vehicle Encroaching Into Lane**

These identify situations where the critical factor leading to the collision involves the other vehicle's movement into or across this vehicle's travel lane from another lane, intersection, driveway, or ramp.

**Pedestrian or Pedalcyclist, or Other Nonmotorist**

These identify situations where the critical factor leading to the collision for this vehicle involved a pedestrian, pedalcyclist, or other nonmotorist. A pedalcyclist is defined as a person riding a pedal power conveyance (*e.g.*, bicycle, tricycle, etc.). A nonmotorist is defined as a person riding on or in a conveyance which is not motorized or propelled by pedaling (*e.g.*, baby carriage, skate board, roller blades, etc.).

**Object or Animal**

These identify situations where the critical factor leading to the collision for this vehicle involved an object or animal.

**Other (Specify)**

is selected when a critical factor not previously listed resulted in the collision for this vehicle. Previous impacts in the crash are not considered as other critical precrash events. For example, use this attribute if the critical event developed from this vehicle's departure from a driveway.

**Unknown**

is selected when the critical precrash event which resulted in the collision is not known. Missing interviews do not automatically result in the use of the "Unknown" attribute.

**CRITICAL PRECRASH EVENT**

**Screen Name:** Critical Precrash Event

**SAS Data Set:** *GV*

**SAS Variable:** *PREEVENT*

**Oracle Name:** *VEHICLEPRECRASH.PICKCRITICALEVENT*

**Element Attributes:**

***This Vehicle Loss of Control Due To:***

Oracle	SAS
1	1 Blow out/flat tire
2	2 Stalled engine
3	3 Disabling vehicle failure ( <i>e.g.</i> , wheel fell off)
(specify):	
4	4 Non-disabling vehicle problem ( <i>e.g.</i> , hood flew up) (specify)
5	5 Poor road conditions (puddle, pot hole, ice, etc.) (specify)
6	6 Traveling too fast for conditions
	Cargo Shift
	Jackknife
8	8 Other cause of control loss (specify)
9	9 Unknown cause of control loss

***This Vehicle Traveling***

Oracle	SAS
10	10 Over the lane line on left side of travel lane
11	11 Over the lane line on right side of travel lane
12	12 Off the edge of the road on the left side
13	13 Off the edge of the road on the right side
14	14 End departure
15	15 Turning left at junction
16	16 Turning right at junction
17	17 Crossing over (passing through) junction
18	18 This vehicle decelerating
19	19 Unknown travel direction

***Other Motor Vehicle In Lane***

Oracle	SAS
50	50 Other vehicle stopped
51	51 Traveling in same direction with lower or steady speed
52	52 Traveling in same direction while decelerating
53	53 Traveling in same direction with higher speed
54	54 Traveling in opposite direction
55	55 In crossover
56	56 Backing
59	59 Unknown travel direction of other motor vehicle in lane

***Other Motor Vehicle Encroaching Into Lane***

60	60 From adjacent lane (same direction)—over left lane line
----	--

***Other MV Encroaching Into Lane cont'd***

Oracle	SAS
61	61 From adjacent lane (same direction)—over right lane line
62	62 From opposite direction over left lane line
63	63 From opposite direction over right lane line
64	64 From parking lane/shoulder
65	65 From crossing street, turning into same direction
66	66 From crossing street, across path
67	67 From crossing street turning into opposite direction
68	68 From crossing street, intended path not known
70	70 From driveway, turning into same direction
71	71 From driveway, across path
72	72 From driveway, turning into opposite direction
73	73 From driveway, intended path not known
74	74 From entrance to limited access highway
78	78 Encroachment by other vehicle—details unknown

***Pedestrian or Pedalcyclist, or Other Nonmotorist***

Oracle	SAS
80	80 Pedestrian in road
81	81 Pedestrian approaching road
82	82 Pedestrian unknown location
83	83 Pedalcyclist or other nonmotorist in road (specify)
84	84 Pedalcyclist or other nonmotorist approaching road (specify)
85	85 Pedalcyclist or other nonmotorist—unknown location (specify)

***Object or Animal***

Oracle	SAS
87	87 Animal in road
88	88 Animal approaching road
89	89 Animal—unknown location
90	90 Object in road
91	91 Object approaching road
92	92 Object unknown location

***Other (specify)***

112	98 Other critical precrash event (specify):
111	99 Unknown

**Source:** Researcher determined — inputs include scene inspection, vehicle inspection, driver interview, and police report.

**Remarks:**

The selection of the **Critical Precrash Category** will determine what **Critical Precrash Events** are available to select.

When more than one condition applies and it cannot be determined which one had a greater effect, choose the higher listed element.

This variable identifies the critical event which made the crash imminent (*i.e.*, something occurred which made the collision possible). Responsive actions to this situation, if any, are coded under **Attempted Avoidance Maneuver**.

A precrash event is coded for each vehicle and identifies the circumstances leading to this vehicle's first impact in the crash.

Do not refer to culpability. Many crash scenarios will suggest fault, but this should be coincidental rather than by design. As an example, vehicle 1 was speeding when vehicle 2 crossed vehicle 1's path from a driveway. The situation which made the precrash event critical for vehicle 1 (since it did not lose control) was vehicle 2's movement across vehicle 1's path **and not** vehicle 1's speed.

***This Vehicle Loss Of Control*****Blow out or flat tire**

is used when a vehicle in motion loses control as the result of an immediate tire disruption. Examples include blow out, rapid air loss, tread separation, etc..

**Stalled engine**

refers to a vehicle which is in motion and loses engine power. A stalled engine situation must precipitate a collision to be coded in this variable. A vehicle which is stopped as the result of an engine malfunction does not take this attribute.

**Disabling vehicle failure (*e.g.*, wheel fell off)**

is selected when a mechanical malfunction, such as a component of the vehicle suspension or steering system, leads to the critical reason for the collision. Specify which component failure was involved in the space provided under this element.

**Non-disabling vehicle problem (*e.g.*, hood flew up)**

is selected when some mechanical abnormality occurred to this vehicle which leads to the critical reason for the collision. The abnormality must not be disabling damage. A space is provided under this element to specify the non-disabling vehicle problem.

**Poor road conditions (puddle, pot hole, ice, etc.)**

captures control loss due to environmental conditions of the roadway. These conditions must have initiated the precrash event which resulted in the collision. A space is provided under this element to specify the road condition attributed to initiating the precrash event.

**Traveling too fast for conditions**

identifies this vehicle's movement relative to its surroundings in which the subsequent loss of control lead to the collision. An example is a roadway departure on a curve where the driver failed to negotiate and departed the roadway resulting in an impact. If the driver merely steered straight while in a curve and departed the roadway, then the category **This Vehicle Traveling** may apply.

**Other cause of control loss, specify**

is selected when it was determined that this vehicle's loss of control was the primary reason which made the event critical and the above attributes do not adequately identify the control loss condition. The condition cited should be annotated in the space provided.

**Unknown cause of control loss**

is selected when it is known control loss made the situation critical, but it is not known whether the vehicle or the environment caused the control loss.

**This Vehicle Traveling**

The attributes identify situations where the critical factor leading to the collision involving the travel path of this vehicle.

**Over the lane line on left side of travel lane**

is selected when this vehicle departs its lane to the left and is entering or had entered the adjoining lane or shoulder. The change of travel path by this vehicle must precipitate the critical event for the collision. As an example, this vehicle attempts to pass another vehicle on the other vehicle's left and is struck by a vehicle traveling within its travel lane in the opposite direction.

However, by modifying the scenario slightly, the lane change may not always be the factor leading to the precrash event. Consider the same situation where this vehicle is passing to the left of the lead vehicle. If an animal runs into the roadway and is struck by this vehicle, then the correct choice would be **Animal in road**.

**Over the lane line on right side of travel lane**

is selected when this vehicle departs its lane to the right and is entering or had entered the adjoining lane or shoulder. To use this attribute, change of travel path by this vehicle must precipitate the critical event for the collision. As an example, this vehicle attempts to pass another vehicle on the other vehicle's right and is struck in the rear by a vehicle traveling within its travel lane in the same direction. The correct choice for this vehicle would be **Over the lane line on right side of travel lane**.

However, by modifying the scenario slightly the lane change may not always be the factor leading to the precrash event. Consider the same situation where this vehicle is passing to the right of the lead vehicle. If an animal runs into the roadway and is struck by this vehicle, then the correct choice would be **Animal in road**.

**Off the edge of the road on the left side**

identifies a situation where the initial precrash event occurred beyond the left side shoulder area. This also includes departure into a median.

**Off the edge of the road on the right side**

identifies a situation where the initial precrash event occurred beyond the right side shoulder area.

**End departure**

is selected when the vehicle departs the end of the roadway (*e.g.*, "T" intersection).

**Turning left at junction**

is selected when this vehicle attempts a left turn from its roadway to another roadway or driveway.

**Turning right at junction**

is selected when this vehicle attempts a right turn from its roadway to another roadway or driveway.

**Crossing over (passing through) junction**

identifies this vehicle's travel as proceeding through the junction without any planned turning.

**This vehicle decelerating**

is selected when the vehicle is decelerating.

**Unknown travel direction**

is selected for those occasions where this vehicle's travel made the situation critical, but it is unknown which travel direction this vehicle was moving.

**Other Motor Vehicle In Lane**

These attributes identify situations where the critical factor leading to the collision involved the travel of the other vehicle in the same lane as this vehicle.

**Other vehicle stopped**

identifies a situation where the other vehicle is not in motion (*i.e.*, stopped, parked, disabled) and in this vehicle's travel lane.

**Traveling in same direction with lower steady speed**

is selected when the other vehicle was the lead vehicle in the same travel lane, traveling in the same direction, and was traveling slower than this vehicle

**Traveling in same direction while decelerating**

is selected when the other vehicle was the lead vehicle in the same travel lane, traveling in the same direction, and was decelerating.

**Traveling in same direction with higher speed**

is selected when the speed of the other vehicle was higher than this vehicle or accelerating. The other vehicle must be overtaking this vehicle.

**Traveling in opposite direction**

is selected when the other vehicle was in this vehicle's travel lane and traveling head-on in the opposite direction of this vehicle.

**In crossover**

is selected when the other vehicle enters a crossover already occupied by this vehicle. A crossover is defined as a designated opening within a median used primarily for "U-turns".

**Backing**

identifies a situation where the other vehicle was in the process of backing up while in this vehicle's travel lane.

**Unknown travel direction of other motor vehicle in lane**

is selected for situations where the other vehicle's activity (while in the same lane as this vehicle) precipitated the precrash event, but the travel direction and/or speed could not be determined.

**Other Motor Vehicle Encroaching Into Lane**

These attributes identify situations where the critical factor leading to the collision involves the other vehicle's movement into or across this vehicle's travel lane from another lane, intersection, driveway, or ramp.

**From adjacent lane (same direction)—over left lane line**

is selected when the other vehicle was traveling in the same direction as this vehicle and crosses the left lane line with respect to this vehicle's travel lane (*i.e.*, other vehicle crosses its right lane line).

**From adjacent lane (same direction) — over right lane line**

is selected when the other vehicle was traveling in the same direction as this vehicle and crosses the right lane line with respect to this vehicle's travel lane (*i.e.*, other vehicle crosses its left lane line).

**From opposite direction — over left lane line**

identifies a situation where the other vehicle crosses the left lane line while traveling in the opposite direction from this vehicle.

**From opposite direction — over right lane line**

identifies a situation where the other vehicle crosses the right lane line while traveling in the opposite direction from this vehicle.

**From parking lane/shoulder**

is selected when the other vehicle was departing a parking lane, shoulder, median or roadside and entering the travel lane of this vehicle.

**From crossing street, turning into same direction**

is selected when the other vehicle was turning from another roadway onto this vehicle's roadway and attempted to travel in the same direction as this vehicle.

**From crossing street, across path**

is selected when the other vehicle was continuing straight through the intersection and attempted to cross over this vehicle's roadway.

**From crossing street, turning into opposite direction**

is selected when the other vehicle was entering an intersection from another roadway and was turning or attempting to turn onto this vehicle's roadway in the opposite travel direction of this vehicle.

**From crossing street, intended path not known**

is selected when the other vehicle's entrance into the intersection was the critical factor which led to the collision, however, the other vehicle's travel direction could not be determined.

**From driveway, turning into same direction**

is selected when the other vehicle was turning from a driveway onto this vehicle's roadway and attempted to travel in the same direction as this vehicle.

**From driveway, across path**

is selected when the other vehicle was entering this vehicle's roadway from a driveway and was continuing straight across to another driveway or roadway.

**From driveway, turning into opposite direction**

is selected when the other vehicle was entering this vehicle's roadway from a driveway and was attempting to turn into the opposite travel direction of this vehicle.

**From driveway, intended path not known**

is used to identify driveway-related precrash events where details surrounding the other vehicle's intended path are not known.

**From entrance to limited access highway**

is selected for entrance ramp situations where the other vehicle was attempting to enter (merge) onto the limited access highway which was being traveled by this vehicle.

**Encroachment by other vehicle — details unknown**

is selected for situations where the other vehicle initiated the critical precrash event, but circumstances surrounding the other vehicle's encroachment are not known.

**Pedestrian or Pedalcyclist, or Other Nonmotorist**

These attributes identify situations where the critical factor leading to the collision for this vehicle involved a pedestrian, pedalcyclist, or other nonmotorist. A pedalcyclist is defined as a person riding a pedal power conveyance (*e.g.*, bicycle, tricycle, etc.). A nonmotorist is defined as a person riding on or in a conveyance which is not motorized or propelled by pedaling (*e.g.*, baby carriage, skate board, roller blades, etc.).

**Pedestrian in road**

is selected when a pedestrian was present (*e.g.*, sitting, standing, walking, or running, etc.) in the road.

**Pedestrian approaching road**

identifies situations where a pedestrian was within the trafficway and moving toward the road or attempting to enter the road, but was not on the road.

**Pedestrian — unknown location**

is selected when it was determined the presence or action of a pedestrian was the critical factor which led to this vehicle's collision, but the location or action of the pedestrian was not known.

**Pedalcyclist or other nonmotorist in road, (specify)**

is selected when a pedalcyclist or other nonmotorist was present in the road (irrespective of relative motion).

**Pedalcyclist or other nonmotorist approaching road, (specify)**

identifies situations where the pedalcyclist or other nonmotorist was within the trafficway and moving toward the road or attempting to enter the road, but was not on the road.

**Pedalcyclist or other nonmotorist — unknown location, (specify)**

is selected when it was determined the presence or action of a pedalcyclist or other nonmotorist was the critical factor which led to this vehicle's collision, but the action of the pedalcyclist or other nonmotorist was not known.



**Object or Animal**

These attributes identify situations where the critical factor leading to the collision for this vehicle involved an object or animal.

**Animal in road**

is selected when an animal was present (*i.e.*, stationary or moving) in the road.

**Animal approaching road**

identifies situations where an animal was within the trafficway and moving toward the road or attempting to enter the road, but not on the road.

**Animal - unknown location**

is selected when it was determined the presence or action of an animal was the critical factor which led to this vehicle's collision, but the action of the animal was not known.

**Object in road**

is used when an object was present in the road. An object is defined as being either fixed or nonfixed (**only non-fixed objects are captured in this attribute**).

**Object approaching road**

identifies situations where an object was within the trafficway and moving toward the road, but not on the road.

**Object — unknown location**

is selected when it was determined the presence or movement of an object was the critical factor which led to this vehicle's collision, but details surrounding the location of the object were not known.

**Other (specify)**

These attributes identify situations where the critical factor leading to the collision for this vehicle was not previously listed.

**Other Critical Precrash Event(specify)**

is selected when a critical factor not previously listed resulted in the collision for this vehicle. Previous impacts in the crash **are not** considered as "other critical precrash events". For example, use this code if the critical event developed from this vehicle's departure from a driveway.

**Unknown**

is selected when the critical precrash event which resulted in the collision is not known. Missing interviews **do not** automatically result in the use of this "Unknown" code.

**Precrash Event Scenarios for Different Rear-End Collision Situations**

Two Vehicle Collisions

		Trail Vehicle		Lead Vehicle	
1)	Both vehicles in motion. Leading vehicle, traveling at steady speed, is struck from behind by trailing vehicle.	Pre-Event Movement	Going straight	Going straight	Going straight
		Critical Precrash Category	Other Motor Vehicle In Lane	Other Motor Vehicle In Lane	Other Motor Vehicle In Lane
		Critical Precrash Event	Traveling in same direction with lower steady speed	Traveling in same direction with higher speed	Traveling in same direction with higher speed
2)	Both vehicles traveling at same speed. Lead vehicle decelerates and trailing vehicle continues at initial speed. Trailing vehicle eventually applies brakes before striking the lead vehicle.	Pre-Event Movement	Going straight	Going straight	Going straight
		Critical Precrash Category	Other Motor Vehicle In Lane	This Vehicle Traveling	This Vehicle Traveling
		Critical Precrash Event	Traveling in same direction while decelerating	Traveling in same direction while decelerating	This vehicle decelerating
3)	Both vehicles traveling at same speed. Lead vehicle stops and is immediately struck by trailing vehicle.	Pre-Event Movement	Going straight	Going straight	Going straight
		Critical Precrash Category	Other Motor Vehicle In Lane	Other Motor Vehicle In Lane	Other Motor Vehicle In Lane
		Critical Precrash Event	Traveling in same direction while decelerating	Traveling in same direction while decelerating	Traveling in same direction with higher speed
4)	Lead vehicle is stopped on roadway and is struck by a trailing vehicle.	Pre-Event Movement	Going straight	Stopped in traffic	Stopped in traffic
		Critical Precrash Category	Other Motor Vehicle In Lane	Other Motor Vehicle In Lane	Other Motor Vehicle In Lane
		Critical Precrash Event	Other vehicle stopped	Other vehicle stopped	Traveling in same direction with higher speed
5)	Lead and trailing vehicle stopped on roadway. Lead vehicle backs into trailing vehicle.	Pre-Event Movement	Stopped in traffic lane	Stopped in traffic lane	Stopped in traffic lane
		Critical Precrash Category	Other Motor Vehicle In Lane	Other Motor Vehicle In Lane	Other Motor Vehicle In Lane
		Critical Precrash Event	Backing	Backing	Other vehicle stopped

Coding Critical Precrash Event Scenerios for Different Rear-End Collision Situations cont'd

Three Vehicle Collisions

			<b>Trail Vehicle</b>	<b>Middle Vehicle</b>	<b>Lead Vehicle</b>
6)	Two vehicles stopped in traffic, struck by decelerating trailing vehicle	Pre-Event Movement	Decelerating	Stopped in traffic	Stopped in traffic
		Critical Precrash Category	Other Motor Vehicle In Lane	Other Motor Vehicle In Lane	Other Motor Vehicle In Lane
		Critical Precrash Event	Other vehicle stopped	Traveling in same direction while decelerating	Traveling in same direction with higher speed
7)	Lead vehicle stopped in traffic, middle vehicle decelerating, trailing vehicle strikes middle vehicle which strikes lead vehicle.	Pre-Event Movement	Going straight	Decelerating	Stopped in traffic
		Critical Precrash Category	Other Motor Vehicle In Lane	Other Motor Vehicle In Lane	Other Motor Vehicle In Lane
		Critical Precrash Event	Traveling in same direction while decelerating	Traveling in same direction with higher speed	Traveling in same direction with higher speed

**ATTEMPTED AVOIDANCE MANEUVER**

Page 1 of 2

**Screen Name:** Attempted Avoidance Maneuver**SAS Data Set:** *GV***SAS Variable:** *MANEUVER***Oracle Name:** *VEHICLEPRECRASH.ATTEMPTEDAVIDMANEUVER***Element Attributes:**

Oracle	SAS	
0	0	[No driver present]
1	1	No avoidance maneuver
2	2	Braking (no lockup)
3	3	Braking (lockup)
4	4	Braking (lockup unknown)
5	5	Releasing brakes
6	6	Steering left
7	7	Steering right
8	8	Braking and steering left
9	9	Braking and steering right
10	10	Accelerating
11	11	Accelerating and steering left
12	12	Accelerating and steering right
13	98	Other action (specify)
14	99	Unknown

**Source:** Researcher determined — all available sources of information**Remarks:**

Attempted avoidance maneuvers are movements/actions taken by the driver, within a *critical crash envelope*, in response to a Critical Precrash Event,. See **Precrash Data Overview** for an expanded discussion on precrash definitions. Attempted avoidance maneuvers occur *after* the driver has *realization* of an impending danger. This variable assesses what the driver's action(s) were in response to his/her realization.

Most crashes have only one critical crash envelope and thus only one Critical Precrash Event; however, multiple critical crash envelopes with their respective Critical Precrash Events, can exist.

This variable may be used independently: (1) of any maneuvers associated with this driver's Crash Type, and (2) this vehicle's first associated crash event.

Select the element value which best describes the actions taken by the driver in response to the Critical Precrash Event, within the *critical crash envelope* that occurred just prior to this vehicle's impact. When there was a known action (*e.g.*, braking), but you cannot determine whether there was more than one action (*e.g.*, braking and steering left), default to the known action (*e.g.*, braking).

**[No Driver Present]**

is pre-coded if on the Official Records Tab the "Driver Present?" variable is coded as "No driver Present".

**No avoidance maneuver**

is selected whenever the driver did not attempt any evasive (pre-impact) maneuvers.

**Braking (no lockup)**

is selected when there is no indication that the brakes locked up. This attribute can be used with vehicles equipped with anti-lock braking systems (ABS), that perform as designed.

**Braking (lockup)**

is selected when there is indication that the brakes locked up. This code is generally not a valid choice for vehicles with anti-lock braking systems (ABS), unless definite evidence of lockup exists.

## PRE-IMPACT STABILITY

Page 1 of 2

Screen Name: Pre-Impact Stability

SAS Data Set: GV

SAS Variable: PREISTAB

Oracle Name: VEHILCEPRECRASH.PICKPREIMPACTSTABILITY

## Element Attributes:

Oracle	SAS	
0	0	[No driver present]
1	1	Tracking
2	2	Skidding longitudinally rotation less than 30 degrees
3	3	Skidding laterally clockwise rotation
4	4	Skidding laterally counterclockwise rotation
5	8	Other vehicle loss-of-control (specify)
6	9	Pre-crash stability unknown

**Source:** Researcher determined — inputs include vehicle and scene evidence, interviews and police report.

**Remarks:**

The purpose of this variable is to assess the stability of the vehicle **after** the critical event, but before the impact. The stability of the vehicle prior to an avoidance action is not considered except in the following situation:

A vehicle that is out of control (*e.g.*, yawing clockwise) prior to an avoidance maneuver is coded as **Other vehicle loss-of-control** only if an avoidance action was taken in response to an impending danger.

Thus, this variable focuses upon this vehicle's dynamics after the critical event.

**[No Driver Present]**

is pre-coded if on the Official Records Tab the “Driver Present?” variable is coded as “No driver Present”.

**Tracking**

is used when there is no brake lockup and the vehicle continued along its intended path without rotation. Stopped, slowing, turning, or accelerating to avoid a rear-end collision are examples.

**Skidding longitudinally — rotation less than 30 degrees**

is selected when there is brake lockup or whenever tire marks are apparent without brake lockup (braking or non-braking) and rotation is less than 30 degrees clockwise or counterclockwise. If

there is no information to support rotation greater than or equal to 30 degrees, then use this attribute.

**Skidding laterally — clockwise rotation**

is selected when the vehicle rotates clockwise, relative to the driver's seating position. The vehicle must rotate 30 degrees or more. This attribute also applies when the driver attempts a steering input (*i.e.*, steers right), but the vehicle rotates clockwise.

**Skidding laterally — counterclockwise rotation**

is selected when the vehicle rotates counterclockwise, relative to the driver's seating position. The vehicle must rotate 30 degrees or more. This attribute also applies when the driver attempts a steering input (*i.e.*, swerves left), but the vehicle rotates counterclockwise.

**Other vehicle loss-of-control, (specify)**

is selected when a driver loses control of a vehicle prior to the critical event.

**Precrash stability unknown**

is selected when the stability of the vehicle, after the Critical Event, cannot be determined.

## PRE-IMPACT LOCATION

Page 1 of 2

Screen Name: Pre-Impact Location

SAS Data Set: *GV*SAS Variable: *PREILOC*Oracle Name: *VEHICLEPRECRASH.PICKPREIMPACTLOCATION*

## Element Attributes:

Oracle	SAS	
0	0	[No driver present]
1	1	Stayed in original travel lane
2	2	Stayed on roadway but left original travel lane
3	3	Stayed on roadway, not known if left original travel lane
4	4	Departed roadway
5	5	Remained off roadway
6	6	Returned to roadway
7	7	Entered roadway
8	9	Unknown

**Source:** Researcher determined — inputs include vehicle and scene evidence, interviews and police report.

**Remarks:**

The purpose of this variable is to assess the location of the vehicle **after** the critical event, but before the impact. Select the attribute which best describes the location of the vehicle (i.e., perimeter of the vehicle from the case diagram).

**[No Driver Present]**

is pre-coded if on the Official Records Tab the “Driver Present?” variable is coded as “No driver Present”.

**Stayed in original travel lane**

is selected when the vehicle remained within the boundaries of its initial travel lane.

**Stayed on roadway but left original travel lane**

is selected when the perimeter of the vehicle departed its initial travel lane; however, the vehicle remained within the boundaries of the roadway (travel lanes).



**Stayed on roadway, not known if left original travel lane**

is selected when it cannot be ascertained whether the vehicle remained within its initial travel lane. To use this attribute, the vehicle must have remained within the boundaries of the roadway.

**Departed roadway**

is selected when the vehicle departed the roadway as a result of a precrash motion. The roadway departure must not be related to the post-impact trajectory of a crash within the roadway. Use this attribute for vehicles crossing a median into oncoming traffic.

**Remained off roadway**

the precrash motion occurred outside the boundaries of the roadway. This includes traveling on the shoulders, within the median, on the roadside, or off the trafficway.

**Returned to roadway**

is selected when the vehicle was on the roadway, went off the roadway and then returned to the same roadway during precrash motion.

**Entered roadway**

is selected when the vehicle was not previously on the roadway and then the vehicle enters the roadway during precrash motion.

**Unknown**

the precrash motion of the vehicle cannot be determined.

## CRASH TYPE

Page 1 of 2

Screen Name: Crash Type

SAS Data Set: GV

SAS Variable: ACCTYPE

Oracle Name: VEHICLEPRECRASH.PICKACCIDENTTYPE

## Element Attributes:

Oracle	SAS	
		As assigned by the selection on the next screens
1	00	No Impact 01 - 93
3	98	Other Crash Type
4	99	Unknown
SEE FOLLOWING VARIABLES FOR CODES		

**Source:** Researcher determined — inputs include police report, scene inspection, vehicle inspection, and interview.

**Remarks:**

The Crash Type is a numeric value assigned by selecting the **Crash Category** and the **Crash Configuration** on the next screens/pages. The number can be directly entered or edited here, however, the two-step process of selecting the Crash Category And Crash Configuration is preferred to visualize the crash scenario.

The first harmful event may include a collision between a vehicle and some object, accompanied by property damage or human injury. The object may be another vehicle, a person, an animal, a fixed object, the road surface, or the ground. If the first collision is a rollover, the impact is with the ground or road surface. The collision may also involve plowing into soft ground, if severe vehicle deceleration results in damage or injury. A road departure without damage or injury is not defined as a harmful event.

Crash Type (cont'd)

Page 2 of 2

To access the category choices double click on the white box next to Crash Type and the following window opens:

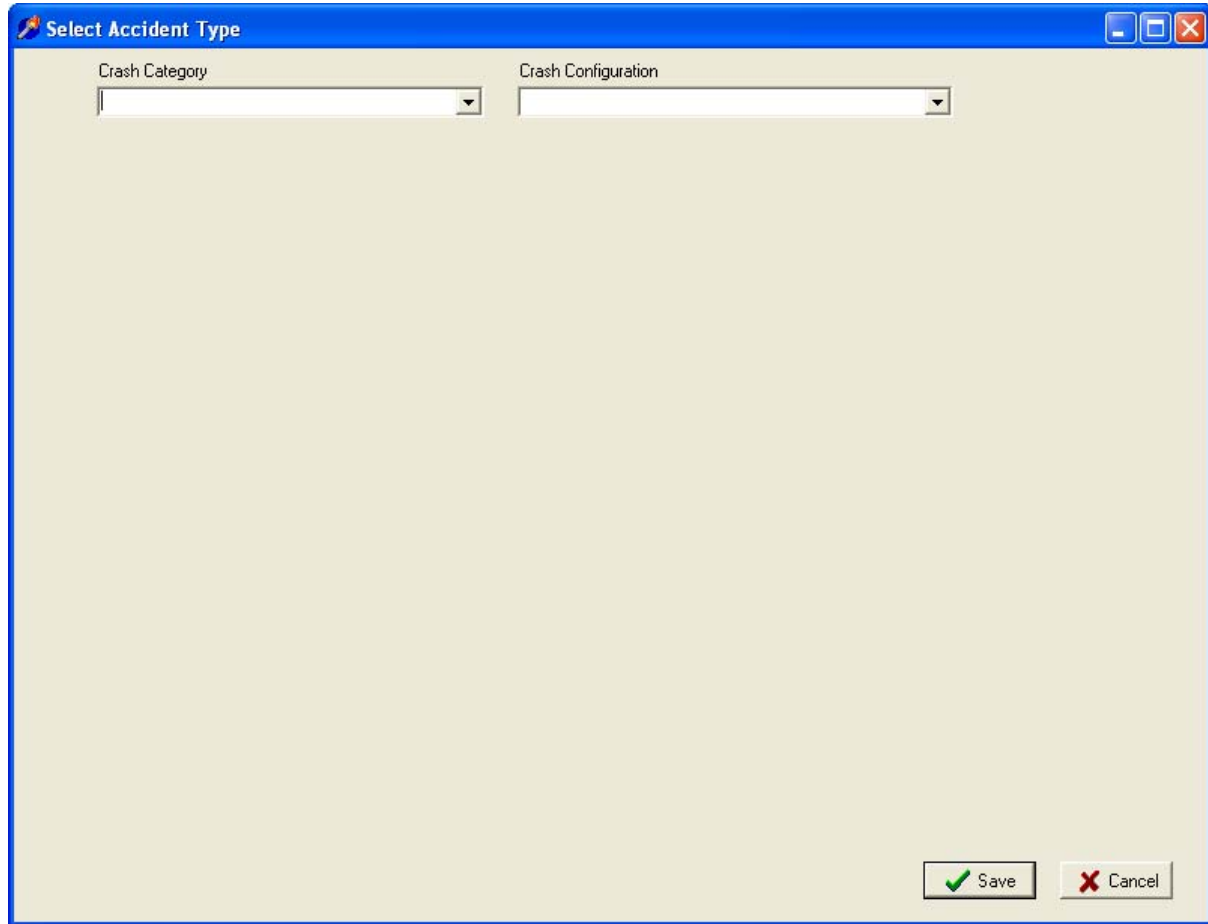

Category	Configuration	CRASH TYPES (includes intent)					
<b>I</b> Single Driver	<b>A</b> Right Roadside Departure	01 DRIVE OFF ROAD	02 CONTROL/ TRACTION LOSS	03 AVOID COLLISION WITH VEH., PED., ANIM.	04 SPECIFICS OTHER	05 SPECIFICS UNKNOWN	
	<b>B</b> Left Roadside Departure	06 DRIVE OFF ROAD	07 CONTROL/ TRACTION LOSS	08 AVOID COLLISION WITH VEH., PED., ANIM.	09 SPECIFICS OTHER	10 SPECIFICS UNKNOWN	
	<b>C</b> Forward Impact	11 PARKED VEH.	12 STA OBJECT	13 PEDESTRIAN/ ANIMAL	14 END DEPARTURE	15 SPECIFICS OTHER	16 SPECIFICS UNKNOWN
<b>II</b> Same Trafficway Same Direction	<b>D</b> Rear End	20 STOPPED 21, 22, 23	24 SLOWER 25, 26, 27	28 DECEL. 29, 30, 31	(EACH - 32) SPECIFICS OTHER	(EACH - 33) SPECIFICS UNKNOWN	
	<b>E</b> Forward Impact	34 CONTROL/ TRACTION LOSS	36 CONTROL/ TRACTION LOSS	38 AVOID COLLISION WITH VEH.	40 AVOID COLLISION WITH OBJECT	(EACH - 42) SPECIFICS OTHER	(EACH - 43) SPECIFICS UNKNOWN
	<b>F</b> Angle, Sideswipe	44 45	46 45 47	(EACH - 48) SPECIFICS OTHER	(EACH - 49) SPECIFICS UNKNOWN		
<b>III</b> Same Trafficway Opposite Direction	<b>G</b> Head-On	50 51	(EACH - 52) SPECIFICS OTHER	(EACH - 53) SPECIFICS UNKNOWN			
	<b>H</b> Forward Impact	54 CONTROL/ TRACTION LOSS	56 CONTROL/ TRACTION LOSS	58 AVOID COLLISION WITH VEH.	60 AVOID COLLISION WITH OBJECT	(EACH - 62) SPECIFICS OTHER	(EACH - 63) SPECIFICS UNKNOWN
	<b>I</b> Angle, Sideswipe	64 65 Lateral Moves	(EACH - 66) SPECIFICS OTHER	(EACH - 67) SPECIFICS UNKNOWN			
<b>IV</b> Change Trafficway Vehicle Turning	<b>J</b> Turn Across Path	68 69 Initial Opposite Directions	70 71 72 Initial Same Directions	(EACH - 74) SPECIFICS OTHER	(EACH - 75) SPECIFICS UNKNOWN		
	<b>K</b> Turn Into Path	76 77 78 79 Turn Into Same Direction	80 81 82 83 Turn Into Opposite Direction	(EACH - 84) SPECIFICS OTHER	(EACH - 85) SPECIFICS UNKNOWN		
<b>V</b> Intersect Paths	<b>L</b> Straight Paths	86 87 Struck on the Right	88 89 Struck on the Left	(EACH - 90) SPECIFICS OTHER	(EACH - 91) SPECIFICS UNKNOWN		
<b>VI</b> Misc.	<b>M</b> Backing, Etc.	92 93 Backing Veh. or Object	98 OTHER CRASH TYPE	99 UNKNOWN CRASH TYPE	00 NO IMPACT		

**CRASH CATEGORY**

Page 1 of 2

**Screen Name:** Crash Category**SAS Data Set:** N/A**SAS Variable:** N/A**Oracle Name:** N/A**Element Attributes:**

Oracle SAS

Single Driver  
Same Trafficway, Same Direction  
Same Trafficway, Opposite Direction  
Changing Trafficway, Vehicle Turning  
Intersecting Paths (Vehicle Damage)  
Miscellaneous

**Remarks:**

Variables Crash Type (Category) and Crash Type (Configuration); are used for categorizing the collisions of drivers involved in crashes. A collision is defined here as the first harmful event in a crash between a vehicle and some object, accompanied by property damage or human injury. The object may be another vehicle, a person, an animal, a fixed object, the road surface, or the ground. The first harmful event may also involve plowing into soft ground, if severe vehicle deceleration results in damage or injury. A road departure without damage or injury is not defined as a collision.

To determine the proper crash type, refer to the three step decision process outlined below:

- Step 1 - Determine the appropriate Crash Category.
- Step 2 - Determine the appropriate Crash Configuration.
- Step 3 - Determine the specific Crash Type from the graphic icons .

The attributes for this variable are the categories. The configuration and specific crash type attributes are further discussed under variables Crash Configuration, and Crash Type.

The definitions of each of the six categories are as follows:

**Single Driver**

The first harmful event involves a collision between an in-transport vehicle and an object, or an off roadway rollover. A harmful event involving two in-transport vehicles is excluded from this category. Note, the impact location on the vehicle is not a consideration for crash types in this category.

Crash Category (cont'd)

Page 2 of 2

**Same Trafficway, Same Direction**

The first harmful event occurred while both vehicles were traveling in the same direction on the same trafficway.

**Same Trafficway, Opposite Direction**

The first harmful event occurred while both vehicles were traveling in opposite directions on the same trafficway.

**Change Trafficway, Vehicle Turning**

The first harmful event occurred when the vehicle is either turning or merging while attempting to change from one trafficway to another trafficway. Trafficway for this variable is loosely defined to include driveways, alleys and parking lots when a vehicle is either entering or exiting a trafficway.

**Intersecting Paths (Vehicle Damage)**

The first harmful event involves situations where vehicle trajectories intersect. It is important to note the location of damage to each vehicle for crash typing. The location of damage to each vehicle is important to determine the correct crash type.

**Miscellaneous**

The first harmful event involves a crash type which cannot be described in the Categories above and thus is included in this category. Select this category, if there is insufficient information to choose between categories. Included are vehicles that are backing, third or subsequent vehicles involved in the crash, U-turns, etc.

Each category is subdivided into crash configuration(s). The configurations are described under **Crash Configuration**.

**CRASH CONFIGURATION**

**Screen Name:** Crash Configuration

**SAS Data Set:** N/A

**SAS Variable:** N/A

**Oracle Name:** N/A

**Element Attributes:**

Oracle SAS

**Single Driver**

Right Roadside Departure

Left Roadside Departure

Forward Impact

**Same Trafficway, Same Direction**

Rear-End

Forward Impact

Sideswipe/Angle

**Same Trafficway, Opposite Direction**

Head-On

Forward Impact

Sideswipe/Angle

**Change Trafficway Vehicle Turning**

Turn Across Path

Turn Into Path

**Intersecting Paths (Vehicle Damage)**

Straight Paths

**Miscellaneous**

Backing, Etc.

**Source:** Researcher determined — inputs include police report, scene inspection, vehicle inspection, and interview.

**Remarks:**

Each category is further defined by a Crash Configuration. The Configurations are discussed below.

## Single Driver

***Right Roadside Departure; Left Roadside Departure*** - The vehicle departed either the right or left side of road with the first harmful event occurring off the road. Right versus left is based on the side of the road departed immediately prior to the first harmful event.

***Forward Impact*** - The vehicle struck an object on the trafficway while moving forward.

## Same Trafficway, Same Direction

***Rear-End*** — The front of the overtaking vehicle impacted the rear of the other vehicle. **Note**, even if the rear-impacted vehicle had started to make a turn, code here (not in **Change Trafficway Vehicle Turning**).

***Forward Impact*** — The front of the overtaking vehicle impacted the rear of the other vehicle, following a steering maneuver around a noninvolved vehicle or object.

***Sideswipe/Angle*** — The two vehicles are involved in a shallow, glancing impact involving the side of one or both vehicles. **Note**, CDC guidelines for sideswipes are not considered when assessing this configuration.

## Same Trafficway, Opposite Direction

***Head-On*** — The frontal area of one vehicle impacted the frontal area of another.

***Forward Impact*** — The frontal area of one vehicle impacted the frontal area of another following a steering maneuver around a noninvolved vehicle or an object.

***Sideswipe/Angle*** — The two vehicles are involved in a shallow, glancing impact involving the side of one or both vehicles.

## Changing Trafficway, Vehicle Turning

***Turn Across Path*** — The two vehicles were initially on the same trafficway when one vehicle tried to turn onto another trafficway and pulled ***in front of*** the other vehicle. Vehicles making a "U" turn are identified in **Miscellaneous**.

***Turn Into Path*** — The two vehicles were initially on different trafficways when one attempted to turn into the same trafficway as the other vehicle. **Note**, the focus of this configuration is on the turning maneuver from one trafficway to another and not on the vehicles' plane of contact.



**Intersecting Paths (Vehicle Damage)**

*Straight Paths* — The two vehicles were proceeding (or attempting to proceed) straight ahead.

**Miscellaneous**

*Backing, Etc.* — One of the two vehicles involved was a backing vehicle, regardless of its location on the trafficway or the damage location on the vehicles. Any crash configuration which cannot be described in the categories above is included here (e.g., U-turns, third or subsequent vehicles involved in the crash, etc.).

**CRASH TYPES**

**Screen Name:** Crash Types

**SAS Data Set:** *GV*

**SAS Variable:** *ACCTYPE*

**Oracle Name:** *VEHICLEPRECRASH.PICKACCIDENTTYPE*

**Element Values:**

**Crash Category: Single Driver**

Crash Configuration Right Roadside Departure:

Oracle	SAS	
01	01	Drive Off Road
02	02	Control/Traction Loss
03	03	Avoid Collision with Vehicle, Pedestrian, Animal
04	04	Specifics Other
05	05	Specifics Unknown

Crash Configuration Left Roadside Departure

06	06	Drive Off Road
07	07	Control/Traction Loss
08	08	Avoid Collision With Vehicle, Pedestrian, Animal
09	09	Specifics Other
10	10	Specifics Unknown

Crash Configuration Forward Impact

11	11	Parked Vehicle
12	12	Stationary Object
13	13	Pedestrian/Animal
14	14	End Departure
15	15	Specifics Other
16	16	Specifics Unknown

**Crash Category: Same Trafficway, Same Direction**

Crash Configuration Rear-End

20	20	Stopped
21	21	Stopped, Straight
22	22	Stopped, Left
23	23	Stopped, Right
24	24	Slower
25	25	Slower, Going Straight
26	26	Slower, Going Left
27	27	Slower, Going Right

Crash Types (cont'd)

Oracle	SAS	
28	28	Decelerating (Slowing)
29	29	Decelerating (Slowing), Going Straight
30	30	Decelerating (Slowing), Going Left
31	31	Decelerating (Slowing), Going Right
32	32	Specifics Other
33	33	Specifics Unknown

Crash Configuration: Forward Impact

34	34	This Vehicle's Frontal Area Impacts Another Vehicle
35	35	This Vehicle Is Impacted by Frontal Area of Another Vehicle
36	36	This Vehicle's Frontal Area Impacts Another Vehicle
37	37	This Vehicle Is Impacted by Frontal Area of Another Vehicle
38	38	This Vehicle's Frontal Area Impacts Another Vehicle
39	39	This Vehicle Is Impacted by Frontal Area of Another Vehicle
40	40	This Vehicle's Frontal Area Impacts Another Vehicle
41	41	This Vehicle Is Impacted by Frontal Area of Another Vehicle
42	42	Specifics Other
43	43	Specifics Unknown

Crash Configuration: Sideswipe/Angle

44	44	Straight Ahead on Left
45	45	Straight Ahead on Left/Right
46	46	Changing Lanes to the Right
47	47	Changing Lanes to the Left
48	48	Specifics Other
49	49	Specifics Unknown

**Crash Category: Same Trafficway Opposite Direction**

Crash Configuration: Head-On

50	50	Lateral Move (Left/Right)
51	51	Lateral Move (Going Straight)
52	52	Specifics Other
53	53	Specifics Unknown

Crash Configuration: Forward Impact

55	54	This Vehicle's Frontal Area Impacts Another Vehicle
55	55	This Vehicle Is Impacted by Frontal Area of Another Vehicle
56	56	This Vehicle's Frontal Area Impacts Another Vehicle
57	57	This Vehicle Is Impacted by Frontal Area of Another Vehicle
58	58	This Vehicle's Frontal Area Impacts Another Vehicle
59	59	This Vehicle Is Impacted by Frontal Area of Another Vehicle
60	60	This Vehicle's Frontal Area Impacts Another Vehicle

Crash Types (cont'd)

Oracle	SAS	
61	61	This Vehicle Is Impacted by Frontal Area of Another Vehicle
62	62	Specifics Other
63	63	Specifics Unknown

Crash Configuration: Sideswipe/Angle

64	64	Lateral Move (left/Right)
65	65	Lateral Move (Going Straight)
66	66	Specifics Other
67	67	Specifics Unknown

**Crash Category: Change Trafficway Vehicle Turning**

Crash Configuration: Turn Across Path

68	68	Initial Opposite Directions (Left/Right)
69	69	Initial Opposite Directions (Going Straight)
70	70	Initial Same Directions (Turning Right)
71	71	Initial Same Directions (Going Straight)
72	72	Initial Same Directions (Turning Left)
73	73	Initial Same Directions (Going Straight)
74	74	Specifics Other
75	75	Specifics Unknown

Crash Configuration: Turn Into Path

76	76	Turn Into Same Direction (Turning Left)
77	77	Turn Into Same Direction (Going Straight)
78	78	Turn Into Same Direction (Turning Right)
79	79	Turn Into Same Direction (Going Straight)
80	80	Turn Into Opposite Directions (Turning Right)
81	81	Turn Into Opposite Directions (Going Straight)
82	82	Turn Into Opposite Directions (Turning Left)
83	83	Turn Into Opposite Directions (Going Straight)
84	84	Specifics Other
85	85	Specifics Unknown

**Crash Category: Intersecting Paths (Vehicle Damage)**

Configuration Straight Paths

86	86	Striking from the Right
87	87	Struck on the Right
88	88	Striking from the Left
89	89	Struck on the Left
90	90	Specifics Other
91	91	Specifics Unknown

Crash Types (cont'd)

Page 4 of 25

**Crash Category: Miscellaneous**

Oracle	SAS	Crash Configuration: Backing, Etc.
92	92	Backing Vehicle
93	93	Other Vehicle or Object
98	98	Other Crash Type
99	99	Unknown Crash Type
00	00	No Impact

**Source:** Researcher determined — inputs include police report, scene inspection, vehicle inspection, and interview.

**Remarks:**

**Crash Category: Single Driver**

The crash types in **Single Driver** involve an impact between a vehicle and an object. The other Categories identify specific collision combinations which must be coded in specified pairs (*i.e.*, the pair attribute defines the Crash Type). As an example, the combination Rear-end, stopped and Rear-end, specifics other or Rear-end, stopped and Slower, straight ahead are not valid since Rear-end, stopped only has meaning when linked to Stopped.

A crash involving a vehicle impacting a "driverless in-transport vehicle" is coded "**, specifics other**" in the appropriate configuration-category. For example, a vehicle which impacts the rear of a driverless in-transport vehicle is encoded Rear-end, specifics other.

In crashes involving more than two vehicles or in collision sequences involving a combination of vehicle-to-object-to-vehicle impacts, code the Crash Type for the vehicle(s) involved in the first harmful event. All other vehicles are coded **Other Crash Type**.

Keep in mind that *intended actions* play an important role in the coding scheme. For example, crash type Slower, turning left is selected over type (Slower, straight ahead) if the subject vehicle was traveling slower with the *intention* of turning left. Note, the turning action need not have occurred prior to the collision. The driver's *intent* to turn is the key.

The *configurations* are delineated into specific crash types. These types can be identified by referring to the crash type diagrams.

Crash Category Single Driver cont'd

**Crash Configuration: Right Roadside Departure**

The vehicle departed the right side of the road with the first harmful event occurring off the road.

**01 Right Roadside Departure: Drive Off Road**

Enter "01" when the vehicle departed the road under a controlled situation (e.g. was distracted, fell asleep, intentionally departed, etc).

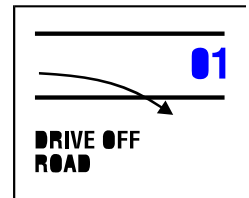

**02 Right Roadside Departure: Control/Traction Loss**

Enter "02" when there is evidence that the vehicle lost traction or "got away" from in some other way (e.g., the vehicle spun off the road as a result of surface conditions, oversteer phenomena, or mechanical malfunctions). If doubt exists, code "01" (Right Roadside Departure, Drive Off Road).

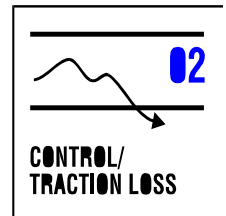

**03 Right Roadside Departure: Avoid Collision With Vehicle, Pedestrian,**

Enter "03" when the vehicle departed the road to avoid something on the road. Phantom vehicle situations, pedestrians, bicyclists, and other cyclists and nonmotorists are included here.

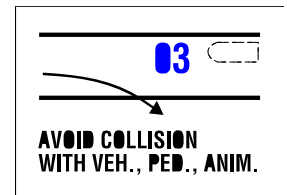

**04 Right Roadside Departure: Specifics Other**

Enter "04" if the vehicle departed the road to avoid something on the road other than a vehicle, pedestrian, or animal. Also use "Specifics Other" for crashes involving a driverless in-transport vehicle.



**05 Right Roadside Departure: Specifics Unknown**

Enter "05" if the vehicle departed the right side of the road for unknown reasons.



**Crash Configuration: Left Roadside Departure**

**06 Left Roadside Departure: Drive Off Road**

Enter "06" when the vehicle departed the road under a controlled situation (e.g., was distracted, fell asleep, intentionally departed, etc.)

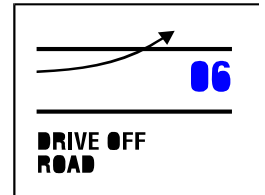

**07 Left Roadside Departure: Control/Traction Loss**

Enter "07" if there is evidence that the vehicle lost traction or "got away" from the driver in some other way (e.g., the vehicle spun off the road as a result of surface conditions, oversteer phenomena, or mechanical malfunctions.) If doubt exists, code "06" (Left Roadside Departure, Drive Off Road).

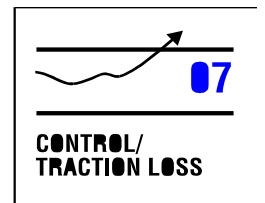

**08 Left Roadside Departure: Avoid Collision With Vehicle, Pedestrian, Animal**

Enter "08" when the vehicle departed the road to avoid something on the road. Phantom vehicle situations, pedestrians, bicyclists, and other cyclists and nonmotorists are included here.

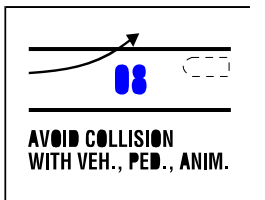

**09 Left Roadside Departure: Specifics Other**

Enter "09" if the vehicle departed the road to avoid something on the road other than a vehicle, pedestrian, or animal. Also, use "specifics Other" for crashes involving a driverless in-transport vehicle.



**10 Left Roadside Departure: Specifics Unknown**

Enter "10" if the vehicle departed the left side of the road for unknown reasons.



**Crash Configuration: Forward Impact**

The vehicle struck an object on the road or off the end of a trafficway while moving forward.

**11 Forward Impact: Parked Vehicle**

Enter "11" if the crash involves impact with a parked vehicle on either side of the road.



**12 Forward Impact: Stationary Object**

Enter "12" if the crash involves impact with a stationary object on either side of the road.

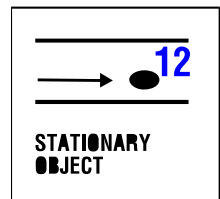

**13 Forward Impact: Pedestrian/Animal**

Enter "13" if the first harmful event involves impact with a pedestrian or animal on the road. Pedestrians, bicyclists, and other cyclists and nonmotorists are included here. Vehicle plane of contact is NOT a consideration.

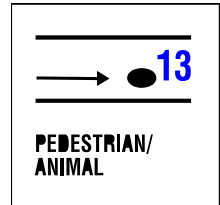

**14 Forward Impact: End Departure**

Enter "14" when the vehicle ran off the end of the road and crashed into something.

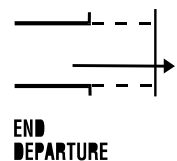

**15 Forward Impact: Specifics Other**

Enter "15" for impacted (striking or struck) railway vehicles and nonstationary objects on the road. Also use "Specifics Other" for crashes involving a driverless in-transport motor vehicles.

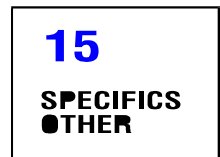

**16 Forward Impact: Specifics Unknown**

Enter "16" when the PAR indicates a single driver was involved in a forward impact collision, but no further classification is possible.



**Crash Category: Same Trafficway, Same Direction**

**Crash Configuration: Rear-End**

The front of the overtaking vehicle impacted the rear of the other vehicle. Note, even if the rear-impacted vehicle had started to make a turn, code here (**not** in Crash Category: Change in Trafficway, Vehicle Turning).

**20 Rear-End: Stopped**

Enter "20" for a vehicle that impacts another vehicle from the rear when the impacted vehicle was stopped in the trafficway.

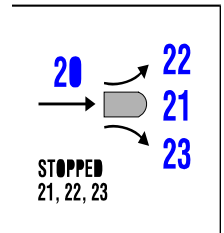

**21 Rear-End: Stopped, Straight**

Enter "21" for a rear-impacted vehicle that was stopped in the trafficway, and was intending to proceed straight ahead.

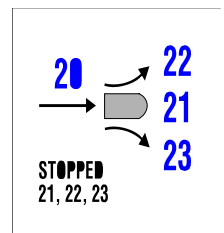

**22 Rear-End: Stopped, Left**

Enter "22" for a rear-impacted vehicle that was stopped in the trafficway, intending to make a left turn.

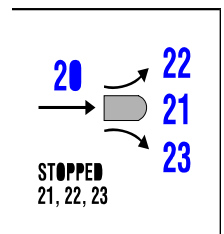

**23 Rear-End: Stopped, Right**

Enter "23" for a rear-impacted vehicle that was stopped in the trafficway, intending to make a right turn.

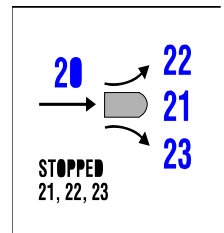

Crash Types (cont'd)

**24 Rear-End: Slower**

Enter "24" for a vehicle that impacts another vehicle from the rear when the impacted vehicle was going slower than the striking vehicle.

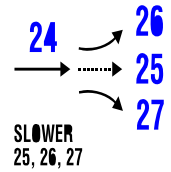

**25 Rear-End: Slower, Going Straight**

Enter "25" for a rear-impacted vehicle that was going slower than the other vehicle while proceeding straight ahead.

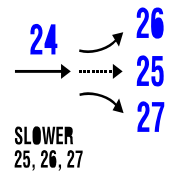

**26 Rear-End: Slower, Going Left**

Enter "26" for a rear-impacted vehicle that was going slower than the other vehicle while intending to turn left.

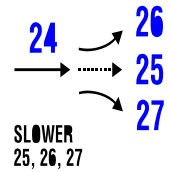

**27 Rear-End: Slower, Going Right**

Enter "27" for a rear-impacted vehicle that was going slower than the other vehicle while intending to turn right.

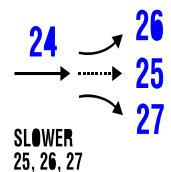

**28 Rear-End: Decelerating (Slowing)**

Enter "28" for a vehicle impacts another vehicle from the rear when the impacted vehicle was slowing down.

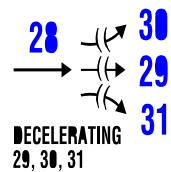

**29 Rear-End: Decelerating (Slowing), Going Straight**

Enter "29" for a rear-impacted vehicle that was slowing down while proceeding straight ahead.

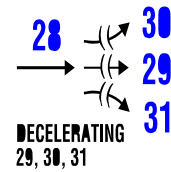

**30 Rear-End: Decelerating (Slowing), Going Left**

Enter "30" for a rear-impacted vehicle that was slowing down while intending to turn left.

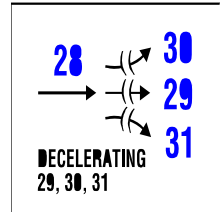

**31 Rear-End: Decelerating (Slowing), Going Right**

Enter "31" for a rear-impacted vehicle that was slowing down while intending to turn right.

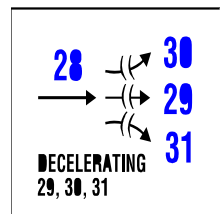

**32 Rear-End: Specifics Other**

Enter "32" for rear-end collisions which cannot be described in "20"- "31."  
Enter "Specifics Other" for crashes involving a driverless in-transport vehicle.



**33 Rear-End: Specifics Unknown**

Enter "33" when the PAR indicates a rear-end collision occurred, but no further classification is possible.



**Crash Configuration: Forward Impact**

The front of the overtaking vehicle impacted the rear of the other vehicle, following a steering maneuver around a noninvolved vehicle or object.

**34 Forward Impact: Control/Traction Loss**

Enter "34" for a vehicle that's frontal area impacts another vehicle due to loss of control or traction (during a maneuver to avoid a collision with a non-involved vehicle) while both are traveling on the same trafficway in the same direction.

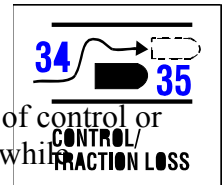

**35 Forward Impact: Control/Traction Loss**

Enter "35" for a vehicle which is impacted by the frontal area of another vehicle due to loss of control or traction (during a maneuver to avoid a collision with a non-involved vehicle) while both are traveling on the same trafficway in the same direction.

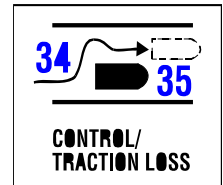

**36 Forward Impact: Control/Traction Loss**

Enter "36" for a vehicle that's frontal area impacts another vehicle due to loss of control or traction (during a maneuver to avoid a collision with an object) while both are traveling on the same trafficway in the same direction.

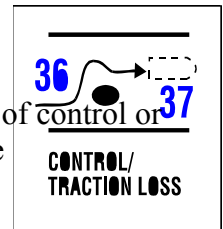

**37 Forward Impact: Control/Traction Loss**

Enter "37" for a vehicle which is impacted by the frontal area of another vehicle due to loss of control or traction (during a maneuver to avoid a collision with an object) while both are traveling on the same trafficway in the same direction.

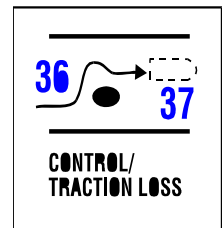

**38 Forward Impact: Avoid Collision with Vehicle**

Enter "38" for a vehicle that struck the rear of another vehicle with its front plane while maneuvering to avoid collision with a non-involved vehicle, when loss of control or traction was not a factor, and both were traveling on the same trafficway, in the same direction.

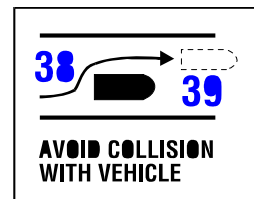

**39 Forward Impact: Avoid Collision with Vehicle**

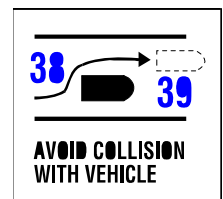

Enter "39" for a vehicle that was impacted by the frontal area of another vehicle which was maneuvering to avoid a collision with a non-involved vehicle, when loss of control or traction was not a factor, and both were traveling on the same trafficway, in the same direction.

**40 Forward Impact: Avoid Collision with Object**

Enter "40" for a vehicle that struck the rear of another vehicle with its front plane while maneuvering to avoid collision with an object, when loss of control or traction was not a factor, and both were traveling on the same trafficway, in the same direction.

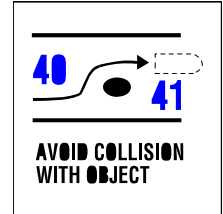

**41 Forward Impact: Avoid Collision with Object**

Enter "41" for a vehicle which was impacted by the frontal area of another vehicle which was maneuvering to avoid a collision with an object, when loss of control or traction was not a factor, and both were traveling on the same trafficway, in the same direction.

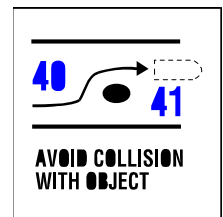

**42 Forward Impact: Specifics Other**

Enter "42" (for both vehicles) for a forward impact collision which occurred while both vehicles were traveling on the same trafficway, in the same direction, and the striking vehicle was attempting to avoid a vehicle or an object which cannot be described by "34" - "40."



Also, use this code for crashes involving a driverless in-transport vehicle which would otherwise qualify for this configuration.

**43 Forward Impact: Specifics Unknown**

Enter "43" when the PAR indicates that a forward impact collision occurred while both vehicles were traveling on the same trafficway and in the same direction, but no further classification was possible.

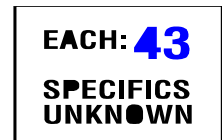

Crash Types (cont'd)

Page 13 of 25

**Crash Configuration: Sideswipe/Angle**

The two vehicles are involved in an impact involving the side of one or both vehicles.

The following four codes, "44" (Sideswipe/Angle, straight ahead on left), "45" (Sideswipe/Angle, straight ahead on left/right), "46" (Sideswipe/Angle, changing lanes to the right), "47" (Sideswipe/Angle, changing lanes to the left), identify relative vehicle positions (left versus right) and lane of travel intentions (straight ahead versus changing lanes). From these four codes, four combinations are permitted. They are:

1. "44" and "45"
2. "46" and "45"
3. "45" and "47"
4. "46" and "47".

When used in combination, these codes refer to a sideswipe or angle collision which involved a vehicle to the left of a vehicle to the right where:

1. neither vehicle (codes "44" and "45") intended to change its lane;
2. the vehicle on the left (code "46") was changing lanes to the right, and the vehicle on the right (code "45") was not intending to change its lane;
3. the vehicle on the left (code "45") was not intending to change its lane, and the vehicle on the right (code "47") was changing lanes to the left; and
4. the vehicle on the left (code "46") was changing lanes to the right, and the vehicle on the right (code "47") was changing lanes to the left.

In addition, when:

1. the right sides of the two vehicles impact following a 180 degree rotation of the vehicle on the right, or
2. the left sides of the two vehicles impact following a 180 degree rotation of the vehicle on the left.

Select the appropriate combination depending upon:

- their positions (i.e., left versus right) and
- the intended lane of travel (straight ahead versus changing lanes) of their drivers.

**44 Sideswipe/Angle: Straight Ahead on Left**

See discussion under Configuration: Sideswipe/Angle, above for an explanation of when this attribute applies.

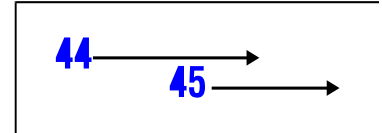

**45 Sideswipe/Angle: Straight Ahead on Left/Right**

See discussion under Configuration: Sideswipe/Angle, above for an explanation of when this attribute applies.

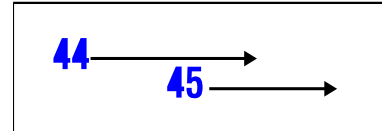

**46 Sideswipe/Angle: Changing Lanes to the Right**

See discussion under Configuration: Sideswipe/Angle, above for an explanation of when this attribute applies.

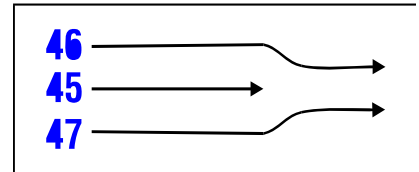

**47 Sideswipe/Angle: Changing Lanes to the Left**

See discussion under Configuration: Sideswipe/Angle, above for an explanation of when this attribute applies.

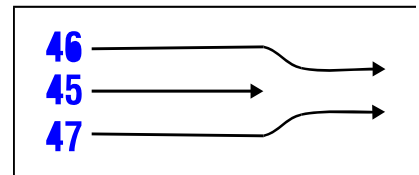

**48 Sideswipe/Angle: Specifics Other**

Enter "48" if one vehicle was behind the other prior to a sideswipe/angle collision occurring while both vehicles were traveling on the same trafficway and in the same direction.

**EACH: 48**  
**SPECIFICS**  
**OTHER**

For example, use this code when two vehicles are on the same trafficway and going the same direction, and one loses control and is struck in the side by the front of the other vehicle. However, if one vehicle rotates such that the impact is front to front, then use code "98" (Other crash type).

Use this code for crashes involving a driverless in-transport vehicle.

**49 Sideswipe/Angle: Specifics Unknown**

Enter "49" for sideswipe/angle collisions that occur while both vehicles are traveling on the same trafficway and in the same direction, when no further classification is possible.

**EACH: 49**  
**SPECIFICS**  
**UNKNOWN**

**Crash Category: Same Trafficway, Opposite Direction**

**Crash Configuration: Head-On**

The frontal area of one vehicle impacted the frontal area of another.

**50 Head-On: Lateral Move (Left/Right)**

Enter "50" for a vehicle that LEAVES ITS LANE [moves laterally (sideways)] immediately before colliding head-on with another vehicle, when the vehicles are traveling on the same trafficway in opposite directions.

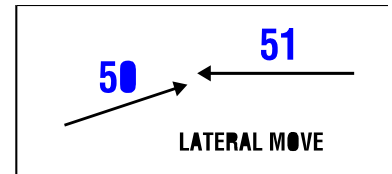

**51 Head-On: Lateral Move (Going Straight)**

Enter "51 " for a vehicle that collides head-on with another vehicle which has IMMEDIATELY LEFT ITS LANE (moved laterally), when the vehicles are traveling on the same trafficway in opposite directions.

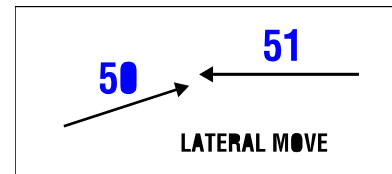

**52 Head-On: Specifics Other**

Enter "52" for a head-on collision that cannot be described by "50"- "51", when are traveling on the same trafficway in opposite directions. Clarification: Enter "52" for both vehicles involved in a head-on collision when one is traveling the wrong way on a one way roadway.

**EACH: 52**  
**SPECIFICS**  
**OTHER**

Enter "Specifics Other" for crashes involving a driverless in-transport vehicle.

**53 Head-On: Specifics Unknown**

Enter "53" when the PAR indicates a head-on collision occurred between two vehicles traveling on the same trafficway in opposite directions, when no further classification is possible.

**EACH: 53**  
**SPECIFICS**  
**OTHER**



**Crash Configuration: Forward Impact**

The frontal area of one vehicle impacted the frontal area of another following a steering maneuver around a noninvolved vehicle or an object.

**54 Forward Impact: Control/Traction Loss**

Enter "54" for a vehicle whose frontal area impacts another vehicle due to loss of control or traction (during a maneuver to avoid a collision with a third vehicle) while the vehicles are traveling on the same trafficway in opposite directions.

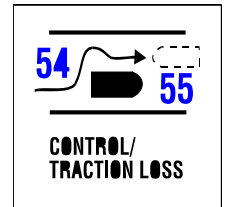

**55 Forward Impact: Control/Traction Loss**

Enter "55" for a vehicle which is impacted by the frontal area of another vehicle due to loss of control or traction (during a maneuver to avoid a collision with a third vehicle) while the vehicles are traveling on the same trafficway in opposite directions.

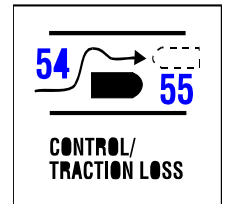

**56 Forward Impact: Control/Traction Loss**

Enter "56" for a vehicle whose frontal area impacts another vehicle due to loss of control or traction (during a maneuver to avoid a collision with an object) while the vehicles are traveling on the same trafficway in opposite directions.

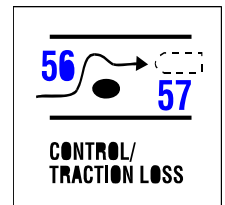

**57 Forward Impact: Control/Traction Loss**

Enter "57" for a vehicle which is impacted by the frontal area of another vehicle due to loss of control or traction (during a maneuver to avoid a collision with an object) while the vehicles are traveling on the same trafficway in opposite directions.

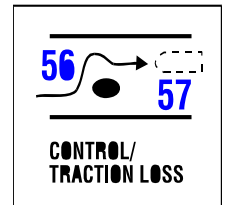

**58 Forward Impact: Avoid Collision with Vehicle**

Enter "58" for a vehicle whose frontal area impacts another vehicle while maneuvering to avoid a collision with a non-involved vehicle, when loss of control or traction was not a factor, and the vehicles were traveling on the same trafficway, in opposite directions.

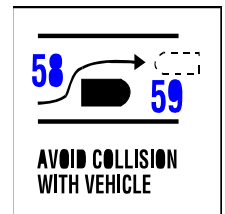

**59 Forward Impact: Avoid Collision with Vehicle**

Enter "59" for a vehicle which was impacted by the frontal area of another vehicle which was maneuvering to avoid collision with a non-involved vehicle when loss of control or traction was not a factor, and the vehicles were traveling on the same trafficway, in opposite directions.

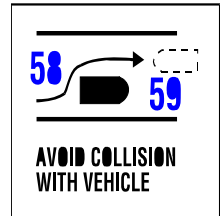

**60 Forward Impact: Avoid Collision with Object**

Enter "60" for a vehicle that struck the front of another vehicle with the frontal plane while maneuvering to avoid collision with an object, when loss of control or traction was not a factor, and the vehicles were traveling on the same trafficway, in opposite directions.

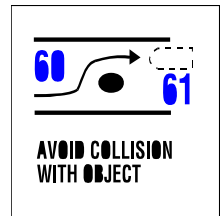

**61 Forward Impact: Avoid Collision with Object**

Enter "61" for a vehicle which was impacted by the frontal area of another vehicle which was maneuvering to avoid collision with an object, when loss of control or traction was not a factor, and the vehicles were traveling on the same trafficway, in opposite directions.

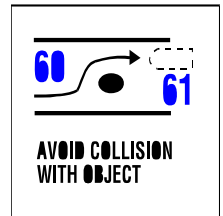

**62 Forward Impact: Specifics Other**

Enter "62" for forward impact collisions occurring while the vehicles were traveling on the same trafficway in opposite directions which cannot be described by "54"-"61". Enter "Specifics Other" for crashes involving a "driverless in-transport vehicle."



**63 Forward Impact: Specifics Unknown**

Enter "63" when the PAR indicates a forward impact collision occurred while the vehicles were traveling on the same trafficway in opposite directions, but no further classification is possible.



**Crash Configuration: Sideswipe/Angle**

The two vehicles are involved in an impact involving the side of one or both vehicles.

**64 Sideswipe/Angle: Lateral Move (Left/Right)**

Code "64" identifies the vehicle which infringed upon the other vehicle (code "65") in a Crash Category: Change Trafficway Opposite Direction, Crash Configuration: Sideswipe/Angle collision. Enter "64" for the vehicle which left its lane (moved laterally) leading to the collision.

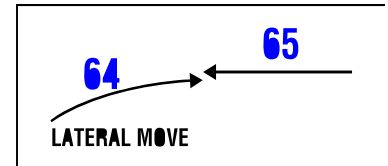

**65 Sideswipe/Angle: Lateral Move (Going Straight)**

Enter "65" for the vehicle which was infringed upon by the other vehicle (code "64") in a Crash Category: Change Trafficway Opposite Direction, Crash Configuration: Sideswipe/Angle collision.

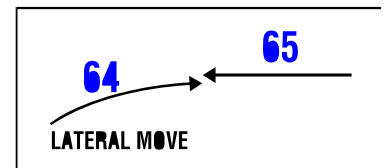

**66 Sideswipe/Angle: Specifics Other**

Enter "66" for sideswipe/angle collisions occurring while both vehicles were traveling on the same trafficway in opposite directions which cannot be described by "64"- "65". However, if one vehicle rotates such that the impact is front to front or front to rear, and did not result from a steering maneuver around a noninvolved vehicle or an object (category H) then use code "98" (Other crash type). Enter "Specifics Other" for crashes involving a driverless in-transport vehicle."



**67 Sideswipe/Angle: Specifics Unknown**

Enter "67" when the PAR indicates a sideswipe/angle collision occurred while both vehicles were traveling on the same trafficway in opposite directions, but no further classification is possible.



**Crash Category: Changing Trafficway, Vehicle Turning**

**Configuration J. Turn Across Path**

The two vehicles were initially on the same trafficway when one vehicle tried to turn onto another trafficway and pulled in front of the other vehicle. Vehicles making a "U" turn are identified in Category VI. Miscellaneous.

**68 Turn Across Path: Initial Opposite Directions (Left/Right)**

Code "68" identifies the vehicle which turned across the path of another vehicle (code "69") in a Category IV, Configuration J collision, in which the vehicles were initially traveling in opposite directions.

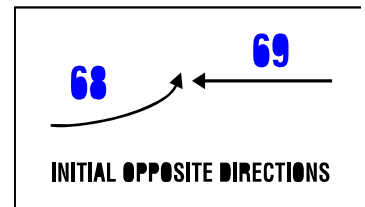

**69 Turn Across Path: Initial Opposite Directions (Going Straight)**

Enter "69" for a vehicle involved in a collision in which another vehicle (code "68") crossed its Path, and in which the vehicles were initially traveling in opposite directions.

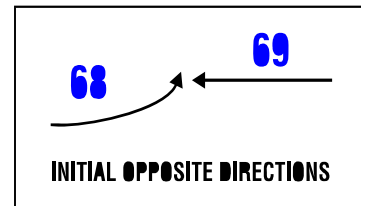

**70 Turn Across Path: Initial Same Directions (Turning Right)**

Enter "70" for a vehicle which turned right, across the path of another vehicle (code "71"), when both vehicles were initially traveling in the same direction.

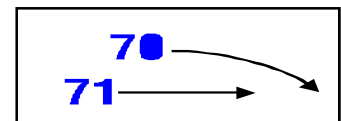

**71 Turn Across Path: Initial Same Directions (Going Straight)**

Enter "71 " for a vehicle whose path was crossed by a vehicle turning right (code "70"), when both vehicles were initially traveling in the same direction.

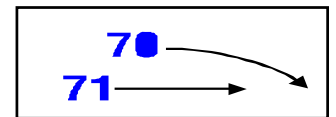

**72 Turn Across Path: Initial Same Directions (Turning Left)**

Enter "72" for a vehicle which turned left, across the path of another vehicle (code "73"), when both vehicles were initially traveling in the same direction.

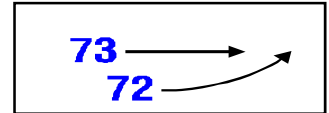

**73 Turn Across Path: Initial Same Directions (Going Straight)**

Enter "73" for a vehicle whose path was crossed by a vehicle turning left (code "72"), when both vehicles were initially traveling in the same direction.

**74 Turn Across Path: Specifics Other**

Enter "74" for collisions in which one vehicle turned across another's path, which cannot be described by "68"- "72". Enter "Specifics Other" for crashes involving a driverless in-transport vehicle.

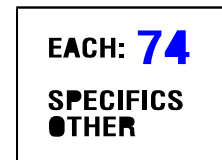

**75 Turn Across Path: Specifics Unknown**

Enter "75" when the PAR indicates one vehicle turned across another's path, causing a collision, but no further classification is possible.

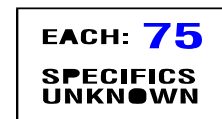

**Crash Configuration: Turn Into Path**

The two vehicles were initially on different trafficways when one attempted to turn into the same trafficway as the other vehicle.

Note, the focus of this configuration is on the turning maneuver from one trafficway to another and not on the vehicles' plane of contact.

**76 Turn Into Same Direction (Turning Left)**

Enter "76" for a vehicle which turned left, into the path of another vehicle (code "77"), so that both vehicles were traveling in the same direction at the time of the collision.

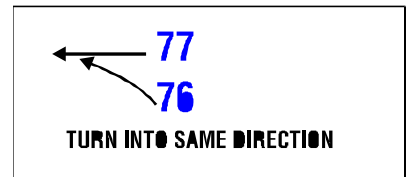

**77 Turn Into Same Direction (Going Straight)**

Enter "77" for a vehicle involved in a collision in which another vehicle (code "76") turned left, into its path, so that both vehicles were traveling in the same direction at the time of the collision.

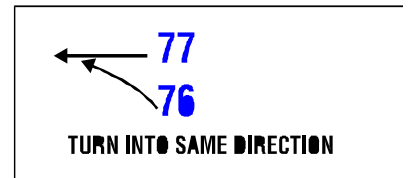

**78 Turn Into Same Direction (Turning Right)**

Enter "78" for a vehicle which turned right, into the path of another vehicle (code "79"), so that both vehicles were traveling in the same direction at the time of the collision.

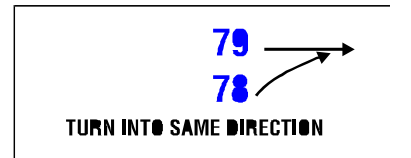

**79 Turn Into Same Direction (Going Straight)**

Enter "79" for a vehicle involved in a collision in which another vehicle (code "78") turned right, into its path, so that both vehicles were traveling in the same direction at the time of the collision.

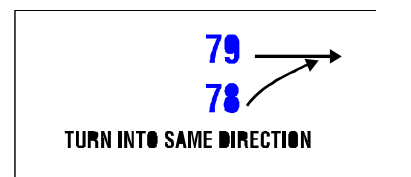

**80 Turn Into Opposite Directions (Turning Right)**

Enter "80" for a vehicle which turned right, into the path of another vehicle (code "81"), so that the vehicles were traveling in opposite directions at the time of the collision.

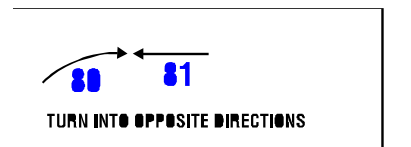

Crash Types (cont'd)

**81 Turn Into Opposite Directions (Going Straight)**

Enter "81" for a vehicle involved in a collision in which another vehicle (code "80") turned right, into its path, so that the vehicles were traveling in opposite directions at the time of the collision.

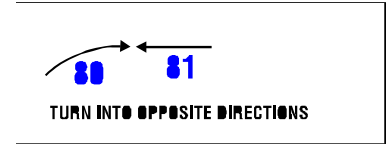

**82 Turn Into Opposite Directions (Turning Left)**

Enter "82" for a vehicle which turned left, into the path of another vehicle (code "83"), so that the vehicles were traveling in opposite directions at the time of the collision.

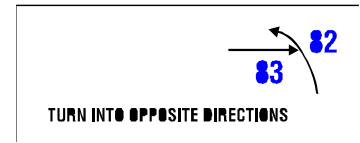

Code "82" is used when the driver's vehicle was in the act of making a left turn (e.g., from a driveway, parking lot or intersection). Do not confuse this situation with "**Crash Configuration: Straight Paths.**" The driver's intended path is the prime concern.

**83 Turn Into Opposite Directions (Going Straight)**

Enter "83" for a vehicle involved in a collision in which another vehicle (code "82") turned left, into its path, so that the vehicles were traveling in opposite directions at the time of the collision.

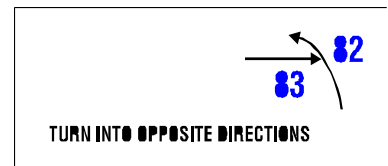

**84 Turn Into Path: Specifics Other**

Enter "84" for collisions in which one vehicle turned across another's path, which cannot be described by "76"-"83". Enter "Specifics Other" for crashes involving a driverless in-transport vehicle.



**85 Turn Into Path: Specifics Unknown**

Enter "85" when the PAR indicates one vehicle turned into another's path, causing a collision, but no further classification is possible.

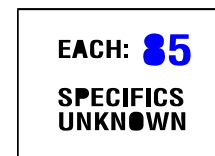

**Crash Category: Intersecting Paths (Vehicle Damage)**

Crash Configuration: Straight Paths

The two vehicles were proceeding (or attempting to proceed) straight ahead.

**86 Straight Paths: Striking from the Right**

Enter "86" for a vehicle which strikes the right side of another vehicle (code "87") from the right when both vehicles were going straight at the time of the collision, i.e., right side damage to 87, front damage to 86.

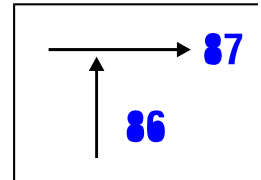

**87 Straight Paths: Struck on the Right**

Enter "87" for a vehicle which is struck on the right side by another vehicle (code "86") from the right when both vehicles were going straight at the time of the collision, i.e., right side damage to 87, front damage to 86.

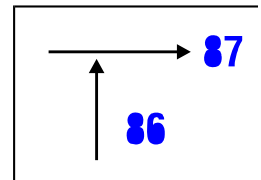

**88 Straight Paths: Striking from the Left**

Enter "88" for a vehicle which strikes another vehicle (code "89") from the left when both vehicles were going straight at the time of the collision, i.e., left side damage to 89, front damage to 88.

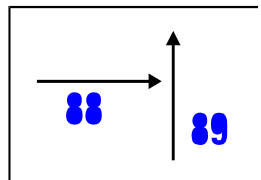

**89 Straight Paths: Struck on the Left**

Enter "89" for a vehicle which is struck on the left side by another vehicle (code "88") from the left when both vehicles were going straight at the time of the collision, i.e., left side damage to 89, front damage to 88.

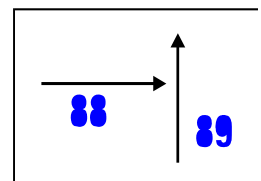

**90 Straight Paths: Specifics Other**

Enter "90" for collisions in which two vehicles, both going straight, collide when their paths intersect, which cannot be described by "86"- "89". Enter "Specifics Other" for crashes involving a driverless in-transport vehicle.

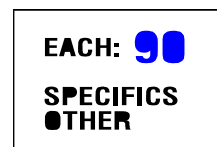



**91 Straight Paths: Specifics Unknown**

Enter "91 " when the PAR indicates two vehicles, both going straight, collided when their paths intersected, but no further classification is possible.

<p><b>EACH: 91</b></p> <p><b>SPECIFICS UNKNOWN</b></p>
--

**Crash Category: Miscellaneous**

**Crash Configuration: Backing, Etc.**

One of the two vehicles involved was a backing vehicle, regardless of its location on the trafficway or the damage location on the vehicles.

Any crash configuration which cannot be described in the above Crash Categories is included here.

**92 Backing, Etc.: Backing Vehicle**

Enter "92" for a backing vehicle which was involved with another vehicle (code 93) or object.

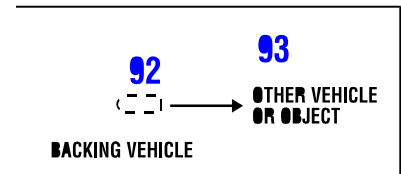

**93 Backing, Etc.: Other Vehicle or Object**

Enter "93" for the vehicle which was involved with the backing vehicle (code 92).

**98 Backing, Etc.: Other Crash Type**

Code "98" is used for those events and collisions which do not reasonably fit any of the specified types. This code includes (but is not limited to):

- Rollovers on the road
- U-turns
- Third or subsequent vehicles involved in a crash or
- The second involved vehicle, when the first harmful event involved a vehicle-to-object collision or a non-collision.

<b>98</b>	<b>OTHER ACCIDENT TYPE</b>
<b>99</b>	<b>UNKNOWN ACCIDENT TYPE</b>
<b>00</b>	<b>NO IMPACT</b>

**99 Backing, Etc.: Unknown Crash Type**

Code "99" when the crash category or configuration is unknown.

<b>98</b>	<b>OTHER ACCIDENT TYPE</b>
<b>99</b>	<b>UNKNOWN ACCIDENT TYPE</b>
<b>00</b>	<b>NO IMPACT</b>

**00 Backing, Etc.: No Impact**

Code "00" identifies non-collision events (fire, immersion, etc.)  
Rollovers on the road should be coded as Crash Type "98" **Other Accident Type**.

<b>98</b>	<b>OTHER ACCIDENT TYPE</b>
<b>99</b>	<b>UNKNOWN ACCIDENT TYPE</b>
<b>00</b>	<b>NO IMPACT</b>

DISTRACTIONS

General Vehicle Form, Case 2008-43-093B/ Vehicle #1

VEHICLE | SPECIFICATIONS | OFFICIAL RECORDS | PRECRASH | ROLLOVER | RECONSTRUCTION | DELTA V | LOG | REVIEW

ENVIRONMENT | MOVEMENT | DISTRACTIONS

Driver's Distraction/Inattention To Driving **Inattentive or distracted**

<input type="checkbox"/> By other occupant(s), (specify):	<input type="checkbox"/> Inattentive or lost in thought
<input type="checkbox"/> By moving object in vehicle (specify):	<input type="checkbox"/> Sleepy or fell asleep
<input type="checkbox"/> While talking/listening cell phone (specify loc/type phone):	<input type="checkbox"/> Distracted by outside person, object, or event (specify):
<input type="checkbox"/> While dialing cell phone (specify location/type phone):	<input type="checkbox"/> Eating or drinking (specify):
<input type="checkbox"/> While adjusting climate controls	<input type="checkbox"/> Smoking Related (specify):
<input type="checkbox"/> While adjusting radio, cassette, CD (specify):	<input type="checkbox"/> Other, distraction/inattention (specify):
<input type="checkbox"/> While using other device/controls integral to vehicle (specify)	<input type="checkbox"/> Unknown
<input type="checkbox"/> While using/reaching device/object brought into vehicle (specify)	

Save Close

**DRIVER'S DISTRACTION/INATTENTION TO DRIVING**

Page 1 of 2

**Screen Name:** Driver's Distraction/Inattention to Driving**SAS Data Set:** *GV***SAS Variable:** *DRATENTN***Oracle Name:** *VEHICLEPRECRASH.PICKDISTRACTION***Element Attributes:**

Oracle	SAS	
0	0	[No driver present]
2	1	Attentive or not distracted
3	2	Looked but did not see
4	3	Inattentive or distracted
18	9	Unknown

**Source:** Researcher determined — inputs include interviews and police report.**Remarks:****[No Driver Present]**

is pre-coded if on the Official Records Tab the "Driver Present?" variable is coded as "No driver Present".

**Attentive or not distracted**

is selected when the driver is known to have been completely attentive to driving prior to realization of impending danger.

**Looked but did not see**

is selected when the driver is paying attention to driving, but does not see the relevant vehicle, object, etc. This attribute should be used when a driver has an opportunity to take some action prior to impact, but the driver takes no action and no other distractions apply. This situation frequently occurs when an overtaking vehicle is in the driver's "blind spot" or at intersections when you look both ways and a crossing vehicle is not noticed. If the driver sees the vehicle, object, etc., but does not consider it a danger then, and no other distractions apply then select Attentive or not distracted

**Inattentive or distracted:**

is selected when the driver was inattentive or distracted prior to the realization of an impending critical event. Once this attribute is selected, options come into view where the Researcher can select all distractions that apply.

**Unknown**

is selected when it is unknown if this driver was fully attentive to driving prior to realization of impending danger. Use this attribute if no interview is obtained and there is no other source of information regarding this driver's attention to driving prior to realization of impending danger.

**DRIVER'S DISTRACTIONS**

**Screen Name:** Driver's Distraction/Inattention to Driving

**SAS Data Set:** ***DISTRACT***

**SAS Variable:** ***DRIVDIS***

**Oracle Name:** ***DRIVERDISTRACTION.DISTRACTIONID***

**Element Attributes:**

**Inattentive or distracted:**

Oracle	SAS	
1	1	By other occupant(s), (specify):
2	2	By moving object in vehicle (specify):
3	3	While talking/listening cell phone (specify loc and type phone):
4	4	While dialing cell phone (specify location/type of phone):
5	5	While adjusting climate controls
6	6	While adjusting radio, cassette, CD (specify):
7	7	While using other device/controls integral to vehicle (specify):
8	8	While using/reaching for device/object brought into vehicle (specify):
10	9	Sleepy or fell asleep
11	10	Distracted by outside person, object, or event (specify):
12	11	Eating or drinking (specify):
13	12	Smoking related (specify):
9	97	Inattentive or lost in thought
14	98	Other, distraction/inattention (specify):
-9999	99	Unknown

**Source:** Researcher determined — inputs include interviews and police report.

**Remarks:**

Select all the attributes which describe this driver's **inattention** to driving prior to the driver's realization of an impending critical event or just prior to impact if realization of an impending critical event does not occur. If this driver's vehicle has two critical crash envelopes, record the attribute(s) which best describe the driver's attention ***prior to the first Critical Precrash Event*** (*i.e.*, prior to realization of the impending danger which the driver successfully avoided). Intoxication is not considered a distraction.

All attributes which indicate “(specify)” require specific information to be annotated

**By other occupant(s) (specify):**

is selected when the driver was distracted by another occupant in this driver's vehicle prior to realization of impending danger. Examples of other occupant distraction include conversing with or looking at another occupant. The specific occupant distraction *must be recorded in the "specify box."*

**By moving object in vehicle (specify):**

is selected when the driver was distracted by a moving object in this driver's vehicle prior to realization of impending danger. Examples include a dropped object, a moving pet, insect or cargo. The specific object *must be recorded in the "specify box"*.

**While talking/listening cellular phone or reaching for a cell phone (specify loc/type of phone)**

is used when the driver is talking or listening on a cellular phone. Specify the type of phone (hands off, hand phone, etc.) and the location of the phone (installed in the console, held in the hand, etc.)

**While dialing cellular phone (specify location and type of phone)**

is used when the driver is dialing or text messaging (texting) on a cellular phone. This includes dialing or texting on any wireless e-mail device. Specify the type of phone used (hands free, handheld phone, etc.) and indicate where it is located (installed in the console, held in hand, etc.)

**While adjusting climate controls**

is selected when someone is distracted from the driving task while adjusting the air conditioner heater, etc.

**While adjusting radio, cassette, CD, (specify)**

is selected when someone is distracted from the driving task while adjusting or using the radio, cassette, CD which are mounted in the vehicle.

**While using other device/controls integral to vehicle, (specify)**

is selected when the driver is distracted while using a device in the vehicle including adjusting windows (power or manual) adjusting door locks (power or manual), adjusting side view mirrors (power or manual), adjusting rear view mirror, adjusting seat (power or manual), adjusting steering wheel, and adjusting seat belt, using vehicle's cigarette lighter, etc. (Included here is **all** OEM equipment).

**While using/reaching for device/object brought into vehicle (specify)**

is selected when the driver is distracted while using or reaching for a device brought into the vehicle including: radar detectors, CB radios, razors, portable CD players, headphones, etc. The use of another device to light a cigarette other than the vehicle's cigarette lighter should be coded under "smoking related". Specify the device in the provided space.

**Sleepy or fell asleep**

is selected when the driver was sleeping or dozing prior to realization of impending danger or just prior to impact if realization did not occur.

**Distracted by outside person, object, or event (Specify):**

is selected when the driver was distracted by an outside person, object or event prior to realization of impending danger. Examples include animals on the roadside or a previous crash. The specific outside person, object, or event must be recorded in the provided space. Do not use this attribute for a person, object or event which the driver has recognized and for which the driver has taken some action (e.g. avoiding a pedestrian on the roadway).

**Eating or drinking**

is used when the driver is eating or drinking, or involved in an activity related to these actions (*i.e.*, picking food from carton placed on passenger seat, reaching to throw out used food wrapper, etc.).

**Smoking related**

is selected when the driver is smoking or involved in an activity related to smoking, such as lighting cigarette, putting ashes in the ash tray, etc. The act of using the cigarette lighter of the vehicle, is selected as **While using other device/object integral vehicle**.

**Inattentive or lost in thought**

is selected when the driver is thinking about items other than the driving task (daydreaming).

**Other distraction (Specify)**

is selected when details regarding this driver's inattention are known but none of the specified attributes are applicable. The **Other Distraction** must be recorded in the provided space. This attribute includes incapacitating illness.

**Unknown**

is selected when it is known that this driver was inattentive prior to realization of impending danger but details of the distraction are unknown.



ROLLOVER

**General Vehicle Form, Case 2007-996-900015/ Vehicle #1**

VEHICLE | SPECIFICATIONS | OFFICIAL RECORDS | PRECRASH | DRIVER | ROLLOVER | RECONSTRUCTION | DELTA V | LOG | REVIEW

**Rollover Data**

Type: Longitudinal axis

Quarter Turns: 2

Interrupted Rollover: Yes

**Pre Rollover**

Maneuver: Departing roadway (to nonpaved surface)

**Rollover Initiation**

Type: Trip-over

Location: On shoulder -paved

Object Contacted Class: Collision with Fixed Object

Object Contacted: Tree(<= 10 cm in diameter)

**Rollover Specifics**

Location on Vehicle where Initial Principal Tripping Force Is Applied: Wheels/tires

Direction of Initial Roll: Roll right - primarily about the longitudinal axis

**Rollover Measurement**

Estimated distance: 10 mts

Save Close

Rollover Data Overview

The following variables provide a coded assessment of the occurrence of a rollover for this vehicle. A rollover is defined as any vehicle rotation of 90 degrees or more about any true longitudinal or lateral axis. A rollover may occur at any time during the crash sequence. When determining rollover presence, consider only the power unit, not any towed or trailing units. The variables also attempt to identify:

- What initiated the rollover
- At what plane of the vehicle exterior the tripping force was applied and
- The direction of the initial roll.

**ROLLOVER TYPE**

Page 1 of 2

**Screen Name:** Rollover Data-Type**SAS Data Set:** *GV***SAS Variable:** *ROLLTYPE***Oracle Name:** *VEHICLEROLLOVER.PICKROLLOVERTYPE***Element Attributes:**

Oracle	SAS	
1	0	No rollover (no overturning)
2	1	Rollover — Longitudinal axis
4	2	Rollover — end-over-end ( <i>i.e.</i> , primarily about the lateral axis)
	97	[Not a CDS Vehicle]
5	99	Overturn, details unknown

**Source:** Primary sources are the vehicle and scene inspections; secondary sources include photographs, police report, driver interviews, and other interviewees.

**Remarks:**

Rollover is defined as any vehicle rotation of 90 degrees or more about any true longitudinal or lateral axis. Rollover can occur at any time during the collision and is coded independently of other configuration questions.

**No rollover (no overturning)**

Select this code if uncertainty exists concerning whether or not this vehicle rolled over. In addition, use this attribute if a trailer attached to the vehicle rolled over but the vehicle itself did not.

**Longitudinal axis**

is selected when the vehicle rolls primarily from side-to-side (e.g., from left side, to top, to right side). If it is known that it rolled over the longitudinal axis, but the number of turns is unknown, then indicate **Longitudinal axis** and indicate **Unknown** on the next variable.

**Rollover — end-over-end (*i.e.*, primarily about the lateral axis)**

is selected when the rollover is mainly end-over-end. This attribute is used when a rollover is a combination of a side-to-side and end-over-end roll and it cannot be determined which type of rollover is most prevalent.

**NOTE:** Rollover Types indicated as Rollover – end-over-end (*i.e.*, primarily about the lateral axis) will automatically code all of the rollover variables to reflect an end-over-end rollover.

Rollover Type (cont'd)

Page 2 of 2

**Rollover (overturn), details unknown**

is selected when it is known that the vehicle rolled over, but the rollover details cannot be determined. If it is known that it rolled over the longitudinal axis, but the number of turns is unknown, then indicate **Longitudinal axis** and indicate **Unknown** on then next variable.

NUMBER OF QUARTER TURNS

Screen Name: Rollover Data-Quarter Turns

SAS Data Set: GV

SAS Variable: ROLLOVER

Oracle Name: VEHICLEROLLOVER.ROLLOVERTURNS

Element Attributes:

Oracle SAS

		Enter the number of quarter turns:
-8866	0	No rollover
-8865		[End over end]
	88	[Not a CDS Vehicle]
-9999	99	Unknown

Range 1-20, Unknown  
20 includes, 21 or more quarter rolls

Source: Primary sources are the vehicle and scene inspections; secondary sources include photographs, police report, driver interviews, and other interviewees.

Remarks:

Enter the number of quarter turns

based on the researcher's crash reconstruction. A "quarter turn" is defined as a rotation of 90 degrees about the longitudinal axis of the vehicle; this does not include rotation about the vertical axis, commonly called yaw. Therefore, if a vehicle rolled about the longitudinal axis onto its roof (i.e., side- to-side roll), then it rolled 180 degrees and entered as "2" quarter turns.

In the example below, the vehicle rolled from its upright position to left side, to top, then to the right side, and back onto its wheels. This would be indicated as "4" quarter turns.

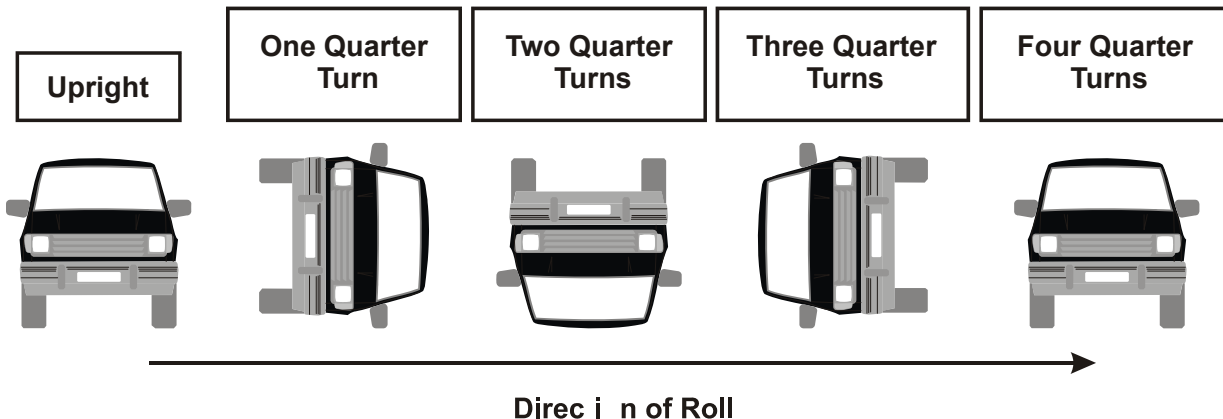

Number of Quarter Turns (cont'd)

Page 2 of 2

**Unknown**

is selected when it cannot be determined the number of quarter turns the vehicle did during the rollover sequence.

**INTERRUPTED ROLL**

**Screen Name:** Interrupted roll

**SAS Data Set:**

**SAS Variable:**

**Oracle Name:** *VEHICLEROLLOVER.INTERRUPTED*

**Element Attributes:**

Oracle	SAS	
1	1	Yes
2	2	No
9	99	Unknown
8	88	[No rollover] [Not a CDS vehicle] [End over End]

**Source:** Vehicle inspection, scene inspection, interviews, and police report.

**Remarks:**

The purpose of this variable is to determine if the vehicle's rollover sequence was acted upon by another vehicle or object between the trip point and the final rest position. Examples may include the vehicle striking a tree with its top during the rollover sequence, or contacting an object in the environment. This impact should have an effect on the distance the vehicle would have traveled from trip point to final rest.

**Note:**

If the researcher determines that the rollover sequence was interrupted, an event and CDC must be assigned to the vehicle damage from the object which interrupted the roll.

**Yes**

is selected when the rollover sequence was interrupted.

**No**

is selected when the rollover sequence was not interrupted.

**Unknown**

is selected when it is unknown if the rollover sequence was interrupted.

**PRE ROLLOVER MANUEVER**

Screen Name: Maneuver

*SAS Data Set:*

*SAS Variable:*

*Oracle Name: VEHICLEROLLOVER.PREMANEUVER*

**Element Attributes:**

Oracle	SAS	
1	1	No rollover
2	2	Departing roadway (to paved surface)
3	3	Departed roadway (to non-paved surface)
4	4	Returning to roadway (from paved surface)
5	5	Returning to roadway (from non-paved surface)
6	6	On roadway maneuver
7	7	Off roadway maneuver
-9999	99	Unknown [Not a CDS vehicle]

**Source:** Researcher determined — primary sources are the scene and vehicle inspections. Secondary sources are photographs, police report, driver interviews, and other interviewees.

**Remarks:**

Determine the last controlled maneuver, relative to the roadway, prior to the initiation of the rollover.

**No rollover**

No rollover occurred involving this vehicle.

**Departing roadway (to paved surface)**

Vehicle departs roadway to a paved shoulder, gore or other area as the last movement prior to the tripping point. This area is usually delineated by painted lines or ceramic dots.

**Departing roadway (to non-paved surface)**

Vehicle departs roadway to an unpaved shoulder or unimproved area as the last movement prior to the trip point.

**Returning to roadway (from paved surface)**

Vehicle returns to the roadway from a paved shoulder or other area as the last movement prior to the trip point. Painted lines or ceramic dots usually delineate this area.

Pre-rollover maneuver (cont'd)

Page 2 of 2

**Returning to roadway (from non-paved surface**

Vehicle returns to the roadway from an unpaved shoulder or other area as the last movement prior to the trip point.

**On Roadway maneuver**

The vehicle remained predominantly on the roadway and the trip point is on the roadway or immediately next to it.

**Off Roadway maneuver**

The vehicle departed the roadway completely. While off the roadway the vehicle began or completed a maneuver different than the one that took it off the roadway.

**Unknown**

The researcher is unable to determine the maneuvers or location of the vehicle just prior to the rollover initiation. This code should be used only in very rare instances.



## ROLLOVER INITIATION TYPE

Page 1 of 5

Screen Name: Rollover Initiation-Type

SAS Data Set: *GV*SAS Variable: *ROLINTYP*Oracle Name: *VEHICLEROLLOVER.PICKROLLOVERINITTYPE*

## Element Attributes:

Oracle	SAS	
-8888	0	[No rollover (no overturning)]
1	1	Trip-over
2	2	Flip-over
3	3	Turn-over (specify)
4	4	Climb-over
5	5	Fall-over
6	6	Bounce-over
7	7	Collision with another vehicle
8	8	Other rollover initiation type (specify)
	88	[Not a CDS Vehicle]
10	98	[End-over-end]
9	99	Unknown

**Source:** Researcher determined — primary sources are the scene and vehicle inspections. Secondary sources are photographs, police report, driver interviews, and other interviewees.

**Remarks:**

Various types of rollovers are identified above. A vehicle action that cannot be categorized under any of the above elements should be coded **Other rollover initiation type** and specified in the space provided. The attributes below are used for rollovers initiated about the longitudinal axis. Rollover Types indicated as Rollover – end-over-end (i.e., primarily about the lateral axis) will automatically code all of the rollover variables to reflect an end-over-end rollover.

**Trip-over**

is selected when the vehicle's lateral motion is suddenly slowed or stopped, inducing a rollover. The opposing force may be produced by a curb, pot-holes, or pavement/soil dug into by a vehicle's wheels.

**Trip-Over:**  
The vehicle's lateral motion is resisted by opposing force, inducing roll moment.

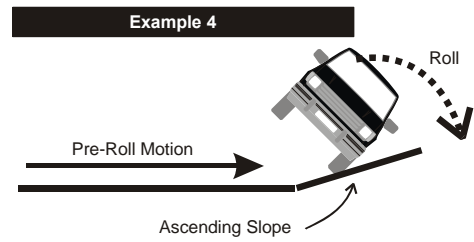
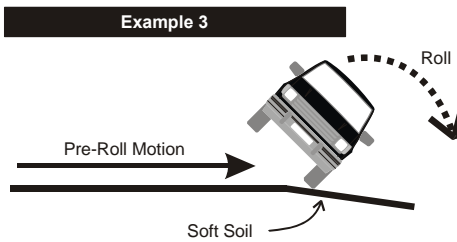
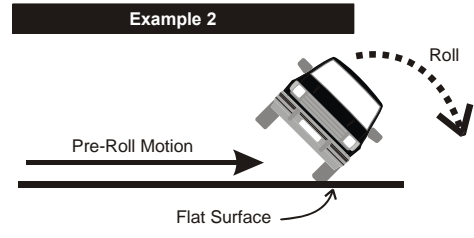
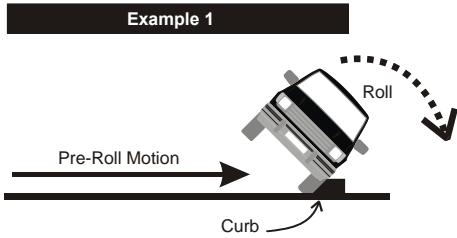

**Flip-Over**  
is selected when the vehicle is rotated about its longitudinal axis by a ramp-like object may be in a yaw when it comes in contact with the ramp-like object. For example, if the vehicle traveling forward climbs the down turned end of a guardrail and rolls over about

**Flip-Over**

Forward moving vehicle is vigorously rotated about its longitudinal axis by a ramp-like object such as a guardrail taper or ditch back slope.

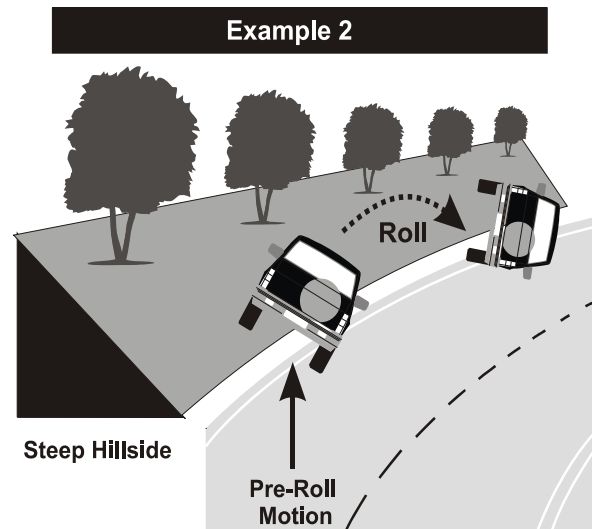
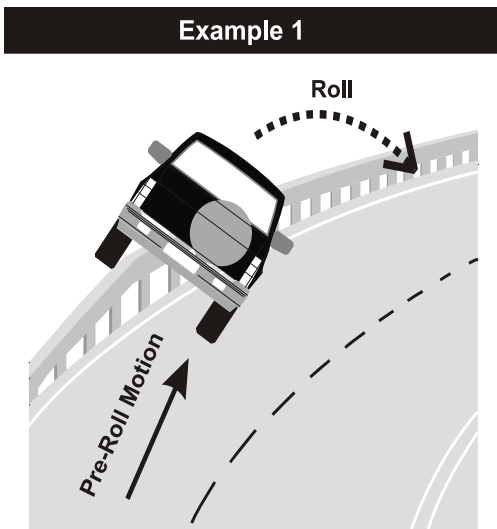

its longitudinal axis, use this code. To use this, the vehicle's roll need not begin on the ramp-like structure or object, For example, if the vehicle transverses the turned-down end of a guardrail, continues along the level portion, then rolls back toward the side of the guardrail from which it came, use this code.

**Turn-Over**

is selected when centrifugal forces from a sharply turning or rotating vehicle produce a rollover when resisted by normal surface friction. This type of rollover is more likely to occur in vehicles with a higher center of gravity than most passenger vehicles. The surface type includes pavement surfaces plus gravel, grass, dirt, etc. The distinction between **Turn-over** and **Trip-over** is that no furrowing, gouging, etc. occurs to the surface at the point of trip. In addition, see remarks for **Fall-over** below. When turnover is selected, the justification **must be entered**.

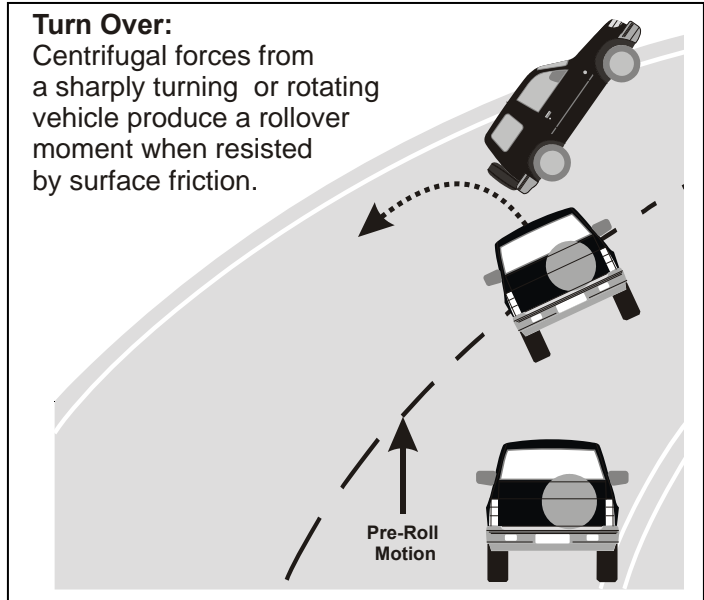

**Climb-Over**

is selected when a vehicle climbs up and over a fixed object such as a barrier or guardrail. The object should be high enough to lift the vehicle completely off the ground (*i.e.*, the height should exceed the radius of the vehicle's largest diameter wheel). The vehicle must roll to the opposite side from which it approached the object.

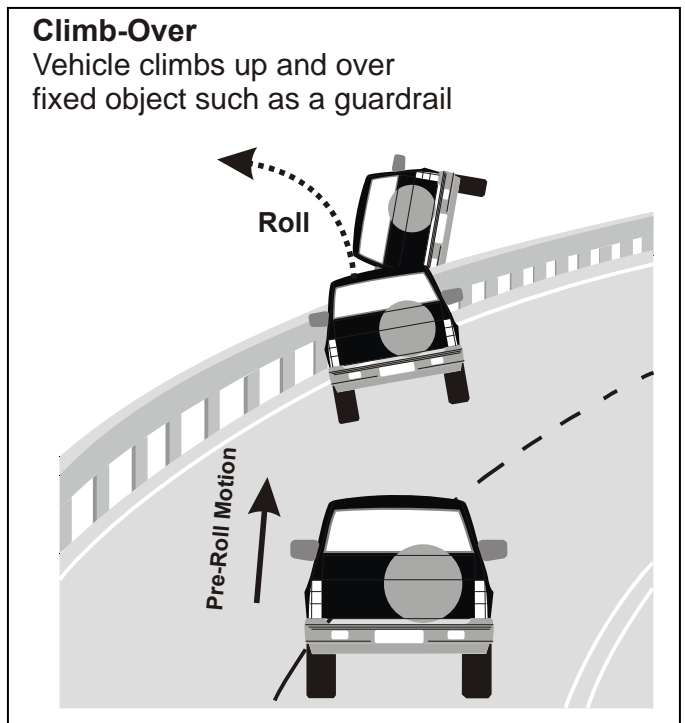

**Fall-Over**

is selected when the surface the vehicle is traversing slopes downward in the direction of movement of the vehicle's center-of-gravity such that the vehicle's center of gravity becomes outboard of its wheels. The distinction between this and **Turn-over** above involves the negative slope of the traversed surface. If the rotation and/or the surface friction causes the trip, then use **Turn-over**, however, if the slope is so negative that

a line straight downward through the vehicle's center-of-gravity (as shown in the illustration) would fall outside the vehicle's track, then use this attribute. For example, if a vehicle goes off the road and encounters a substantial surface drop off because of the elevated nature of the road in relation to its environment (*e.g.*, cliff, ditch, etc.), then use this attribute.

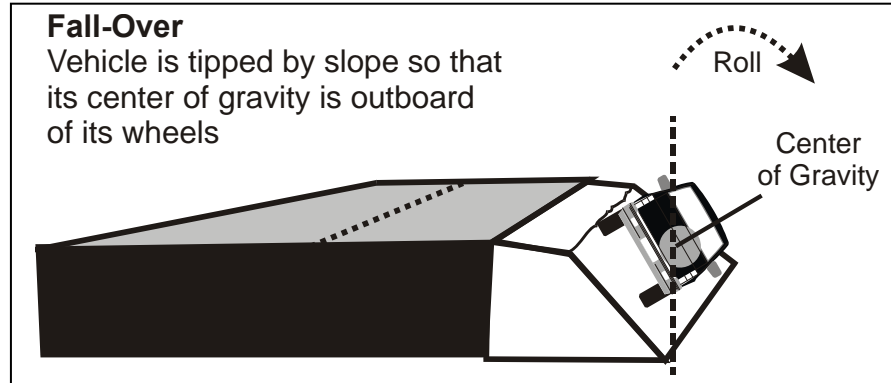
**Bounce-Over**

is selected when a vehicle deflects off of a fixed object (such as a guardrail, barrier, tree, or pole) or a not-in-transport vehicle such that the vehicle's rotation causes it to overturn. The deflection momentum contributes to a rollover. To use this attribute, the rollover must occur in close proximity to the object from which it deflected. For example, if a vehicle strikes a center median barrier and rotates across two traffic lanes prior to the vehicle rolling over, then **Trip-over** or **Turn-over** would apply.

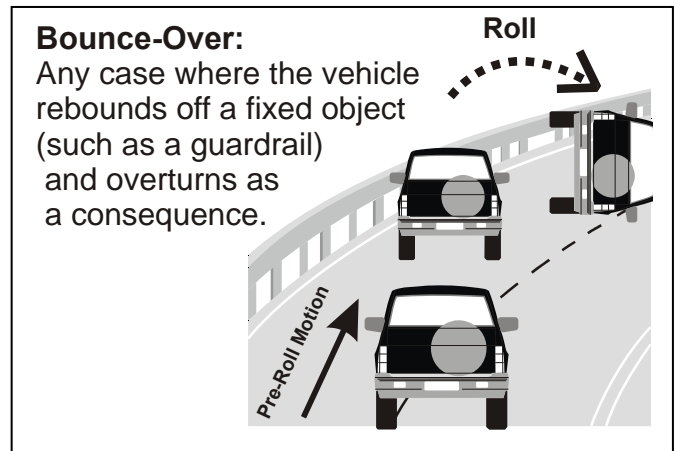
**Collision with another vehicle**

is selected when an impact with another vehicle causes the rollover. The rollover must be the immediate result of the impact between the vehicles (*e.g.*, intersection crashes where a vehicle is struck in the side and the momentum of the struck vehicle results in the rollover, or offset end-to-end type crashes when one vehicle will vault over the tapered end of another vehicle resulting in a rollover). Otherwise use attributes above. For example, if a vehicle is struck in the side **and** the vehicle rotates **and** does not produce any wheel/rim gouges or furrows in the surface nor encounters any prominent raised objects (*e.g.*, a high curb) **and** overturns in close proximity to the point of impact, then use this attribute.

Rollover Initiation Type (cont'd)

Page 5 of 5

**Other rollover initiation type**

is selected when this vehicle's rollover initiation type cannot be described above. Whenever this is used, the researcher is required to *specify* the type of rollover which occurred.

**Unknown**

is selected when the type of rollover initiation is unknown

**[End-over-end]**

is automatically entered when the type of rollover is end-over-end.

## LOCATION OF ROLLOVER INITIATION

Page 1 of 2

Screen Name: Rollover Initiation-Location

SAS Data Set: *GV*SAS Variable: *ROLINLOC*Oracle Name: *VEHICLEROLLOVER.PICKLOCATIONROLLOVERINIT*

## Element Attributes:

Oracle	SAS	
-8888	0	[No rollover (no overturning)]
1	1	On roadway
2	2	On shoulder — paved
3	3	On shoulder — unpaved
4	4	On roadside or divided trafficway median
	7	[Not a CDS Vehicle]
6	8	[End-over-end]
5	9	Unknown

**Source:** Researcher determined — primary source is the scene inspection. Secondary sources are vehicle inspection, photographs, police report, driver interviews, and other interviewees.

**Remarks:**

This variable defines the location of the trip point or start of the vehicle's roll that was identified in, Rollover Initiation Type. Physical evidence on and/or off the roadway should be used to identify the point of initial roll. Scenes with no physical evidence such as gouges in the pavement or ground may be determined by the secondary sources listed above.

**On roadway**

is selected when the rollover initiates in the travel lanes of the roadway (*i.e.*, between painted edgelines or between roadway edges when painted edgelines are absent). The median between roadways (divided highways such as thruways or expressways) is identified as codes On shoulder—paved, On shoulder—unpaved, or On roadside or divided trafficway median as described below. ANSI defines a **roadway** as that part of a trafficway designed, improved and ordinarily used for motor vehicle travel, and excludes any shoulder alongside the roadway.

**On shoulder — paved**

is selected when the rollover initiation occurs on a paved surface outside the painted edgeline or the outer edge or pavement seam of the roadway. A shoulder may exist within the median of a divided highway or on the outermost edge of the roadway. A shoulder is defined as that part of a trafficway

contiguous with the roadway for emergency use, for accommodation of stopped road vehicles, and for lateral support of the roadway structure.

**On shoulder — unpaved**

is selected when the rollover initiation begins within the confines of the *improved* area (*i.e.*, gravel or stone) contiguous with the roadway. Unpaved shoulders, for NASS CDS purposes, are composed of loose gravel or stone. Combination gravel/stone and asphalt surfaces, such as macadam or "chip and seal", are considered as paved. Roadways without an improved, contiguous surface will be considered as not having shoulders.

**On roadside or divided trafficway median**

is selected when the rollover initiation occurs outside the roadway and the shoulder. There are roads where sod or dirt will support the roadway edge. When the rollover initiation occurs within this area, use this attribute because this roadway does not have shoulders. In addition, shoulders end wherever most curbs or fixed objects begin. If the trip begins on a curb that is adjacent on one side to a sidewalk, turf, or dirt, then use this attribute. If the roll is initiated by a fixed object then use this attribute. Care must be exercised with some mountable curbs. If the mountable curb has paving on both sides and its primary function is to control water runoff, then use **On shoulder—paved**.

**ROLLOVER INITIATION OBJECT CONTACTED CLASS**

**Screen Name:** Rollover Initiation--Object Contacted Class

**SAS Data Set:** N/A

**SAS Variable:** N/A

**Oracle Name:** *VEHICLEROLLOVER.ROLLINITOBJCLASS*

**Element Attributes:**

Oracle	SAS
1	Vehicle
2	Non-collision
3	Collision with Fixed Object
5	Collision with Nonfixed Object
7	Other event (specify)
6	Unknown Event or Object

**Source:** Researcher determined — primary source is the scene inspection. Secondary sources are vehicle inspection, photographs, police report, driver interviews, and other interviewees.

**Remarks:**

The Object Contacted codes in the next variable are grouped into specific classes. The class is first selected, then the object lists are filtered for items in that specific class.

**Vehicle**

is selected when the object contacted that caused this vehicle to rollover is another vehicle.

**Noncollision**

is automatically entered by the program when a “Turn Over” or “Fall Over” is selected as the rollover initiation type, or when the rollover was initiated by a jackknife noncollision. Additionally this code is used for end-over-end rollovers.

**Collision with a Fixed Object**

is selected when an impact with a fixed object (e.g., a tree, breakaway pole or post, embankment, curb, etc.) caused the rollover.

**Nonbreakaway Pole or Post**

is selected when the object contacted that caused the vehicle to rollover was a nonbreakaway pole or post.



**Collision with a Non-Fixed Object**

is selected when the collision that initiated the rollover is a non-fixed object (e.g., motor vehicle not in transport, animal, railway vehicle, trailer disconnected in transport, etc.).

## ROLLOVER INITIATION OBJECT CONTACTED

Page 1 of 8

Screen Name: Rollover Initiation--Object Contacted

SAS Data Set: GV

SAS Variable: ROLLOBJ

Oracle Name: VEHICLEROLLOVER.ROLLINITOBJTYPE

## Element Attributes:

Oracle	SAS	
-8866	0	[No rollover (no overturning)]

Vehicle number (1-30)

## Non-collision

31	31	Turn-over — fall-over
32	32	No rollover impact initiation (end-over-end)
34	34	Jackknife

## Collision With Fixed Object

41	41	Tree (<=10 centimeters in diameter)
42	42	Tree (> 10 centimeters in diameter)
43	43	Shrubbery or bush
44	44	Embankment
45	45	Breakaway pole or post (any diameter)
100	47	Cable barrier guardrail
101	46	Metal guardrail
48	48	Guardrail Face
49	49	Guardrail End

## Nonbreakaway Pole or Post

50	50	Pole or post (<=10 centimeters in diameter)
51	51	Pole or post (> 10 centimeters but <= 30 centimeters diameter)
52	52	Pole or post (> 30 centimeters in diameter)
53	53	Pole or post (diameter unknown)
54	54	Concrete traffic barrier
55	55	Impact attenuator
56	56	Other traffic barrier (specify)
57	57	Fence

**Nonbreakaway Pole or Post cont'd**

Oracle	SAS	
58	58	Wall
59	59	Building
60	60	Ditch or culvert
61	61	Ground
62	62	Fire hydrant
63	63	Curb
64	64	Bridge
68	68	Other fixed object (specify):
69	69	Unknown fixed object

**Collision with Nonfixed Object**

76	76	Animal
102	77	Railway vehicle
78	78	Trailer, disconnected in transport
79	79	Object fell from vehicle in-transport
88	88	Other nonfixed object (specify):
89	89	Unknown nonfixed object

**Other Event**

98	98	Other event (specify)
----	----	-----------------------

**Unknown Event or Object**

99	99	Unknown event or object
97	97	[Not a CDS Vehicle]

**Source:** Researcher determined — primary sources are the scene and vehicle inspections; secondary sources include the police report and interviewees.

**Remarks:**

This variable is related to Rollover Initiation Type, and identifies the source of the force that acted upon the vehicle which resulted in the rollover. These attributes are obtained from the Exterior Vehicle Form, CDC tab, Object Contacted attributes. If the rollover was initiated by an impact which was assigned a CDC, then the applicable element value will be selected for this variable. If the rollover was not initiated by a CDC applicable impact, then it is unlikely that the same value will be selected. Therefore, the researcher must determine the cause (*i.e.*, initiation force) of the rollover and consequently the object contacted during the rollover. For example, if a vehicle strikes

a curb which trips the vehicle, then select **Curb** even though the CDC Object Contacted for the rollover would probably equal **Overturn- rollover**.

Similarly, if a vehicle vaults a longitudinal barrier (Climb-over), then select **Concrete traffic barrier** or **Other traffic barrier**, depending upon the longitudinal barrier design. If a yawing vehicle rolls as a result of centrifugal forces caused by normal surface friction or as a result of burrowing into soft soil, then select **Ground** because the ground applied the force that acted as the tripping mechanism for the rollover.

**Vehicle number**

select the vehicle number to report the vehicle that impacted this vehicle and caused the rollover to occur [*i.e.*, Rollover initiation type must equal Collision with another vehicle]. Select the vehicle

number of the vehicle that initiated the rollover to this vehicle. This will be most common when one vehicle (generally with a high center of gravity) is involved in an offset head-on crash with a second vehicle (possibly with a lower sloping front end) resulting in a vaulting type rollover. Do not use these attributes if the vehicle rolls over subsequent to its impact with another vehicle but because of centrifugal force or a tripping mechanism. These latter two causes would take priority.

**Turn-over — fall-over**

excludes end-over-end and is used when the vehicle roll is precipitated by centrifugal or gravitational forces and Rollover Initiation Type, has been selected **Turn-over** or **Fall-over**.

**Jackknife**

is selected when a vehicle rolls over as result of a jackknife and the sole reason for the rollover is the force applied by the jackknifing trailer. For example, if a vehicle is pulling a trailer and the trailer jackknifes (*i.e.*, 90 degrees rotation and intraunit damage) and overturns, for whatever reason (*e.g.*, trailer tires furrow in soft earth, centrifugal force, trailer trips, loadshifts causing it to tip, etc.), **and** the trailer's overturning causes this vehicle to overturn, then use this. However, if a centrifugal force or tripping mechanism causes the vehicle to overturn with or without the trailer overturning, then use another attribute.

**Tree (< 10 centimeters in diameter)**

is selected when a vehicle impacts a tree which has a diameter of ten centimeters or less and the tree either (1) acts like a rigid barrier or (2) bends or breaks causing the vehicle to rollover [*i.e.*, Rollover Initiation Type equals Trip-over, Flip-over, or Bounce-over]. Select another attribute when a vehicle impacts a tree and experiences a subsequent rollover due to centrifugal forces or other tripping mechanisms.

**Tree (> 10 centimeters in diameter)**

is selected when a vehicle impacts a tree with a diameter of greater than 10 centimeters and the tree either (1) acts like a rigid barrier or (2) bends or breaks causing the vehicle to rollover [*i.e.*, Rollover Initiation Type equals Trip-over, Flip-over, or Bounce-over]. Select another attribute when a vehicle impacts a tree and experiences a subsequent rollover due to centrifugal forces or other tripping mechanisms.

**Shrubbery or bush**

is selected when a vehicle impacts shrubbery or bushes and the contacted object causes the vehicle to rollover [*i.e.*, Rollover Initiation Type equals Trip-over or Flip-over]. This will be a very rare occurrence. Subsequent rollovers that result from centrifugal forces or other tripping mechanisms take priority for this variable.

**Embankment**

is selected when a vehicle rides up or over an embankment and the vehicle rolls over as a result of the angle of the embankment [*i.e.*, Rollover Initiation Type equals Flip-over or Fall-over]. Vehicles which dig into the surface of an embankment and rollover as a result of this tripping mechanism are captured in **Ground**.

**Breakaway pole or post (any diameter)**

is selected whenever a vehicle impacts a breakaway pole or post (of any diameter) and that pole/post yields creating a ramping mechanism which causes a vehicle rollover. Select another attribute if a vehicle rolls over subsequent to the impact as a result of centrifugal forces or other tripping mechanisms.

**Pole or post (• 10 centimeters in diameter)**

is selected whenever a vehicle impacts a nonbreakaway pole with a diameter of 10 centimeters or less and that pole either (1) acts like a rigid barrier or (2) breaks or bends causing the vehicle to rollover [*i.e.*, Rollover Initiation Type equals Flip-over or Bounce-over]. Do not use this attribute if a vehicle rolls over subsequent to the impact as a result of centrifugal forces or other tripping mechanisms.

**Pole or post (> 10 centimeters but • 30 centimeters in diameter)**

is selected whenever a vehicle impacts a nonbreakaway pole with a diameter greater than ten centimeters but less than or equal to thirty centimeters and that pole either (1) acts like a rigid barrier or (2) breaks or bends causing the vehicle to rollover [*i.e.*, 6 equals Flip-over or Bounce-over]. Select another attribute if a vehicle rolls over subsequent to the impact as a result of centrifugal forces or other tripping mechanisms.

**Pole or post (> 30 centimeters in diameter)**

is selected whenever a vehicle impacts a nonbreakaway pole with a diameter greater than thirty centimeters and that pole either (1) acts like a rigid barrier or (2) breaks or bends causing the vehicle to rollover [*i.e.*, Rollover Initiation Type equals Flip-over or Bounce-over]. Select another attribute if a vehicle rolls over subsequent to the impact as a result of centrifugal forces or other tripping mechanisms.

**Pole or post (diameter unknown)**

is selected whenever a vehicle impacts a pole or post of an unknown diameter and that pole either (1) acts like a rigid barrier or (2) breaks or bends causing the vehicle to rollover [*i.e.*, Rollover Initiation Type equals Flip-over or Bounce-over)]. Do not use this attribute if a vehicle rolls over subsequent to the impact as a result of centrifugal forces or other tripping mechanisms.

**Concrete traffic barrier**

is selected whenever a vehicle impacts a concrete traffic barrier and that impact causes a rollover [*i.e.*, Rollover Initiation Type equals Flip-over, Climb-over, or Bounce-over]. Rollovers which occur subsequent to the impact as a result of centrifugal force or other tripping mechanisms are not considered here. Refer to variable Objected Contacted for examples and definitions of concrete traffic barriers.

**Impact Attenuator**

is selected whenever a vehicle impacts a crash cushion (refer to variable Objected Contacted) and that impact causes a rollover [*i.e.*, Rollover Initiation Type equals Flip-over or Bounce-over]. Rollovers which occur subsequent to the impact as a result of centrifugal force or other tripping mechanisms are not considered here.

**Other traffic barrier**

is selected whenever a vehicle impacts a non-concrete longitudinal barrier as defined in variable Objected Contacted and that impact causes a rollover [*i.e.*, Rollover Initiation Type equals Flip-over, Climb-over, or Bounce-over]. Rollovers which occur subsequent to the impact as a result of centrifugal force or other tripping mechanisms are not considered here.

**Cable barrier guardrail**

refers to a guardrail consisting of 2 to 4 wire cables supported by cable mounts that are attached to steel posts.

**Guardrail Face**

refers to a cold formed standard W Section or thrie-beam of steel rigid beam elements bolted to posts usually with offset blocks.

**Guardrail End**

refers to the end of a guardrail. Guardrails can have a separate flat or rounded piece of metal attached to the end of an expanse of guardrail face.

**Fence, Wall, and Building**

are selected whenever one of these objects is contacted and that impact causes a rollover [*i.e.*, Rollover Initiation Type equals Trip-over, Flip-over, Climb-over, or Bounce-over]. Definitions of these objects are defined in variable Object Contacted. Rollovers which occur subsequent to the impact as a result of centrifugal impacts and tripping mechanisms are not considered for these attributes.

**Ditch or Culvert**

is selected whenever a vehicle enters a ditch or culvert and the vehicle rolls over as a result of the slope of the ditch/culvert [*i.e.*, Rollover Initiation Type equals Flip-over or Fall-over]. Refer to variable Objected Contacted for definition of ditch or culvert. Vehicles in a ditch which dig into the surface and rollover as a result of this tripping mechanism are captured in **Ground**.

**Ground**

is selected when a vehicle rolls over as a result of contact with the ground [*i.e.*, Rollover Initiation Type equals Trip-over]. "Ground" applies whether the rollover resulted from digging into soft soil, tripping over an accumulation of dirt or gravel, or gouging into the pavement. Vehicles which dig into the ground on embankments or in ditches and rollover, as a result of that digging, take this attribute.

**Fire Hydrant**

is selected whenever a vehicle impacts a fire hydrant and that impact causes a rollover. A fire hydrant is defined as a roadside device used by fire departments to provide water for fighting fires. Vehicles which rollover subsequent to a fire hydrant impact but not as a direct result of that impact (*i.e.*, other tripping force) do not take this attribute.

**Curb**

includes both mountable and barrier curbs as described for variable Objected Contacted. Curbs which act as a tripping mechanism will frequently have an impact (CDC) associated with them although this is not a criterion for using this attribute. When a curb acts as a tripping mechanism, Rollover Initiation Type is coded Trip over.

**Bridge**

is selected whenever a vehicle impacts a bridge and that impact causes a rollover [*i.e.*, Rollover Initiation Type equals Flip-over, Climb-over, or Bounce-over]. Refer to variable Objected Contacted for the definition of a bridge. Vehicles which rollover subsequent to a bridge impact but not as a direct result of that impact (*i.e.*, other tripping force) do not take this attribute.

**Other fixed object**

is selected when a fixed object, other than those previously identified impacted and that impact causes a rollover. Do not use this attribute if a vehicle rolls over subsequent to the impact as a result of centrifugal forces or other tripping mechanisms.

**Unknown fixed object**

is selected when an unknown fixed object is impacted and that impact causes a rollover. Do not use this attribute if a vehicle rolls over subsequent to the impact as a result of centrifugal forces or other tripping mechanisms.



**Passenger car, light truck, van, or other vehicle not in-transport**

is selected when a vehicle impacts a not-in-transport passenger car, light truck, van, or any other motor vehicle that is not a medium/heavy truck or bus and that impact causes the vehicle to rollover [*i.e.*, Rollover Initiation Type equals Flip-over, Climb-over, or Bounce-over]. Vehicles which rotate and rollover as a result of centrifugal forces or other tripping mechanisms are not captured in this response.

**Medium/heavy truck or bus not in-transport**

is selected when a vehicle impacts a not-in-transport medium/heavy truck or bus and that impact causes the vehicle to rollover [*i.e.*, Rollover Initiation Type equals Flip-over, Climb-over, or Bounce-over]. Vehicles which rotate and rollover as a result of centrifugal forces or other tripping mechanisms are not captured in this response.

**Animal**

is selected when a vehicle impacts an animal and that impact causes the vehicle to rollover. This should be a very rare occurrence. Subsequent rollovers due to other tripping mechanisms are not captured in this response.

**Railway vehicle**

is selected when a vehicle involved in a crash with a railway vehicle and the impact causes the vehicle to rollover. A railway vehicle is described as any moving or non-moving vehicle that travels on rails. This includes vehicles that are dual purpose, *i.e.*, a vehicle designed to use both road and rail, if at the time of the crash the vehicle is on rails. Examples are, trolley's on rails and trains.

**Trailer, disconnected in transport**

is selected to report a trailer that has been disconnected from its power unit and subsequently impacted this vehicle and caused the rollover to occur. This will likely occur when a small trailer is involved in a head-on crash with a larger vehicle resulting in a vaulting type rollover. Do not use this attribute if the vehicle rolls over subsequent to an initial impact as centrifugal forces or tripping mechanisms take priority.

**Object fell from vehicle in-transport**

is selected to report an object that was being carried by or was attached to a vehicle in-transport but fell from or became detached from that vehicle and subsequently impacted this vehicle and caused the rollover to occur. Do not use this attribute if the vehicle rolls over subsequent to an initial impact as centrifugal forces or tripping mechanisms take priority.

**Other nonfixed object**

is selected when a nonfixed object, other than those described in the above attributes is impacted and that impact causes a rollover. Do not use this attribute if a vehicle rolls over subsequent to the impact as a result of centrifugal forces or other tripping mechanisms.

**Unknown nonfixed object**

is selected when an unknown nonfixed object is impacted and that impact causes a rollover. Do not use this attribute if a vehicle rolls over subsequent to the impact as a result of centrifugal forces or other tripping mechanisms.

**Other event**

is selected when circumstances exist that cannot be captured in the element values above (*e.g.*, loadshift, high winds).

**Unknown object**

is selected when variable a vehicle rolled over and the cause of the rollover (tripping mechanism) cannot be determined.

## LOCATION ON VEHICLE WHERE INITIATING ROLLOVER FORCE IS APPLIED

Page 1 of 2

**Screen Name:** Rollover Specifics -- Location on Vehicle Where Initiating Rollover Force is Applied

**SAS Data Set:** *GV*

**SAS Variable:** *TRIPLOC*

**Oracle Name:** *VEHICLEROLLOVER.PICKLOCATIONTRIPPINGFORCE*

**Element Attributes:**

Oracle	SAS	
-8888	0	[No Rollover]
1	1	Wheels/tires
2	2	Side plane
3	3	End plane
4	4	Undercarriage
5	5	Other location on vehicle (specify):
6	6	Non-contact rollover forces (specify):
	7	[Not a CDS Vehicle]
8	8	[Rollover-End-over-end]
7	9	Unknown

**Source:** Researcher determined — primary source is vehicle inspection. Secondary sources are scene inspection, photographs, police report, driver interviews, and other interviews.

**Remarks:**

Generally the forces that initiate a rollover are applied at the wheels/tires. Occasionally the tripping force is applied at the undercarriage (*e.g.*, when a vehicle mounts a guardrail) or at the side or end plane (*e.g.*, when a barrier or another vehicle impacts the front or side plane of the vehicle and flips or initiates the rollover sequence). The purpose of this variable is to identify the specific point on the vehicle where the initiating rollover force was applied.

**Wheels/Tires**

is selected whenever the initiating force is applied to the wheels or tires. The most common occurrences involve wheel/tire impacts to potholes and curbs, and wheels that gouge the pavement or dig into the earth.

**Side plane**

is selected whenever the side plane other than the wheels and tires is contacted and that contact initiates the rollover.

**End plane**

is selected whenever the end plane of the vehicle is contacted and sustained the rollover initiating force. For example, a vehicle was traveling at a high rate of speed when it impacted a concrete

median barrier [*i.e.*, Rollover Initiation Object Contacted, equals Concrete traffic barrier] with its front left corner. The barrier redirects the vehicle upward and back towards the roadway. As a result, the vehicle rolls over; therefore use this attribute.

**Undercarriage**

is selected when the rollover was caused by a force acting primarily through the undercarriage plane. For example, a vehicle strikes a guardrail [*i.e.*, Rollover Initiation Object Contacted equals Other traffic barrier (includes guardrail)] with its front right. The vehicle climbs up and over the guardrail and rolls over; therefore use this attribute.

**Other location on vehicle**

is selected when the tripping force is applied at a location that cannot be captured above. This attribute should be rarely used and only after consultation with the zone center.

**Non-contact rollover forces**

is selected when the vehicle roll is precipitated by centrifugal or gravitational forces [*i.e.*, Rollover Initiation Type equals Turn-over or Fall-over]. Specify the non-contact rollover force on the line provided.

**Undercarriage**

is selected when the rollover was caused by a force acting primarily through the through the undercarriage plane. For example, a vehicle strikes a guardrail with its front right. The vehicle climbs up and over the guardrail and rolls over; therefore use this code.

**DIRECTION OF INITIAL ROLL**

**Screen Name:** Rollover Specifics--Direction of Initial Roll

**SAS Data Set:** *GV*

**SAS Variable:** *ROLINDIR*

**Oracle Name:** *VEHICLEROLLOVER.PICKDIRECTIONOFINITROLL*

**Element Attributes:**

Oracle	SAS	
-8888	0	[No Rollover]
1	1	Roll right-primarily about the longitudinal axis
2	2	Roll left-primarily about the longitudinal axis
	7	[Not a CDS Vehicle]
4	8	[Rollover-end-over-end]
3	9	Unknown roll direction

**Source:** Researcher determined — primary sources are the scene and vehicle inspections. Secondary sources are the police report, driver and other interviews.

**Remarks:**

During a side-over-side rollover, generally the corner or roof rail with the maximum crush is the trailing side. Also, grass, dirt or damage to the wheels of the leading edge should be observed. This will be a good indication of a roll to the right or a roll to the left. Striations or directional gouge marks on the vehicle are a good indication of a vehicle's roll along the longitudinal or lateral axis. Physical evidence at the crash scene, including yaw marks, scuffing, or gouging will also provide insight into the direction of the initial roll. It will not be uncommon to combine both vehicle and scene evidence when determining the direction of the initial roll.

**Roll right**

is selected when the vehicle rolls over with the right side leading. This is a clockwise rollover from the driver's view.

**Roll left**

is selected when the vehicle rolls over with the left side leading. This is a counterclockwise rollover from the driver's view.

## ESTIMATED DISTANCE FROM TRIP POINT TO FINAL REST POSITION

Page 1 of 2

**Screen Name:** Estimated distance

**SAS Data Set:**

**SAS Variable:**

**Oracle Name:** *VEHICLEROLLOVER.ESTIMATEDDISTANCE*

**Element Attributes:**

Oracle	SAS	
-8866	888	[No Rollover] Enter to the nearest meter
-9999	999	Unknown
-8887	998	[End-over-end]

**Range:** 1-500+  
500 includes any measured distance above 500 meters

**Source:** Vehicle inspection and scene inspection. A PAR can be a secondary source if a scaled reconstruction of the crash is documented.

**Remarks:**

The purpose of this variable is to determine the **estimated** distance from tripping point to the final rest position of the vehicle that rolled over. The measurement should be obtained along a linear path. Total distance in meters rounded to the nearest whole number, examples 41.4 m = 41 m or 41.5 m = 42 m

This measurement should be measured in the field along the path of the vehicle and the final rest measurement should be taken to the center of gravity (CG) of the vehicle at final rest. The measurements should start from the end of the vehicles tire marks if any are observed.

In cases where an accurate estimate of the distance cannot be obtained, (i.e., vehicle rolled down a ravine or off a cliff) "Unknown" should be coded.

If a vehicle rolls and then slides to final rest, the entire distance from the point of trip to final rest will be measured.

In the situation where the vehicle overturns and climbs a positive embankment and stops, then gravity causes the vehicle to slide or roll down the embankment, code only the distance traveled during the initial roll, (i.e., distance up the embankment.).

See example 1 and 2

**Unknown**

is selected when the researcher could not determine the distance from initial point of roll to final rest.

Example 1

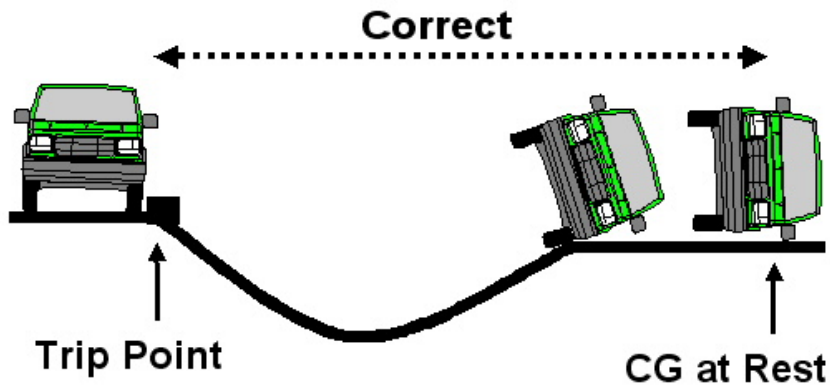

Example 2

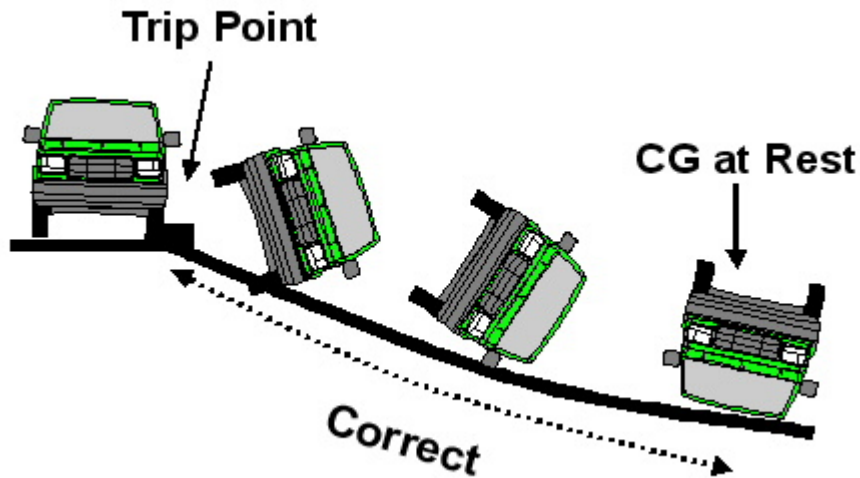

RECONSTRUCTION

General Vehicle Form, Case 2009-903-95732S/ Vehicle #1

VEHICLE | SPECIFICATIONS | OFFICIAL RECORDS | PRECRASH | ROLLOVER | RECONSTRUCTION | DELTA V | LOG | REVIEW

**Heading Angle at Impact For Highest Delta V**

Impact Category

Angle - This Vehicle

Angle - Other Vehicle

**Reconstruction Data**

Towed Trailing Unit

Documentation of Trajectory Data

Post Collision Condition of Tree or Pole

Save Close



**TYPE OF IMPACT FOR HIGHEST DELTA V**

**Screen Name:** Heading Angle at Impact for Highest Delta V--Impact Category

**SAS Data Set:** N/A

**SAS Variable:** N/A

**Oracle Name:** *VEHICLECRASH.PICKHEADINGANGLECAT*

**Element Attributes:**

Oracle	SAS	
1	996	Non Horizontal Impact
2	997	Non Collision
3	998	Impact with Object
4	995	Impact with Vehicle
5	999	Unknown

**Source:** Researcher determined - inputs include vehicle inspection, scene diagram

**Remarks:**

Select the impact category that describes this vehicle's most severe impact. **Note:** when selecting this attribute, parked vehicles are considered vehicles and not objects.

**Non Horizontal impact**

is selected when the Highest Delta V for this vehicle involves a non-horizontal impact. Though rollovers involve non-horizontal forces, select non-collision.

**Non Collision**

is selected when the Highest Delta V for this vehicle involves a Non-collision event.

**Impact with Object**

is selected when a collision with an object results in this vehicle's highest delta V. If this impact is a non-horizontal impact, then select **Non-horizontal impact**.

**Impact with Vehicle**

is selected when this vehicle's highest Delta V impact is with another vehicle. If this impact is a non- horizontal impact, then select **Non-horizontal impact**.

**Unknown**

is selected only when you cannot determine which impact is the highest delta V.

**HEADING ANGLE FOR THIS VEHICLE**

**Screen Name:** Heading Angle at Impact for Highest Delta V--Angle - This Vehicle

**SAS Data Set:** *GV*

**SAS Variable:** *ANGTHIS*

**Oracle Name:** *VEHICLECRASH.HEADINGANGLE*

**Element Attributes:**

Oracle	SAS
	000-355 Code actual value
	888 [Not a CDS Vehicle]
	996 [Non-horizontal impact]
	997 [Non-collision]
	998 [Impact with object]
-9999	999 [Unknown]

**Source:** Scene diagram.

**Remarks:**

Heading Angle for This Vehicle, records the heading angle for this vehicle's highest delta V when this impact was with another vehicle. Heading Angle for Other Vehicle, records the corresponding angle for the other vehicle. Parked vehicles are considered vehicles and not objects.

For vehicle-to-vehicle collisions, use your scene diagram referencing system to determine the heading angles at the point of impact for *this vehicle's* highest delta V. All measurements are referenced to the north arrow on the diagram. The heading angle of each vehicle is determined by projecting the longitudinal axis of the vehicle through the extension of the north arrow. The angle value is obtained by using a 360- protractor and measuring in a clockwise direction from the north arrow, in 5 degree increments. The north arrow always represents 0- (degrees). The angle is a positive value. The following diagrams exemplify the measurement technique.

Heading Angle for This Vehicle (cont'd)

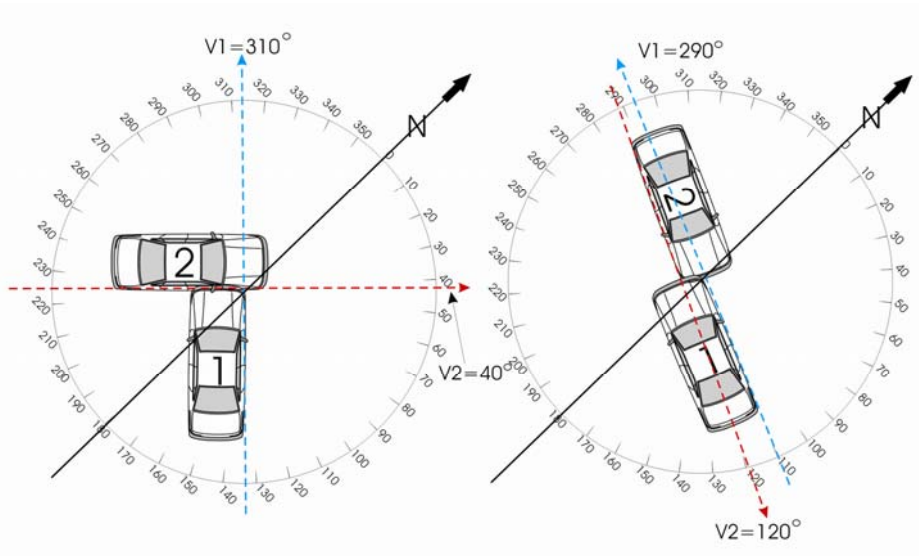

**HEADING ANGLE FOR OTHER VEHICLE**

**Screen Name:** Heading Angle at Impact for Highest Delta V--Angle - Other Vehicle

**SAS Data Set:** *GV*

**SAS Variable:** *ANGOTHER*

**Oracle Name:** *VEHICLECRASH.OTHERHEADINGANGLE*

**Element Attributes:**

Oracle	SAS
	000-355 Code actual value
	888 [Not a CDS Vehicle]
	996 [Non-horizontal impact]
	997 [Non-collision]
	998 [Impact with object]
	-9999 [Unknown]

**Source:** Scene diagram.

**Remarks:**

Heading Angle for Other Vehicle, records the heading angle for the other vehicle's highest delta V when this impact was with another vehicle. Heading Angle for This Vehicle, records the corresponding angle for the other vehicle. Parked vehicles are considered vehicles and not objects. For vehicle-to-vehicle collisions, use your scene diagram referencing system to determine the heading angles at the point of impact for *the other vehicle's* highest delta V. All measurements are referenced to the north arrow on the diagram. The heading angle of each vehicle is determined by projecting the longitudinal axis of the vehicle through the extension of the north arrow. The angle value is obtained by using a 360- protractor and measuring in a clockwise direction from the north arrow, in 5 degree increments. The north arrow always represents 0- (degrees). The angle is a positive value.

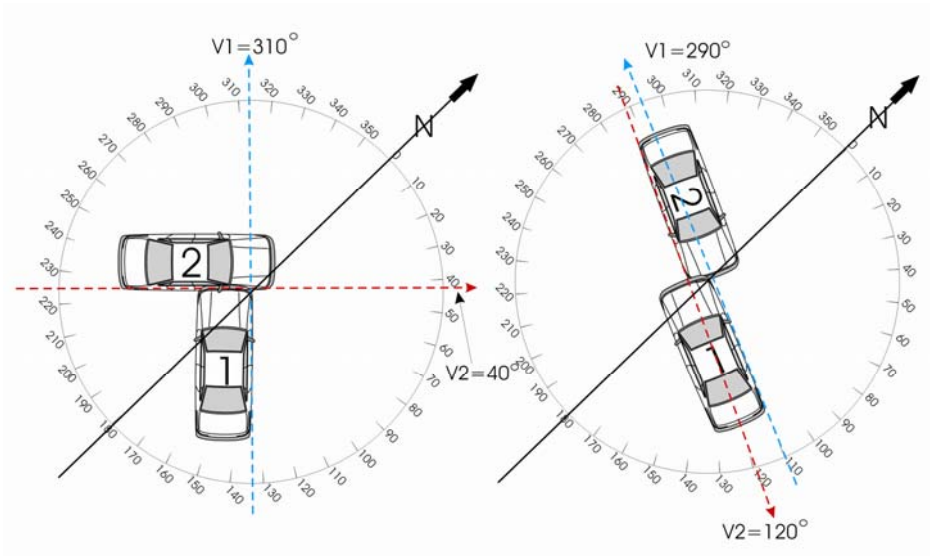

**TOWED TRAILING UNIT**

**Screen Name:** Reconstruction Data--Towed Trailing Unit

**SAS Data Set:** *GV*

**SAS Variable:** *TOWHITCH*

**Oracle Name:** *VEHICLECRASH.PICKTOWEDUNIT*

**Element Attributes:**

Oracle	SAS	
1	0	No Towed Unit
2	1	Yes, Towed Trailing Unit
	8	[Not a CDS Vehicle]
3	9	Unknown

**Source:** Vehicle inspection, interviews, and police report.

**Remarks:**

A trailing unit attached by a fixed linkage includes horse trailers, fifth wheel trailers, travel trailers, camper trailers, boat trailers, truck trailers, towed motor vehicles, or any other trailer.

If this variable is **Yes — towed trailing unit**, then enter the weight of the trailer as well as any cargo it may be carrying in variable Vehicle Cargo Weight.

**No towed unit**

is selected when a trailing unit is not being towed by this CDS applicable vehicle.

**Yes — towed trailing unit**

is selected when a trailing unit is being towed by this CDS applicable vehicle.

**Unknown**

is selected when it is uncertain if there was a towed trailing unit.

## DOCUMENTATION OF TRAJECTORY DATA

**Screen Name:** Reconstruction Data--Documentation of Trajectory Data

**SAS Data Set:** *GV*

**SAS Variable:** *DOCTRAJ*

**Oracle Name:** *VEHICLECRASH.PICKTRAJECTORYDOC*

**Element Attributes:**

Oracle	SAS	
1	0	No
2	1	Yes
	8	[Not a CDS Vehicle]

**Source:** Researcher determined — inputs include scene inspection, vehicle inspection, police report, and interviews.

**Remarks:**

The purpose of this variable is to assess the availability of crash induced physical evidence for impact and final rest, including multiple impacts.

**No**

means there was insufficient crash induced physical evidence to **know or approximate** the point of impact and final rest position for this vehicle's Highest Delta V CDC.

**Yes**

is selected when sufficient crash induced physical evidence is available to **know or approximate** the point of impact and final rest position for this vehicle's Highest Delta V CDC, independently of whether the WinSMASH program trajectory algorithm could be used (*e.g.*, multiple impacts, missing vehicle, etc.).

For multiple impacts assess this variable with respect to the highest delta V impact. To code "Yes" the point of impact must be known as well its next point of impact or, if the highest delta V impact is the last impact for this vehicle, its final rest position.

When a non-horizontal and/or rollover type collision is the highest delta V impact for this vehicle, use **Yes** if the point of impact (trip point or first contact) and final rest position are known.

The word "approximated" as used above means that the impact and final rest positions do not need to be known precisely, but they are reasonably accurate based on the available physical evidence.

## POST COLLISION CONDITION OF TREE OR POLE

Page 1 of 2

**Screen Name:** Reconstruction Data--Post Collision Condition of Tree or Pole

**SAS Data Set:** *GV*

**SAS Variable:** *CONDTREE*

**Oracle Name:** *VEHICLECRASH.PICKPOSTCONDITIONOBJECT*

**Element Attributes:**

Oracle	SAS	
1	0	Not Collision (for Highest Delta V) with tree or pole
2	1	Not damaged
3	2	Cracked/Sheared
4	3	Tilted < 45 Degrees
5	4	Tilted >= 45 Degrees
6	5	Uprooted Tree
7	6	Separated pole from base
8	7	Pole replaced
9	8	Other (specify)
	88	[Not a CDS Vehicle]
10	99	Unknown

**Source:** Researcher determined - input includes vehicle and scene inspection, PAR, interviews, official records.

**Remarks:**

This variable records the condition of the struck **Tree, Pole** or **Post** for this vehicle's most severe impact.

**Not collision (for highest Delta V) with tree or pole**

is selected when the Object Contacted, that produced this vehicle's most severe impact was not with a tree or pole (*e.g.*, vehicle-to-vehicle collision).

**Not damaged**

is selected when the tree or pole has no visible damage or minor surface damage.

**Cracked/sheared**

is selected when the pole or tree is cracked (10% or more of the fibers), sheared, or bent. Bent and cracked poles may be tilted and the bending/cracking can be at any height. This **Tree, Pole** or **Post** attribute takes precedence over Tilted < 45 degrees, Tilted ≥ 45 degrees, and Uprooted tree. Fallen limbs do not constitute "cracked" for a tree; the assessment is made at the tree's trunk. This *does not* describe metal breakaway poles sheared at their base [see (Separated pole from base)].



**Tilted < 45 degrees**

is selected when the pole or tree that is inclined at less than a 45 degree angle as a result of this collision. If the tree/pole is also cracked, then use **Cracked/sheared**).

**Tilted >= 45 degrees**

is selected when the pole or tree that is inclined at a 45 degree angle or greater as a result of this collision. If the tree/pole is also cracked, then use **Cracked/sheared**).

**Uprooted tree**

is selected when the tree was completely or partially torn out of the ground; the tree trunk remained intact; however, the root system was pulled from the soil.

**Breakaway pole separated from base**

is selected when the breakaway pole has sheared or separated at the point where it was designed to do so.

**Pole replaced**

is selected when a replacement pole has been installed and insufficient data exist to categorize the damage to the original pole. This attribute takes precedence over **Unknown**.

**Other (specify)**

is selected when the **Tree, Pole** or **Post** damage cannot be captured by the preceding attributes.

**Unknown**

is selected when no data can be obtained regarding the **Tree, Pole** or **Post**.

DELTA V

The completion of the variables on the Delta V tab depends on whether or not the vehicle was inspected (i.e., General Vehicle Tab “Vehicle Type of Inspection”).

If the vehicle inspection is NOT completed and a missing vehicle WinSMASH run was completed, the Researcher will complete the variables on the Delta V tab of the General Vehicle Form. The data used will be for the highest Delta V calculated for this vehicle.

If the vehicle is at least partially inspected, the delta V information will be entered on the Vehicle Exterior Form/CDC tab/Detail subtab.

**EVENT NUMBER FOR HIGHEST SEVERITY IMPACT**

**Screen Name:** Highest Severity Impact--Event Number

**SAS Data Set:** *GV*

**SAS Variable:** *ACCSEQDV*

**Oracle Name:** *VEHICLECRASH.DELTAVEVENTID*

**Element Attributes:**

Oracle	SAS	
	88	Code sequence number [Not a CDS Vehicle]
-9999	99	Unknown event [Not Inspected]

**Range:** 1-as selected/roll-up

**Source:** Roll-up from Vehicle Exterior Form/CDC, Researcher determined

**Remarks:**

The Event Number that the Researcher selects as the highest severity impact is rolled-up from the Vehicle Exterior Form/CDC. If there is no Vehicle Exterior Form the researcher selects the Event Number for the highest severity impact.

**BASIS FOR COMPUTER GENERATED DELTA V FOR HIGHEST SEVERITY IMPACT**

Page 1 of 4

**Screen Name:** Highest Severity Impact--Basis for Delta V**SAS Data Set:** *GV***SAS Variable:** *HDVBASIS***Oracle Name:** *VEHICLECRASH.PICKDELTAVBASIS***Element Attributes:**

Oracle SAS

**When no Vehicle Inspection is completed:**

0	0	Not Inspected
3	3	SMASH Missing Vehicle

**When vehicle is inspected:****Delta V Calculated:**

1	1	[SMASH - Damage and trajectory]
2	2	[SMASH - Damage only]
3	3	SMASH - Missing vehicle
4	4	[SMASH - Damage with CDC only]

**Delta V Not Calculated**

5	5	At least one vehicle is beyond scope of SMASH
6	6	Rollover
7	7	Other non-horizontal forces
8	8	Sideswipe type damage
9	9	Severe override
10	10	Yielding object
11	11	Overlapping damage
12	12	Insufficient data (specify)
13	98	Other (specify)
	99	[Unknown]

**Source:** [Roll-up from Vehicle Exterior Form/CDC, or selected if vehicle was not inspected.]  
 Researcher determined -- inputs include WinSMASH output (if applicable), vehicle inspection, scene inspection, police report, and photographs.

**Remarks:**

This variable is used to indicate: (1) which NASSMAIN WinSMASH program or routine was used to compute this vehicle's highest delta V or (2) the reason a NASSMAIN WinSMASH program was not applied to the most severe impact.

The Basis for Delta V for the highest severity impact is rolled-up from the Vehicle Exterior Form/CDC when the vehicle(s) involved in the highest severity impact have been inspected to the extent that integrated WinSMASH is used to calculate Delta V values. If one vehicle is inspected and one is not inspected for the highest severity impact, the researcher selects WinSMASH Missing vehicle to input reconstructed Delta V values. If no vehicle(s) is inspected, thus no Exterior Form, for the vehicle(s) involved in the highest severity impact, select "not inspected" and the remaining variables on this tab will be disabled (pre-coded unknown).

**No Vehicle Inspection:****Not Inspected**

This vehicle has no delta V data due to the vehicle not being inspected AND the WinSMASH missing vehicle option is not applicable (i.e., other involved vehicle not inspected, or this is the only vehicle in the crash)

**SMASH - missing vehicle**

This vehicle was not inspected, and the delta V data was generated by the WinSMASH Missing vehicle option using basic information about this vehicle and the inspected vehicle's known damage data.

**Vehicle Inspection Completed:****Delta V Calculated****SMASH - Damage and trajectory**

The WinSMASH output is based on trajectory evidence documented at the scene, in addition to complete vehicle damage.

**SMASH - Damage only**

The WinSMASH output is based upon complete vehicle damage only.

**SMASH - Missing vehicle**

In a two vehicle impact only this vehicle was inspected (damage measurements and CDC obtained), and for the other vehicle, the damage measurements (including CDC) are missing; however, enough data are available to use the WinSMASH Missing Vehicle option.

**SMASH - Damage with CDC only**

The WinSMASH output is based on a two vehicle collision with insufficient vehicle damage documentation. The two vehicle collision must include: one complete vehicle inspection and the other vehicle must have a complete CDC. Additional crush profile information such as the WinSMASH L, "D", etc may be entered to improve the results.

**Delta V Not Calculated****At least one vehicle is beyond scope of SMASH**

One of the vehicles (which may be this vehicle) involved in this impact cannot **be adequately represented** by the parameters in an acceptable reconstruction size/stiffness category (e.g., large truck, motorcycle, bus, etc.). As a general rule in CDS NASS, any vehicle that is not applicable for a CDC is not applicable for the NASSMAIN WinSMASH program

**For the following codes:** All vehicles within scope (CDC applicable) of WinSMASH program but one of the collision conditions is beyond the scope of the WinSMASH program or other acceptable reconstruction techniques, regardless of the adequacy of damage data.

**Rollover**

The involved vehicle fits the vehicle parameters for an acceptable WinSMASH program; however, the rollover collision is beyond the scope of the program.

**Other non-horizontal forces**

The involved vehicle fits the vehicle parameter for an acceptable WinSMASH program; however, the other non-horizontal force is beyond the scope of the program e.g., large object falling on vehicle).

**Sideswipe type damage**

The involved vehicle fits the vehicle parameters for an acceptable WinSMASH program; however, the sideswipe type of collision is beyond the scope of the program.

**Severe override**

The involved vehicle fits the vehicle parameters for an acceptable WinSMASH program; however, the severe override type of collision is beyond the scope of the program.

**Yielding object**

The involved vehicle fits the vehicle parameters for an acceptable WinSMASH program; however, the collision with a yielding object (e.g., sheared utility pole) is beyond the scope of the program.

**Overlapping damage**

The involved vehicle fits the vehicle parameters for an acceptable WinSMASH program; however, collisions involving overlapping damage (i.e., multiple impacts in the same area) are beyond the scope of the program.

Basis for Computer Generated Delta V for Highest Severity Impact (cont'd)

Page 4 of 4

**Insufficient data (specify)**

The involved vehicles and the collision type are applicable for an acceptable WinSMASH program, but due to insufficient data on one or both of the vehicles or object, an acceptable WinSMASH program cannot be used.

**Other (specify)**

Delta V could not be calculated for a reason not identified in the current pick list. The reason must be specified on the line provided.

**TOTAL DELTA V FOR HIGHEST SEVERITY IMPACT**

**Screen Name:** Highest Severity Impact Computer Generated Delta V--Total

**SAS Data Set:** *GV*

**SAS Variable:** *HDVTOTAL*

**Oracle Name:** *VEHICLECRASH.HIGHESTDELTA V*

**Element Attributes:**

Oracle	SAS	
	888	Nearest kmph [Not a CDS vehicle]
999	999	[Unknown]

**Source:** Researcher determined -- Entered from WinSMASH program if the vehicle is not inspected. If inspected, data is rolled-up from Vehicle Exterior Form/CDC,

**Range:** 1-160, 888, 999

**Remarks:**

The Total Delta V for the highest severity impact, automatically generated by the NASSMAIN WinSMASH, is rolled-up from the Vehicle Exterior Form/CDC. If this vehicle was not inspected, and a missing vehicle algorithm was used to calculate the delta V information, the data is entered here.

**999**

is rolled-up from the Vehicle Exterior Form/CDC when the results for this impact are unobtainable.



**LONGITUDINAL DELTA V FOR HIGHEST SEVERITY IMPACT**

**Screen Name:** Highest Severity Impact Computer Generated Delta V--Longitudinal Component

**SAS Data Set:** *GV*

**SAS Variable:** *HDVLONG*

**Oracle Name:** *VEHICLECRASH.HIGHESTLONGDELTA V*

**Element Attributes:**

Oracle	SAS	
		Nearest KMPH
	888	[Not a CDS Vehicle]
999	999	[Unknown]

**Source:** Researcher determined -- Entered from the WinSMASH program if the vehicle is not inspected. If inspected, the data is rolled-up from Vehicle Exterior Form/CDC

**Range:** -160-160, 888, 999

**Remarks:**

The Longitudinal Delta V for the highest severity impact, automatically generated by the NASSMAIN WinSMASH, is rolled-up from the Vehicle Exterior Form/CDC. If this vehicle was not inspected, and a missing vehicle algorithm was used to calculate the delta V information, the data is entered here.

**999**

is rolled-up from the Vehicle Exterior Form/CDC when the results for this impact are unobtainable.

**LATERAL DELTA V FOR HIGHEST SEVERITY IMPACT**

**Screen Name:** Highest Severity Impact Computer Generated Delta V--Lateral Component

**SAS Data Set:** *GV*

**SAS Variable:** *HDVLAT*

**Oracle Name:** *VEHICLECRASH.HIGHESTLATDELTA V*

**Element Attributes:**

Oracle	SAS	
		Nearest kmph
	888	[Not a CDS Vehicle]
999	999	[Unknown]

**Source:** Researcher determined -- Entered from WinSMASH program if vehicle not inspected; If inspected, Rolled-up from Vehicle Exterior Form/CDC

**Range:** -160-160, 888, 999

**Remarks:**

The Lateral Delta V for the highest severity impact, automatically generated by the NASSMAIN WinSMASH, is rolled-up from the Vehicle Exterior Form/CDC. If this vehicle was not inspected, and a missing vehicle algorithm was used to calculate the delta V information, the data is entered here.

**999**

is rolled-up from the Vehicle Exterior Form/CDC when the results for this impact are unobtainable.

**ENERGY ABSORPTION FOR HIGHEST SEVERITY IMPACT**

**Screen Name:** Highest Severity Impact Computer Generated Delta V--Energy Absorption

**SAS Data Set:** *GV*

**SAS Variable:** *HENERGY*

**Oracle Name:** *VEHICLECRASH.HIGHESTENERGY*

**Element Attributes:**

Oracle	SAS	
		Nearest joule
	8888888	[Not a CDS Vehicle]
-9999	9999999	[Unknown]

**Source:** Researcher determined -- Entered from the WinSMASH program if the vehicle is not inspected. If inspected the data is rolled-up from Vehicle Exterior Form/CDC

**Range:** 40-1000000, 8888888, 9999999

**Remarks:**

The Energy Absorption for the highest severity impact, automatically generated by the NASSMAIN WinSMASH, is rolled-up from the Vehicle Exterior Form/CDC. If this vehicle was not inspected, and a missing vehicle algorithm was used to calculate the delta V information, the data is entered here.

**9999999**

is rolled-up from the Vehicle Exterior Form/CDC when the results for this impact are unobtainable.

**IMPACT SPEED FOR HIGHEST SEVERITY IMPACT**

**Screen Name:** Highest Severity Impact Computer Generated Delta V—Impact Speed

**SAS Data Set:** *GV*

**SAS Variable:** *HIMPCTSP*

**Oracle Name:** *VEHICLECRASH.HIGHESTSPPEED*

**Element Attributes:**

Oracle	SAS	
		Nearest kmph
998	998	Damage and Trajectory run not made
	888	[Not a CDS Vehicle]
999	999	[Unknown]

**Source:** Researcher determined -- Rolled-up from Vehicle Exterior Form/CDC

**Range:** 1-160, 888, 998, 999

**Remarks:**

The Impact speed for the highest severity impact, automatically generated by the NASSMAIN WinSMASH (Damage and Trajectory), is rolled-up from the Vehicle Exterior Form/CDC.

**998**

is rolled up from the Vehicle Exterior Form / CDC tab when the impact did not include the Trajectory portion of the WinSMASH program.

**999**

is rolled-up from the Vehicle Exterior Form/CDC when the results for this impact are unobtainable.

## CONFIDENCE LEVEL FOR HIGHEST SEVERITY IMPACT

Page 1 of 2

**Screen Name:** Highest Severity Impact Computer Generated Delta V--Confidence Level

**SAS Data Set:** *GV*

**SAS Variable:** *DVCONFID*

**Oracle Name:** *VEHICLECRASH.PICKDELTACONFIDENCE*

**Element Attributes:**

Oracle	SAS	
1	0	No reconstruction
2	1	Collision fits model — results appear reasonable
3	2	Collision fits model — results appear high
4	3	Collision fits model — results appear low
5	4	Borderline reconstruction
	8	[Not a CDS Vehicle]

**Source:** Researcher determined from WinSMASH program results, vehicle inspection, and scene inspection data.

**Remarks:**

This variable captures the quality of this vehicle's WinSMASH program results for the highest severity impact by evaluating the results, and the data used to create those results, for this impact.

**No reconstruction**

is selected when WinSMASH is not used for the highest severity impact or it is used only to get a Barrier Equivalent Speed or an Estimated Delta V for the highest severity impact.

**Collision fits model - results appear reasonable**

is selected if the results of the WinSMASH in comparison to the actual collision are believed to be within an acceptable range for this impact

**Collision fits model - results appear high**

is selected if the results of the WinSMASH in comparison to the actual collision appear to over represent this impact. For example, vehicle damage is minor (bumper stroke only), and the total delta V is 25 kmph.

**Collision fits model - results appear low**

is selected if the results of the WinSMASH in comparison to the actual collision appear to under represent this impact. For example, vehicle damage is severe (60 centimeters of distributed frontal crush), injury level is high (AIS-3, 4, 5), and the total delta V is 15 kmph.

**Borderline reconstruction**

is selected if the results of the WinSMASH in comparison to the actual collision are within an acceptable range for this impact; however, some collision conditions were borderline for the WinSMASH reconstruction. The attribute is also selected:

- 1) for all *uninspected* vehicles and the involved vehicle whose delta V is determined by the WinSMASH Missing Vehicle and the results appear reasonable;
- 2) when the 6<sup>th</sup> character of the CDC is coded as an "E" (corner impact);
- 3) for all vehicles which have been coded as an override or override.

**BARRIER EQUIVALENT SPEED FOR HIGHEST SEVERITY IMPACT**

**Screen Name:** Barrier Equivalent Speed

**SAS Data Set:** *GV*

**SAS Variable:** *HBAREQSP*

**Oracle Name:** *VEHICLECRASH.HIGHESTBARRIERSPEED*

**Element Attributes:**

Oracle	SAS	
	888	Nearest kmph [Not a CDS Vehicle]
999	999	Unknown

**Source:** WinSMASH program.

**Range:** 1-160, 888, 999

**Remarks:**

Record the Barrier Equivalent speed from the WinSMASH results for this impact, if this vehicle was **not inspected and** a WinSMASH Missing Vehicle algorithm was run. If the vehicle **was inspected**, and WinSMASH was completed, the results will roll up to this screen from the Vehicle Exterior Form / CDC tab.

To generate Barrier Equivalent speed for car to object impacts the WinSMASH program is utilized. For these runs treat the struck object as an immovable barrier.

For car to object impacts where the object moves or sustains damage (poles, trees, large trucks, etc.) or the object is struck (horizontally) during a rollover use the WinSMASH program and treat the object as a rigid barrier.

**ESTIMATED SEVERITY FOR HIGHEST SEVERITY IMPACT**

**Screen Name:** Estimated Highest Delta V--Researcher Determined

**SAS Data Set:** *GV*

**SAS Variable:** *HDVEST*

**Oracle Name:** *VEHICLECRASH.ESTDELTA V*

**Element Attributes:**

Oracle	SAS	
1	0	Reconstruction Delta V coded

**Estimated Delta V**

2	1	Less than 10 kmph
3	2	Est. Delta V->= 10 kmph < 25 kmph
4	3	Est. Delta V->= 25 kmph < 40 kmph
5	4	Est. Delta V->= 40 kmph < 55 kmph
6	5	Est. Delta V->= 55 kmph

**Other estimates of damage severities**

7	6	Damage severity-Minor
8	7	Damage severity-Moderate
9	8	Damage severity-Severe
	88	[Not a CDS Vehicle]
10	99	Unknown

**Source:** Researcher determined.

**Remarks:**

The value that is in this variable is rolled up from the Vehicle Exterior Form, CDC tab.

If the vehicle was not inspected the variable is automatically pre-coded as either:

- Reconstruction Delta V coded or
- Unknown

based on which selection was made previously on **Basis for Delta V**.



General Vehicle Form, Case 2007-903-90000S/ Vehicle #1

VEHICLE | SPECIFICATIONS | OFFICIAL RECORDS | PRECRASH | DRIVER | ROLLOVER | RECONSTRUCTION | DELTA V | LOG | REVIEW

PSU | ZONE

Reason Vehicle Inspection Not Completed

Save Close

## REASON VEHICLE INSPECTION NOT COMPLETED

Page 1 of 4

**Screen Name:** Reason Vehicle Inspection Not Completed

**SAS Data Set:**

**SAS Variable:**

**Oracle Name:** *GENERALVEHICLELOG.PICKREASONNOTINSPECTED*

**Element Attributes:**

Oracle	SAS	
0	0	Non-CDS applicable vehicle
1	1	Complete inspection
2	2	Partial inspection under repair
3	3	Partial inspection repaired
20	20	Partial inspection Non-Tow
4	4	Partial inspection other (specify)
5	5	Vehicle cannot be located
6	6	Vehicle destroyed
7	7	Vehicle outside study area
8	8	Vehicle impounded
9	9	Vehicle sold
10	10	Hit and Run vehicle
11	11	Owner could not be located
12	12	Owner refusal
13	13	Insurance company refusal
14	14	Attorney refusal or litigation
15	15	Repair or tow facility refusal
16	16	Stolen
17	17	Wrong name/address on PAR
18	18	Caseload/staff turnover
19	19	Other (specify)

**Remarks:**

This attribute reports the inspection type, or describes the primary reason that the vehicle was not inspected. Select the most appropriate attribute.

**Non-CDS applicable vehicle**

Is used when the structured vehicle is not CDS applicable.

Reason Vehicle Inspection Not Completed (cont'd)

Page 2 of 4

**Complete inspection**

Is used when a complete vehicle inspection is obtained. Both the exterior and interior must be completed on an un-repaired vehicle with all measurements and images obtained. Do not use this attribute for vehicles with missing components, or where applicable measurements cannot be obtained.

**Partial inspection – under repair**

Is used when an inspection is obtained, but components have been disassembled or repaired, preventing complete inspection.

**Partial inspection – repaired**

Is used when the inspected vehicle is completely repaired.

**Partial inspection – Non-Tow**

Is used for inspected non-towed vehicles. If the non-towed vehicle is under repair or completely repaired, do not use this attribute.

**Partial inspection – other (specify)**

Is used when only partial inspection data are obtained for reasons not described above, e.g., a tow-truck took the vehicle away during the inspection.

**Vehicle cannot be located**

Is coded when, after numerous attempts, the researcher is unable to discover the location of the vehicle. If the location remains unknown due to refusal of any involved party, do not use this attribute.

**Vehicle destroyed**

Is coded when the vehicle's last location is known, and the researcher determines that the vehicle has been crushed or otherwise destroyed such that no usable data can be obtained through an inspection.

**Vehicle outside study area**

Is coded when the vehicle's location (from the PSU office) is of sufficient distance so that the travel time, when added to the inspection time, will exceed eight hours. If the vehicle is less than three hours driving time from the PSU office, do not code this attribute.

**Vehicle impounded**

Is coded when the police or another official agency has possession of the vehicle for evidentiary purposes, and the researcher is denied access to both the exterior and interior.

## Reason Vehicle Inspection Not Completed (cont'd)

Page 3 of 4

**Vehicle sold**

Is coded when the vehicle has been sold to an unidentified party.

**Hit and Run vehicle**

Is coded when the vehicle departed the crash scene, and no identifying data about the vehicle or its occupants are available.

**Owner could not be located**

Is coded when, after numerous attempts, the owner of the vehicle cannot be contacted and the owner's permission is required to inspect the vehicle. Use this attribute when it is established that the vehicle is in the owner's possession or otherwise under the owner's management, and no other source is available to allow the inspection.

**Owner refusal**

Is coded when it is established that the vehicle is in the owner's possession or otherwise under the owner's management, and the owner has refused to allow the inspection.

**Insurance company refusal**

Is coded when it is established that the vehicle is in the insurance company's possession or otherwise under the insurance company's management, and the insurance company has refused to allow the inspection. Use this attribute to describe salvage yards that require insurance company permission to inspect, but such permission cannot be obtained.

**Attorney refusal or litigation**

Is coded when an attorney, generally as a result of litigation, denies the inspection. In cases where the owner refuses based on attorney advice, do not use this attribute.

**Repair or tow facility refusal**

Is coded when it is established that the vehicle is in the tow or repair facility's possession, and the facility has refused to allow the inspection.

**Stolen**

Is coded when, after the crash, a vehicle is stolen and its location is unknown.

**Wrong name/address on PAR**

Is coded when all contact information for the owner/driver is incorrectly reported on the PAR and the correct information cannot be determined. Researchers should exhaust all investigative avenues before coding this response.

Reason Vehicle Inspection Not Completed (cont'd)

Page 4 of 4

**Caseload/staff turnover**

NOTE: This attribute may only be selected with Zone Center permission. This describes conditions where the majority of the team members depart unexpectedly, or where there are no trained researchers at the team.

**Other (specify)**

Is coded when no other listed choices are applicable. Specify the reason as briefly as possible. This choice should be used very rarely.

PSU REVIEW

General Vehicle Form, Case 2007-996-900015/ Vehicle #1

VEHICLE | SPECIFICATIONS | OFFICIAL RECORDS | PRECRASH | DRIVER | ROLLOVER | RECONSTRUCTION | DELTA V | LOG | REVIEW

PSU REVIEW | ZONE REVIEW

LIST | DETAIL

Field	Original	Suggested
-------	----------	-----------

Save Close

## PSU CASE REVIEW

The case review process is a critical part of NASS quality control. Reviews are completed at the PSU, Zone Center, and NHTSA levels. The NASSMAIN program is equipped with an electronic case review that allows suggested changes to be entered and stored in the case. It is imperative that cases be reviewed in a tab-by-tab manner.

When conducting an electronic case review, it is important to enter the case in the “PSU Review” mode. Select “File” from the menu bar and select “PSU Review” from the opened window. All aspects of the case can be reviewed in this mode, but no changes can be made to the case. The method for suggesting changes varies with the type of data being reviewed.

Fixed variables have drop-down boxes that open a window of attributes from which to choose. In the “PSU Review” mode, select the variable for which a suggested change will be made. When the variable box is shaded blue, push the F5 key on the keyboard. A window will pop up displaying the coded attribute, a suggestion box for recommending a new attribute, and a comment box. The suggestion box will contain the same attribute choices available during data entry. Select the proposed attribute change and, if needed, enter justification for the change in the comment box. A list of the suggested changes is compiled under “Review” on the menu bar.

Case components such as summaries, scene diagrams, or sketches can be viewed in the “PSU Review” mode, but suggestion boxes are not available. Select the “Review” option from the menu bar and select the “Notes” option. A text box appears in which any suggestions can be entered. It is recommended to enter each suggested change on a new line of text to allow for easier reading and for additional comments from the case researcher.

When the review is complete, the case researcher should enter the case through the “Researcher Entry” mode so that potential changes can be made. Suggested variable changes that are agreed upon should be changed in the case. For suggestions with which the case researcher disagrees, justification for retaining the variable as coded may be entered in the comment box. Similarly, justification may be entered for suggestions in the “Notes” section that are not acted upon.

***It is important to leave all case review notes and suggestions in the case for use in zone center review.***

ZONE REVIEW

General Vehicle Form, Case 2007-996-900015/ Vehicle #1

VEHICLE | SPECIFICATIONS | OFFICIAL RECORDS | PRECRASH | DRIVER | ROLLOVER | RECONSTRUCTION | DELTA V | LOG | REVIEW

PSU REVIEW | ZONE REVIEW

LIST | DETAIL

Field	Original	Changed to

Save Close



### **ZONE CENTER REVIEW**

Two types of case review conducted at the zone center are:

1. All variable review OR
2. Key variable/specified review

All aspects of the case are reviewed (all variable review) based upon researcher status as follows:

- Novice (1<sup>st</sup> 20 cases completed)
- Probationary
- Twenty-five percent of experienced researcher cases are reviewed (excludes researchers on probation).

### **All variable review**

All aspects of a case will be reviewed to assess accuracy, completeness, and quality of case with respect to NASS program standards as indicated by source documents and researcher training. Areas of exception as well as deficient performance will be assessed based on NHTSA's established guideline for NASS using the following source documents:

- CDS Coding and Editing Manual
- SAE J224 MAR80 .
- Photography Guideline
- Vehicle Measurement Techniques
- WINSMASH Decision Rules
- Researcher training
- Established NASS Edit Checks

### **Key Variable/Specified review:**

Key variable reviews are performed on cases with variables designated to be of special interest and will typically include the following:

- Pre crash
- Rollover
- WINSMASH
- Restraint systems

All cases are checked to ensure they are applicable and selected based on established sampling rules.

In addition to case review, Zone Center personnel are responsible for the coding and sourcing of official and unofficial medical/injury data.

VEHICLE

Exterior Vehicle Form, Case 2007-996-900015/ Vehicle #1

VEHICLE | TIRE | SPECIFICATIONS | FUEL | FIRE | CRUSH | CDC | EDR | SKETCHES | LOG | REVIEW

**Identification**

Number: 1      Identification Number:

Model Year: 2004      Vehicle Special Use: No Special Use

Make: FORD      Transport Status: In transport

Model: TAURUS

Body Category: Automobiles

Body Type: 4-door sedan, hardtop

Class: Intermediate (wheelbase >= 265 but < 278 cm)

**Weight**

Curb Weight: 1452 kgs

Source: Automotive News

Cargo Weight: 91 kgs

Source: Vehicle inspection

**Inspection**

Complete Inspection

Date: 01/14/2007

Save Close

**VEHICLE NUMBER**

**Screen Name:** Number

**SAS Data Set:** *ALL (except ACCIDENT, ACCDESC, EVENT, ACCDER, EMS, SPECSTDY)*

**SAS Variable:** *VEHNO*

**Oracle Name:** *VEHICLE.VEHICLENUMBER*

**Element Attributes:**  
Generated Number

**Range:**

**Source:** Generated when vehicle is selected to open General Vehicle Form.

**Remarks:**

**VEHICLE MODEL YEAR**

**Screen Name:** Identification--Model Year

**SAS Data Set:** *GV*

**SAS Variable:** *MODELYR*

**Oracle Name:** *VEHICLE.MODELYEAR*

**Element Attributes:**

Oracle SAS  
1900 - current data collection year plus one  
-9999 9999 Unknown

**Range:** 1900 (current year+1)

**Source:** Primary source is the VIN during vehicle inspection; secondary sources include the police report and interviews.

**Remarks:**

Select the model year for which the vehicle was manufactured.

**Unknown**

if the vehicle model year cannot be determined.

**VEHICLE MAKE**

**Screen Name:** Identification--Make

**SAS Data Set:** *GV*

**SAS Variable:** *MAKE (for SAS code); OMAKE (for Oracle code)*

**Oracle Name:** *VEHICLE.MAKEID*

**Element Attributes:**

Vehicle Make-as Selected

Unknown

**Source:** Vehicle inspection, police report, and interview

**Remarks:**

Select the vehicle make for this vehicle.

**Unknown**

is used for a "hit-and-run" vehicle unless reliable evidence indicates the make of the vehicle.

See appendix for list of makes.

**VEHICLE MODEL**

**Screen Name:** Identification—Model

**SAS Data Set:** *GV*

**SAS Variable:** *MODEL (for SAS code); OMODEL (for Oracle code)*

**Oracle Name:** *VEHICLE.MODELID*

**Element Attributes:**

Vehicle Model-as Selected  
Unknown

**Source:** Vehicle inspection, police report, and interview

**Remarks:**

Select the vehicle model for this vehicle.

**Unknown**

is used for a "hit-and-run" vehicle unless reliable evidence indicates the make of the vehicle.

See appendix for list of Models

**VEHICLE BODY CATEGORY**

Page 1 of 2

**Screen Name:** Body Category**SAS Data Set:** N/A**SAS Variable:** N/A**Oracle Name:** *VEHICLE.PICKVEHICLETYPE***Element Attributes:**

Oracle	SAS
1	Automobiles
2	Automobile Derivatives
3	Utility Vehicles
4	Van Based Light Trucks
5	Light Conventional Trucks
6	Other Light Trucks
7	Buses (Excludes Van Based GVWR ≤ 4,536 kgs)
8	Medium/heavy Trucks
9	Motored Cycles
10	Other Vehicles
-9999	Unknown Body Type

**Source:** Vehicle inspection, police report, interview, VIN**Remarks:****Automobiles**

These light vehicles referred to as automobiles, are designed primarily to transport passengers.

**Automobile Derivatives**

This describes certain passenger cars that have been modified to perform cargo-related tasks.

**Utility Vehicles (< 4,536 kgs GVWR)****Van Based Light Trucks (< 4,536 kgs GVWR)****Light Conventional Trucks (Pickup Style Cab, < 4,536 kgs GVWR)****Other Light Trucks (< 4,536 kgs. GVWR)**

Other Light Trucks are used to describe vehicles that are based upon a conventional light pickup frame, but a commercial or recreational body has been affixed to the frame rather than a pickup box.

**Buses (Excludes Van Based GVWR  $\leq$  4,536 kgs)**

Buses are defined as any medium/heavy motor vehicle designed primarily to transport large groups of passengers.

**Medium/Heavy Trucks (> 4,536 kgs GVWR)**

Medium/Heavy Trucks describe a single unit truck specifically designed for carrying cargo on the same chassis as the cab. They pertain to a truck-tractor designed for towing trailers or semi-trailers. Although towing is their primary purpose, some truck-tractors are equipped with cargo areas located rearward of the cab.

**Motored Cycles (Does Not Include All Terrain Vehicles/Cycles)****Other Vehicles**

Other Vehicles describe all motored vehicles that are designed primarily for off-road use. It is also selected when the body type of the vehicle is unknown.



**BODY TYPE**

**Screen Name:** Body Type

**SAS Data Set:** *GV*

**SAS Variable:** *BODYTYPE*

**Oracle Name:** *VEHICLE.BODYTYPEID*

**Element Attributes:**

**CDS APPLICABLE VEHICLES**

Oracle SAS

**Automobiles**

- 01 01 Convertible (excludes sun-roof, t-bar)
- 02 02 2-door sedan, hardtop, coupe
- 03 03 3-door/2-door hatchback
- 17 17 3-door coupe
- 04 04 4-door sedan, hardtop
- 05 05 5-door/4-door hatchback
- 06 06 Station wagon (excluding van and truck based)
- 07 07 Hatchback, number of doors unknown
- 08 08 Other automobile type (specify):
- 09 09 Unknown automobile type

**Automobile Derivatives**

- 10 10 Auto based pickup (includes El Camino, Caballero, Ranchero, Brat, and Rabbit pickup)
- 11 11 Auto based panel (cargo station wagon, auto based ambulance/hearse)
- 12 12 Large limousine - more than four side doors or stretched chassis
- 13 13 Three-wheel automobile or automobile derivative

**Utility Vehicles (<=4,536 kgs GVWR)**

- 14 14 Compact utility (examples include: 4-Runner, Amigo, Bravada, Bronco [76 and before], Bronco II, Cherokee [84 and after], Defender, Discovery, Dispatcher, Explorer, Geo Tracker, Golden Eagle, Grand Vitara, Jeep CJ-2 - CJ-7, Laredo, Montero, Mountaineer, Navajo, Passport, Pathfinder, Raider, RAV4, RX-300, Renegade, Rocky, Rodeo, S-10 Blazer, S-15 Jimmy, Samurai, Scrambler, Sidekick, Sportage, Thing, Trooper, Trooper II, Wrangler, Xterra, X-90)
- 15 15 Large utility (examples include: Bronco-full-size [78 and after], full-size Blazer, full-size Jimmy, Hummer, Jeep Cherokee [83 and before], Durango, Escalade, Landcruiser, LX450, Navigator, Ramcharger, RangeRover, Scout, Tahoe, Trailduster, Yukon)

Body Type (cont'd)

Page 2 of 12

Oracle SAS

16	16	Utility station wagon (examples include: Chevrolet Suburban, Expedition, Excursion, GMC Suburban, Grand Wagoneer includes suburban limousine, Travelall)
19		Utility, unknown body type
		<b>Van Based Light Trucks (&lt;=4,536 kgs GVWR)</b>
20	20	Minivan (examples include: Aerostar, Astro, Caravan, Expo Wagon, Grand Caravan, Grand Voyager, Lumina APV, Mazda MPV, Mini-Ram, Mitsubishi Minivan, Nissan Minivan, Odyssey, Previa, Quest, Safari, Sienna, Silhouette, Town and Country, Toyota Minivan, Toyota Van, Trans Sport, Vanagon/Camper, Venture, Villager, Vista, Voyager, Windstar)
21	21	Large van (examples include: B150-B350, Beauville, Chateau, Chevy Van, Clubwagon, E150- E350, Econoline, G10-G30, G15-G35, Maxiwagon, Rally Van, Ram, Royal, Sport Van, Sportsman, Tradesman, Vandura, Voyager [83 and before].)
22	22	Step van or walk-in van (<=4,536 kgs GVWR)
23	23	Van based motorhome (<=4,536 kgs GVWR)
24	24	Van based school bus (<=4,536 kgs GVWR)
25	25	Van based other bus (<=4,536 kgs GVWR)
28	28	Other van type (Hi-Cube Van, Kary) (specify):
29	29	Unknown van type
		<b>Light Conventional Trucks (Pickup style cab, &lt;=4,536 kgs GVWR)</b>
30	30	Compact pickup (examples include: Arrow Pickup [foreign], Colt P/U, Courier, D50, Dakota, Datsun/Nissan Pickup, Frontier, Hombre, LUV, Mazda Pickup, Mitsubishi Pickup, Pup, Ram 50, Ranger, S-10 , S-15, Sonoma, Sport Trac, T-10, T-15, Tacoma, Toyota Pickup)
31	31	Large Pickup (examples include: C10-C35, Comanche, D100-D350, F100-F350, Jeep Pickup, K10-K35, R100-R500, R10-R35, Ram Pickup, Sierra, Silverado, T100, V10-V35, W100-W350)
32	32	Pickup with slide-in camper
33	33	Convertible pickup
39	39	Unknown pickup style light conventional truck type
		<b>Other Light Trucks (&lt;=4,536 kgs GVWR)</b>
40	40	Cab chassis based (includes rescue vehicles, light stake, dump, and tow truck)
41	41	Truck based panel
42	42	Light truck based motorhome (chassis mounted)
45	45	Other light conventional truck type
48	48	Unknown light truck type
49	49	Unknown light vehicle type (automobile, utility, van, or light truck)

Body Type (cont'd)

**OTHER VEHICLES**

Oracle SAS

**Buses (Excludes Van Based <=4,536 kgs GVWR)**

- 50 50 School bus (designed to carry students, not cross country or transit)
- 55 55 Buses (Excludes Van Based GVWR ≤ 4,536 kgs)
- 58 58 Other bus type (e.g., transit, intercity, bus based motorhome) (specify)
- 59 59 Unknown bus type

**Medium/Heavy Trucks (> 4,536 kgs GVWR)**

- 60 60 Step van (> 4,536 kgs GVWR)
- 61 61 Single unit straight truck/Cab chassis (4,536 kgs <GVWR<=8,845 kgs)
- 62 62 Single unit straight truck (8,845 kgs <GVWR<=11,793 kgs)
- 63 63 Single unit straight truck (> 11,793 kgs GVWR)
- 64 64 Single unit straight truck, GVWR unknown
- 65 65 Medium/heavy truck based motorhome
- 67 67 Truck-tractor with no cargo trailer
- 68 68 Truck-tractor pulling one trailer
- 69 69 Truck-tractor pulling two or more trailers
- 70 70 Truck-tractor (unknown if pulling trailer)
- 39462 74 Medium/Heavy pickup truck (≥ 4,536 kgs GVWR)
- 78 78 Unknown medium/heavy truck type

**Unknown truck type (light / medium / heavy)**

- 79 79 Unknown truck type (light / medium / heavy)

**Motored Cycles (Does Not Include All-Terrain Vehicles/Cycles)**

- 80 80 Motorcycle
- 81 81 Moped (motorized bicycle)
- 82 82 Three-wheel motorcycle or moped
- 88 88 Other motored cycle (minibike, motor scooter) (specify):
- 89 89 Unknown motored cycle type

**Other Vehicles**

- 90 90 ATV (All-Terrain Vehicle) and ATC (All-Terrain Cycle)
- 91 91 Snowmobile
- 92 92 Farm equipment other than trucks
- 93 93 Construction equipment other than trucks
- 94 94 Low Speed Vehicles (LSV)/Neighborhood Electric Vehicles (NEV)
- 97 97 Other vehicle type

**Unknown Vehicle Type**

- 99 99 Unknown body type

Body Type (cont'd)

Page 4 of 12

**Source:** Vehicle inspection, police report, and interview

**Remarks:**

If the gross vehicle weight rating (GVWR) can not be determined assume it is less than 4,536 kgs. The vehicle stays the same GVWR as it was sampled

**Automobiles**

These light vehicles referred to as automobiles, are designed primarily to transport passengers.

**01 Convertible (excludes sun-roof, t-bar)**

refers to a passenger car equipped with a removable or retractable roof. To qualify for this attribute, the entire roof must open. Convertible roofs are generally fabric; however, removable hardtops are also included. This attribute takes priority over 2-door or 4-door attributes.

**02 2-door sedan, hardtop, coupe**

refers to a passenger car equipped with two doors for ingress/egress and a separate trunk area for cargo (*i.e.*, trunk lid hinged below the backlight). Folding rear seats do not necessarily violate the separate "trunk area" concept.

**03 3-door/2-door hatchback**

refers to a passenger car equipped with two doors for ingress/egress and a rear hatch opening for cargo (*i.e.*, hinged above the backlight). The cargo area is not permanently partitioned from the passenger compartment area.

**17 3-door coupe**

refers to a passenger car equipped with three doors (two front seat and one rear seat) for ingress/egress and a separate trunk area for cargo (*i.e.*, trunk lid hinged below the backlight). Folding rear seats do not necessarily violate the separate "trunk area" concept.

**04 4-door sedan, hardtop**

refers to a passenger car equipped with four doors for ingress/egress and a separate trunk area for cargo (*i.e.*, trunk lid hinged below the backlight). Folding rear seats do not necessarily violate the separate "trunk area" concept.

**05 5-door/4-door hatchback**

refers to a passenger car equipped with four doors for ingress/egress and a rear hatch opening for cargo (*i.e.*, hinged above the backlight). The cargo area is not permanently partitioned from the passenger compartment area.

Body Type (cont'd)

Page 5 of 12

**06 Station wagon (excluding van and truck based)**

refers to a passenger car with an enlarged cargo area. The entire roof covering the cargo area is generally equal in height from front to rear and full height side glass is installed between the C and D-pillars. The rearmost area is not permanently partitioned from the forward passenger compartment area (*e.g.*, "horizontal window shades" to hide cargo do not constitute partitions).

**07 Hatchback, number of doors unknown**

refers to a passenger car with an unknown number of doors for ingress/egress and a rear hatch opening for cargo (*i.e.*, hinged above the backlight). The cargo area is not permanently partitioned from the passenger compartment area.

**08 Other automobile type**

refers to any passenger car that cannot be described by other automobile attributes.

**09 Unknown automobile type**

is used when it is known that the vehicle is a passenger car, but there is insufficient data to determine the type.

**Automobile Derivatives**

This describes certain passenger cars that have been modified to perform cargo-related tasks.

**10 Auto based pickup**

refers to a passenger car based, pickup type vehicle (includes El Camino, Caballero, Ranchero, Brat, and Rabbit pickup). The roof area (and side glass) rearward of the front seats on a station wagon have been removed and converted into a pickup-type cargo box.

**11 Auto based panel**

refers an automotive station wagon that may have sheet metal rearward of the B-pillar rather than glass (cargo station wagon, auto based ambulance/hearse).

**12 Large limousine**

refers to an automobile that has sections added within its wheelbase (more than four side doors) or stretched chassis to increase length and passenger/cargo carrying capacity .

**13 Three-wheel automobile or automobile derivative**

refers to three-wheel vehicles with an enclosed passenger compartment.

Body Type (cont'd)

Page 6 of 12

**Utility Vehicles (<=4,536 kgs GVWR)****also referred to as:**

Multi-purpose vehicles (MPV)

are designed to have off-road capabilities. These vehicles are generally four wheel drive (4 x 4), have increased ground clearance, and are equipped with a strong frame. Four wheel drive automobiles are not considered MPVs.

**14 Compact utility**

refers to a short wheelbase and narrow tracked multi-purpose vehicle designed to operate in rugged terrain (examples include: 4-Runner, Amigo, Bravada, Bronco [76 and before], Bronco II, Cherokee [84 and after], Defender, Discovery, Dispatcher, Explorer, Geo Tracker, Golden Eagle, Grand Vitara, Jeep CJ-2 - CJ-7, Laredo, Montero, Mountaineer, Navajo, Passport, Pathfinder, Raider, RAV4, RX-300, Renegade, Rocky, Rodeo, S-10 Blazer, S-15 Jimmy, Samurai, Scrambler, Sidekick, Sportage, Thing, Trooper, Trooper II, Wrangler, Xterra, X-90).

**15 Large utility**

refers to full-size multi-purpose vehicles primarily designed around a shortened pickup truck chassis. While generally a station wagon style body, some models are equipped with a removable top (examples include: Bronco-full-size [78 and after], full-size Blazer, full-size Jimmy, Hummer, Jeep Cherokee [83 and before], Durango, Escalade, Landcruiser, LX450, Navigator, Ramcharger, RangeRover, Scout, Tahoe, Trailduster, Yukon).

**16 Utility station wagon**

refers primarily to a pickup truck based chassis enlarged to a station wagon (examples include: Chevrolet Suburban, Excursion, GMC Suburban, Travelall, Grand Wagoneer, includes suburban limousine).

**Utility, unknown body type**

is used when it is known that the vehicle is a utility vehicle, but there is insufficient data to determine the specific type. Class of Vehicle is entered as **(Compact utility vehicle)**.

**Van Based Light Trucks (<=4,536 kgs GVWR)**

Light trucks (<=4,536 kgs GVWR) are designed to maximize cargo/passenger area versus overall length. Basically a "box on wheels" these vehicles are identifiable by their enclosed cargo/passenger area and relatively short (or non-existent) hood.

**20 Minivan**

refers to down-sized cargo or passenger vans (examples include: Aerostar, Astro, Caravan, Expo Wagon, Grand Caravan, Grand Voyager, Lumina APV, Mazda MPV, Mini-Ram, Mitsubishi Minivan, Nissan Minivan, Odyssey, Previa, Quest, Safari, Sienna, Silhouette, Town and Country, Toyota Minivan, Toyota Van, Trans Sport, Vanagon/Camper, Venture, Villager, Vista, Voyager, Windstar).

**21 Large van**

refers to a standard cargo or passenger van (examples include: B150-B350, Sportsman, Royal, Maxiwagon, Ram, Tradesman, Voyager [83 and before], E150-E350, Econoline, Clubwagon, Chateau, G10-G30, Chevy Van, Beauville, Sport Van, G15-G35, Rally Van, Vandura). These vans will generally have a larger capacity in both volume and GVWR.

**22 Step van or walk-in van (<=4,536 kgs GVWR)**

refers to a multi-stop delivery vehicle with a GVWR less than or equal to 4,536 kilograms. Examples are the Grumman LLV used by the US Postal Service or the Aeromate manufactured by Utilimaster Motor Corporation.

**23 Van based motorhome (<=4,536 kgs GVWR)**

refers to a van where the chassis and cab portions from the B-pillar forward of this vehicle are the same as in attributes minivan, large van, step van, however, a frame mounted recreational unit is added behind the driver/cab area. This attribute takes priority over attributes minivan and large van.

**24 Van based school bus (<=4,536 kgs GVWR)**

is a passenger van designed to carry students (passengers) to and from educational facilities and/or related functions. The vehicles are characteristically painted yellow and clearly identified as school buses. Use this attribute regardless of whether the vehicle is owned by a school system or a private company. Van based school buses converted for other uses (*e.g.*, church bus) also take this attribute.

**25 Van based other bus (<=4,536 kgs GVWR)**

is a van derivative (*e.g.*, taxi, small local transit) designed to carry passengers for low occupancy functions or purposes. Van based school buses do not use this attribute.

**28 Other van type (Hi-Cube Van, Kary)**

refers to a cargo or delivery van where that chassis and cab portions from the B-pillar forward of this vehicle are the same as in Minivans and Large Vans with a frame mounted cargo area unit added behind the driver/cab area, or if the van cannot be described as a Minivan, Large Van, Step-van or a Van-based motorhome. Annotate the van type when using this attribute. This attribute takes priority over Minivans and Large Vans.

**29 Unknown van type**

is used when it is known that this vehicle is a light van, but its specific type cannot be determined.

**Light Conventional Trucks (Pickup Style Cab, <=4,536 kgs GVWR)**

Light Conventional Trucks are used to describe vehicles commonly referred to as pickup trucks and some of their derivatives. These light trucks are characteristically designed with a small cab containing a single row of seats (extended cabs with additional seats are available for some models), a large hood covering a conventional engine placement, and a separate open box area (approximately 180 to 240 centimeters long) for cargo.

Body Type (cont'd)

Page 8 of 12

**30 Compact pickup**

is used to describe a pickup truck having a width of 178 centimeters or less. (examples include: Arrow Pickup [foreign], Colt P/U, Courier, D50, Dakota, Datsun/Nissan Pickup, Frontier, Hombre, LUV, Mazda Pickup, Mitsubishi Pickup, Pup, Ram 50, Ranger, S-10 , S-15, Sonoma, T-10, T-15, Tacoma, Toyota Pickup).

**31 Large Pickup**

is used to describe a pickup truck having a width of greater than 178 centimeters (examples include: C10-C35, Comanche, D100-D350, F100-F350, Jeep Pickup, K10-K35, R100-R500, R10-R35, Ram Pickup, Sierra, Silverado, T100, V10-V35, W100-W350).

**32 Pickup with slide-in camper**

is used to describe any pickup truck that is equipped with a slide-in camper. A slide-in camper is a unit that mounts within a pickup bed. Pickup bed caps, tonneau covers, or frame mounted campers are not applicable for this attribute.

**33 Convertible pickup**

refers to a pickup truck equipped with a removable or retractable roof. To qualify for this attribute, the entire roof must open. Convertible roofs are generally fabric; however, removable hardtops are also included. This attribute takes priority over compact and large pickups.

**39 Unknown pickup style light conventional truck**

is used when this vehicle is a Light Conventional Trucks, but there is insufficient data to determine the specific attribute.

**Other Light Trucks (<=4,536 kgs. GVWR)**

Other Light Trucks are used to describe vehicles that are based upon a conventional light pickup frame, but a commercial or recreational body has been affixed to the frame rather than a pickup box.

**40 Cab chassis based (includes rescue vehicles, light stake, dump, and tow truck)**

is used to describe a light vehicle with a pickup style cab and a commercial (non-pickup) body attached to the frame. Included are pickup based ambulances and tow trucks.

**41 Truck based panel**

is used to describe a truck based station wagon that has sheet metal rather than glass above the beltline rearward of the B-pillars.

**42 Light truck based motorhome (chassis mounted)**

is used to describe a frame mounted recreational unit attached to a light van or conventional chassis.

**45 Other light conventional truck type**

is used for light conventional trucks that cannot be described elsewhere.



Body Type (cont'd)

Page 9 of 12

**48 Unknown light truck type**

is used when it is known that the vehicle is a light truck chassis based vehicle but insufficient data exist to specify what type of light truck it is.

**49 Unknown light vehicle type (automobile, utility, van, or light truck)**

is used when it is known that the vehicle is a light vehicle, but insufficient data exists to specify what type of light truck it is.

**Buses (Excludes Van Based)**

Buses are defined as any medium/heavy motor vehicle designed primarily to transport large groups of passengers.

**50 School bus**

(designed to carry students, not cross country or transit) is a bus designed to carry passengers to and from educational facilities and/or related functions. The vehicles are characteristically painted yellow and clearly identified as school buses. Use this attribute regardless of whether the vehicle is owned by a school system or a private company. School buses converted for other uses (*e.g.*, church bus) also take this attribute.

**55 Buses (Excludes Van Based GVWR ≤ 4,536 kgs)**

describes a bus body type built on a van based chassis.

**58 Other bus type**

is a transport device designed to carry passengers for longer periods of time, (*e.g.*, transit, intercity, bus based motorhome). These vehicles may be classified as over-the-road, transit, intercity, bus related motorhome (other than school bus based), or other.

**59 Unknown bus type**

is used when it is known the transport device is a bus but there is insufficient data to choose between attributes School bus and Other bus type.

**Medium/Heavy Trucks (> 4,536 kgs GVWR)**

Medium/Heavy Trucks describe a single unit truck specifically designed for carrying cargo on the same chassis as the cab.

They pertain to a truck-tractor designed for towing trailers or semi-trailers. Although towing is their primary purpose, some truck-tractors are equipped with cargo areas located rearward of the cab.

**60 Step van (> 4,536 kgs GVWR)**

defines a single unit enclosed body with a GVWR greater than 4,536 kilograms and an integral driver's compartment and cargo area. Step vans are generally equipped with a folding driver seat mounted on a pedestal and a sliding door for easy ingress/egress.

Body Type (cont'd)

Page 10 of 12

**61 Single unit straight truck/Cab chassis (4,536 kgs <=GVWR <= 8,845 kgs)**

describes a non-articulated truck designed to carry cargo. This vehicle can be described as a cab chassis or a cut away. The gross vehicle weight rating of the vehicle must exceed 4,536 kilograms and be less than or equal to 8,845 kilograms.

**62 Single unit straight truck (8,845 kgs <= GVWR <= 11,793 kgs)**

describes a non-articulated truck designed to carry cargo. The gross vehicle weight rating of the vehicle must exceed 8,845 kilograms and be less than or equal to 11,793 kilograms.

**63 Single unit straight truck (> 11,793 kgs GVWR)**

describes a non-articulated truck designed to transport cargo with a gross vehicle weight rating in excess of 11,793 kilograms. Use this attribute if it is known that the GVWR of a single unit straight truck is greater than 4,536 kilograms but there is insufficient data to specify the type of single unit truck.

**64 Single unit straight truck, GVWR unknown**

is used when the transport vehicle is a single unit straight truck but the GVWR is unknown.

**65 Medium/heavy truck based motorhome**

describes a recreational vehicle mounted on a single unit medium/heavy truck chassis.

**67 Truck-tractor with no cargo trailer**

describes a fifth wheel equipped tractor/trailer power unit with no trailer attached.

**68 Truck-tractor pulling one trailer**

describes a fifth wheel equipped tractor (*i.e.*, power unit of a tractor/trailer combination) pulling one semi-trailer.

**69 Truck-tractor pulling two or more trailers**

describes a fifth wheel equipped tractor (*i.e.*, power unit of a tractor/trailer combination) pulling a semi-trailer plus one or more trailers. These additional trailers may be attached with a standard hitch or a converter dolly (for semi-trailers).

**70 Truck-tractor (unknown if pulling trailer)**

is used when the vehicle is known to be a truck-tractor, but it is unknown if a trailer was being towed or if more than one trailer was being towed.

**74 Medium/Heavy pickup truck ( $\geq$  4,536 kgs GVWR)****78 Unknown medium/heavy truck type**

is used when the only available information indicates a truck of medium/heavy size.

Body Type (cont'd)

Page 11 of 12

**79 Unknown truck type (light/medium/heavy)**

is used when it is known that this vehicle is a truck, but there is insufficient data to classify the vehicle further.

Motorized Cycles (Does Not Include All Terrain Vehicles/Cycles)

**80 Motorcycle**

is used when the vehicle is a two-wheeled open (*i.e.*, no enclosed body) vehicle propelled by an internal combustion engine. Motorcycles equipped with a side car also take this attribute.

**81 Moped (motorized bicycle)**

is used when the vehicle is a motorized bicycle capable of moving either by pedaling or by an internal combustion engine.

**82 Three-wheel motorcycle or moped**

is used when the vehicle is a three-wheeled open vehicle propelled by an internal combustion engine or a three-wheeled motorized bicycle capable of moving either by pedaling or by an internal combustion engine.

**88 Other motored cycle (minibike, motor scooter)**

is used when the vehicle in question does not qualify for attributes **Motorcycles, moped, three wheeled motorcycle or moped** (*e.g.*, motor scooter).

**89 Unknown motored cycle type**

is used when it is known that the vehicle is a motored cycle, but no further data is available.

**Other Vehicles**

Other Vehicles describe all motored vehicles that are designed primarily for off-road use.

**90 ATV (All-Terrain Vehicle) and ATC (All-Terrain Cycle)**

is used for off-road recreational vehicles which cannot be licensed for use on public roadways. ATVs have 4 or more wheels and ATCs have 2 or 3 wheels. Generally, the tires have low pressure and wide profile (*i.e.*, flotation/balloon).

**91 Snowmobile**

refers to a vehicle designed to be operated over snow propelled by an internal combustion engine.

**92 Farm equipment other than trucks**

refers to farming implements other than trucks propelled by an internal combustion engine (*e.g.*, farm tractors, combines, etc.).

Body Type (cont'd)

Page 12 of 12

**93 Construction equipment other than trucks**

refers to construction equipment other than trucks propelled by an internal combustion engine (*e.g.*, bulldozer, road grader, etc.).

**94 Low Speed Vehicles(LSV)/Neighborhood Electric Vehicles (NEV)**

refers to a vehicle that is designed for travel on secondary roads with speed limits equal to or less than 35 mph. LSVs can sometimes resemble golf carts but differ in that they must adhere to Federal Motor Vehicle Safety Standard (FMVSS) 500. Provisions of FMVSS 500 include the following:  
The Vehicle must have:

- Four wheels
- Top speed of at least 20 mph, but it cannot exceed 25 mph
- GVWR less than 3,001 pounds
- Head, turn signal and tail lamps
- Reflex reflectors
- Parking brake
- Rear view mirrors
- Windshield
- Safety belts
- Seventeen (17) character VIN

**97 Other vehicle type**

is used when the motorized vehicle in question does not qualify for **Construction equipment other than trucks, Farm equipment other than trucks, Snowmobile, ATV (All-Terrain Vehicle) and ATC (All-Terrain Cycle)** (*e.g.*, go-cart, dune buggy, "kit" car, etc.).

**Unknown Vehicle Type**

Unknown Vehicle Type describes all motored vehicles where the body type cannot be differentiated among a light vehicle type, bus, medium/heavy truck, motored cycle, or any other motored vehicle type.

**99 Unknown body type**

is used when there is no available information regarding the type of vehicle. This lack of information prohibits the accurate classification of this vehicle within one of the preceding attributes.

**[CLASS OF VEHICLE]**

Page 1 of 5

**Screen Name:** Class of Vehicle**SAS Data Set:** N/A**SAS Variable:** N/A**Oracle Name:** *VEHICLE.PICVEHICLECLASS***Element Attributes:**

Oracle	SAS	
1	1	Subcompact/mini (wheelbase < 254 cm)
2	2	Compact (wheelbase ≥ 254 but < 265 cm)
3	3	Intermediate (wheelbase ≥ 265 but < 278 cm)
4	4	Full size (wheelbase ≥ 278 but < 291 cm)
5	5	Largest (wheelbase ≥ 291 cm)
9	9	Unknown passenger car size
14	14	Compact utility vehicle
15	15	Large utility vehicle (≤ 4,536 kgs GVWR)
16	16	Utility station wagon (≤ 4,536 kgs GVWR)
19	19	Unknown utility type
20	20	Minivan (≤ 4,536 kgs GVWR)
21	21	Large van (≤ 4,536 kgs GVWR)
24	24	Van based school bus (≤ 4,536 kgs GVWR)
28	28	Other van type (≤ 4,536 kgs GVWR)
29	29	Unknown van type (≤ 4,536 kgs GVWR)
30	30	Compact pickup truck (≤ 4,536 kgs GVWR)
31	31	Large pickup truck (≤ 4,536 kgs GVWR)
38	38	Other pickup truck (≤ 4,536 kgs GVWR)
39	39	Unknown pickup truck type (≤ 4,536 kgs GVWR)
45	45	Other light truck (≤ 4,536 kgs GVWR)
48	48	Unknown light truck type (≤ 4,536 kgs GVWR)
49	49	Unknown light vehicle type
50	50	School bus (excludes van based) (> 4,536 kgs GVWR)
58	58	Other bus (> 4,536 kgs GVWR)
59	59	Unknown bus type
60	60	Truck (> 4,536 kgs GVWR)
67	67	Tractor without trailer
68	68	Tractor - trailer(s)
78	78	Unknown medium/heavy truck type
79	79	Unknown light/medium/heavy truck type
80	80	Motored cycle

Class of vehicle (cont'd)

Page 2 of 5

Oracle	SAS	
90	90	Other vehicle
99	99	Unknown

**Source:** Researcher determined — inputs include police report, vehicle inspection, VIN breakdown, and interviews.

**Remarks:**

The Passenger Car Classification Subcommittee, A3B11(1), of the Transportation Research Board, Traffic Records and Accident Analysis Committee, A3B11, assessed size based on the vehicle wheelbase. The guidelines for this classification can be found in the report entitled Recommended Definitions for Passenger Car Size Classification by Wheelbase and Weight, August 1984 by the previously mentioned subcommittee. This variable is the same variable that appears in the Identification section of the Vehicle Tab on the General Vehicle Form and Vehicle Exterior Form.

**Subcompact/mini (wheelbase < 254 cm)**

Choose based upon wheelbase.

**Compact (wheelbase >= 254 but < 265 cm)**

Choose based upon wheelbase.

**Intermediate (wheelbase >= 265 but < 278 cm)**

Choose based upon wheelbase.

**Full size (wheelbase >= 278 but < 291 cm)**

Choose based upon wheelbase.

**Largest (wheelbase >= 291 cm)**

Choose based upon wheelbase.

**Unknown passenger car size**

is used when it is known that a vehicle is a passenger car but the wheelbase is unknown.

**Compact utility vehicle**

refers to vehicle models defined as **Compact utility** under Body Type. Use this attribute if the size of the utility vehicle is unknown.

**Large utility vehicle (<= 4,536 kgs GVWR)**

refers to vehicle models defined as **Large utility** under Body Type. Refers to full-size multipurpose vehicles primarily designed around a shortened pickup truck chassis. While generally a station wagon body style, some models are equipped with a removable top.

Class of vehicle (cont'd)

Page 3 of 5

**Utility station wagon (<= 4,536 kgs GVWR)**

refers to vehicle models defined as **Utility station wagon** under Body Type. This refers primarily to a pickup truck based chassis enlarged to a station wagon.

**Unknown Utility type**

is defined as **Utility, unknown body type** under Body Type. This attribute is used when it is known that the vehicle is a utility vehicle, but there is insufficient data to determine the specific type.

**Minivan (<= 4536 kgs. GVWR)**

refers to vehicle models defined as **Minivan** under Body Type. This refers to down-sized passenger or cargo vans.

**Large van (<= 4536 kgs. GVWR)**

refers vehicle models defined as **Large van** under Body Type. This refers to a standard size cargo or passenger van.

**Van based school bus (<= 4,536 kgs GVWR)**

is a passenger van designed to carry students (passengers) to and from educational facilities and/or related functions. The vehicles are characteristically painted yellow and clearly identified as school buses. Use this attribute regardless of whether the vehicle is owned by a school system or a private company. Van based school buses converted for other uses (e.g., church bus) also take this attribute refers to vehicles defined as **Van based school bus** under Body Type.

**Other van type (<= 4,536 kgs GVWR)**

refers to vehicle models defined as Step van or walk-in van, Van based motorhome, Van based other bus and code Other van type under Body Type.

**Unknown van type (<= 4,536 kgs GVWR)**

is used when it is known that this vehicle is a light van, but its specific type cannot be determined. Refers to vehicles described as **Unknown van type** under Body Type.

**Compact pickup truck**

refers to vehicle models defined as attributes of **Compact pickup truck** in Body Type. This is used to describe a pickup truck having a width of 178 centimeters or less.

**Large pickup truck**

refers to vehicle models defined as **Large pickup truck** under Body Type. This is used to describe a pickup truck having a width greater than 178 centimeters.

**Other pickup truck (<= 4536 kgs GVWR)**

refers to vehicle models defined as **Pickup with slide-in camper** and **Convertible pickup** under Body Type.

Class of vehicle (cont'd)

Page 4 of 5

**Unknown pickup truck (<= 4536 kgs GVWR)**

refers to vehicle models defined as **Unknown pickup style light conventional truck type** under Body Type.

**Other light truck (<= 4536 kgs GVWR)**

refers to vehicle models defined as **Cab, chassis based (includes rescue vehicles, light stake, dump, and tow truck), Truck based panel, Light truck based motorhome (chassis mounted), and Other light conventional truck type** under Body Type.

**Unknown light truck type**

refers to vehicle models defined as **Unknown light truck type** under Body Type.

**Unknown light vehicle type (automobile, utility, van, or light truck)**

refers to vehicle models defined as **Unknown light vehicle type (automobile, utility, van, or light truck)** under Body Type.

**School bus (excludes van based) (> 4536 kgs GVWR)**

refers to those vehicle models defined as **School bus (designed to carry students, not cross country or transit)** under Body Type.

**Other bus (>4,536 kgs GVWR)**

describes those vehicle models included in **Other bus type (e.g., transit, intercity, bus based motorhome)** under Body Type.

**Unknown bus type**

refers to those vehicle models described as **Unknown bus type** under Body Type.

**Truck (> 4,536 kgs GVWR)**

is defined under Body Type, as **Step van (>4,536 kgs GVWR), Single unit straight truck (4,536 kgs < GVWR <= 8,845), Single unit straight truck (8,845 kgs < GVWR <= 11,793), Single unit straight truck (>11,793 kgs GVWR), Single unit straight truck, GVWR unknown and Medium/heavy truck based motorhome.**

**Tractor without trailer**

refers to **Truck-tractor with no cargo trailer** under Body Type.

**Tractor-trailer(s)**

is defined in attributes **Truck-tractor pulling one trailer, Truck-tractor pulling two or more trailers** and **Truck-tractor (unknown if pulling trailer)** under Body Type.



Class of vehicle (cont'd)

Page 5 of 5

**Unknown medium/heavy truck type)**

is used when the only available information indicates a truck of medium/heavy size. Refer to **Unknown medium/heavy truck type** under Body Type.

**Unknown truck type (light/medium/heavy)**

refers to those vehicles described by **Unknown truck type (light/medium/heavy)** under Body Type.

**Motored cycle**

refers to Body Type, **Motorcycle, Moped (motorized bicycle), Three-wheel motorcycle or moped, Other motored cycle (minibike, motorscooter)** and **Unknown motored cycle type**.

**Other vehicle**

refers to all vehicles described by **ATV (All-Terrain Vehicle) and ATC (All-Terrain Cycle), Snowmobile, Farm equipment other than trucks, or Other vehicle type** under Body Type.

**Unknown**

is used when there is a lack of information regarding the type of vehicle. This lack of information prohibits the accurate classification of this vehicle using one of the preceding codes. This attribute is equivalent to Body Type, **Unknown body type**.

**VEHICLE IDENTIFICATION NUMBER (VIN)**

**Screen Name:** Identification--Identification Number

**SAS Data Set:** *GV*

**SAS Variable:** *VIN*

**Oracle Name:** *VEHICLE.VIN*

**Element Attributes:**

00000000000000000000 VIN not required on vehicle  
 Enter the entire or partial VIN, left justify

99999999999999999999 Unknown

**Source:** Primary source is vehicle inspection; a secondary source is the police report.

**Remarks:**

If a vehicle is inspected, the VIN must be obtained from the vehicle. The PAR may be used to obtain a VIN when a vehicle inspection is not required (*i.e.*, non-tow CDS applicable *and* WinSMASH is not applicable; or Body Category, equals **Buses, Medium/Heavy Trucks, Motorcycles, or Other Vehicles**).

Enter the entire VIN; leave "**blank**" any column which does not have a VIN character.

If part of the VIN is missing or not decipherable, leave the column any such character would ordinarily occupy "**blank**".

Use VIN Assist to check the VIN. Additionally, in NASSMAIN the VIN can be checked on the GV Form by going to **Process / VIN Check Routine**.

**00000000000000000000**

enter a "0" in each position for vehicles not required to have a VIN (e.g., go cart).

**99999999999999999999**

if the entire VIN is unknown, or missing enter a "9" in each position.

If the vehicle is a motor home or school bus, the vehicle chassis VIN is coded and the secondary manufacturer's number should be annotated if indicated on the PAR.

Vehicle identification number (cont'd)

Page 2 of 2

If the vehicle is manufactured by the Ford Motor Company (prior to 1980) and the VIN begins or ends with a script, "F", the "F" is not entered. Proceed to the next character, as in the example below.

**VIN:** F 3 U 6 2 S 1 0 0 9 3 2 F  
**CODE:** 3 U 6 2 S 1 0 0 9 3 2

In addition, if any hyphens, periods, or blank spaces are contained in the string of alphanumeric characters, ignore them as in the example below.

**VIN:** S M - E 3 0 7 6 4 2 1  
**CODE:** S M E 3 0 7 6 4 2 1

**VEHICLE SPECIAL USE**

**Screen Name:** Vehicle Special Use

**SAS Data Set:** *GV*

**SAS Variable:** *VEHUSE*

**Oracle Name:** *VEHICLEPRECRASH.PICKSPECIALUSE*

**Element Attribute:**

Oracle	SAS	
0	0	No special use
1	1	Taxi
2	2	Vehicle used as school bus
3	3	Vehicle used as other bus
4	4	Military
5	5	Police
6	6	Ambulance
		Fire Truck
		Emergency Services Vehicle
9	9	Unknown

**Source:** Researcher determined; primary source is the police report; secondary sources include vehicle inspection, and interviewees.

**Remarks:**

**No special use**

is used when no source indicates or implies that this vehicle was applicable to any of the special uses listed below.

**Taxi, Vehicle used as school bus, and Vehicle used as other bus**

are "*this trip*" specific. The vehicle must be "on duty" as either a taxi or as a bus. External identification on the vehicle as a bus or taxi is not sufficient to determine its special use.

**Taxi**

is used when this vehicle was being used during this trip (at the time of the crash) on a "fee-for-hire" basis to transport persons. Most of these vehicles will be marked and formally registered as taxis; however, vehicles which are used as taxis, even though they are not registered (*e.g.*, "Gypsy Cabs"), are included here. **Taxis and drivers which are off-duty** at the time of the crash **are not included**.

***Vehicle used as school bus***

is used if this motor vehicle (**Body Type**, need not equal **School Bus**) satisfies all of the following criteria:

- externally identifiable to other traffic units as a school/pupil transport vehicle. The vehicle may be equipped with flashing lights and/or a sway stop arm, and traffic may be required to stop for the vehicle when occupants enter or exit;
- operated, leased, owned, or contracted by a public or private school-type institution;
- whose occupants, if any, are associated with the institution; and,
- the vehicle is in operation at the time of the crash to and from the school or on a school-sponsored activity or trip.

**Vehicle used as other bus**

is used when this motor vehicle is designed for transporting more than ten persons and does not satisfy all of the above criteria of a school bus.

**Military, Police, Ambulance, and Fire truck or car**

are considered to be in use at all times. Special use means "**in use**" and not necessarily emergency use. External identification to the normal driving public is the sole criterion.

**Military**

is used for any vehicle which is owned by any of the Armed Forces regardless of body type. This attribute includes:

- military police vehicles;
- military ambulances;
- military hearses; and
- military fire vehicles

**Police**

refers to a vehicle equipped with police emergency devices (lights and siren) that is owned or subsidized by any local, county, state or federal government entity. The police vehicle is presumed to be in special use at all times, although not necessarily in "emergency use." Vehicles not owned by a government entity that are used by law enforcement officers (e.g. undercover) are excluded.

**Ambulance**

is used for any readily identifiable (lights or markings) vehicles designed to transport sick or injured persons. The ambulance is presumed to be in special use at all times, although not necessarily in "emergency use."

**Fire truck**

is used for any readily identifiable (lights or markings) vehicles specially designed and equipped to respond to fire, hazmat, medical, and extrication incidents. This attribute includes medium and heavy vehicles such as engines, pumpers, ladder, platform aerial apparatus, heavy rescue vehicles, water tenders or tankers, brush or wilderness firefighting vehicles, etc. Privately owned vehicles, which are not in authorized use, even if equipped with lights, do not qualify (the volunteer firefighter's vehicle).

**Emergency Services Vehicle**

is used for any readily identifiable (lights or markings) vehicles that do not meet the criteria for Ambulance or Fire Truck and are specially designed and equipped to respond to fire, hazmat, medical, and extrication incidents. This attribute includes light vehicles such as sedans, vans, SUVs, pick-ups, trucks, motorcycles, etc. Privately owned vehicles, which are not in authorized use, even if equipped with lights, do not qualify (the volunteer firefighter's vehicle).

**Unknown**

is used when no information is available to determine special use for this trip (e.g., a hit-and-run vehicle).

**TRANSPORT STATUS**

Page 1 of 3

**Screen Name:** Transport Status?

**SAS Data Set:** N/A

**SAS Variable:** N/A

**Oracle Name:** *VEHICLE.INTRANSPORT*

**Element Attributes:**

Oracle	SAS	
1	1	In-Transport
0	2	Not in Transport
2	3	Working Vehicle

**Range:**

**Source:** Researcher determined

**Remarks:**

This is researcher determined and may not necessarily agree with the police report.

If the PAR has conflicting information regarding the vehicle’s transport status, assume the vehicle is in-transport. For example: If the coded box indicates the vehicle was legally parked but the narrative states the vehicle was illegally parked, then consider this vehicle as in-transport.

If there is any doubt as to whether the vehicle is in-transport, notify your Zone Center immediately.

If the PAR is unclear whether the motor vehicle is actually in the act of performing work at the time of the crash, the default is to consider the motor vehicle as **not** working. Careful attention must be taken to review the narrative, diagram and coded boxes, for an accurate determination.

**In Transport**

Is selected when it is determined that the vehicle is in-transport. This means the vehicle is in motion on a Trafficway or any part of the vehicle is within the boundaries of the roadway.

Examples of In Transport vehicles seen in NASS:

1. A police vehicle used to indicate the roadway is closed due to a previous crash or the roadway is impassable because of a pothole or a tree fell across the roadway is

Transport Status (cont'd)

Page 2 of 3

considered to be in transport. The portion of the roadway past the police vehicle is considered to be closed; that is, outside the trafficway.

2. A cement truck depositing its load for a homeowner's driveway or walkway.
3. Friendly neighbor using his pickup truck to plow the roadway in their neighborhood.
4. A passenger vehicle located partially on the roadway and the shoulder.

**Not In-Transport**

Is selected when it is determined that the vehicle is not in-transport. Not in-transport vehicles are defined as:

1. Stationary vehicles outside the boundaries of the roadway.
2. Vehicles in motion outside the trafficway.

Examples of Not In-Transport Vehicles:

1. Lawn service truck spraying fertilizer, etc across homeowner's lawn.
2. Disabled passenger car pulled onto shoulder of roadway.
3. Minivan parked on the street during the hours parking is allowed.
4. Tractor plowing the corn field loses control and strikes the barn.

**Working Vehicle**

Is selected when it is determined that the vehicle was in the act of performing highway construction, maintenance or utility work when it became involved in the crash. This "work" may be located within or outside the trafficway boundaries, including portions of the trafficway closed for construction. This code does not include private construction/maintenance vehicles, or vehicles such as garbage trucks, delivery trucks, taxis, emergency vehicles, tow trucks, etc.

Examples of Working Vehicles include:

1. Steam roller working in a highway construction zone.
2. State highway maintenance crew mowing grass on the roadside.
3. Utility truck performing maintenance on the power lines along the roadway.
4. Highway maintenance vehicle removing ice/snow from the roadway.
5. Private contractor plowing ice/snow from the roadway.
6. Street sweeper sweeping the street.
7. Truck with cherry picker maintaining a traffic signal.
8. Maintenance vehicle painting lane lines on the road. Includes vehicle traveling behind with light(s) flashing.
9. Highway maintenance vehicle performing non-routine work. This includes repairing potholes, removing debris from the roadway, mowing grass in the median, etc.
10. Police vehicles re-directing traffic at a work zone. That is, the police vehicle is stopped across the lane(s) of traffic indicating a work zone is ahead.
11. Private contractor paving the roadway.



Working vehicles do not include personal motor vehicles performing a “neighborly” activity (such as plowing the neighborhood streets). Additionally, vehicles not specifically contracted to AND in the act of performing highway construction, maintenance or utility work are excluded.

When the vehicle is not in the act of performing “work” and involved in a crash, these highway construction, maintenance or utility vehicles are not working vehicles and can be:

1. In-transport when in motion or stopped on a roadway; or
2. Not in-transport when stopped off the roadway.

**Examples:**

Example #1: A vehicle removing ice/snow from the roadway is involved in a crash with a motor vehicle off the roadway. Does this crash qualify for NASS?

Answer: The vehicle is considered to be a working vehicle and therefore, not in-transport. The motor vehicle off the roadway is also considered to be not in-transport. Therefore, this crash does not qualify for the NASS.

Example #2: A highway maintenance vehicle is removing ice/snow from the roadway and strikes and kills a pedestrian. Does this crash qualify for NASS?

Answer: This crash does not qualify because the highway maintenance vehicle is considered a working motor vehicle and by definition is not in-transport as it was doing work at the time of the incident.

Example #3: A highway maintenance vehicle removing ice/snow from the roadway strikes a passenger vehicle also traveling on the roadway. The passenger vehicle sustains disabling damage and was towed from the scene of the crash. Does this crash qualify for NASS?

Answer: This crash qualifies because the passenger vehicle was in-transport and towed due to damage. This is a single vehicle crash.

Example #4: A passenger vehicle traveling along the roadway loses control and strikes a tractor plowing the corn field. Does this qualify for NASS?

Answer: This crash does indeed qualify for NASS. This is a single vehicle crash where the only vehicle involved in the crash is the passenger vehicle.

**CURB WEIGHT**

**Screen Name:** Weight--Curb Weight

**SAS Data Set:** *VEHSPEC*

**SAS Variable:** *CURBWGT*

**Oracle Name:** *VEHICLE.CURBWEIGHT*

**Element Attributes:**

Oracle	SAS	
		Curb weight of vehicle (kgs)
-9999	999999	Unknown

**Range:** 450 – 100,000

**Source:** Researcher determined

**Remarks:**

Enter this vehicle's curb weight.

Do not confuse the rated Gross Vehicle Weight Rating (GVWR) with the curb weight since it is likely to be significantly greater than the curb weight.

"Vehicle" is defined in this variable to mean the same vehicle identified under **Body Type**.

If the **vehicle model** is known, but the engine size is unknown (*e.g.*, 6 or 8 cylinders), code the average between the high and low curb weights for the model and annotate that the "average" was reported.

When the vehicle specifications do not report the vehicle weight with the proper engine size, adjustments must be made. First, try to determine the weight differences from the vehicle specifications. If the weight difference cannot be determined from the specifications, then adjust as follows: 8 cyl. to 6 cyl. - subtract 100 lbs/45 kilograms; 6 cyl. to 4 cyl. - subtract 75 lbs/34 kilograms.

Add 100lb/45 kilograms to the shipping weight to obtain a curb weight on all CDS applicable vehicles.

Towed trailing units are considered cargo weight and not included in the vehicle curb weight.

Curb Weight (cont'd)

Page 2 of 2

**Unknown**

is selected when the curb weight of this vehicle cannot be determined.

**SOURCE OF CURB WEIGHT INFORMATION**

**Screen Name:** Curb Weight Source

**SAS Data Set:** *VEHSPEC*

**SAS Variable:** *CURBSRC*

**Oracle Name:** *VEHICLE.PICKCURBWTSOURCE*

**Element Attributes:**

Oracle	SAS	
-9999	0	[Curb weight unknown]
1	1	AAMA
2	2	Automotive News
3	3	Branham Automobile Reference Book
4	4	Gasoline Truck, Import, Truck and Diesel Truck Index
6	5	Canadian Specifications
5	8	Other (specify)

**Source:** See Remarks

**Remarks:**

The sources for obtaining curb weight information are listed below:

*Passenger Vehicle Specifications*

**American Automobile Manufacturers Association (AAMA)  
of the U.S., Inc.**

300 New Center Building  
Detroit, Michigan 48202

*Automotive News*

**Crain Automotive Group, Inc.**

965 East Jefferson Avenue  
Detroit, Michigan 48207

*Branham Automobile Reference Book*

**Branham Publishing Company**

Post Office Box 1948  
Santa Monica, California 90406-1948

Source of Curb Weight Information (cont'd)

Page 2 of 2

*Gasoline Truck Index, Import Truck Index, and  
Diesel Truck Index*

**Truck Index, Inc.**

Post Office Box 10291

Santa Anna, California 92711

If the specification is not available in the sources listed above, then the automated Canadian specifications may be used for this variable.

If no other information is available, data from brochures obtained from vehicle dealers may be used. This will be entered under the “**Other**” attribute. This should then be listed in the “**Specify**” field.

**CARGO WEIGHT**

**Screen Name:** Weight--Cargo Weight

**SAS Data Set:** *VEHSPEC*

**SAS Variable:** *CARGOWGT*

**Oracle Name:** *VEHICLE.CARGOWEIGHT*

**Element Attributes:**

Oracle	SAS	
		Cargo weight of vehicle (kgs)
-9999	9999	Unknown

**Source:** Researcher determined — inputs include Vehicle Inspection, Interview, PAR, Tow Yard Operator

**Remarks:**

If Towed Trailing Unit, is Yes – towed trailing unit, then the weight of the trailer and its cargo is coded here. Cargo may also be located in the passenger compartment area and/or trunk.

If there is no cargo then enter the value as zero.

Do not include the weight of the occupants in the cargo weight. The weight of the occupants is included (along with cargo and vehicle curb weight) as a component of the single value which represents the vehicle’s combined weight in the integrated WinSMASH Program, if used.

Cargo weight includes optional add on equipment. Code cargo weight only if the total exceeds 100 lbs. Examples are as follows:

- Includes:
  - Tools and tool box(es)
  - Construction equipment
  - Lumber
  - Luggage

- Excludes:
  - Weight of occupants

**Unknown**

is selected if the cargo weight is unknown or if it is unknown if there is cargo in the vehicle.

**SOURCE OF CARGO WEIGHT INFORMATION**

**Screen Name:** Weight--Cargo Weight Source

**SAS Data Set:** *GV*

**SAS Variable:** *CARGOWGT*

**Oracle Name:** *VEHICLE.PICKCARGOWTSOURCE*

**Element Attributes:**

Oracle	SAS	
-9999	0	[Cargo weight unknown]
1	1	Vehicle Inspection
2	2	Interview
3	3	PAR
4	4	Tow Yard Operator
5	8	Other (specify)

**Source:** Researcher determined

**Remarks:**

This reports the source from which the estimate of the cargo weight, in the vehicle at the time of the crash, was obtained.

**INSPECTION TYPE**

**Screen Name:** Inspection - Type of Inspection

**SAS Data Set:** *GV*

**SAS Variable:** *INSPTYPE*

**Oracle Name:** *VEHICLECRASH.PICKINSPECTIONTYPE*

**Element Attributes:**

Oracle	SAS	
1	0	No inspection
2	1	Vehicle fully repaired — no damage evident
7	2	Partial inspection-Non tow
3	3	Partial inspection other (specify)
5	5	Partial inspection-Photos only
6	6	Partial inspection-MY greater than 10 years
4	4	Complete inspection
8	8	[Non CDS vehicle]

**Source:** Researcher determined.

This variable is designed to allow users to identify cases with complete documentation of required damage data (exterior and interior).

**No inspection**

is selected when neither a complete nor a partial inspection of this vehicle was obtained, irrespective of the reason (*e.g.*, refusal, not required, etc.).

**Vehicle fully repaired — no damage evident**

is selected when a vehicle is inspected, but is completely repaired and no exterior or interior damage data is available.

**Partial Inspection-Non Tow**

is used when the vehicle is a non-towed CDS applicable vehicle and a complete exterior inspection was obtained. This includes vehicles older than 10 years that are not towed.

**Partial inspection Other (Specify)**

is selected when any phase of the inspection is not completed. This includes inspection of partially repaired vehicles and non-towed CDS applicable vehicles. The reason for the partial inspection must be annotated in the “Specify” box.



Inspection Type (cont'd)

Page 2 of 2

If the vehicle interior is completely burned out and restraint use cannot be determined then **Partial Inspection** should be selected.

**Partial inspection-Photos only**

is selected when outside source photographs are used. For further information refer to the CDS Digital Photography Guidelines Manual.

**Partial inspection-MY greater than 10 years**

is selected when the vehicle is older than the current data year minus 9 years and was towed. If the model year can not be determined consider the model year as less than 10 years old.

**Complete inspection**

is selected when both the exterior and the interior of the unrepaired vehicle were inspected and all applicable measurements and photographs were obtained.

**DATE OF INSPECTION**

**Screen Name:** Inspection-Date of Inspection

**SAS Data Set:** *N/A*

**SAS Variable:** *N/A*

**Oracle Name:** *VEHICLECRASH.INSPECTIONDATE*

**Element Attributes:**

Date that vehicle was inspected

**Source:** Researcher determined.

The inspection date is the date when a majority of the inspection is complete. This does not count unsuccessful attempts to locate the vehicle.

TIRE OVERVIEW

Federal law requires tire manufacturers to place standardized information on the sidewall of all tires. This information identifies and describes the fundamental characteristics of the tire and also provides a tire identification number for safety standard certification and in case of a recall.

Information on Passenger Vehicle Tires

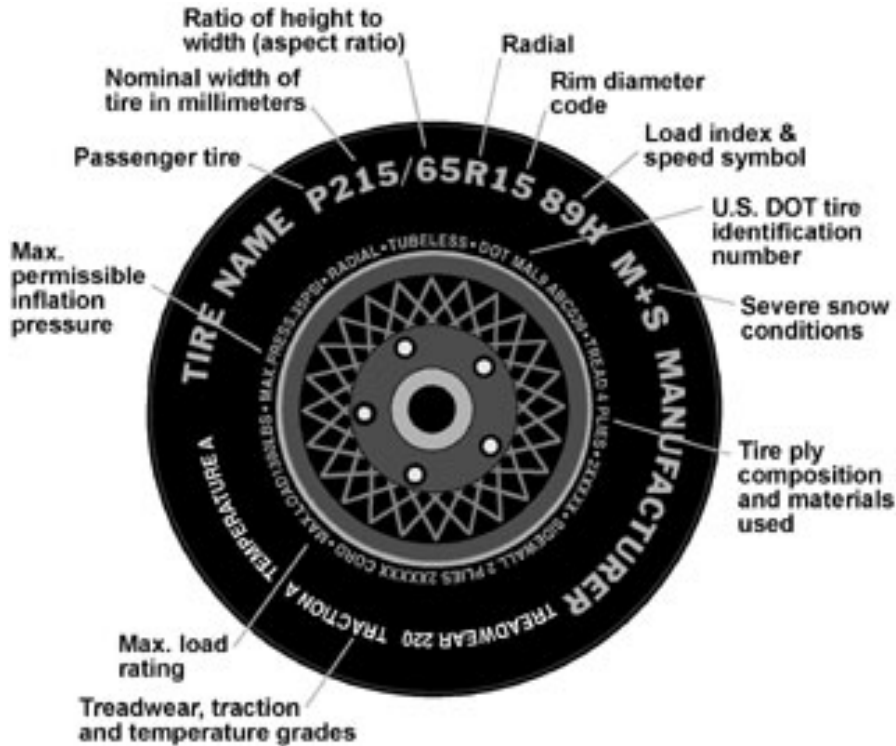

**Tire Size: P215/65R15 89H**

**P**

The "P" indicates the tire is for passenger vehicles.

**Next number (i.e., 215)**

This three-digit number gives the width in millimeters of the tire from sidewall edge to sidewall edge. In general, the larger the number, the wider the tire.

**Tire Size: P215/65R15 89H (cont'd)****Next number (i.e., 65)**

This two-digit number, known as the aspect ratio, gives the tire's ratio of height to width. Numbers of 70 or lower indicate a short sidewall for improved steering response and better overall handling on dry pavement.

**R**

The "R" stands for radial. Radial ply construction of tires has been the industry standard for the past 20 years.

**Next number (i.e., 15)**

This two-digit number is the wheel or rim diameter in inches. If you change your wheel size, you will have to purchase new tires to match the new wheel diameter.

**Next number (i.e., 89)**

This two- or three-digit number is the tire's load index. It is a measurement of how much weight each tire can support. You may find this information in your owner's manual. If not, contact a local tire dealer. Note: You may not find this information on all tires because it is not required by law.

**Speed Rating (i.e., H)**

The speed rating denotes the speed at which a tire is designed to be driven for extended periods of time. The ratings range from 99 miles per hour (mph) to 186 mph. These ratings are listed below. Note: You may not find this information on all tires because it is not required by law.

<b>Letter Rating</b>	<b>Speed Rating</b>
<b>Q</b>	<b>99 mph</b>
<b>R</b>	<b>106 mph</b>
<b>S</b>	<b>112 mph</b>
<b>T</b>	<b>118 mph</b>
<b>U</b>	<b>124 mph</b>
<b>H</b>	<b>130 mph</b>
<b>V</b>	<b>149 mph</b>
<b>W</b>	<b>168* mph</b>
<b>Y</b>	<b>186* mph</b>

\* For tires with a maximum speed capability over 149 mph, tire manufacturers sometimes use the letters ZR. For those with a maximum speed capability over 186 mph, tire manufacturers always use the letters ZR.

**M+S**

The "M+S" or "M/S" indicates that the tire has some mud and snow capability. Most radial tires have these markings; hence, they have some mud and snow capability.

**Information on Light Truck Tires**

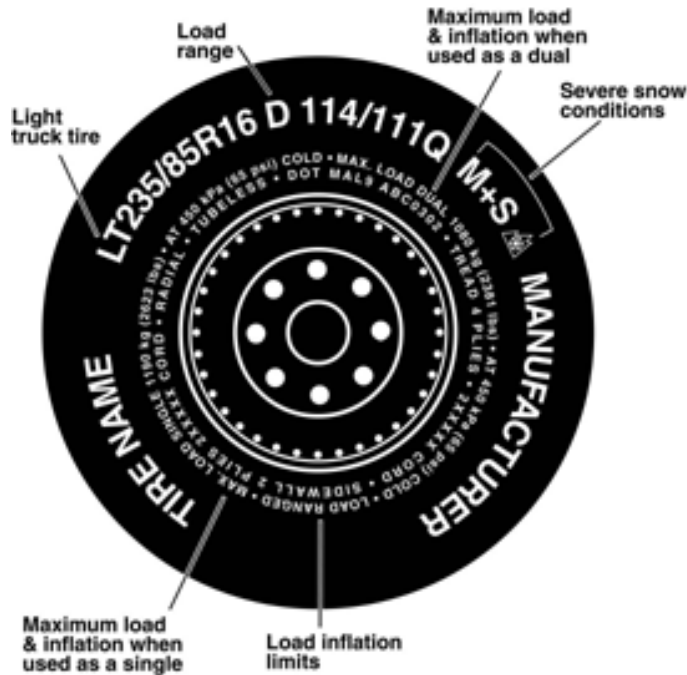

Tires for light trucks have other markings besides those found on the sidewalls of passenger tires.

**LT**

The "LT" indicates the tire is for light trucks.

**Max. Load Dual kg(lbs) at kPa(psi) Cold**

This information indicates the maximum load and tire pressure when the tire is used as a dual, that is, when four tires are put on each rear axle (a total of six or more tires on the vehicle).

**Max. Load Single kg(lbs) at kPa(psi) Cold**

This information indicates the maximum load and tire pressure when the tire is used as a single.

**Load Range**

This information identifies the tire's load-carrying capabilities and its inflation limits.

**Snow Tires**

In some heavy snow areas, local governments may require true snow tires, those with very deeply cut tread. These tires should only be used in pairs or placed on all four wheels. Make sure you purchase snow tires that are the same size and construction type as the other tires on your vehicle.

**Basic Tire Nomenclature**

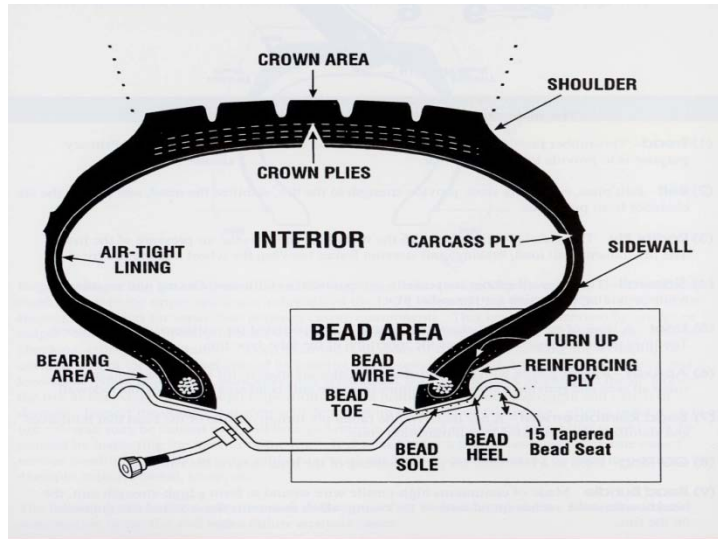

**The Sidewall**

A special rubber compound is used in the sidewall of the tire, which adds flexibility and weathering resistance. Some tires, such as higher end performance tires, may also incorporate steel and/or nylon inserts to provide quicker steering response.

**The Bead**

Tire bead bundles secure the tire to the wheel. They are large monofilament steel cords that are wound together to form a cable or ribbon-type configuration. The casing plies are looped around the bead bundles holding them in place. Bead filler, a rubber compound, is incorporated within the bead configuration and extends up into the sidewall area. The rubber compound used on the outside bead area is usually a hard, durable compound that withstands the rigors of mounting and chafing.

**Grooves**

The grooves are channels for water evacuation between tread and road surface.

**Tread**

Contact area with road surface using various compound strategies like maximizing grip or mileage.

**Shoulder**

The shoulder is a transition element between tread and sidewall for traction during cornering and maneuvering.

**Bead Wire**

A rigid cable serving as an anchor around which body plies are wrapped and which secures tire to rim flange area.

**Air Tight Lining**

Special rubber compound highly impervious to air migration for maintaining air pressure without leaking.

**Crown**

The center area of a tire's tread.

**Sidewall**

The portion of the tire between the bead and the tread. It is flexible to soak up bumps yet stiff to limit tire rollover.

**Bead Heel**

The bead heel is the outer bead edge that fits against the wheel flange.

**Bead Toe**

The bead toe is the inner bead edge closest to the tire centerline.

**Carcass/Casing**

The main body of the tire consisting of wire beads and body plies. The carcass does not include the tread or sidewall rubber.

**[TIRE TO INSPECTION INTERVAL]**

**Screen Name:** Inspection Interval

**SAS Data Set:** N/A

**SAS Variable:** N/A

**Oracle Name:** *VEHICLE\_DERIVED.INSPIINTERVAL*

**Element Attributes:**  
Number of days

**Source:** Calculated field.

This variable is designed to calculate the number of days from crash date to vehicle inspection date.



TIRES GENERAL

Exterior Vehicle Form, Case 2007-996-900015/ Vehicle #1

VEHICLE | TIRE | SPECIFICATIONS | FUEL | FIRE | CRUSH | CDC | EDR | SKETCHES | LOG | REVIEW

GENERAL | TIRES

Total GVWR  kgs

Gross Axle Weight Rating (GAWR) Front  kgs Rear  kgs

Recommended - (pressure in kiloPascals)

	Size	Cold Pressure
Front	<input type="text"/>	<input type="text"/> kPa
Rear	<input type="text"/>	<input type="text"/> kPa

**TOTAL GROSS VEHICLE WEIGHT RATING (KGS)**

**Screen Name:** Total GVWR (kgs)

**SAS Data Set:** *VEHSPEC*

**SAS Variable:** *GVWR*

**Oracle Name:** *VEHICLE.TOTAL\_GVWR*

**Element Attributes:**

Oracle SAS

-9999 9999 Indicate the total GVWR as indicated on the tire or other placard.  
Unknown

**Source:** Vehicle inspection/placard

**Remarks:**

The Gross Vehicle Weight Rating (GVWR) is the maximum permissible total weight of the unit, including the vehicle itself plus all fluids, optional equipment, accessories, all cargo, driver and passengers. The tire placard may be found in any number of places: B-pillar, door, glove compartment door, center console, truck lid, etc.

See the CDS Digital Photography Guidelines for photos of the placard.

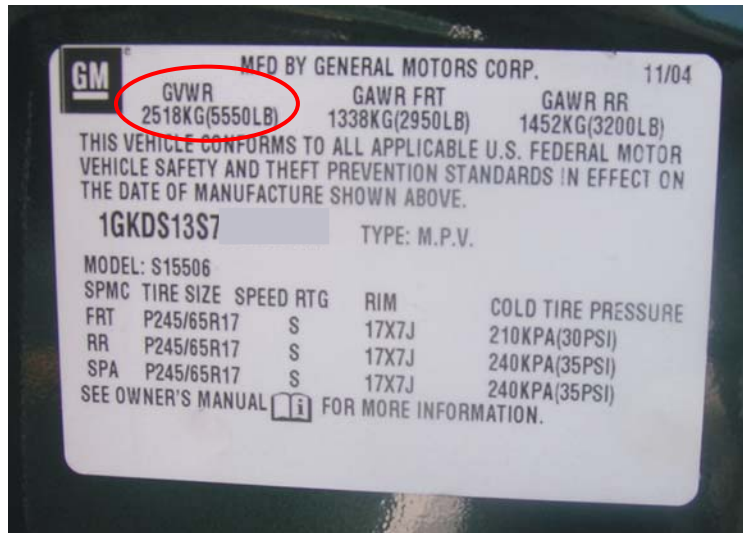

**FRONT GROSS AXLE WEIGHT RATING (KGS)**

**Screen Name:** Gross Axle Weight Rating Front (kgs)

**SAS Data Set:** *VEHSPEC*

**SAS Variable:** *FGAWR*

**Oracle Name:** *VEHICLE.FRONT\_GAWR*

**Element Attributes:**

Oracle SAS

-9999 9999 Indicate the front GAWR as indicated on the tire or other placard.  
Unknown

**Source:** Vehicle inspection

**Range:** 454-2750, 9999

**Remarks:**

The Front Gross Axle Weight Rating (GAWR) is the maximum weight that the front axle, suspension and tire system is designed to carry.

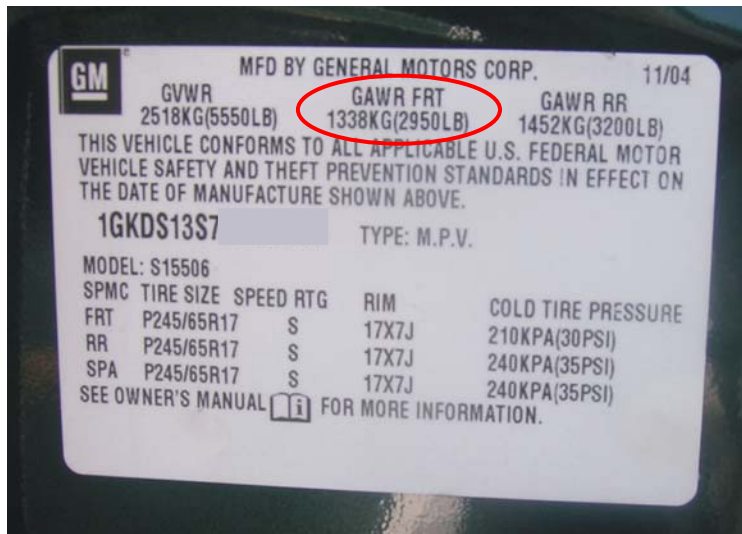

**REAR GROSS AXLE WEIGHT RATING (KGS)**

**Screen Name:** Gross Axle Weight Rating Rear (kgs)

**SAS Data Set:** *VEHSPEC*

**SAS Variable:** *RGAWR*

**Oracle Name:** *VEHICLE.REAR\_GAWR*

**Element Attributes:**

Oracle SAS

Indicate the rear GAWR as indicated on the tire placard.

-9999 9999 Unknown

**Source:** Vehicle inspection

**Range:** 454-3742, 9999

**Remarks:**

The Rear Gross Axle Weight Rating (GAWR) is the maximum weight that the rear axle, suspension and tire system is designed to carry.

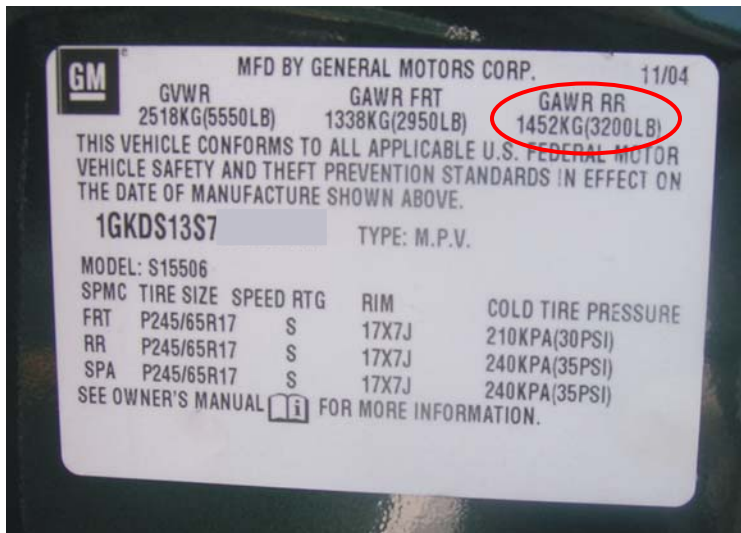

**MANUFACTURER’S RECOMMENDED FRONT/REAR TIRE SIZE**

**Screen Name:** Recommended Front/Rear Size

**SAS Data Set:** *TIRE*

**SAS Variable:** *RECTIRE1, RECTIRE2, RECTIRE3*

**Oracle Name:**  
*TIRESPECIFICATION.FRONTREGTIRESIZE/REARREGTIRESIZE*

**Element Attributes:**

Oracle	SAS	
1	1	P-Metric (specify)
2	2	Light Truck Metric (specify)
3	3	Light Truck High Flotation (specify)
4	4	Light Truck Numeric (specify)
	997	[No Additional Recommendation]
8	8	Other (specify)
-9999	9	Unknown

**Source:** Vehicle inspection from placard on vehicle

**Remarks:**

If the tire size is unknown, but it is known to be a P-metric or LT-light truck tire size, code tire as “Unknown.”

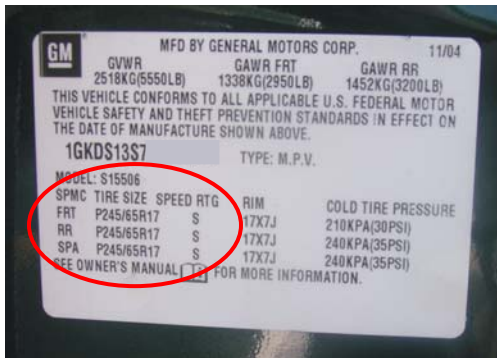

**MANUFACTURER'S RECOMMENDED FRONT/REAR TIRE SIZE**

**Screen Name:** Recommended Front/Rear Size

**SAS Data Set:** *TIRE*

**SAS Variable:** *RECSIZE1, RECSIZE2, RECSIZE3*

**Element Attributes:**

- P-Metric P n n n / n n a n n
- P-Metric (specify)
- Light Truck Metric (specify)
- Light Truck High Flotation (specify)
- Light Truck Numeric (specify)
- Other (specify)
- 999 Unknown
- 997 [No Additional Recommendation]

**Source:** Vehicle inspection from placard on vehicle

**Range:** 69-552, 997,999

**Remarks:**

The tire placard may be found in any number of places: B pillar, door, glove compartment door, center console door, trunk lid, etc.

Placards may list more than one tire size for a vehicle, if so, edit/insert the additional tire. If more than three (3) tires are listed code only the first three (3) listed. Photograph the placard using the CDS Digital Photography Guidelines.

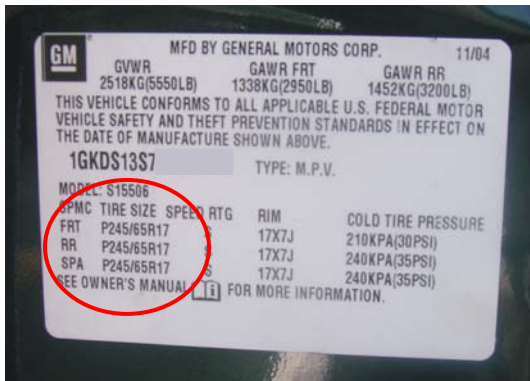

If a character cannot be read then leave a blank space where the character belongs.

**a=alpha value to enter      n=numeric value to enter**  
**P=P-Metric tire *precoded*    LT=Light Truck designation *precoded***  
**Blanks permitted at any location**

P-Metric                      P n n n / n n a n n

P215/65R15, P215/65R15  
P= Passenger Car Tire  
215= Section Width in Millimeters  
65= Aspect Ratio  
R= Radial Construction  
15= Rim Diameter in Inches

Light Truck Metric              L T n n n / n n a n n

LT235/75R15  
LT= Light Truck Tire  
235= Section Width in Millimeters  
75= Aspect Ratio  
R= Radial Construction  
15= Rim Diameter in Inches

Light Truck High Flotation    n n X n n . n n a n n L T

31X10.50R15LT  
31= Tire Diameter in Inches  
10.50= Section Width in Millimeters  
R= Radial Construction  
LT= Light Truck Tire  
15= Rim Diameter in Inches

Light Truck Numeric              n . n n a n n . n L T

8.75R16.5LT  
8.75=Section Width in Inches  
R=Radial Construction  
16.5=Rim Diameter in Inches  
LT=Light Truck Designation

**MANUFACTURER RECOMMENDED COLD TIRE PRESSURE FRONT/REAR (KILOPASCALS)**

**Screen Name:** Recommended (pressure in kilopascals) Front/Rear Cold Pressure

**SAS Data Set:** *TIRE*

**SAS Variable:** *RECPRES1, RECPRES2, RECPRES3*

**Oracle Name:** *TIRESPECIFICATION.FRONTPRESSURE/REARPRESSURE*

**Element Attributes:**

Oracle SAS

Indicate the recommended cold tire pressure for the front/rear tires  
Entry defaults to psi, but may also be entered in kPa

997 [No recommendation]  
-9999 999 Unknown

**Source:** Vehicle inspection

**Range:** 69-552, 997, 999

**Remarks:**

Enter recommended pressure in psi / kPa (program automatically converts psi to kPa).

If the tire placard or owner's manual doesn't specify whether the recommended tire pressure is a hot or cold pressure, assume that it is a cold pressure.





TIRE/TIRES/LIST

Exterior Vehicle Form, Case 2010-903-96S/ Vehicle #1

VEHICLE TIRE SPECIFICATIONS FUEL FIRE CRUSH CDC EDR SKETCHES LOG REVIEW

GENERAL TIRES

LIST DETAIL

Location	Manufacturer	Model	Size	Meas Press	Depth (mm)
RF (Right Front)					
LF (Left Front)					
RR (Right Rear)					
LR (Left Rear)					

Save Close

TIRE/TIRES/DETAIL

Exterior Vehicle Form, Case 2010-903-96S/ Vehicle #1

VEHICLE TIRE SPECIFICATIONS FUEL FIRE CRUSH CDC EDR SKETCHES LOG REVIEW

GENERAL TIRES

LIST DETAIL

Location: LF (Left Front)

Manufacturer: [Dropdown]

Model: [Dropdown]

Size: [Dropdown]

TIN DDT(-R): [Input] [Input] [Input]

Tread Depth: [Input] mm

Meas. Pressure: [Input] kPa

Restricted: [Dropdown]

<< Front >>

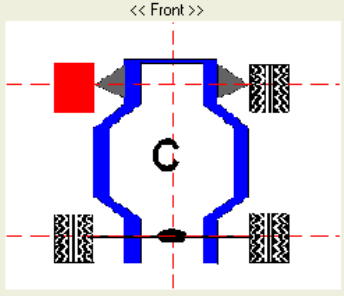

Tire Damage Right Mouse Click on Check Box to View Specify

None  Tire puncture in tread  Sidewall Separation  Tire de-beaded  Other (specify)

Tread Separation  Tire puncture in sidewall  Tire cut/torn  Tire rotted  Unknown

Save Close

**TIRE LOCATION**

**Screen Name:** Location

**SAS Data Set:** *TIRE*

**SAS Variable:** *TLOC*

**Oracle Name:** *VEHICLEWHEELS.WHEELLOCATIONCODE*

**Element Attributes:**

Oracle	SAS	
1	1	RF (Right Front)
2	2	LF (Left Front)
3	3	RR (Right Rear)
4	4	LR (Rear)

**Source:** Vehicle inspection

**Remarks:**

Enter the location of the tire being examined. If there are double tires on a vehicle, only record information on the outer tires.

**TIRE MANUFACTURER**

**Screen Name:** Manufacturer

**SAS Data Set:** *TIRE*

**SAS Variable:** *TMAKE*

**Oracle Name:** *VEHICLEWHEELS.TIREMAKEID*

**Element Attributes:**

Oracle	SAS	
		1-181 (see list)
-8887	887	Tire missing
-8888	888	Other make (specify)
-9999	999	Unknown

**Source:** Vehicle inspection

**Range:** 1-181, 887, 888,999

**Remarks:**

Choose the manufacturer from drop down list. The name of the manufacturer maybe found on the sidewall of the tire. If it cannot be read then indicate "Unknown".

If the tire is missing and cannot be examined then indicate "Tire missing". If the wheel hub is resting on the tire or the tire can be found elsewhere (i.e., in the bed of a pickup) and it can be ascertained that this is the "missing" tire for the vehicle, then indicate the appropriate information about the tire.

Manufacturers that are presently in the database can be found on the following pages.

**EXTERIOR VEHICLE FORM****TIRE/TIRES/DETAIL**

Tire manufacturer (cont'd)

Page 2 of 3

AKURET	1
AMERICAN	2
AMERICAN RADIAL	3
APACHE	4
ARIZONIAN	5
ARMSTRONG	6
ASTRO	7
ATLAS	8
AURORA	9
AVON	10
ALLEGIANCEIV	177
BARUM	11
BFGOODRICH	12
BIG O	13
BILT-MOR	14
BRADLEY	15
BRIDGESTONE	16
BRIGADIER	17
BRUNSWICK	18
CARQUEST	19
CASCADE	20
CAVALIER	21
CEAT	22
CENTENNIAL	23
CHENG SHIN	24
CO-OP	28
CONCORDE	25
CONTENTAL/TAG	26
CONTINENTAL	27
COOPER	29
COOPER-EXPORT	30
CORDOVAN	31
CORNELL	32
COSMO	33
CRESTWOOD	34
CROWN	35
DANZIG	36
DAYTON	37
DEAN	38
DEFINITY	182
DELTA	39
DENMAN	40
DIAMOND	41
DOMINATOR	42
DORAL	43
DOUBLE COIN	44
DOUGLAS	45

DUNLOP	46
DURALON	47
DYNASTAR	48
ELDORADO	49
ELECTRA	50
EMBASSY	51
ESCORT	52
EUROTECH	53
EXXON	54
FALKEN	55
FEDERAL	56
FIRESTONE	57
FISK	58
FORMULA	59
FRONTIER	60
FULDA	61
FUTURA	62
FUZION	183
GENERAL	63
GILLETE	64
GISLAVED	65
GOODRICH	66
GOODYEAR	67
GT TIRE	68
GT TIRE US	69
GUARDIAN	70
GUARDSMAN	71
HALLMARK	72
HANKOOK	73
HERCULES	74
HIGH COUNTRY	75
HOOD	76
HOOSIER	77
JETZON	78
JUPITER	79
K-MART	85
KELLY	80
KELLY- SPRINGFIELD	81
KINGSTAR	82
KIRKLAND	83
KIRKWOOD	84
KUMHO	86
LARAMIE	87
LASSA	88
LEE	89
LEMANS	178

LIBERATOR	179
M&H	90
MABOR	91
MARSHAL	92
MASTERCRAFT	93
MAXXIS	94
MEDALIST	95
MENTOR	96
MERIT	97
MICHELIN	98
MICKY THOMPSON	99
MILLER	100
MITAS	101
MODI	102
MOHAWK	103
MONARCH	104
MONTGOMERY WARD	105
MRF	106
MULTI-MILE	107
NANKANG/BRADLEY	108
NATIONAL	109
NEXEN	184
NITTO	110
NOKIAN	111
NTB	112
OHTSU	113
Other (specify)	8888
PACEMARK	114
PANTHER	115
PARKWAY	116
PARNELLI	117
PATRIOT	118
PEERLESS	119
PENSKE	120
PHILLIPS	121
PIRELLI	122
POLARIS	123
POS-A-TRAC	124
POS-A-TRACTION	125
PATHFINDER	181
PRIMEWELL	185
REGUL	126
RELIANT	127
REMINGTON	128
REPUBLIC	129
REYNOLDS	130

**EXTERIOR VEHICLE FORM**

RIKEN	131
ROAD KING	132
ROADMASTER	133
ROADPRO	134
RUNWAY	135
SEARS	136
SEMPERIT	137
SHELL	138
SIDEWINDER	139
SIEBERLING	140
SIGMA	141
SOLO-TECH	142
SONIC	143
SPARTAN	144
SPORT IV	145
STAR	146
STARFIRE	147

**TIRE/TIRES/DETAIL**

SUMITOMO	148
SUMMIT	149
SUPER SPORT	150
TACOMA	151
TBC	152
TELSTAR	153
TEMCO	154
TIGAR	155
TIRE MISSING	8887
TNT	156
TOSCO 76	157
TOURING SUPREME	158
TOYO	159
TREDTECH	160
TRIBUNE	161
TURNPIKE USA	162
ULTRA-TECH	163

UNION 76	164
UNIROYAL	165
UNIVERSAL	166
Unknown	9999
VANDERBILT	167
VIKING	168
VISA	169
VOGUE	170
VREDESTEIN	171
WESTERN AUTO	172
WINSTON	173
WOOSUNG	174
WYNSTAR	180
YKS	175
YOKOHAMA	176

**TIRE MODEL**

**Screen Name:** Model

**SAS Data Set:** *TIRE*

**SAS Variable:** *TMODEL*

**Oracle Name:** *VEHICLEWHEELS.TIREMODELID*

**Element Attributes:**

Oracle	SAS	
-8888	8	Specify model
-9999	9	Unknown

**Source:** Vehicle inspection

**Remarks:**

The name of the model may be found on the sidewall of the tire. If it cannot be read then indicate "Unknown."

**TIRE TYPE ON VEHICLE**

**Screen Name:** Size

**SAS Data Set:** *TIRE*

**SAS Variable:** *TYPE*

**Oracle Name:** *VEHICLEWHEELS.TIRESIZEID*

**Element Attributes:**

Oracle	SAS	
1	1	P-Metric (specify)
2	2	Light Truck Metric (specify)
3	3	Light Truck High Flotation (specify)
4	4	Light Truck Numeric (specify)
8	8	Other (specify)
-9999	9	Unknown

**Source:** Vehicle inspection

**Remarks:**

**TIRE SIZE ON VEHICLE**

**Screen Name:** Size

**SAS Data Set:** *TIRE*

**SAS Variable:** *SIZE*

**Oracle Name:** *VEHICLEWHEELS.TIRESIZEID*

**Element Attributes:**

Oracle	SAS	
1	1	P-Metric (specify)
2	2	Light Truck Metric (specify)
3	3	Light Truck High Flotation (specify)
4	4	Light Truck Numeric (specify)
8	8	Other (specify)
-9999	9	Unknown

**Source:** Vehicle inspection

**Remarks:**

There will be many characters on the tire sidewall that identify various characteristics of the tire. We are only interested in recording the tire size information. This information is embossed in various ways depending on the type of tire.

*If a character cannot be read then leave a blank space where the character belongs.*

**a=alpha value to enter      n=numeric value to enter  
**P**=P-Metric tire *precoded*    **LT**=Light Truck designation *precoded*  
**Blanks permitted at any location****

P-Metric                      P n n n / n n a n n  
P215/65R15, P215/65R15  
P= Passenger Car Tire  
215= Section Width in Millimeters  
65= Aspect Ratio  
R= Radial Construction  
15= Rim Diameter in Inches



Tire Size On Vehicle (cont'd)

Light Truck Metric                    L T n n n / n n a n n

**LT235/75R15**

LT= Light Truck Tire

235= Section Width in Millimeters

75= Aspect Ratio

R= Radial Construction

15= Rim Diameter in Inches

Light Truck High Flotation    n n X n n . n n a n n L T

**31X10.50R15LT**

31= Tire Diameter in Inches

10.50= Section Width in Millimeters

R= Radial Construction

LT= Light Truck Tire

15= Rim Diameter in Inches

Light Truck Numeric                    n . n n a n n . n L T

**8.75R16.5LT**

8.75=Section Width in Inches

R=Radial Construction

16.5=Rim Diameter in Inches

LT=Light Truck Designation

**TIRE IDENTIFICATION NUMBER**

**Screen Name:** TIN

**SAS Data Set:** TIRE

**SAS Variable:** TIN

**Oracle Name:** VEHICLEWHEELS.TIN

**Element Attributes:**

Specify tire identification number  
99999 9999 9999 Unknown  
Enter characters in each section left justified  
“#” entered for unreadable characters  
3 to 13 characters will be present  
Spaces for places without characters

**Range:** Numbers 0 – 9  
Capital letters except , I, Q, Letters G, O, S and Z are seldom used.  
Spaces for places without characters  
“#” entered for unreadable characters  
3 to 13 characters will be present

**Source:** Vehicle inspection

**Remarks:**

The tire identification number is used to identify the tire manufacturer, tire size, and week of manufacture. The tire identification number may be present in the form of a shortened version or a complete version. It will be preceded by the letters **DOT** or **DOT-R**. These characters might also appear above or below the tire identification number. They are NOT part of the tire identification number.

**Photo documentation of the TIN is required.**

Enter all 9s if the tire identification number is unknown:

9 9 9 9 9    9 9 9 9    9 9 9 9

A complete tire identification number will appear as:

**DOT**    X X X X    X X X X    N N N N  
          1    2                    3                    4

**DOT-R** X X X X    X X X X    N N N N  
          1    2                    3                    4

Tire Identification Number (cont'd)

- 1 Manufacturers assigned identification
- 2 Tire size code
- 3 Tire characteristics or brand name code (OPTIONAL 1-4 characters)
- 4 Date of manufacture (3 digits old standard, 4 digits new standard)

The last section represents the week and year of manufacture. The 1st two symbols identify week. The 3rd and 4th symbols identify year (only one digit for the old tire identification number standard).

Example: 0101 means the 1st week of 2001, or the week beginning Sunday, January 7, 2001, and ending Saturday, January 13, 2001

One side of the tire will have the full tire identification number, the other side will have a partial tire identification number which will not include the date field.

**Only read the tire identification number present on the outside of the tire.**



H Y C 6 \_ \_ 6 1 1 \_ \_ \_ \_ \_

Note missing 3rd section at right. There can't be a 61st week of a year.



Y 6 U R \_ \_ 4 4 2 \_ \_ \_ \_ \_

Note the 2nd section is listed together with 1st section

Tire Identification Number (cont'd)



2 E 0 6 \_ \_ \_ \_ \_ 2 4 0 2

Note that there are attachment points for the plate in the tire mold on either side of "2402".



H 4 H 8 \_ \_ \_ \_ \_ J E N \_ \_ \_ \_ \_ 5 1 0 4



A P H H \_ \_ \_ \_ \_ W H T \_ \_ \_ \_ \_ 2 1 3 \_ \_

**MINIMUM TREAD DEPTH (MM)****Screen Name:** Tread Depth**SAS Data Set:** *TIRE***SAS Variable:** *DEPTH***Oracle Name:** *VEHICLEWHEELS.TREADDEPTH***Element Attributes:**

Oracle SAS

Specify tread depth

Entry defaults to 1/32 inch, but may also be entered in mm

-9999 99 Unknown

**Range:** 0mm - 25mm**Source:** Vehicle inspection**Remarks:**

Indicate the tread depth in 1/32 inch (program automatically converts 1/32 inch to mm).

The Minimum Tire Tread Depth is to be measured using the supplied tire tread depth indicator. The measurement should be taken on the shallowest groove of the tread. Be careful not to measure on a wear bar indicator. The measurement is to be documented to the nearest 32<sup>nd</sup> inch.

If tread depth is measured at 25mm or more, code as 25mm.

**TIRE MEASURED PRESSURE (KILOPASCALS)**

**Screen Name:** Meas. Pressure

**SAS Data Set:** *TIRE*

**SAS Variable:** *PRES*

**Oracle Name:** *VEHICLEWHEELS.MEASUREDPRESSURE*

**Element Attributes:**

Oracle	SAS	
		Specify measured pressure of the tire in psi
		Entry defaults to psi, but may also be entered in kPa
-8882	888	Tire flat
-9999	999	Unknown

**Source:** Vehicle inspection

**Range:** 34-689, 888, 999

**Remarks:**

Enter measured pressure in psi/kpa (program automatically converts psi to kpa).  
The PAR may be used as a source if it contains this data, but on scene data supersedes all other data.

The *Measured Pressure* is to be documented using the supplied air pressure gauge. Adhere to the following instructions when taking and reading the pressure:

The pressure gauge should be cleared before taking the reading. It should be placed over the tire's valve stem and press firmly so that no escaping air is heard. If the vehicle is equipped with dual rear wheels, document only the outboard tires. NOTE: Testing has revealed that a tire will normally lose 0.1 psi for each reading.

Record the pressure of the tire at the time of inspection, regardless of whether the tire has been replaced or re-inflated since the crash.

**TIRE RESTRICTED**

**Screen Name:** Restricted

**SAS Data Set:** *TIRE*

**SAS Variable:** *RESTRCT*

**Oracle Name:** *VEHICLEWHEELS.TIREROTATIONRESTRICTED*

**Element Attributes:**

Oracle	SAS	
2	2	No
1	1	Yes
3	0	Not applicable
4	9	Unknown

**Source:** Vehicle inspection

**Remarks:**

The variable reflects the tire/wheel restriction that occurred as a result of the crash. This variable is being collected for use in modifying input to the WINSMASH computer program.

A restricted tire is a tire that, due to crash forces, is unable to rotate. The tire could be trapped by surrounding vehicle parts or is damaged by the impact. The tire is in a "locked position."

**No**

The wheel/tire was not restricted

**Yes**

The wheel/tire was physically restricted

**N/A**

There is no wheel/tire for this position or if the tire is missing at the time of the vehicle inspection.

**Unknown**

Use this selection when it cannot be determined if the wheel/tire was restricted as a result of the crash

TIRE DAMAGE

Screen Name: Damage

SAS Data Set: TIREDMG

SAS Variable: DAMTYPE

Oracle Name: TIREDDAMAGE.DAMAGEID

Element Attributes:

Oracle	SAS	
-8887	0	None
-9999	99	Unknown
2	1	Tread separation
5	2	Sidewall separation
3	3	Tire puncture in tread
4	4	Tire puncture in sidewall
6	5	Tire cut/torn
8	6	Tire rotted
7	7	De-beaded
77	88	Other (specify)

Source: Vehicle inspection

Remarks: Observations of the tire by the researcher at the time of the vehicle inspection.

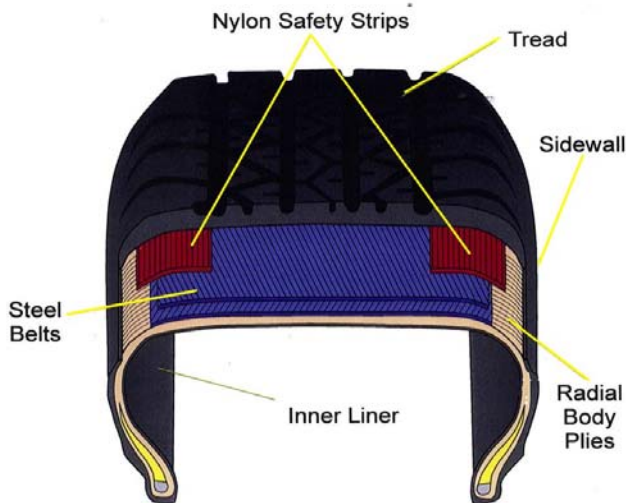

Tread Separation

Tread is the outermost grooved part of the tire that comes in contact with the road. Tread separation occurs when the tread of the tire peels away from the inner liner or the carcass (portion of the tire



that holds air) exposing the inner tire, belts, and cords. This separation makes tire blow out and increases the likelihood an accident will occur.

**Sidewall Separation**

The sidewalls are the portions of the tire between the beads and the tread compounded of rubber with high flex and weather resistance to control the ride and provide support. Sidewall separation means the parting of the rubber compound from the cord material in the sidewall.

**Tire Puncture in Tread**

A hole made by a sharp point object on the Tread of the tire.

**Tire Puncture in Sidewall**

A hole made by a sharp point object on the Sidewall of the tire.

**Tire Cut/torn**

Following pictures show cut/torn tire on the sidewall.

**Tire Rotted**

Rubber degrades when exposed to heat, oxygen, ozone, and other elements. With age, rotted tires develop cracks on the sidewall and tread.

**Tire De-beaded**

The Bead is a structure composed of high tensile strength steel wire formed into hoops which function as anchors for the plies and hold the tire assembly onto the rim of the wheel. An indication of de-beading is a visual separation of the bead from the rim.



Tire Damage (cont'd)

Page 3 of 3

**Other (specify)**

Refers to any damage observed that is not listed. This includes bead separation which is a breakdown of bond between components in the bead area. The bead can be broken or bent. A visual indication of debris lodged between the rim and the bead is noted here.



SPECIFICATIONS

Exterior Vehicle Form, Case 2007-996-900015/ Vehicle #1

VEHICLE | TIRE | SPECIFICATIONS | FUEL | FIRE | CRUSH | CDC | EDR | SKETCHES | LOG | REVIEW

FORD TAURUS 2004

**Original Specifications**

Wheelbase	<input type="text"/>	cms	Front Overhang	<input type="text"/>	cms
Overall Length	<input type="text"/>	cms	Rear Overhang	<input type="text"/>	cms
Maximum Width	<input type="text"/>	cms	Undeformed End Width	<input type="text"/>	cms
Curb Weight	<input type="text" value="1452"/>	kgs	Engine Cylinders	<input type="text" value="4"/>	
Average Track	<input type="text"/>	cms	Displacement	<input type="text" value="3"/>	L

Transmission

Type Of Transmission: Automatic Drive Wheels: Front Wheel Drive (FWD)

Researcher's Assessment of Vehicle Disposition: Towed due to vehicle damage

Justification:

Is This a Multi-Stage Manufactured Vehicle And/Or A Certified Altered Vehicle: No post-manufacturer modifications

Suspected Modifications:

Save Close

**WHEELBASE**

**Screen Name:** Original Specifications—Wheelbase

**SAS Data Set:** *VEHSPEC*

**SAS Variable:** *WHEELBAS*

**Oracle Name:** *VEHICLE.WHEELBASE*

**Element Attributes:**

Oracle	SAS	
		Enter to the nearest centimeter.
-9999	999	Unknown

**Range:** 100 – 650 cms

**Source:** Vehicle specifications, exemplar vehicle

**Remarks:**

The wheelbase dimension is obtained from source materials and not from vehicle measurements. If written vehicle specifications cannot be found, after consultation of the zone center, the researcher may take the measurements from an exemplar vehicle.

The coding of this variable reflects the length of the vehicle's original or undamaged wheelbase to the nearest centimeter.

**Unknown**

is used when this vehicle's original wheelbase cannot be determined.

**OVERALL LENGTH**

**Screen Name:** Original Specifications—Overall Length

**SAS Data Set:** *VEHSPEC*

**SAS Variable:** *OVERALL*

**Oracle Name:** *VEHICLE.OVERALLLENGTH*

**Element Attributes:**

Oracle	SAS	
		Enter to the nearest centimeter.
-9999	999	Unknown

**Range:** 100 – 1000 cms

**Source:** Vehicle specifications, exemplar vehicle

**Remarks:**

Enter the overall length of the vehicle, as determined from source materials, to the nearest centimeter.

Any add-on equipment is excluded from the overall length of the vehicle (i.e., a pick-up with an after-market bumper added).

**Unknown**

is used when this vehicle's original overall length cannot be determined.

**MAXIMUM WIDTH**

**Screen Name:** Original Specifications—Maximum Width

**SAS Data Set:** *VEHSPEC*

**SAS Variable:** *MAXWIDTH*

**Oracle Name:** *VEHICLE.MAXWIDTH*

**Element Attributes:**

Oracle	SAS	
		Enter to the nearest centimeter.
-9999	999	Unknown

**Range:** 100 – 250 cms

**Source:** Vehicle specifications, exemplar vehicle

**Remarks:**

Enter the overall/maximum width of the vehicle, as determined from source materials, to the nearest centimeter.

**Unknown**

is used when this vehicle's original overall width cannot be determined.

**CURB WEIGHT**

**Screen Name:** Original Specifications—Curb Weight

**SAS Data Set:** *VEHSPEC*

**SAS Variable:** *CURBWGT*

**Oracle Name:** *VEHICLE.CURBWEIGHT*

**Element Attributes:**

Oracle	SAS	
		Curb weight of vehicle (kgs)
-9999	999999	Unknown

**Range:** 450 – 6,500

**Source:** Researcher determined

**Remarks:**

Enter this vehicle's curb weight.

Do not confuse the rated Gross Vehicle Weight Rating (GVWR) with the curb weight since it is likely to be significantly greater than the curb weight.

"Vehicle" is defined in this variable to mean the same vehicle identified under Body Type.

If the vehicle model is known, but the engine size is unknown (*e.g.*, 6 or 8 cylinders), code the average between the high and low curb weights for the model and annotate that the "average" was reported.

When the vehicle specifications do not report the vehicle weight with the proper engine size, adjustments must be made. First, try to determine the weight differences from the vehicle specifications. If the weight difference cannot be determined from the specifications, then adjust as follows: 8 cyl. to 6 cyl. - subtract 100lb/45 kilograms; 6 cyl. to 4 cyl. - subtract 75lb/34 kilograms.

If a source material reports "shipping weight" add 100lb/45 kilograms to obtain a curb weight on all CDS applicable vehicles.

Towed trailing units are considered cargo weight and not included in the vehicle curb weight.

**Unknown**

is entered when the curb weight of this vehicle cannot be determined.

**AVERAGE TRACK WIDTH**

**Screen Name:** Original Specifications—Average Track

**SAS Data Set:** *VEHSPEC*

**SAS Variable:** *ORIGAVTW*

**Oracle Name:** *VEHICLE.AVGTRACK*

**Element Attributes:**

Oracle	SAS	
		Code to the nearest centimeter
-9999	999	Unknown

**Range:** 100-200, 999

**Source:** Vehicle specifications, undamaged measurements

**Remarks:**

Enter the average track width of the vehicle to the nearest centimeter.

If vehicle specifications cannot be obtained, and there are no post manufacture modifications, and there is no significant damage to the axles, then you can get the value from the case vehicle. Measure both undamaged track widths on the vehicle and record the average.

If an axle is damaged such that an average value cannot be determined, use the measurement of the undamaged axle as the average encoded value.

If both axles are significantly damaged record the value from an exemplar vehicle.

If the vehicle is equipped with dual rear wheels (*i.e.*, some full-size pickup trucks) the track width is measured from the center of the space between the wheels on both sides.

**Unknown**

is used in the following situations:

- The axles are significantly damaged and there are no specifications available for this vehicle, and an exemplar vehicle was not measured.
- The axle is significantly damaged *and* there were post-manufacture modifications that would alter the track width.
- The measurements were not obtained from this vehicle or and exemplar vehicle and there are no specifications available.



**FRONT OVERHANG**

**Screen Name:** Original Specifications—Front Overhang

**SAS Data Set:** *VEHSPEC*

**SAS Variable:** *FTOVHANG*

**Oracle Name:** *VEHICLE.FRONTOVERHANG*

**Element Attributes:**

Oracle	SAS	
		Enter to the nearest centimeter.
-9999	999	Unknown

**Range:** 25-150, 999

**Source:** Vehicle specifications, undamaged measurements or an exemplar vehicle

**Remarks:**

Enter the front overhang, as determined from source materials, of the vehicle to the nearest centimeter.

NOTE: the researcher should record, on the sketch page, the front and rear stringline measurements. These measurements will closely represent the original overhang measurements provided a reference line was established and the axles were not moved.

This measurement is required for all end impacts. If it is a side impact and the front overhang is not available use **Unknown**.

**Unknown**

is used in the following situations:

- The axles are significantly damaged and there are no specifications available for this vehicle, and an exemplar vehicle was not measured.
- The axle is significantly damaged *and* there were post-manufacture modifications that would alter the front overhang.
- The measurements were not obtained from this vehicle or an exemplar vehicle and there are no specifications available.

**REAR OVERHANG**

**Screen Name:** Original Specifications—Rear Overhang

**SAS Data Set:** *VEHSPEC*

**SAS Variable:** *RROVHANG*

**Oracle Name:** *VEHICLE.REAROVERHANG*

**Element Attributes:**

Oracle	SAS	
		Enter to the nearest centimeter.
-9999	999	Unknown

**Range:** 25-200, 999

**Source:** Vehicle specifications, undamaged measurements or an exemplar vehicle.

**Remarks:**

Enter the rear overhang, as determined from source materials, of the vehicle to the nearest centimeter.

NOTE: the researcher should record, on the sketch page, the front and rear stringline measurements. These measurements will closely represent the original overhang measurements provided a reference line was established and the axles were not moved.

**Unknown**

is used in the following situations:

- The axles are significantly damaged and there are no specifications available for this vehicle, and an exemplar vehicle was not measured.
- The axle is significantly damaged *and* there were post-manufacture modifications that would alter the rear overhang.
- The measurements were not obtained from this vehicle or an exemplar vehicle and there are no specifications available.

**UNDEFORMED END WIDTH**

**Screen Name:** Original Specifications—Undeformed End Width

**SAS Data Set:** *VEHSPEC*

**SAS Variable:** *UNENDW*

**Oracle Name:** *VEHICLE.ENDWIDTH*

**Element Attributes:**

Oracle	SAS	
		Enter to the nearest centimeter.
-9999	999	Unknown

**Range:** 100-250, 999

**Source:** Vehicle inspection, or an of an exemplar vehicle

**Remarks:**

The undeformed end width is the undamaged dimension of the contacted end plane measured between the apex of both bumper corners.

**Unknown**

If the vehicle cannot be directly measured and an exemplar vehicle cannot be found, then enter unknown.

**ENGINE CYLINDERS**

**Screen Name:** Original Specifications—Engine Cylinders

**SAS Data Set:** *VEHSPEC*

**SAS Variable:** *ENGCYL*

**Oracle Name:** *VEHICLE.CYLINDERS*

**Element Attributes:**

Oracle	SAS	
		Code the number of cylinders
		Not Applicable
-9999	99	Unknown

**Range:** 1-14, 99

**Source:** Vehicle inspection, specifications, VIN

**Remarks:**

The coding of this variable reflects the number of cylinders in the vehicle. The information can be found in vehicle specifications. It may also be found in owner’s manuals.

**Not Applicable**

is used for vehicles that do not have a combustible engine, an example is an all electric vehicle.

**Unknown**

If the number of engine cylinders cannot be determined, then enter unknown.

**ENGINE DISPLACEMENT**

**Screen Name:** Original Specifications—Engine Displacement

**SAS Data Set:** *VEHSPEC*

**SAS Variable:** *ENGDISP*

**Oracle Name:** *VEHICLE.ENGINEL*

**Element Attributes:**

Oracle	SAS	
		Code to the nearest tenth of a liter
		Not Applicable
-9999	99	Unknown

**Range:** 0.0-10.0, 99

**Source:** Vehicle inspection, specifications, VIN

**Remarks:**

The coding of this variable reflects the vehicle’s engine displacement. The information can be found in vehicle specifications. It may also be found in owner’s manuals, or from the vehicle inspection.

Enter the vehicle’s engine displacement. It is recorded to the nearest tenth of a liter.

**Not Applicable**

is used for vehicles that do not have a combustible engine, an example is an all electric vehicle.

**Unknown**

If the displacement cannot be determined, then enter unknown.

**TYPE OF TRANSMISSION**

**Screen Name:** Type of Transmission

**SAS Data Set:** *VEHSPEC*

**SAS Variable:** *TRANS*

**Oracle Name:** *VEHICLE.PICKTRANSMISSIONCODE*

**Element Attributes:**

Oracle	SAS	
1	1	Manual
2	2	Automatic
3	9	Unknown

**Source:** Vehicle inspection

**Remarks:**

The coding of this variable reflects the type of transmission that is in the vehicle.  
This variable is being collected for use in modifying input to the WINSMASH computer program.

**Manual**

The vehicle has a manual transmission.

**Automatic**

The vehicle has an automatic transmission.

**Unknown**

It cannot be determined what type of transmission is in the vehicle.

**DRIVE WHEELS**

**Screen Name:** Drive Wheels

**SAS Data Set:** *VEHSPEC*

**SAS Variable:** *DRIVE*

**Oracle Name:** *VEHICLE.PICKDRIVEWHEELSCODE*

**Element Attributes:**

Oracle	SAS	
1	1	Front Wheel Drive
2	2	Rear Wheel Drive
3	3	Four Wheel Drive
4	4	All Wheel Drive
5	9	Unknown

**Source:** Vehicle inspection

**Remarks:**

The coding of this variable reflects the type of drive wheels power the vehicle.  
This variable is being collected for use in modifying input to the WINSMASH computer program.

**Front Wheel Drive**

In a front-wheel drive vehicle, power from the engine is transferred to the front tires.

**Rear Wheel Drive**

In a rear-wheel drive vehicle, power from the engine is transferred to the rear tires.

**4 Wheel Drive**

In a four-wheel drive vehicle, power is delivered to all four wheels only when the driver requests it.

**All Wheel Drive**

In an all-wheel drive vehicle, power is distributed to all four of the vehicle's tires, all of the time.

**Unknown**

Use this when it cannot be determined what type of drive wheels power the vehicle.

## MULTI-STAGE OR ALTERED VEHICLE

Page 1 of 3

**Screen Name:** Is This a Multi-Stage Manufactured Vehicle And/Or A Certified Altered Vehicle?

**SAS Data Set:** *VEHSPEC*

**SAS Variable:** *ALTVEH*

**Oracle Name:** *VEHICLE.MANUFACTURERCERTMODS*

**Element Attributes:**

Oracle	SAS	
1	0	No post manufacturer modifications
2	1	Yes — post manufacturer modifications (specify)
9	9	Unknown if vehicle is modified
-8		[Not inspected]

**Source:** Vehicle Inspection.

**Remarks:**

Under the "Code of Federal Regulations, Title 49 - Transportation" Chapter V Part 567, Sections 567.5 and 567.7, a label certifying compliance with all Federal Motor Vehicle Safety Standards must be affixed to a multi-stage manufactured vehicle or altered (post manufactured) vehicle.

A multi-stage manufactured vehicle will generally begin as a chassis-cab (incomplete vehicle) and subsequently end up in final-stage as a pickup based utility truck (dump truck, flat bed, stake body, tow truck, etc.) or a van derivative (*i.e.*, van conversion, Hi-cube, motor home, etc.).

Altered vehicles will generally involve a major modification of basic components such as suspension, frame, power plants, etc., with work generally performed by a recognized auto body shop. The lengthening of a standard automobile chassis to create a limousine would be one example of the type of alteration which would qualify for certification.

To determine if the vehicle qualifies, locate the certification label which should include one of the following statements:

***Multi-stage vehicle***

Incomplete manufactured vehicle (chassis-cab) certification label should include the statement: "**CHASSIS-CAB MANUFACTURED BY**" or "**CHASSIS-CAB MFD. BY**".

Intermediate manufactured vehicle certification label should have the following statement: "**INTERMEDIATE MANUFACTURED BY**" or "**INTERMEDIATE MFD. BY**".



Multi-Stage or Altered Vehicle (cont'd)

Page 2 of 3

Final manufactured vehicle certification label should have the following statements:

**"MANUFACTURED BY" or "MFD. BY" and "INCOMPLETE VEHICLE MANUFACTURED BY" or "INC VEH MFD. BY".**

***Altered vehicle***

An altered vehicle certification label should include the statement: **"This vehicle was altered by (individual or corporate name) in (month and year in which alterations were completed) and as altered it conforms to all applicable Federal Motor Vehicle Safety Standards affected by the alteration and in effect in (month, year)."**

These labels are generally affixed in one of the following areas on the driver's side of the vehicle:

- hinge pillar
- door-latch post
- door edge that meets the door-latch post
- left side of the instrument panel
- inward-facing surface of driver's door

**No post manufacturer modifications**

is used when this vehicle was a full-line manufactured vehicle. Full-line is interpreted as a vehicle that is completely assembled at the end of a plant assembly line of its original manufacturer. This would include vehicles which only require cosmetic additions such as additional paint, mirrors, wheels, etc., to be customer ready.

**Yes — post manufacturer modifications**

is used for multi-stage vehicles and/or altered certified vehicles. This includes vehicles which were in various stages of completion (*i.e.*, incomplete, intermediate, final).

Vehicles that are altered via "backyard modification (*i.e.*, addition of air shocks, spring spacers, cosmetic alteration including sheet metal and paint, etc.) are not identified as certified altered vehicles. Only those businesses which specialize in vehicle alterations (*i.e.*, limo body shops, etc.) where a label of alteration is required by federal regulations and is present on the vehicle are identified in this element.

***An image of the certification label(s) is essential and must be included with the case. Categorize this image in the Miscellaneous Category.***

**Unknown**

is used in the following situations.

- The vehicle fits the description of a multi-stage or altered vehicle, but the researcher was not able to view the label(s) for positive identification.
- The label(s) was removed/destroyed so a clear determination of whether the vehicle was a certified multi-stage or altered vehicle could not be made.

Multi-Stage or Altered Vehicle (cont'd)

Photograph examples:

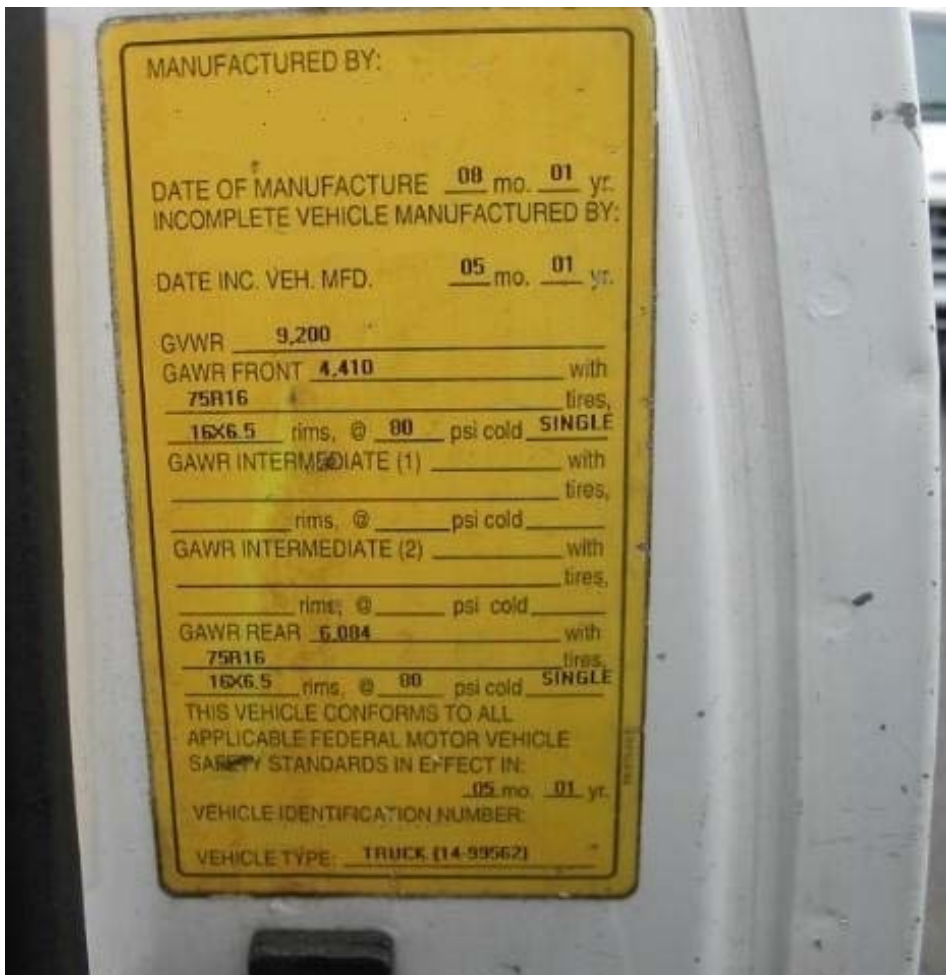
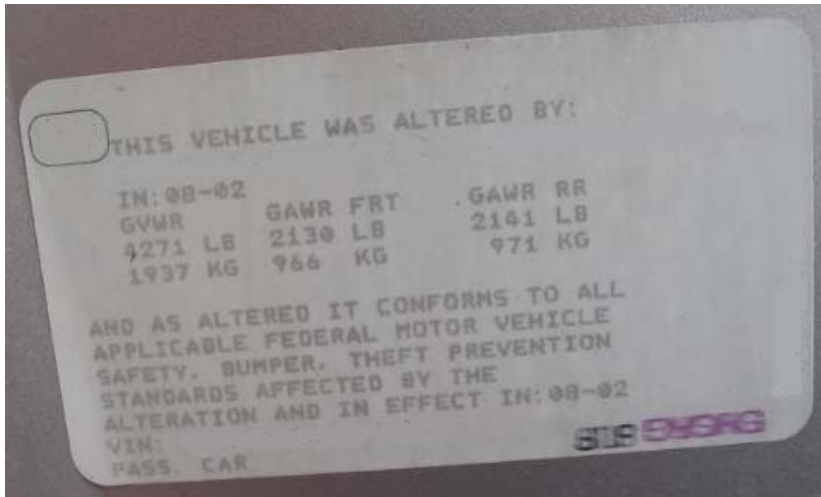

**SUSPECTED POST MANUFACTURER MODIFICATIONS**

**Screen Name:** Suspected post manufacturer modifications

**SAS Data Set:**

**SAS Variable:**

**Oracle Name:** *VEHICLE.SUSPECTEDMODS*

**Element Attributes:**

Check Box

**Range:**

**Source:** Vehicle inspection, researcher determined

**Remarks:**

The purpose of this variable is to determine if the vehicle has been modified so that the handling and crashworthiness characteristics are affected. This is based upon a suspicion by the researcher at the time of the vehicle inspection.

Examples of modifications:

- Smaller or larger tires
- Body lift kit
- Lowered body
- Altered suspension
- Composite front body panels

Examples of modifications that are not considered:

- Changing the side rear view mirrors
- Aftermarket window tinting
- Additional lighting attached to the roof

**FUEL SYSTEMS**

Be sure to photograph all fuel tanks and surrounding area. Refer to the [NASS CDS Digital Photography Guideline](#) for a detailed description of the required photographs.

Record **all** fuel systems, and code any Damage to Fuel Cell. If Fuel Cell is damaged other variables are required to be coded.

Exterior Vehicle Form, Case 2007-996-900015/ Vehicle #1

VEHICLE | TIRE | SPECIFICATIONS | FUEL | FIRE | CRUSH | CDC | EDR | SKETCHES | LOG | REVIEW

Fuel System Number 1 of 2 Previous Next

Fuel Type: Nickel-Cadmium Battery

Damage to Fuel Cell: No damage to cell

Leakage Location: No fuel leakage

Location of Fuel Cell: Over the rear axle

Type of Fuel Cell: Electric/solar powered

Location of Filler Cap: Electric/solar powered

Precrash Condition: No damage

Save Close

**Note:** Code Fuel Type, Damage to Fuel Cell, and Leakage Location for each Fuel System noted. Code other variables only if a leak, damage or fire occurred

**FUEL SYSTEM NUMBER**

**Screen Name:** Fuel System Number

**SAS Data Set:** *FUELTANK*

**SAS Variable:** *TANKNO*

**Oracle Name:** *FUELTANK.FUELTANKNUMBER*

**Element Attributes:**

Number of fuel cell

**Remarks:**

Use Edit/Insert to add a fuel system for **each** fuel system in the vehicle.

This variable records those fuel systems that are permanently affixed to the vehicle as an energy reservoir for the vehicle's engine. Some vehicles may be equipped with reserve cells. (i.e., one or more cells connected in series and controlled by the driver).

Extra fuel cells on-board a vehicle which are not designed to supply fuel to the vehicle's engine are not considered for this variable. Some examples include: fuel cans, bottled gas, and ancillary tanks for occupational related work (i.e., construction, etc.).

An electric fuel cell, hydrogen fuel cell or compressed natural gas (CNG) is considered a fuel system.

**FUEL TYPE**

Page 1 of 3

**Screen Name:** Fuel Type**SAS Data Set:** *FUELTANK***SAS Variable:** *FUELTYF***Oracle Name:** *FUELTANK.PICKFUELTYPE***Element Attributes:**

Oracle	SAS	
1	1	Gasoline
17	17	Gasoline/Ethanol (E85)
18	18	Gasoline/Methanol (M85)
2	2	Diesel
3	3	CNG (Compressed Natural Gas)
4	4	LPG (Liquid Petroleum Gas) also known as Propane
5	5	LNG (Liquid Natural Gas)
19	7	Ethanol (E100)
20	6	Methanol (M100)
21	16	Lithium-ion Battery
12	12	Nickel-Cadmium Battery
16	15	Nickel-Metal Hydride (NiMH)
9	9	Hydrogen Fuel Cell
98	98	Other (specify):
99	99	Unknown fuel type

**Source:** Primary source is the vehicle inspection; secondary source is the interviewee(s).**Remarks:**

These variables record the fuel type available in each fuel system during this crash sequence. The type of fuel the engine was operating on will normally be indicated on the vehicle. Typical locations include, but are limited to fuel door, filler cap, fuel gauge and vehicle owner's manual.

**Gasoline**

is described as a volatile mixture of flammable liquid hydrocarbons derived from crude oil and used principally as a fuel for internal-combustion engines. Use this attribute for gasoline and ethanol mixture. This is commonly called "gasohol" which is a mixture of gasoline and ethanol (10%) or methanol (3%).

**Gasoline/Ethanol (E85)**

is described as a mixture of 85 percent ethanol and 15 percent of unleaded gasoline. This vehicle can operate on 100% gasoline or E85. This fuel type is used in flexible fuel vehicles (FFVs).

**Gasoline/Methanol (M85)**

is described as a mixture of 85 percent methanol and 15 percent of premium unleaded gasoline. This vehicle can operate on 100% gasoline or M85.

**Diesel**

is described as a volatile mixture of flammable liquid hydrocarbons derived from crude oil and used principally as a fuel for internal-combustion engines. It has the same process as gasoline but not as refined. This attribute includes bio-diesel fuel.

**Compressed Natural Gas (CNG)**

Compressed natural gas, or CNG, is natural gas under pressure which remains clear, odorless, and non-corrosive. Although vehicles can use natural gas as either a liquid or a gas, most vehicles use the gaseous form compressed to pressures above 3,100 pounds per square inch.

**LPG (Liquid Petroleum Gas) also known as Propane**

Motor Fuel Propane, otherwise known as Liquefied Petroleum Gas (LPG), is produced as part of natural gas processing and crude oil refining. In natural gas processing, the heavier hydrocarbons that naturally accompany natural gas, such as LPG. Propane is a gas that can be turned into a liquid at a moderate pressure, 160 pounds per square inch (psi), and is stored in pressure tanks at about 200 psi at 100 degrees Fahrenheit.

**LNG (Liquid Natural Gas)**

Liquefied natural gas, or LNG, is natural gas in a liquid form that is clear, colorless, odorless, non-corrosive, and non-toxic. LNG is produced when natural gas is cooled to minus 259 degrees Fahrenheit, through a process known as liquefaction. During this process, the natural gas, which is primarily methane, is cooled below its boiling point, whereby certain concentrations of hydrocarbons, water, carbon dioxide, oxygen, and some sulfur compounds are either reduced or removed. LNG is also less than half the weight of water, so it will float if spilled on water.

**Ethanol (E100)**

is described as a fuel that is produced by fermenting a biomass (corn), commonly called grain alcohol.

**Methanol (M100)**

Methanol (methyl alcohol), is described as a fuel type made from natural gas. Thus fuel is commonly referred to as "neat" 100% methonal.

Fuel Type (cont'd)

Page 3 of 3

**Lithium-ion Battery**

is a family of rechargeable battery types in which lithium ions move from the negative electrode to the positive electrode during discharge, and back when charging. Commonly referred to Li-ion battery or LIB.

**Nickel-Cadmium Battery**

described as a sealed storage battery having a nickel anode, a cadmium cathode and an alkaline electrolyte. Commonly referred to as NiCd.

**Nickel-Metal Hydride**

described as similar to the nickel-cadmium battery but containing less toxic material and has a higher capacity. Commonly referred to as NiMH.

**Hydrogen Fuel Cell**

Hydrogen is the simplest, lightest and most plentiful element in the universe. It is made up of one proton and one electron revolving around the proton. In its normal gaseous state, hydrogen is colorless, odorless, tasteless, non-toxic and burns invisibly. Fuel cells generate electricity from a catalyst-facilitated chemical reaction between hydrogen and oxygen ions in a cell. Several cells combined makeup a fuel cell stack. Fuel cell systems have relatively few moving parts, and their only by products are water and heat when pure hydrogen is used as the fuel.

**Other (specify)**

is used for any type of fuel used that is not described in the above attributes. This includes alternative energy sources, i.e., flywheel technology. Included in this attribute are the following battery types: Lead acid, Nickel Iron, Sodium Metal Chloride, and Sodium Sulfur. Annotate for specific information.

**Unknown fuel type**

is used when:

- The vehicle was totally destroyed, or
- The fuel type can not be determined



**DAMAGE TO FUEL CELL**

**Screen Name:** Damage to Fuel Cell

**SAS Data Set:** *FUELTANK*

**SAS Variable:** *FUELDAM*

**Oracle Name:** *FUELTANK.PICKDAMAGEDFUELTANK*

**Element Attributes:**

Oracle	SAS	
1	1	No damage to cell
2	2	Deformed, no seam separation
3	3	Deformed, with a seam separation
4	4	Punctured
5	5	Lacerated (ripped)
6	6	Abraded (scraped)
7	7	Filler neck separation from the fuel cell
8	8	Other damage (specify):
9	9	Unknown

**Source:** Vehicle Inspection.

**Remarks:**

These variables record the damage to the fuel cell(s) that occurred during the sequence of crash events. The objective of these variables is to identify damage to the fuel cell(s) that may or may not result in a loss of fuel system integrity. If the fuel cell(s) has more than one form of damage, enter the damage that resulted in a fuel system integrity loss. If there were multiple types of integrity loss then select the first attribute which applies

Refer to the [NASS CDS Digital Photography Guideline](#) for a detailed description of the required photographs.

In addition, annotate any precrash damage to the fuel tank.

**No damage to fuel cell**

is used when the fuel cell is not damaged during the sequence of crash events.

**Deformed, no seam separation**

is used when the fuel cell was deformed or crushed during the crash and the seam did not fail. Tanks which do not have a seam(s) (*e.g.*, extruded fuel cells such as high density polyethylene HDPE) should be evaluated for deformation and encoded under this attribute if applicable.

**Deformed, with a seam separation**

is used when the fuel cell was deformed or crushed during the crash and the seam failed. Single piece extruded cells (*i.e.* no seams, HDPE) which experience integrity loss are **not** entered here.

**Punctured**

is used when the fuel cell was punctured, perforated or pierced during the collision sequence.

**Lacerated (ripped)**

is used when the fuel cell was lacerated, cut, sliced, ripped or torn during the collision sequence.

**Abraded (scraped)**

is used when the fuel cell was abraded or scraped during the collision sequence.

**Filler neck separation from the fuel tank**

is used when the filler neck was separated from the fuel cell during the collision sequence.

**Other damage (specify)**

is used when damage to the fuel cell can not be described in other attributes. HDPE cells that are crushed to the point that they crack, causing an integrity loss of the fuel cell, are included here.

**Unknown**

is used when the fuel cell damage can not be determined.

**FUEL SYSTEM LEAKAGE LOCATION**

**Screen Name:** Leakage Location

**SAS Data Set:** *FUELTANK*

**SAS Variable:** *FUELLEAK*

**Oracle Name:** *FUELTANK.PICKLEAKAGEAREA*

**Element Attributes:**

Oracle	SAS	
1	1	No fuel leakage

**Primary Area Of Leakage**

2	2	Cell
3	3	Filler neck
4	4	Cap
5	5	Lines/pump/filter
6	6	Vent/emission recovery
7	8	Other (specify):
8	9	Unknown
		[Not Applicable]

**Source:** Vehicle Inspection.

**Remarks:**

These variables provide information on fuel retention by the fuel system during the crash sequence. The objective of these variables is to report fuel system leakage. If the fuel system has leakage from more than one source, enter the leakage that resulted in a fire. If there are multiple areas of leakage and no fire, then enter the most severe area of leakage. If the severity can not be determined, then use attributes in the priority listed.

Refer to the [NASS CDS Digital Photography Guideline](#) for a detailed description of the required photographs.

If no fuel leakage was caused by the crash, record no fuel leakage. If the fuel system was leaking prior to the collision, (*i.e.*, corrosion to tank, loose fuel line, etc.) annotate the information. In this variable leakage can only occur from impact damage.

**No fuel leakage**

is used when there has been no loss in fuel retention.

**Cell**

is used when the fuel cell was leaking as a result of an impact during the crash sequence. Also use this attribute when leakage occurs as a result of all the filler neck separating from the fuel cell.

**Filler Neck**

is used when the filler neck is the source of fuel leakage as a result of an impact during the crash sequence.

**Cap**

is used when the mouth of the filler neck or the filler cap is the source of fuel leakage that occurred as a result of damage from an impact during this vehicle's crash sequence.

**Lines/pump/filter**

is used when fuel was leaking from the fuel system lines, pump and/or fuel filter as a result of an impact during the crash sequence.

**Vent/emission recovery**

is used when fuel was leaking from the vent or emission recovery system as a result of an impact during the crash sequence.

**Other (specify)**

is used when fuel was leaking, as a result of the crash, from other than the sources specified above.

**Unknown**

is used when:

- It cannot be determined if the fuel system experienced any leakage, or
- The source of the fuel system leakage could not be determined.

## LOCATION OF FUEL CELL

Page 1 of 2

Screen Name: Location of Fuel Tank

SAS Data Set: **FUELTANK**SAS Variable: **FUELLOC**Oracle Name: **FUELTANK.PICKLOCATIONOFTANK****Element Attributes:**

Oracle	SAS	
1	1	Aft of rear axle centered
2	2	Aft of rear axle left side
3	3	Aft of rear axle right side
4	4	Forward of rear axle centered
5	5	Forward of rear axle left side
6	6	Forward of rear axle right side
7	7	Over the rear axle
8	8	Other (specify):
9	9	Unknown
-8887		[Not Applicable]

Source: Vehicle Inspection.

**Remarks:**

This variable identifies the location(s) of this vehicle's fuel cell(s). Refer to the [NASS CDS Digital Photography Guideline](#) for a detailed description of the required photographs.

**Aft of rear axle centered**

is used to identify fuel cells located in back of the center of the rear wheels (rear axle) and in the center of the vehicle (*e.g.*, between the frame rails if present).

**Aft of rear axle left side**

is used to identify fuel cells located in back of the center of the rear wheels (rear axle) and on the left side of the vehicle (*e.g.*, between the frame rails and the outer body surface).

**Aft of rear axle right side**

is used to identify fuel cells located in back of the center of the rear wheels (rear axle) and on the right side of the vehicle (*e.g.*, between the frame rails and the outer body surface).

**Forward of center of the rear wheels (rear axle) centered**

is used to identify fuel cells located in front of the center of the rear wheels (rear axle) and in the center of the vehicle (*e.g.*, between the frame rails if present).

**Forward of center of the rear wheels (rear axle) left side**

is used to identify fuel cells located in front of the center of the rear wheels (rear axle) and in the left side of the vehicle (*e.g.*, between the frame rails and the outer body surface).

**Forward of center of the rear wheels (rear axle) right side**

is used to identify fuel cells located in front of the center of the rear wheels (rear axle) and in the right side of the vehicle (*e.g.*, between the frame rails and the outer body surface).

**Over the rear axle**

is used when any part of the fuel cell is located over the center of the rear wheels (rear axle)

**Other (specify)**

is used when the fuel cell is in a location other than as specified in the previous attributes. Included in this attribute are fuel cells located inside the passenger compartment, trunk, cargo area, pickup bed, etc. The location is specified in the space provided.

**Unknown**

is used when the fuel cell location can not be determined and an exemplar vehicle can not be located.

**TYPE OF FUEL CELL**

**Screen Name:** Type of Fuel Tank

**SAS Data Set:** *FUELTANK*

**SAS Variable:** *FUELTNK*

**Oracle Name:** *FUELTANK.PICKTYPEOFTANK*

**Element Attributes:**

Oracle	SAS	
1	1	Metallic
2	2	Non-Metallic
3	9	Unknown
0		[Electric/solar powered]
-8887		[Not Applicable]

**Source:** Vehicle Inspection.

**Remarks:**

This variable records the composition of the fuel cell that is permanently affixed to the vehicle as an energy reservoir for the vehicle's engine.

**Metallic**

is used for fuel cells made from metal. This would include steel, aluminum (alloys), stainless steel, etc.

**Non-metallic**

is used for fuel tanks which are made from plastic. Plastic tanks are composed of high density polyethylene (HDPE).

**Unknown**

is used when the type of tank material could not be determined:

- researcher could not make a determination due to inaccessibility, or
- vehicle was dismantled during inspection and the fuel tank(s) was not available.

The following information has been compiled from discussions with automobile manufacturers, service and parts representatives and the National Automotive History Collection. This information cannot be used to code this variable and must be confirmed by visual and/or mechanical means.

**Vehicle Fuel Tank Material****HDPE (High Density Polyethylene)****(1) Ford Motor Co.**

Ford Aerostar Mini Van	HDPE
Ranger PU (89-on)	HDPE
Explorer	HDPE
Cougar/T-Bird (90-on)	Some have HDPE with steel reinforcement
F Series PU	Some of the earlier models may have HDPE
Escort (91-on)	Some have HDPE
Tracer (91-on)	Some have HDPE
Mustang (93-on)	Some have HDPE

**(2) General Motors Corp.**

## Chevrolet

Lumina Mini Van	HDPE
"B" Body (91-on)	HDPE
- Caprice	
- Impala	
- Station Wagons	
"L" Body (91-on)	HDPE
- Corsica	
- Beretta	

## Pontiac

Tran Sport Mini Van	HDPE
Parisienne	HDPE

## Oldsmobile

Silhouette Mini Van	HDPE
Custom Cruiser	HDPE

## Buick

LeSabre Estate (90-on)	HDPE
Roadmaster	HDPE

## Saturn

HDPE - all models



Type of Fuel Tank (cont'd)

- (3) **Chrysler Corp.**
  - Plymouth
    - Voyager Wagon HDPE in optional 20 gallon tank
    - Trailduster (80-on) HDPE
  - Dodge
    - Caravan Wagon HDPE in optional 20 gallon tank
  - Sportsman(1980) Optional tank was HDPE
    - (88-on) HDPE
  - Ram Wagon(1980) Optional tank was HDPE
    - (88-on) HDPE
  - Tradesman(1980) Optional tank was HDPE
    - (88-on) HDPE
  - Ram Van(1980) Optional tank was HDPE
    - (88-on) HDPE
  - Ram PU(80-on) HDPE
  - Power Ram PU(80-on) HDPE
  - Ramcharger(80-on) HDPE
  - Dakota(86-on) HDPE
  - Monaco HDPE
- Eagle
  - Premier(88-on) HDPE
- Jeep
  - CJ5 (83-91) Optional tank was HDPE
  - CJ7 (81-86) Optional tank was HDPE
  - CJ8 (81-86)/Scrambler Optional tank was HDPE
  - Wrangler (87-on) Optional tank (22 gal) was HDPE
  - Cherokee (80-on) HDPE-some have steel tanks
  - Wagoneer (80-on) HDPE
  - J10, J20 PU (80-on) HDPE
  - Grand Wagoneer (84-on) HDPE
- (4) **Peugeot**
  - 505 HDPE
  - Station Wagon HDPE
  - Sedan HDPE

Type of Fuel Tank (cont'd)

Page 4 of 4

- |     |   |                              |
|-----|---|------------------------------|
| (5) | <b><i>Volkswagen</i></b><br>Golf (85-86, 89-on)<br>Jetta (90-on)<br>Passat (92-on)<br>Corrado (89-on) | HDPE<br>HDPE<br>HDPE<br>HDPE |
| (6) | <b><i>Volvo</i></b><br>700 Series (85-on)   | HDPE                         |
| (7) | <b><i>Saab</i></b><br>All Models (80-on)  | HDPE                         |
| (8) | <b><i>Merkur</i></b><br>Scorpio<br><br>XR4Ti  | HDPE<br><br>Some are HDPE    |
| (9) | <b><i>Mitsubishi</i></b>  | Trucks only are HDPE         |

**All Vehicles from the Following Manufacturers Have Steel Gas Tanks**

Acura	Infiniti	Porsche
Alfa Romeo	Isuzu	Renault
Bentley	Lexus	Sterling
BMW	Lincoln	Subaru
Cadillac	Lotus	Suzuki
Geo	Mazda	Toyota
Honda	Mercedes Benz	Yugo
Hyundai	Nissan	

**LOCATION OF FILLER CAP**

**Screen Name:** Location of Filler Cap

**SAS Data Set:** *FUELTANK*

**SAS Variable:** *FUELCAP*

**Oracle Name:** *FUELTANK.PICKLOCATIONOFFILLERCAP*

**Element Attributes:**

Oracle	SAS	
1	1	On back plane
6	2	Over the rear axle on left side plane
7	3	Over the rear axle on right side plane
2	4	Aft of rear axle on left side plane
3	5	Aft of rear axle on right side plane
4	6	Forward of rear axle on left side plane
5	7	Forward of rear axle on right side plane
8	8	Other (specify):
9	9	Unknown
0		[Electric/solar powered]
-8887		[Not Applicable]

**Source:** Vehicle Inspection, secondary source exemplar vehicle

**Remarks:**

These variables identify the location(s) of the fuel tank filler cap in its original undamaged position on the vehicle.

Be sure to photograph the tank and surrounding area. Refer to the [NASS CDS Digital Photography Guideline](#) for a detailed description of the required photographs.

**On back plane**

is used when the fuel tank filler cap is located on the back plane of the vehicle.

**Over the rear axle on left side plane**

is used when any part of the fuel tank filler cap is located over the center of the rear wheels (rear axle) on the left side plane. This attribute takes precedence over the following attributes.

**Over the rear axle on right side plane**

is used when any part of the fuel tank filler cap is located over the center of the rear wheels (rear axle) on the right side plane. This attribute takes precedence over the following attributes.

**Aft of rear axle on left side plane**

is used when the fuel tank filler cap is located behind the center of the rear wheels (rear axle) and on the left side plane of the vehicle.

**Aft of rear axle on right side plane**

is used when the fuel tank filler cap is located behind the center of the rear wheels (rear axle) and on the right side plane of the vehicle.

**Forward of rear axle on left side plane**

is used when the fuel tank filler cap is located in front of the center of the rear wheels (rear axle) on the left side plane of the vehicle.

**Forward of rear axle on right side plane**

is used when the fuel tank filler cap is located in front of the center of the rear wheel(s) (rear axle) on the right side plane of the vehicle.

**Other (specify)**

is used when the fuel tank filler cap is in a location other than as specified above. The location is specified in the space provided.

**Unknown**

is used when the fuel tank filler cap location can not be determined and an exemplar vehicle can not be located (e.g., the vehicle was totally destroyed).

**PRECRASH CONDITION OF FUEL CELL**

**Screen Name:** Precrash Condition

**SAS Data Set:** *FUELTANK*

**SAS Variable:** *FUELPRE*

**Oracle Name:** *FUELTANK.PICKPRECRASHCONDITION*

**Element Attributes:**

Oracle	SAS	
0	0	Electric/solar powered
1	1	No damage
2	2	Corroded
3	3	Leaking
4	4	Abraded
5	8	Other (specify):
6	9	Unknown
-8887		[Not Applicable]

**Source:** Vehicle Inspection, secondary source is the interview

**Remarks:**

These variables record the damage to the fuel tank(s) that was present prior to the crash. The objective of these variables is to identify damage to the fuel tank(s) that was not a result of the crash. When more than one damage is present select the choice that is higher on the list.

**No damage**

is used when the fuel tank was not damaged prior to the crash

**Corroded**

is used when corrosion damage is evident on the fuel tank.

**Leaking**

is used when there is evidence of leakage present and it can be determined that it is not a result of the collision sequence of events.

**Abraded**

is used when there is evidence of abrasion or scraping on the fuel tank not a result of the crash.

**Other (specify)**

is used to indicate other damage not listed above.

Precrash Condition of Fuel Cell (cont'd)

Page 2 of 2

**Unknown**

is used when the precrash condition of the fuel tank cannot be determined

FIRE

Exterior Vehicle Form, Case 2007-996-900015/ Vehicle #1

VEHICLE | TIRE | SPECIFICATIONS | FUEL | FIRE | CRUSH | CDC | EDR | SKETCHES | LOG | REVIEW

Fire Occurrence

Origin of Fire

Save Close

**FIRE OCCURRENCE**

**Screen Name:** Fire Occurrence

**SAS Data Set:** *GV*

**SAS Variable:** *FIRE*

**Oracle Name:** *FIRE.PICKSEVERITYCODE*

**Element Attributes:**

Oracle	SAS	
1	0	No fire
2	1	Minor fire
3	2	Major fire
	7	Vehicle not inspected
	8	[Not a CDS vehicle]
9	9	Unknown

**Source:** Primary source is the vehicle inspection; secondary sources include the interviewee(s), police report, and occupant medical records.

**Remarks:**

Fire events are added on the Case Form/Events Tab.

In order to classify fire damage, a fire must have occurred to this vehicle. (1) The fire could have resulted from an impact with another vehicle or object which consequently caused a fuel system integrity failure or electrical short circuit. (2) If the fire resulted from a noncollision event (*e.g.*, electrical short circuit, fuel leakage, etc.) that occurred prior to this vehicle impacting with another vehicle or object, and if the crash qualifies for the NASS CDS, then both the noncollision event and all subsequent events are entered on the Case Form Events Tab.

**As it pertains to the occurrence of fire**, the crash circumstances are not considered stabilized until the threat of damage to this vehicle, or injury consequences to this vehicle's occupants, has ceased. Therefore, the crash sequence is not considered stabilized until all occupants have exited the vehicle and the scene has been declared safe by police or other authority. Fires that occur at a later time to vehicles abandoned at the scene (*e.g.*, in open fields, on hillsides, etc) or to vehicles removed from the scene to another location (towyard, curbside, etc.) are not considered part of the crash sequence.

**Minor**

is a general term used to describe the degree of fire involvement and is used in the following situations:

- Engine compartment only fire



- Trunk compartment only fire
- Partial passenger compartment only fire
- Undercarriage only fire
- Tire(s) only fire

**Major**

identifies those situations where the vehicle experienced a greater fire involvement than defined under “minor” above and is used in the following situations:

- Combined engine and passenger compartment fire (either partial or total passenger compartment involvement).
- Total passenger compartment fire.
- Combined trunk and passenger compartment fire (either partial or total passenger compartment involvement).
- Combined undercarriage and passenger compartment (either partial or total passenger compartment involvement).
- Combined tire(s) and passenger compartment (either partial or total passenger compartment involvement).

**Unknown**

is used when it cannot be determined if this vehicle sustained a fire related to the crash, e.g., a fire was reported, but this vehicle was repaired prior to inspection.

**ORIGIN OF FIRE**

Page 1 of 3

**Screen Name:** Origin of Fire**SAS Data Set:** *GV***SAS Variable:** *FIREORIG***Oracle Name:** *FIRE.PICKFIREORIGIN***Element Attributes:**

Oracle	SAS	
	0	No fire
1	1	Vehicle exterior (front, side, back, top)
2	2	Exhaust system
3	3	Fuel tank (and other fuel retention system parts)
4	4	Engine compartment
5	5	Cargo/trunk compartment
6	6	Instrument panel
7	7	Passenger compartment area
8	8	Other location (specify):
	77	[Vehicle not inspected]
	88	[Not a CDS vehicle]
9	99	Unknown

**Source:** Primary source is the vehicle inspection; secondary sources include the interviewee(s), and police report.

**Remarks:**

This variable identifies the location of fire initiation and should not be confused with the magnitude of the fire. As an example, if the vehicle appeared totally "burned", Passenger compartment area would not necessarily be used unless the fire began in the vehicle's interior.

For many fires it will be difficult to determine fire origin especially when the entire vehicle was involved. The researcher should look for "hot" spots which generally appear lighter in coloration and are often accompanied by warped or melted metal. If multiple fires occur to the same vehicle, choose the fire that started within this vehicle (*i.e.*, choose an interior fire over an exterior fire), then choose the fire with the greater severity.

**Vehicle exterior (front, side, back, top)**

identifies fire source as occurring external to the vehicle. This generally occurs in a multiple vehicle collision where another vehicle initiates the fire and the fire is then introduced to this vehicle.

**Exhaust system**

is used when components of the exhaust system initiated the fire. Components of the exhaust system include: exhaust pipes, muffler/resonator, and catalytic converter.

**Fuel tank (and other fuel retention system parts)**

includes: the fuel tank(s), fuel supply and vent lines, tank filler neck, and fuel filler cap. Use this attribute when the fuel tank area (defined above) sustains damage such that fuel leaks and is ignited by sparks from contact with the surface of crushing metal components, or is ignited by hot surfaces of the vehicle or object that is involved in producing the damage (*e.g.*, lamp filaments, hot engine components of an impacting vehicle).

Do not use this if fuel leakage occurs and is ignited in this vehicle's engine compartment [*i.e.*, use Engine compartment]. If fuel leakage occurs in the fuel tank area and spills onto and is ignited by hot exhaust system components, then use Exhaust system.

**Engine compartment**

is used when the fire initiates in the area (open or enclosed) which houses the engine. Generally, most engine compartments are located at the front end of the vehicle under the hood. However, some engines are mounted midway (referred to as mid- engine) on the chassis, and some are located at the rear of the vehicle.

The reason for fire initiation in these areas is inconsequential (whether fuel or electrical), but the fire's relative location to the engine is the important consideration.

**Cargo/trunk compartment**

identifies areas which are separated from the passenger compartment by a solid partition. In passenger automobiles, the partition will generally be formed by the seat back(s), package shelf, and trunk lid. However, areas designed to accommodate cargo (*e.g.*, the area behind the second seat of a station wagon) are not considered a cargo compartment unless these areas were walled off by a solid partition. Please note, a grate fencing is not considered a solid partition. A solid partition is generally composed of a material which limits air flow between areas.

Cargo boxes on pickup trucks are generally separated from the occupant compartment by the back wall of the cab and are classified as a cargo compartment. Please note, operable windows in backlights of pickup cabs are considered part of the solid partition, regardless of opening status.

Light vans will generally not have a separate cargo compartment unless a solid wall was installed.

Origin of Fire (cont'd)

Page 3 of 3

**Instrument panel**

is used when the fire originated under the instrument panel. The instrument panel is defined as the panel extending horizontally from A-pillar to A-pillar and vertically from the lower part of the windshield to the lowest vertical edge of the panel.

**Passenger Compartment area**

is used when the fire initiated within the designated passenger area. This includes cargo areas adjacent to seating areas which were not separated by a solid partition.

**Other location**

is used when none of the other attributes apply. Included in this attribute are fires occurring with wheels or brakes.

**Unknown**

is used when the location of where the fire initiated cannot be determined, e.g.:

- The vehicle was totally destroyed by fire and the origin could not be determined.
- A combination of areas were involved but an estimate of point of origin could not be made.
- A fire was reported, but the vehicle was repaired prior to inspection.

CRUSH LOCATION

Profile #	Event#	Direct Damage Location	Field L Location	Max Crush

The established protocol for obtaining crush data is defined in the *NASS Vehicle Measurement Techniques*.

**PROFILE NUMBER**

**Screen Name:** Profile #

**SAS Data Set:** N/A

**SAS Variable:** N/A

**Oracle Name:** *DAMAGELOCATOR.IMPACTNUMBER*

**Element Attributes:**

**Range:** 1-as assigned

**Source:** Vehicle inspection.

**Remarks:**

This field cannot be edited by the researcher. When the researcher selects an Event # (next variable) the system automatically assigns a Profile # for each profile documented for that event.

**NOTE:**

**For each crush profile to be documented on the profile tab a specific location line must first be completed including:**

- Profile #
- Event #
- Direct Damage Location
- Field L Location
- Max Crush

There can be more than one crush profile for each event. It is imperative that the proper plane is measured. Follow the Vehicle Measurement Techniques guideline.

For rollover crashes the researcher completes one location line for the most crushed component (laterally or vertical).

**EVENT NUMBER**

**Screen Name:** Event #

**SAS Data Set:** N/A

**SAS Variable:** N/A

**Oracle Name:** *EVENTS.EVENTSEQUENCENUMBER*

**Element Attributes:**

**Range:** 1-as selected

**Source:** Vehicle inspection.

**Remarks:**

The researcher chooses from the events that they have previously specified in the case structure for this vehicle.

**NOTE:**

**For each crush profile to be documented on the profile tab a specific location line must first be completed including:**

Profile #  
Event #  
Direct Damage Location  
Field L Location  
Max Crush

**NOTE:** There can be more than one crush profile for each event. There can be more than one crush profile for each event. It is imperative that the proper plane is measured. Follow the Vehicle Measurement Techniques guideline.

**DIRECT DAMAGE LOCATION**

**Screen Name:** Direct Damage Location

**SAS Data Set:** *CDCCRSH*

**SAS Variable:** *DMGLOC*

**Oracle Name:** *DAMAGELOCATOR.LOCATIONDIRECTDAMAGE*

**Element Attributes:**

**Source:** Vehicle inspection.

**Remarks:**

This variable is used to reference a retrievable point on the vehicle for CDC, WinSMASH inputs and Direct D on the damaged plane. Locate an end of damage with respect to the post crash centerpoint or bumper corner of the end plane or, for side impacts, to an undamaged axle. This field is used to assist with CDC assignments. The following examples include the data that are required:

- The left end begins 4 centimeters right of post crash center of the end plane, or
- The rearmost end begins 48 centimeters rearward of the rear axle (side plane)

Rollover damage should be described as area of primary contact, (i.e., Right roof rail or Left side roof rail to center of roof.)



**LOCATION OF FIELD L**

**Screen Name:** Field L

**SAS Data Set:** *CDCCRSH*

**SAS Variable:** *FIELDLOC*

**Oracle Name:** *DAMAGELOCATOR.LOCATIONFIELDL*

**Element Attributes:****Range:****Remarks:**

This variable is used to reference a retrievable point on the vehicle for CDC, WinSMASH inputs and Direct D on the damaged plane. Locate an end of damage with respect to the post crash centerpoint or bumper corner of the end plane or, for side impacts, to an undamaged axle. This field is used to assist with CDC assignments. The following examples include the data that are required:

- Entire end plane or
- C<sub>1</sub> is 102 centimeters forward of the rear axle

A Field L is not measured for rollovers, in the text field "**rollover**" should be entered.

**LOCATION OF MAX CRUSH****Screen Name:** Max Crush**SAS Data Set:** *CDCCRSH***SAS Variable:** *CMAXLOC***Oracle Name:** *DAMAGELOCATOR.LOCATIONMAXCRUSH***Element Attributes:****Source:** Vehicle Inspection**Remarks:**

This variable is used to reference a retrievable point on the vehicle for CDC, WinSMASH inputs and Direct D on the damaged plane. Locate an end of damage with respect to the post crash centerpoint or bumper corner of the end plane or, for side impacts, to an undamaged axle. This field is used to assist with CDC assignments. The following examples include the data that are required:

- located at C<sub>3</sub>
- between C<sub>3</sub> and C<sub>4</sub>
- located 5 centimeters forward of the rear axle

Rollover max crush location should be described as above.

CRUSH PROFILE

Exterior Vehicle Form, Case 2007-996-900015/ Vehicle #2

VEHICLE | TIRE | SPECIFICATIONS | FUEL | FIRE | CRUSH | CDC | EDR | SKETCHES | LOG | REVIEW

LOCATION | PROFILE

Profile # 1 CDC# [dropdown] Field L [input] SMASH L [input]  
ALL MEASUREMENTS ARE IN CENTIMETERS Field L +/-D [input] Direct +/- D [input]  
Category [dropdown] Width (CDC) [input]

Lateral measurement

+/-	Plane of Impact	Max	C1	C2	C3	C4	C5	C6
▶								

Unknown Crush Average [input] [input] [input] [input] [input] [input] [input]

Save Close

**PROFILE NUMBER**

**Screen Name:** Profile #

**SAS Data Set:** N/A

**SAS Variable:** N/A

**Element Attributes:**

**Range:** 1-as assigned

**Source:** Vehicle inspection.

**Remarks:**

This field cannot be edited. The Profile Number that is displayed on the Profile subtab is determined by selecting a specific crush profile on the Crush Profile tab/Location subtab.

**CDC NUMBER****Screen Name:** CDC #**SAS Data Set:** *CDCCRSH***SAS Variable:** *DEFORMNO***Element Attributes:** Generated (# and plane of contact) from documented CDCs**Range:** 1-5**Source:** Vehicle inspection.**Remarks:**

The element attributes are generated from the CDCs entered on the CDC/Detail Tab (e.g. 1-F Front, 2-L Left Side). Select the CDC number that matches the event/damage for which you are going to document the crush profile. There may be multiple CDCs that describe a single impact to a vehicle.

**FIELD L****Screen Name:** Field L**SAS Data Set:** *CDCCRSH***SAS Variable:** *FIELDL***Oracle Name:** *DAMAGELOCATOR.FIELDL***Element Attributes:**

Oracle	SAS	
		Entered number
-9999	999	Unknown

**Range:** 1-1,000**Source:** Vehicle Inspection**Remarks:**

Enter the Field L used during the vehicle inspection to measure the crush profile. The Field L represents both direct and induced damage as measured along the reference line (shock cord). This measurement is used to locate the position of the C-measurements.

Unknown should be used for rollover cases.

**WINSMASH L****Screen Name:** SMASH L**SAS Data Set:** N/A**SAS Variable:** N/A**Oracle Name:** *DAMAGELOCATOR.SMASHL***Element Attributes:**

Oracle	SAS	
		Entered number
-9999	999	Unknown

**Range:** 1-1,000**Source:** Vehicle Inspection**Remarks:**

The WinSMASH L is the "L" that will be used for the WinSMASH program. This equals the **Field L** for all side impacts and for minor end impacts where the direct and induced damage does **not** extend all the way across the endplane. Use the **Undeformed End Width** for all end impacts where the direct and induced damage **extends all** the way across the endplane.

Unknown should be used for rollover cases.

**FIELD L +/- D****Screen Name:** Field L +/- D**SAS Data Set:** *CDCCRSH***SAS Variable:** *FIELDD***Oracle Name:** *DAMAGELOCATOR.D***Element Attributes:**

Oracle	SAS	
		Entered number
-9999	999	Unknown

**Range:** -500 500, 997, 999**Source:** Vehicle Inspection**Remarks:**

This is the Field L +/- D that will be used for the WinSMASH program. It is the measurement from the center of the damaged endplane or wheelbase to the center of the Field L, measured in the field on the damaged vehicle. Indicate whether "D" is a positive or negative value.

Unknown should be used for rollover cases.



**DIRECT +/- D****Screen Name:** Direct +/- D**SAS Data Set:** *CDCCRSH***SAS Variable:** *D***Oracle Name:** *DAMAGELOCATOR.SMASHD***Element Attributes:**

Entered number

**Range:** -390 299, 997, 999, -9999**Source:** Vehicle Inspection**Remarks:**

This is the Direct +/- D that will be used for the WinSMASH program. It is the measurement from the damaged center of the endplane or damaged wheelbase to the center of the direct damage, measured in the field on the damaged vehicle. Indicate whether "D" is a positive or negative value.

Unknown should be used for rollover cases.

**CATEGORY****Screen Name:** Category**SAS Data Set:** N/A**SAS Variable:** N/A**Oracle Name:** *DAMAGELOCATOR.PLANECATEGORY***Element Attributes:**

Oracle	SAS
1	Side
2	End
3	Top (specify)
7	Rollover
4	Under (specify)
-99	Unknown
8	Not Applicable

**Range:****Source:** Vehicle inspection**Remarks:**

This is the impact plane on which measurements are being taken. This field must be selected in order to enter a crush profile.

A fully repaired vehicle should be coded as Not Applicable.

**WIDTH (CDC)****Screen Name:** Width (CDC)**SAS Data Set:** *CDCCRSH***SAS Variable:** *DIRDAMW***Oracle Name:** *DAMAGELOCATOR.WIDTHCDC***Element Attributes:**

Oracle	SAS	
		Entered number
-9999	999	Unknown

**Range:** 1-659, 999**Source:** Vehicle inspection.**Remarks:**

The direct damage width, measured on the vehicle, that is used in determining the CDC for this impact/event.

A CDC width should be obtained for rollover cases. If the CDC begins with 00T, then measure the CDC width laterally with preference given to the greenhouse. If the CDC begins with 00L/R, then measure the CDC width longitudinally.

**VERTICAL LEVEL AT WHICH CRUSH MEASUREMENTS ARE TAKEN FOR A PARTICULAR CRUSH PROFILE.**

**Screen Name:** Plane of Impact

**SAS Data Set:** N/A

**SAS Variable:** N/A

**Oracle Name:** *CRUSHPROFILE.PLANEOFIMPACT*

**Element Attributes:**

Oracle	SAS	
	END PLANE	
21	(+)	Bumper
22	(+)	Above Bumper
23	(-)	Free Space
24	(+)	Stand Adjustment
25	(-)	Stand Adjustment
	SIDE	
1	(+)	Sill
2	(+)	Mid Door
3	(+)	Upper Door
4	(+)	Lower Door
5	(-)	Free Space
6	(+)	Stand Adjustment
7	(-)	Stand Adjustment
	TOP	
30	(+)	Top
	UNDER	
32	(+)	Under
	ROLLOVER (Vertical)	
87		Unknown
70		Right A-pillar
71		Left A-pillar
72		Right B-pillar
73		Left B-pillar
74		Right C-pillar
75		Left C-pillar
76		Right D-pillar
77		Left D-pillar
78		Left windshield header
79		Right windshield header
80		Left back light header
81		Right back light header

Vertical level at which crush measurements are taken for a particular crush profile (cont'd)

Oracle	SAS	
82		Right Roof
83		Left Roof
85		Right Side
84		Left Side
86		Other (specify)

ROLLOVER (Lateral)

60		Unknown
40		Right A-pillar
41		Left A-pillar
42		Right B-pillar
43		Left B-pillar
44		Right C-pillar
45		Left C-pillar
46		Right D-pillar
47		Left D-pillar
48		Left windshield header
49		Right windshield header
50		Left back light header
51		Right back light header
56		Right Roof
54		Left Roof
58		Right Side
57		Left Side
59		Other (specify)

**Source:** Vehicle inspection.

**Remarks:**

On the first line select the vertical level at which the crush profile is measured (*i.e.*, bumper, above bumper, sill, mid-door, etc.). Use Edit/Insert at the top of the screen to insert another line. On the next line(s) select an operator (Free-space and/or Stand Adjustment) to adjust the measurements. The values are entered at the Max and C1 through C6 positions. Then insert another line and select Result for the computer to generate the actual crush. After the results are generated, if changes are made to Cs or freespace, you have to select result again to re-generate the new results. If more than one vertical level is measured for averaging (*i.e.*, bumper and above bumper), then insert another line and select the second vertical level and follow the same procedures as above. After you get your second result, the computer will generate the average at the bottom of the screen.

Vertical level at which crush measurements are taken for a particular crush profile (cont'd)

Note: the operator column +/- is automatically assigned when the attribute is selected. All freespace is (-) subtracted from the C measurements measured to the stringline, while stand adjustments can be either (+) added or (-) subtracted from the C measurements measured to the stringline. If the stands had to be set out further than the overall length of the vehicle, a minus Stand Adjustment

must be used. If the stands had to be set shorter than the overall length of the vehicle, a + Stand Adjustment must be used.

Selection criteria for Rollover (Top) or (Side)

Side Plane measurement protocol:

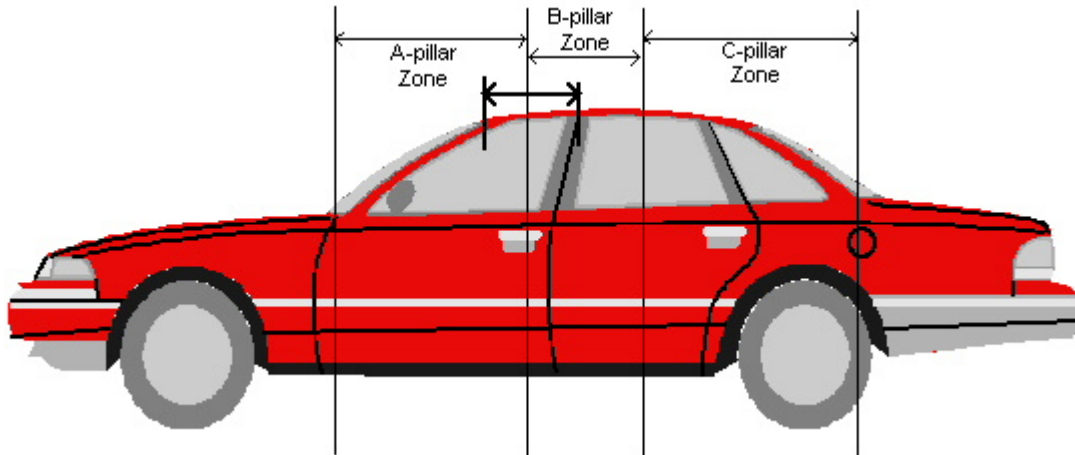

**A-pillar Zone** starts at the base of the A-pillar and extends to half of the width between the windshield top frame point and the mid point of the B-pillar.

**B-pillar Zone** starts where the A-pillar zone ends and extends to the half of the width between the mid point of the B pillar and the mid point of the C-pillar or where the B-pillar ends.

**C-pillar Zone** starts where B-pillar zone ends and extends to the half of the width between the mid point of the C-pillar and the mid point of the D-pillar or where the C-pillar ends.

**D-pillar Zone** starts where C-pillar zone ends and extends to the half of the width between the mid point of the D-pillar and the mid point of the E-pillar or where the D-pillar ends.

Vertical level at which crush measurements are taken for a particular crush profile (cont'd)

Top Plane measurement protocol:

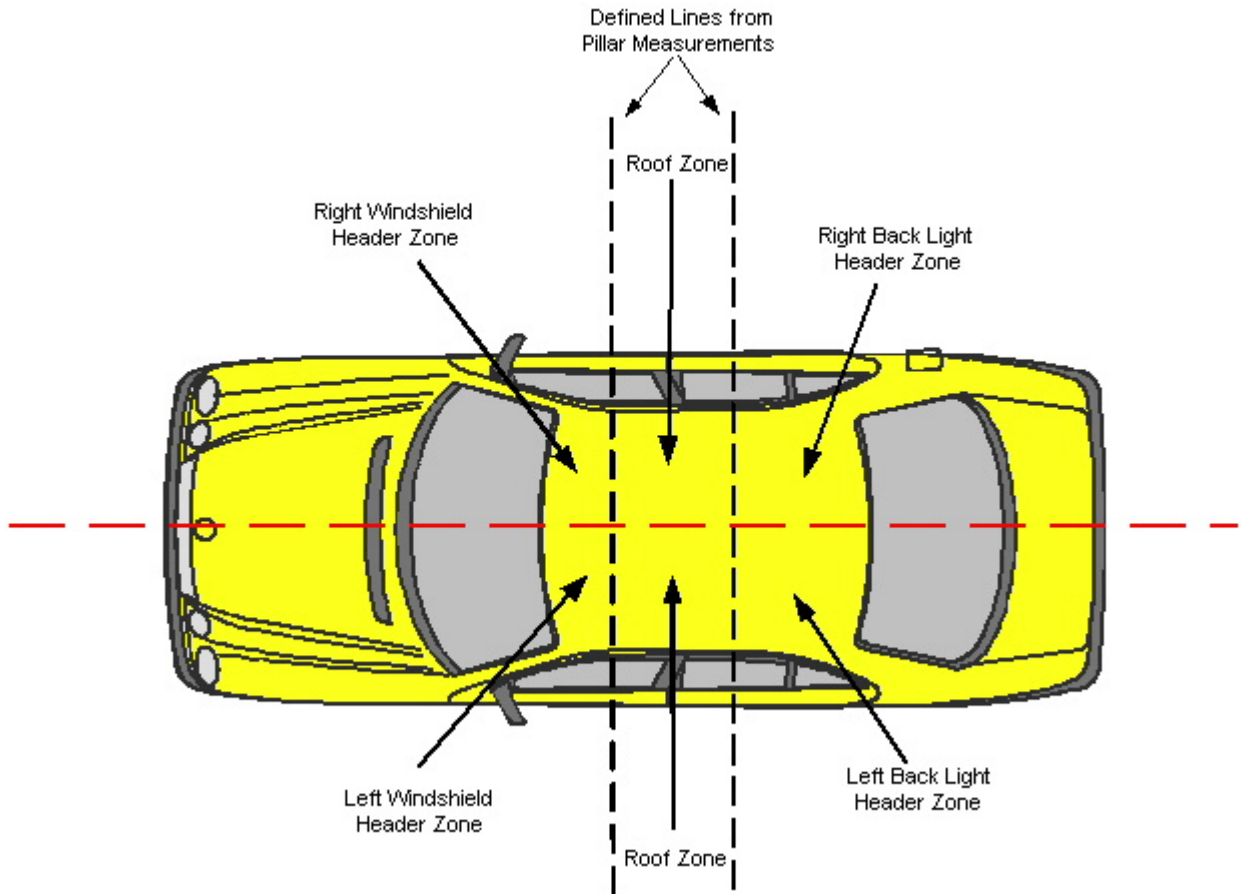

The defined zones created in the Side Plane measurement protocol should be extended onto the Top Plane. This allows for the Top Plane to be zoned as the above illustration depicts. The Roof Zone is the entire area from Windshield Header Zone to the Back Light Header Zone.

Crush caused by contact with an object during the rollover is measured at the component with the maximum amount of crush. This is considered for obtaining the maximum crush for the greenhouse area of the vehicle.

**MAXIMUM CRUSH FOR THIS VERTICAL LEVEL OF CRUSH MEASUREMENTS FOR THIS CRUSH PROFILE**

**Screen Name:** Max

**SAS Data Set:** CDCCRSH

**SAS Variable:** CMAX

**Oracle Name:** CRUSHPROFILE.MAXCRUSH

**Element Attributes:**

Oracle	SAS	
		Entered number
	997	Not applicable
-9999	999	Unknown

**Range:** blank, 0-250, 997, 999

**Source:** Vehicle inspection.

**Remarks:**

This is the maximum crush measured at the vehicle for the profile being documented. Maximum crush is determined after free space is subtracted and/or stand adjustment is added (+) or subtracted (minus) if appropriate.

If the Max crush falls at a C location, the values at that C location must also be entered here, along with any freespace or stand adjustments.

When averaging techniques are used, Max crush is NOT averaged

**Rollover crashes**

This is the maximum crush measured at the component selected in Plane of Impact. A different measurement area can be selected for the Vertical and Lateral measurements.



**C1, C2, C3, C4, C5, C6**

**Screen Name:** C1, C2, C3, C4, C5, C6

**SAS Data Set:** CDCCRSH

**SAS Variable:** C1, C2, C3, C4, C5, C6

**Oracle Name:** CRUSHPROFILE.CRUSH1/CRUSH2/CRUSH3/...CRUSH6

**Element Attributes:**

Oracle	SAS	
		Entered number
	997	Not applicable
-9999	999	Unknown

**Range:** blank, 0-250, 997, 999

**Source:** Vehicle inspection.

**Remarks:**

The damage measurements associated with a specific impact/CDC are entered regardless of the use of a reconstruction program. Record the C-values for each impact to the nearest centimeter.

Record two, four, or six C-measurements (as appropriate) on the line for the crush profile being documented. On the line beneath, annotate the free space to be subtracted and/or stand adjustment. If only 2 or 4 C-values are obtained select N/A for the remaining C-values.

ROLLOVER DOCUMENTATION

The screenshot shows a software window titled "Exterior Vehicle Form, Case 2007-8701-009K/ Vehicle #1". It has a menu bar with options: VEHICLE, TIRE, SPECIFICATIONS, FUEL, FIRE, CRUSH, CDC, EDR, SKETCHES, LOG, REVIEW. Below the menu bar are two tabs: LOCATION and PROFILE. The PROFILE tab is active. In the PROFILE tab, there is a "Profile #" field with the value "1" and a "CDC#" dropdown menu with the value "01FLHN4". Below this, it says "ALL MEASUREMENTS ARE IN CENTIMETERS". There is a "Category" dropdown menu with the value "Rollover" and a "Width (CDC)" field with the value "2".

There are two tables side-by-side. The left table is titled "Lateral measurement" and the right table is titled "Vertical measurement".

	+/-	Plane of Impact	Max
	-	Left B-pillar	200
	+	Comparison	198
	=	Result	2

	+/-	Plane of Impact	Max
	-	Left windshield header	180
	+	Comparison	175
	=	Result	5

Rollover documentation records the maximum crush laterally and vertically. The maximum crush zones are identified differently for the lateral and vertical measurement. The lateral max crush and the vertical max crush can be located at different areas of the vehicle greenhouse. The maximum crush zone will be in the greenhouse area of the vehicle.

In assigning the appropriate CDC in rollover configurations the following is used: 1) principle emphasis is given to the projected area of primary contact (that is, area of greatest crush) rather than initial contact. 2) damage to the greenhouse area ("P" in Column 4) is given priority over other vehicle areas such as "F" and "B".

Contact damage in rollover configurations is classified in accordance with the following: (this is listed in order of descending priority)

- 1) If the projected area of primary contact can be determined, use the appropriate character.
- 2) If the projected area of primary contact cannot be determined, use the angle of force in the vertical plane (above or below the horizontal clockface) to determine the appropriate character. If the direction of force is less than 45 degrees from the vertical axis, use "T". If the direction of force is greater than 45 degrees from the vertical axis, use "L" or "R".
- 3) If the direction of force cannot be determined with sufficient accuracy, use the projected area of the greatest contact to determine the appropriate character. If the deformation area of the left or right side exceeds the deformation of the top, use "L" or "R", respectively. Use "T" if the deformation area is greater on the top.

CDC/SUMMARY

Exterior Vehicle Form, Case 2007-996-900015/ Vehicle #2

VEHICLE | TIRE | SPECIFICATIONS | FUEL | FIRE | CRUSH | CDC | EDR | SKETCHES | LOG | REVIEW

SUMMARY | DETAIL

Event	Object Contacted	Force Dir	Location	Total	Long	Lateral	Energy	Impact	Barrier	Est	Rank

Save Close

CDC/DETAIL

Exterior Vehicle Form, Case 2008-43-093B/ Vehicle #1

VEHICLE | TIRE | SPECIFICATIONS | FUEL | FIRE | CRUSH | CDC | EDR | SKETCHES | LOG | REVIEW

SUMMARY | DETAIL

Event No. 1 GAD Front Previous Next

Object Contacted  
 Category: Vehicle  
 Object: Vehicle#2  
 Deformation Location: R Right Side  
 Long/Lateral: Y Side (F + P) OR End (L + C)  
 Force Direction: 90 degrees  
 Vertical/Lateral: A All  
 Increment: 00 No Shift  
 Distribution: S Sideswipe  
 Clock: 3  
 Extent: Two  
 Over/Underide: None  
 Summary: 03RYAS2  
 Heading Angle: 0

SIDE IMPACT  
 Direct Damage to Pillar(s): Check all that apply  
 A-pillar  C-pillar  Unknown  
 B-pillar  Other (specify)  None

Sill Height: 20 Door Sill Diff: 20 Cmax Height: 20

DELTA V  
 Total: 17 Longtdl: -17 Lateral: -3 Energy: 46221 Impact: 998 Barrier: 23  
 Estimated: Reconstruction Delta V coded Rank: 1  
 Basis: SMASH - Damage only

Save Close

**EVENT NUMBER**

**Screen Name:** Event No.

**SAS Data Set:** *CDCCRSH*

**SAS Variable:** *ACCSEQ*

**Oracle Name:** *EVENTS.EVENTSEQUENCENUMBER*

**Element Attributes:**

Entered number

**Range:** 1-20

**Source:** Vehicle inspection.

**Remarks:**

Once the CDC/Detail tab is selected the researcher must select Edit/Insert from the Main Menu at the top of the screen to activate the tab. This will automatically insert 1 of 1 for the CDC #.

The researcher chooses from the events that they have previously specified in the case structure for this vehicle.

**[DEFORMATION NUMBER]****Screen Name:** N/A**SAS Data Set:** *CDCCRSH***SAS Variable:** *DEFORMNO***Oracle Name:** *DAMAGELOCATOR.IMPACTNUMBER***Element Attributes:**

1 - 5

**Range:** 1-5**Source:** Vehicle inspection.**Remarks:**

Certain impacts to a vehicle require more than one CDC to describe the damage.

One example are impacts with an object such as a fence or cable barrier guardrail where there is continuous contact with the object as it contacts multiple planes of the vehicle. The fence or the cable barrier guardrail initially contacts the front of the vehicle, then as the vehicle proceeds into the fence or cable barrier guardrail, it contacts the vehicle sides and the top of the vehicle. There will be a separate CDC entered for each of these planes.

The other situation involves an impact where the vehicle initially contacts another vehicle with its front then rotates and causes a slap to the side of the vehicle. This would require a different CDC to two different planes.

**GENERAL AREA OF DAMAGE**

**Screen Name:** GAD

**SAS Data Set:** N/A

**SAS Variable:** N/A

**Oracle Name:** *EVENTS.PICKAREAOFDAMAGE*

**Element Attributes:**

**Range:**

**Source:** Roll-up from Case Form/Events

**Remarks:**

The researcher CANNOT enter information in this field. It is entered on the Case Form/Events tab, and rolls-up to this screen.

**OBJECT CONTACTED CATEGORY AND OBJECT**

**Screen Name:** Object Contacted Category and Object

**SAS Data Set:** *CDCCRS*

**SAS Variable:** *OBJCONT*

**Oracle Name:** *EVENTS.PICKOBJECTCONTACT*

**Source:** Vehicle inspection.

**Element Attributes:**

Oracle SAS

01-30 01-30 Vehicle Number

**Noncollision**

31 31 Overturn — rollover (excludes end-over-end)

32 32 Rollover - end-over-end

33 33 Fire or explosion

34 34 Jackknife

35 35 Other intraunit damage

(specify):

36 36 Noncollision injury

38 38 Other noncollision

(specify):

39 39 Noncollision — details

unknown

**Collision With Fixed Object**

41 41 Tree (≤ 10 cm in diameter)

42 42 Tree (> 10 cm in diameter)

43 43 Shrubbery or bush

44 44 Embankment

45 45 Breakaway pole or post (any diameter)

50 50 Nonbreakaway Pole or post (≤ 10 cm in diameter)

51 51 Nonbreakaway Pole or post (> 10 cm but ≤ 30 cm in diameter)

52 52 Nonbreakaway Pole or post (> 30 cm in diameter)

53 53 Nonbreakaway Pole or post (diameter unknown)

54 54 Concrete traffic barrier

55 55 Impact attenuator

56 56 Other traffic barrier (specify):

57 57 Fence

Oracle SAS

58 58 Wall

59 59 Building

60 60 Ditch or culvert

61 61 Ground

62 62 Fire hydrant

63 63 Curb

64 64 Bridge

68 68 Other fixed object

(specify):

69 69 Unknown fixed object

Cable barrier guardrail

48 48 Guardrail Face

49 49 Guardrail End

**Collision with Nonfixed Object**

72 72 Pedestrian

73 73 Cyclist or cycle

74 74 Other nonmotorist or conveyance (specify)

75 75 Vehicle occupant

76 76 Animal

102 77 Railway vehicle

78 78 Trailer, disconnected in transport

79 79 Object fell from vehicle

in-transport

88 88 Other nonfixed object

(specify):

89 89 Unknown nonfixed object

**Other event (specify)**

98 98 Other event (specify):

**Unknown event or object**

99 99 Unknown event or object

Object Contacted Category and Object (cont'd)

Page 2 of 2

**Source:** Researcher determined: primary sources are the scene and vehicle inspections; secondary sources include the police report and interviewees.

**Remarks:**

Once the Event Number is selected the Object Contacted Category and Object will roll-up to these fields from the Case Form/Events Tab. If the event is not listed or incorrect, it must be entered on the Case Form/Events Tab.

SEE CASE FORM/EVENTS TAB FOR DETAILS ON CODING ATTRIBUTES.



**DIRECTION OF FORCE****Screen Name:** Force Direction**SAS Data Set:** *CDCCRS***SAS Variable:** *PDOF***Oracle Name:** *VEHICLEDEFORMATION.DIRECTIONOFFORCE***Element Attributes:**

Oracle	SAS	
		Entered number (to nearest 10 deg)
-8888	998	Non horizontal force
-9999	999	Unknown

**Range:** 0 – 350, 998, 999**Source:** Restricted to vehicle inspection or photographs.**Remarks:****0-350**

An estimated CDC is indicated for each impact. In this estimate, write the principal direction of force in positive increments of ten degrees. Thus, if the direction appeared to be approximately ten degrees to the right of straight-ahead, indicate "10". If the direction of force appeared to be ten degrees left of straight-ahead, indicate "350". The final coding of the CDC reflects the direction of force in clock positions.

**Non-horizontal Force**

Select this any time a vehicle becomes inverted and impacts any object or vehicle while inverted. In addition, use this selection in any other circumstance which is consistent with the directions contained in SAE J224 MAR80.

**Unknown**

Select this when the force direction cannot be determined via vehicle inspection or images/photographs.

**[CLOCK]**

**Screen Name:** Clock

**SAS Data Set:** *CDCCRS*

**SAS Variable:** *CLOCK*

**Oracle Name:** *VEHICLEDEFORMATION.CLOCKFORCE*

**Element Attributes:**

[00 Non horizontal force]

[1 – 12 Direction of clock force]

[99 Unknown]

**Source:** Restricted to vehicle inspection or photographs.

**Remarks:**

The clock direction is a calculation from the **Direction of Force** previously entered.

**INCREMENT OF CLOCK DIRECTION**

**Screen Name:** Increment

**SAS Data Set:** *CDCCRSH*

**SAS Variable:** *SHIFT*

**Oracle Name:** *VEHICLEDEFORMATION.SHIFTINCREMENT*

**Element Attributes:**

Oracle	SAS	
0	00	No shift
20	2 0	End shift vertical up; top shift up
40	4 0	End shift vertical down; top shift rearward
60	60	End, top, or bowing shift lateral right
80	80	End, top, or bowing shift lateral left
-9999	99	Unknown Shift

**Source:** Vehicle inspection

**Remarks:**

The coding of this variable reflects whether the end of the vehicle has been shifted >10 cm. This variable is being collected for use in modifying the CDC for the vehicle.

**00 - No shift**

Less than 10cm of shift or for roof shift, no visible shift

**20 - Up**

Upward shift of >10cm of at least 1 frame rail.

**40 - Down**

Downward shift of >10cm of at least 1 frame rail.

**60 - Right**

End or top shift lateral right. This includes bowing to the right

**80 - Left**

End or top shift lateral left. This includes bowing to the left

**Unknown**

Use this when it cannot be determined whether the vehicle has end shift or bowing >10 cm.

To select lateral end shift, both frame rails or the entire end (of a uni-body) must shift >10cm.

Increment of Clock Direction (cont'd)

Page 2 of 2

To select vertical end shift, only one frame rail (nearest the direct damage) needs to shift >10cm.

To select lateral shift for bowing (side impact, measured on the opposite side of the impact) only one bumper corner has to bow (shift) laterally >10cm.

**OVERRIDE/UNDERRIDE (THIS VEHICLE)**

**Screen Name:** Over/Underride

**SAS Data Set:** *CDCCRS*

**SAS Variable:** *RIDEUP*

**Oracle Name:** *VEHICLEDEFORMATION.PICKOVERRIDE*

**Element Attributes:**

Oracle	SAS	
	1	None
	2	Override
	3	Underride
	4	Medium/heavy truck or bus override
	9	Unknown

**Source:** Vehicle inspection (with exceptions as noted).

**Remarks:**

**None**

Is selected when both vehicles are inspected and there is no override/underride, or not an end-to-end impact between two CDS vehicles; or no medium/heavy truck or bus override.

**Override**

Is selected when 2 CDS applicable vehicles are involved in an end-to-end impact, and this vehicle overrides the other vehicle

**Underride**

Is selected when 2 CDS applicable vehicles impact (end-to-end), and this vehicle underrides the other vehicle .

**Medium/heavy truck or bus override**

Is selected when a CDS applicable vehicle's end impacts with the end or side of a medium/heavy truck or bus and this CDS vehicle's end (front or back) underrides the medium/heavy truck or bus.

**Unknown**

It cannot be determined if an override/underride occurred, or the impact configuration for two CDS applicable vehicles cannot be determined.

Override/Underride is coded from the perspective of vehicle impact configuration and is *not* based on: coding in columns 5 and/or 6 of the CDC, or vehicle measurement techniques (*i.e.*, the "13-centimeters" rule for WinSMASH purposes). It is only relevant for end-to-end impacts

between two CDS applicable vehicles, or any impact between a CDS applicable vehicle's end (front or back) and the end or side of a Medium/heavy truck or bus.

This variable is intended to capture those instances where there is an uneven damage pattern caused by uneven amounts of crush at different vertical levels of the front and/or rear planes of the vehicle. Because of the different crush stiffness' involved in these locations, these variables are included to alert the vehicle safety analysts to uneven crush patterns in front and rear impacts, which are not identified in the CDC (*i.e.*, columns 5 and/or 6).

For this variable an impact with a not-in-transport vehicle (either CDS applicable or a medium/heavy truck) is considered a vehicle-to-vehicle impact and not a vehicle-to-object impact.

The term "override" means a vehicle overrode (*i.e.*, goes on top of) the bumper (front or rear) of the other vehicle (except for trucks/buses where the impact configuration does not matter.) The term "underride" means a vehicle underrode (*i.e.*, goes below) the bumper (front or rear) of the other vehicle (except for trucks/buses where the impact configuration does not matter.)

If a vehicle is not equipped with a bumper (*e.g.*, rear of some pickup trucks), then consider the equivalent end structure for coding these variables.

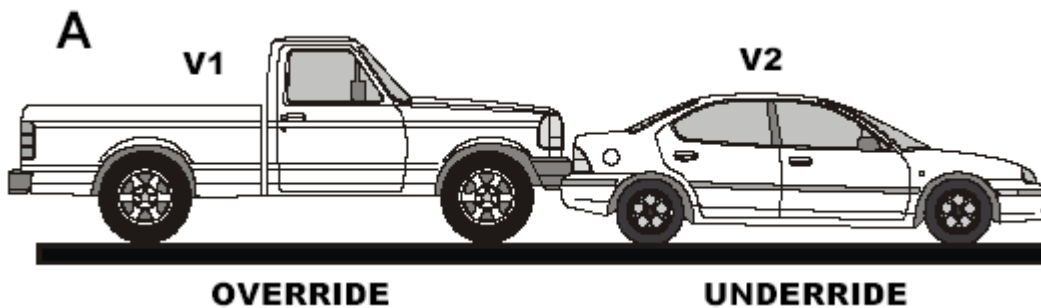

As indicated in **Situation A**, the trunk area of V2 is damaged (*i.e.*, "crushed") while the rear bumper is relatively undisturbed. Hence, the uneven damage pattern. Conversely, the front of V1 is "crushed" at bumper height only, or is crushed *uniformly* at the bumper and grille levels (*i.e.*, an "even" damage pattern). Even though V1 may not exhibit the uneven damage pattern, it would still receive an applicable override code due to the resultant underride damage to V2.

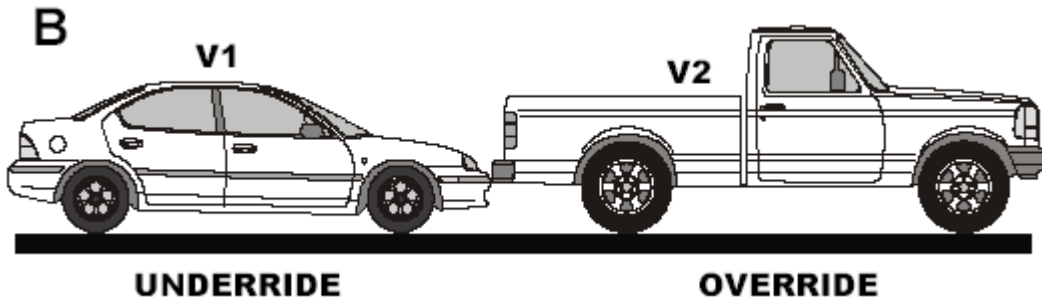

When the bumper receives measurable crush and the area above the bumper also receives measurable crush, the override/underride codes are applicable if the impact configuration applies.

For example, (**Situation B**) the front bumper (V1) may be crushed 2" rearward and the grille area may be crushed 6" rearward. While the averaging technique rule for WINSMASH does not apply for the different levels of crush, the impact may in fact meet the configuration rule for the override/underride variables.

**HEADING ANGLE**

**Screen Name:** Heading Angle

**SAS Data Set:**

**SAS Variable:**

**Oracle Name:** *VEHICLEDEFORMATION.HEADINGANGLE*

**Element Attributes:**

Oracle	SAS	
	000-355	Code actual value in 5 degree increments
-9999	999	Unknown
		Not Applicable

**Source:** Scene diagram.

**Remarks:**

Heading Angle records the heading angle for this vehicle for the below described circumstances:

- Vehicle to vehicle impacts only.
- Vehicle must have a Winsmash run.
- The heading angle is to be coded for the highest calculated delta V for this vehicle.

Use the scene diagram referencing system to determine the heading angles at the point of impact for *this vehicle and for this CDC only*. All measurements are referenced to the north arrow on the diagram. The heading angle of each vehicle is determined by projecting the longitudinal axis of the vehicle through the extension of the north arrow. The angle value is obtained by using a 360-degree protractor and measuring in a clockwise direction from the north arrow, in 5 degree increments. The north arrow always represents 0- (degrees). The angle is a positive value. The following diagrams exemplify the measurement technique.

**Unknown**

is used when the heading angle can not be determined.

**Not Applicable**

is used when the crash configuration doesn't meet the above criteria,(i.e., non-horizontal impact).

Heading angles example:



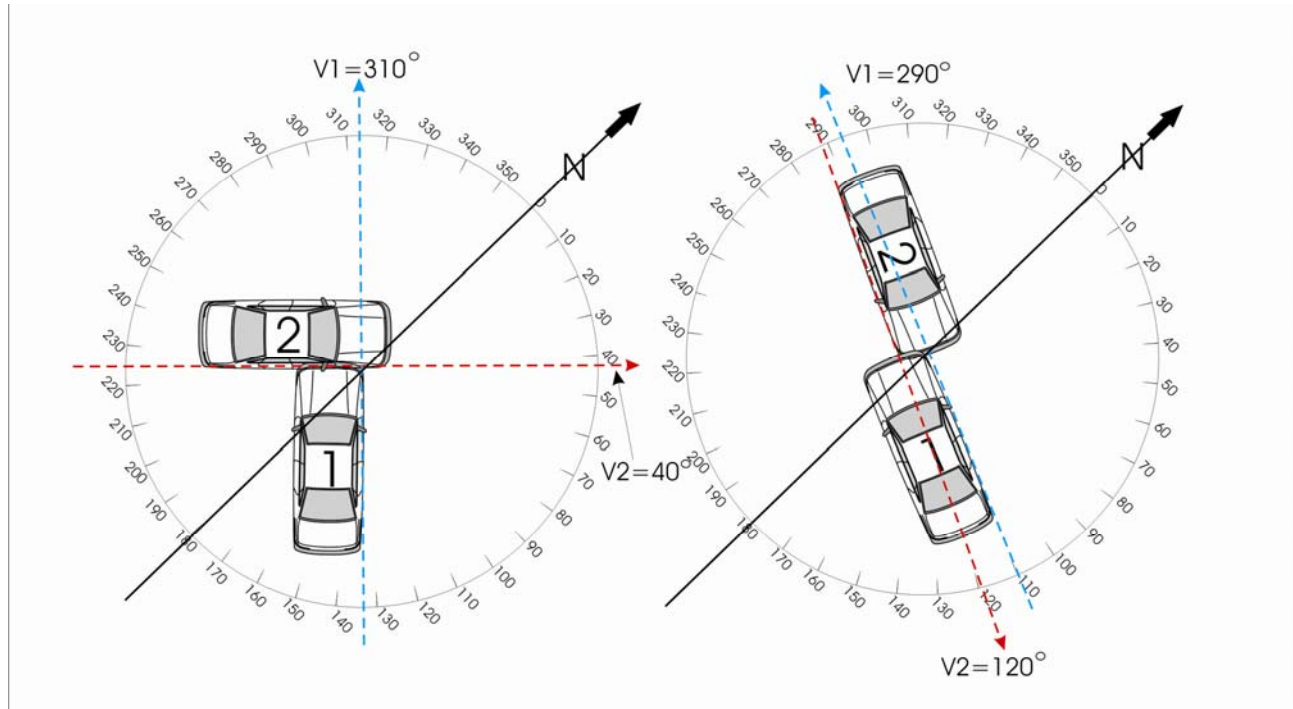

**DEFORMATION LOCATION**

**Screen Name:** Deformation Location

**SAS Data Set:** *CDCCRSH*

**SAS Variable:** *GAD*

**Oracle Name:** *VEHICLEDEFORMATION.DEFORMATIONLOCATION*

**Element Attributes:**

Oracle	SAS	
F	F	Front
R	R	Right side
L	L	Left side
B	B	Back (rear)
T	T	Top
U	U	Undercarriage
9	9	Unknown

**Source:** Restricted to vehicle inspection or photographs.

**Remarks:**

Refer to the documents entitled: SAE J224MAR80 and "Collision Deformation Classification Training Program: Intermediate Level — Training/Reference Module", for detailed definitions of the Element Attributes as well as instruction on proper usage.

In assigning the appropriate CDC in rollover configurations the following is used: 1) principle emphasis is given to the projected area of primary contact (that is, are of greatest crush) rather than initial contact. 2) damage to the greenhouse area ("P" in Column 4) is given priority over other vehicle areas such as "F" and "B". "

Contact damage in rollover configurations is classified in accordance with the following: (this is listed in order of descending priority)

1. If the projected area of primary contact can be determined, use the appropriate character.
2. If the projected area of primary contact cannot be determined, use the angle of force in the vertical plane (above or below the horizontal clockface) to determine the appropriate character. If the direction of force is less than 45 degrees from the vertical axis, use "T". If the direction of force is greater than 45 degrees from the vertical axis, use "L" or "R".

3. If the direction of force cannot be determined with sufficient accuracy, use the projected area of the greatest contact to determine the appropriate character. If the deformation area of the left or right side exceeds the deformation of the top, use "L" or "R", respectively. Use "T" if the deformation area is greater on the top.

**SPECIFIC LONGITUDINAL OR LATERAL LOCATION**

**Screen Name:** Long/Lateral

**SAS Data Set:** *CDCCRS*

**SAS Variable:** *SHL*

**Oracle Name:** *VEHICLEDEFORMATION.LONGLATLOCATION*

**Element Attributes:**

Oracle	SAS		Oracle	SAS
		<b>Front, Rear</b>		<b>Top or Undercarriage/Side Impact</b>
9	D	Distributed-side or end	18	D Distributed (F+P+B)/Side or end
10	L	Left-front or rear	19	F Front Section
11	C	Center-front or rear	20	P Center Section
12	R	Right-front or rear	21	B Rear Section
13	F	Side front-left or right	22	Y F+P
14	P	Side center section - L or R	23	Z P+B
15	B	Side rear - left or right		F Side front — left or right
16	Y	Side (F + P) or end (L + C)		P Side center section — L or R
17	Z	Side (P + B) or end (C + R)		B Side rear — left or right
59	9	Unknown	24	9 Unknown
				L Left — front or rear
				C Center — front or rear
				R Right- — front or rear

**Source:** Restricted to vehicle inspection or photographs.

**Remarks:**

Refer to the documents entitled: SAE J224 MAR80 and "Collision Deformation Classification Training Program: Intermediate Level — Training/Reference Module", for detailed definitions of the Element Attributes as well as instruction on proper usage.

For the purpose of determining the “P” zone of a mini-van or an SUV, treat them as a station wagon. The “P” zone of a station wagon is defined as from the base of the windshield to the rear of the second seat.

**SPECIFIC VERTICAL OR LATERAL LOCATION****Screen Name:** Vertical/Lateral**SAS Data Set:** *CDCCRS***SAS Variable:** *SVL***Oracle Name:** *VEHICLEDEFORMATION.VERTLATLOCATION***Element Attributes:**

Oracle SAS

**CDC (Vertical - Front, Rear, or Side Impacts)**

25	A	All
26	H	Top of frame to top
27	E	Everything below belt line
28	G	Belt line and above
29	M	Middle — top of frame to belt line or hood
30	L	Frame — top of frame, frame, bottom of frame (including undercarriage)
31	W	Below undercarriage level (wheels and tires only)
32	9	Unknown

**CDC (Lateral - Top and Undercarriage Impacts)**

33	D	Distributed
34	L	Left
35	C	Center
36	R	Right
37	Y	Left and Center (L + C)
38	Z	Right and Center (R + C)
39	9	Unknown

**Source:** Restricted to vehicle inspection or photographs.**Remarks:**

Refer to the document entitled: SAE J224 MAR80 and "Collision Deformation Classification Training Program: Intermediate Level — Training/Reference Module", for detailed definitions of the Element Attributes as well as instruction on proper usage.

**TYPE OF DAMAGE DISTRIBUTION**

**Screen Name:** Distribution

**SAS Data Set:** *CDCCRS*

**SAS Variable:** *TDD*

**Oracle Name:** *VEHICLEDEFORMATION.DAMAGEDISTRIBUTION*

**Element Attributes:**

Oracle	SAS	
40	W	Wide impact area
41	N	Narrow impact area
42	S	Sideswipe
43	O	Rollover (includes side)
44	A	Overhanging structure
45	E	Corner
46	K	Conversion impact type
47	U	No residual deformation
48	9	Unknown

**Source:** Restricted to vehicle inspection or photographs.

**Remarks:**

Refer to the documents entitled: SAE J224 MAR80 and "Collision Deformation Classification Training Program: Intermediate Level — Training/Reference Module", for detailed definitions of the Element Attributes as well as instruction on proper usage.

**Note:** When recording a "K" conversion impact type enter the first half of the "K" conversion in one CDC and enter the second half of the "K" conversion in the next CDC.

**DEFORMATION EXTENT GUIDE**

**Screen Name:** Extent

**SAS Data Set:** *CDCCRS*

**SAS Variable:** *EXTENT*

**Oracle Name:** *VEHICLEDEFORMATION.DAMAGEEXTENT*

**Element Attributes:**

Oracle	SAS	
49	1	One
50	2	Two
51	3	Three
52	4	Four
53	5	Five
54	6	Six
55	7	Seven
56	8	Eight
57	9	Nine
58	99	Unknown

**Source:** Restricted to vehicle inspection or photographs.

**Remarks:**

Extent zone is based on direct damage only. When two crush profiles are averaged, use the largest maximum **resultant** crush for your extent zone (*i.e.*, do not average the maximum crush).

Refer to the documents entitled: SAE J224 MAR80 and "Collision Deformation Classification Training Program: Intermediate Level — Training/Reference Module", for detailed definitions of the Element Attributes as well as instruction on proper usage.

SIDE IMPACT

Exterior Vehicle Form, Case 2008-43-093B / Vehicle #1

VEHICLE | TIRE | SPECIFICATIONS | FUEL | FIRE | CRUSH CDC | EDR | SKETCHES | LOG | REVIEW

SUMMARY | **DETAIL**

Event No. 1 GAD Front Previous Next

Object Contacted  
Category Vehicle Deformation Location R Right Side  
Object Vehicle#2 Long/Lateral Y Side (F + P) OR End (L + C)  
Force Direction 90 degrees Vertical/Lateral A All  
Increment 00 No Shift Distribution S Sideswipe  
Clock 3 Extent Two  
Over/Underride None Summary 03RYAS2  
Heading Angle 0

**SIDE IMPACT**  
Direct Damage to Pillar(s): Check all that apply

A-pillar  C-pillar  Unknown  
 B-pillar  Other (specify)  None

Sill Height 20 Door Sill Diff 20 Cmax Height 20

**DELTA V**

Total	Longtdl	Lateral	Energy	Impact	Barrier	Estimated	Rank
17	-17	-3	46221	998	23	Reconstruction Delta V coded	1

Basis SMASH - Damage only

Save Close



**DIRECT DAMAGE TO PILLAR(S)**

**Screen Name:** Direct Damage to Pillar(s)

**SAS Data Set:**

**SAS Variable:**

**Oracle Name:** CDCPILLAR.PILLARID

**Element Attributes:**

Oracle	SAS
1	A-pillar
2	B-pillar
3	C-pillar
4	Other (specify)
-9999	Unknown
-9998	None
-8887	Not Applicable

**Source:** Vehicle inspection.

**Remarks:**

Select all that apply.

This variable applies to the following crash configurations:

- Vehicle to vehicle
- Frontal plane to side plane
- Only for vehicle with side plane impact damage
- CDC 4th character of D, P, Y or Z

This variable only captures those *vehicle-to-vehicle* impacts where the other contacting vehicle sustained an associated frontal impact. The other contacting vehicle must be a CDS applicable vehicle.

This indicates that the vehicle sustained direct damage to a pillar from the striking vehicle. This variable applies observations of the researcher at the time of inspection.

**Other (specify)**

is used to describe a pillar that sustains direct damage from the striking vehicle that is not listed in the given attribute list.

Direct Damage to Pillar(s)

Page 2 of 2

**Unknown**

is used when the researcher can not determine if any pillar sustained direct damage from the striking vehicle.

**None**

is used when the researcher does not observe direct pillar damage at the time of inspection.

**Not Applicable**

is used when the max crush falls outside of the "P" zone.

**VERTICAL HEIGHT OF SILL**

**Screen Name:** Sill Height

**SAS Data Set:**

**SAS Variable:**

**Oracle Name:** *VEHICLEDEFORMATION.SILLHEIGHT*

**Element Attributes:**

Oracle	SAS	
		Enter to the nearest centimeter
-8887	887	Not Applicable
-9999	999	Unknown

**Range:** 005-100, 887, 999

**Source:** Vehicle inspection, exemplar vehicle, manufacturer specifications

**Remarks:**

**Enter to the nearest centimeter**

Measure the vertical distance between the ground and the sill where it meets the door seam at or as near as possible to the b-pillar. The preferred measurement is taken at the vehicle inspection. This measurement is the precrash condition of the vehicle.



This variable only captures those *vehicle-to-vehicle* impacts where the other contacting vehicle sustained an associated frontal impact. The other contacting vehicle must be a CDS applicable vehicle. In addition, the measurement is only captured for those impacts where CDC columns 3 and 4 for this vehicle equal LY, LP, LZ, LD, RY, RP, RZ, or RD.

For vehicles with post-manufacturer modifications (certified or not) exemplar vehicles or manufacturer specifications should not be used. In addition, if the vehicle has sustained post-crash damage such that the measurement would not reasonably approximate the precrash height use the

**Note:**

The presence of flat tires alone would not disqualify the capture of a known measurement.

**Not Applicable**

Use this code for impacts where CDC column 3 and 4 do not equal LY, LP, LZ, LD, RY, RP, RZ, or RD. This code is also used when the other vehicle does not sustain an associated frontal impact, or is not a CDS applicable vehicle. Use this code when the max crush falls outside of the "P" zone. For the purpose of determining the "P" zone of a mini-van or an SUV, treat them as a station wagon. The "P" zone of a station wagon is defined as from the base of the windshield to the rear of the second seat.

**Unknown**

When the measurement cannot be determined or reasonably approximated.

**HEIGHT OF MAX DOOR CRUSH**

**Screen Name:** Cmax Height

**SAS Data Set:**

**SAS Variable:**

**Oracle Name:** *VEHICLEDEFORMATION.CMAXHEIGHT*

**Element Attributes:**

Oracle	SAS	
		Enter to the nearest centimeter
-9999		Unknown
-8887		Not Applicable

**Source:** Vehicle inspection.

**Remarks:**

This measurement is obtained at the time of the vehicle inspection. Do not use an exemplar vehicle or manufacturer specifications for this variable.

This variable applies to the following crash configurations:

- Vehicle to vehicle
- Frontal plane to side plane
- Only for vehicle with side plane impact damage
- CDC column 4 character of D, P, Y or Z

**Enter to the nearest centimeter**

Measure the vertical distance between the ground and area of the max crush sustained in the “P” zone.” For the purpose of determining the “P” zone of a mini-van or an SUV, treat them as a station wagon. The “P” zone of a station wagon is defined as from the base of the windshield to the rear of the second seat.

This variable only captures those *vehicle-to-vehicle* impacts where the other contacting vehicle sustained an associated frontal impact. The other contacting vehicle must be a CDS applicable vehicle.

Care should be taken when determining this post-crash measurement. If the vehicle has had post-manufacturer modifications (certified or not) the use of exemplar vehicles or manufacturer specifications should not be used. In addition, if the vehicle has sustained other post-crash damage such that the measurement would not correctly capture the height (e.g. missing wheel, vehicle split

in half) use the Unknown code. The presence of flat tires alone would not disqualify the capture of a known measurement.

**Unknown**

is used when the researcher can not obtain or determine the height of the max crush.

**Not Applicable**

is used when the max crush falls outside of the “P” zone.

Example:

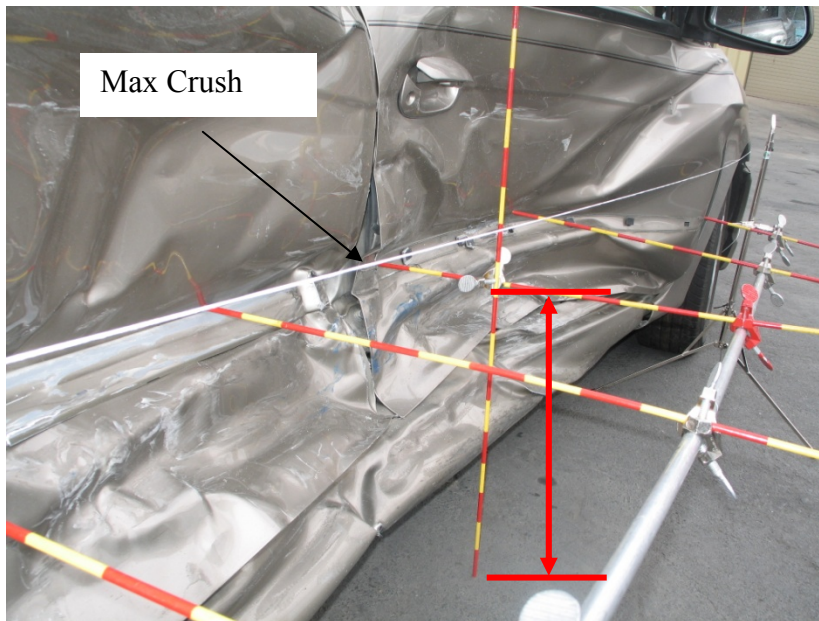

**DOOR SILL DIFFERENTIAL (DSD)**

Page 1 of 2

**Screen Name:** Door Sill Diff**SAS Data Set:****SAS Variable:****Oracle Name:** *VEHICLEDEFORMATION.DOORSILLDIFF***Element Attributes:**

Oracle	SAS	Enter to the nearest centimeter
-9999		Unknown
-8887		Not Applicable

**Source:** Vehicle inspection.**Remarks:**

This variable captures the post-crash lateral distance between the sill level versus the maximum crush in the “P”-zone. Measure this when ever the max crush is in the “P” zone. For the purpose of determining the “P” zone of a mini-van or an SUV, treat them as a station wagon. The “P” zone of a station wagon is defined as from the base of the windshield to the rear of the second seat.

This variable applies to the following crash configurations:

- Vehicle to vehicle
- Frontal plane to side plane
- Only for vehicle with side plane impact damage
- CDC column 4 character of D, P, Y or Z

This variable only captures those *vehicle-to-vehicle* impacts where the other contacting vehicle sustained an associated frontal impact. The other contacting vehicle must be a CDS applicable vehicle.

**Enter to the nearest centimeter**

Measure the lateral distance between the sill versus the maximum crush in the “P” zone. The measurement between two positions should be on the same vertical plane.

The measurement must be taken at a right angle to the vehicle's longitudinal axis.

Measurement at the sill level would be taken at the outermost portion of the sill.

## Door Sill Differential (DSD) (cont'd)

Page 2 of 2

Code "0" for those situations when the maximum "P" zone crush falls outside the perimeter of the sill (e.g. negligible crush).

Zero would also be used in those situations where all qualifying criteria are met, but no contact is made to the door panel.

**Unknown**

is used when the researcher can not determine or obtain the DSD.

**Not Applicable**

is used when the max crush is outside of the "P" zone.





### **WINSMASH OVERVIEW**

The WinSMASH software is a simplified two dimensional mathematical analysis of a vehicle's crash events. The software is designed to reconstruct vehicle-to-vehicle collisions and vehicle-to-large object collisions and make a standardized assessment of the severity of an impact. The software uses detailed measurements from the crash scene, vehicle damage and vehicle stiffness characteristics to compute energy absorbed by the vehicle to estimate the change in velocity, Delta-V and Barrier Equivalent Speed (BES).

Delta-V is the change in velocity of the vehicles during approach period, i.e. the time between initial contact and when the maximum crush occurs (and common velocity attained) at the interface. The delta-V is considered a good indicator of the crash severity because it approximates the speed of the collision between the vehicle's occupants and the interior that causes injuries. The BES is defined as the speed with which a vehicle would have to collide with a fixed barrier in order to absorb the same amount of energy or produce the same amount of crush. No information from the collision partner is required to estimate the BES.

The WinSMASH program can also compute the impact speed if detailed measurements of impact and final rest positions are entered into the program. The program assumes the impact was instantaneous and at some point during the impact both vehicles reached a common velocity. The vehicle properties are averaged properties for the vehicle class. Uniform crush stiffness is assumed across the front, rear and side of the vehicle. Due to these assumptions, WinSMASH can't be used for the following collisions:

- Rollovers
- Sideswipes
- Non-horizontal forces
- Severe override/underride
- Undercarriage impacts
- Multiple impacts to the same area

For collisions where not enough information is available to calculate the energy dissipated by the collision partner, WinSMASH can only be used to compute the BES using the Vehicle-to-Barrier option. The following collisions should be set-up with the Vehicle-to-Barrier option and only the **BES** should be entered into NASSMAIN:

- Yielding Fixed Objects
- Animals/Pedestrians/Cyclists
- Moving Railway Vehicles/Large Trucks
- Towed Trailer or Vehicles

Two separate and independent methods, namely **Damage Analysis** and **Trajectory Analysis**, can be used to estimate the change in vehicle speeds experienced by the vehicles.

### Damage Analysis

The Damage Analysis algorithm is the most often used option in WinSMASH. The Damage Analysis makes use of detailed measurements of the structural deformation of each vehicle to arrive at an estimate of the energy required to produce the observed vehicle damage. The program assumes a linear relationship between the crush energy and the depth of residual crush. This algorithm can be used to generate Delta-V when the scene data is not available. The input data needed for Damage Analysis are: Crush Profile, Vehicle Specifications, Vehicle Size and Stiffness Categories. Based on the length of the wheelbase, the vehicles are grouped into seven size categories and eight stiffness categories. Each stiffness category is assigned a single set of stiffness coefficients: d0 and d1. Users select the size and stiffness coefficients based upon the length of the wheelbase of the automobile. The program assumes that similar size vehicles have similar stiffness characteristics. Because the Delta-V is based entirely on vehicle deformation, care must be taken to provide accurate information.

**Note:** Refer to Appendix A for changes in the Stiffness value of certain vehicle types.

#### Example A: Summary of WinSMASH results using Damage Analysis

Vehicle 1	
	Speed Change (Damage)
Total:	19.0 km/h
Longitudinal:	17.9 km/h
Latitudinal:	6.5 km/h
PDOF:	200.0 deg
Energy Dissipated	11484 Joules
Moment Arm of Principal Force	-40.7 cm CCW
Barrier Equivalent Speed	10.1 km/h
Change in Angular Velocity	-50.0 degrees/second
Used the d0 and d1 values estimated from vehicle size	

Vehicle 2	
	Speed Change (Damage)
Total:	34.0 km/h
Longitudinal:	-33.5 km/h
Latitudinal:	-5.9 km/h
PDOF:	10.0 deg
Energy Dissipated	93556 Joules
Moment Arm of Principal Force	-12.6 cm CCW
Barrier Equivalent Speed	40.2 km/h
Change in Angular Velocity	-34.8 degrees/second
Used the d0 and d1 values estimated from vehicle size	

**Damage & Trajectory Analysis**

The Trajectory Analysis makes use of trajectory data (e.g. skid marks, impact positions and final rest positions). It is based on work-energy relationships for the spinout and the conservation of linear momentum for the collision. The program estimates the vehicle separation speed from the information about the rest position, skid marks, local friction, point of collision, etc. The momentum equations are used to compute the impact speed.

This subroutine calculates either a damage or a trajectory estimate in axial (velocity vectors are within ten degrees of parallel) collisions or a Conservation of Linear Momentum solution in angular collisions greater than ten degrees. Because the scene data are calculated separately in the Conservation of Linear Momentum solution, a separate Delta-V is generated and a comparison with the Damage Delta-V can be made for accuracy.

**Reconciliation Of Different Results Between Damage And Trajectory (WinSMASH)**

1. The axial collision solution is used when the initial velocity vectors are within ten degrees of parallel, i.e. collinear impacts. Examples of use in WinSMASH are: head-on collisions, rear-end collisions, vehicles sliding sideways traveling straight into an oncoming vehicle or a stationary barrier, barrier impacts, etc.

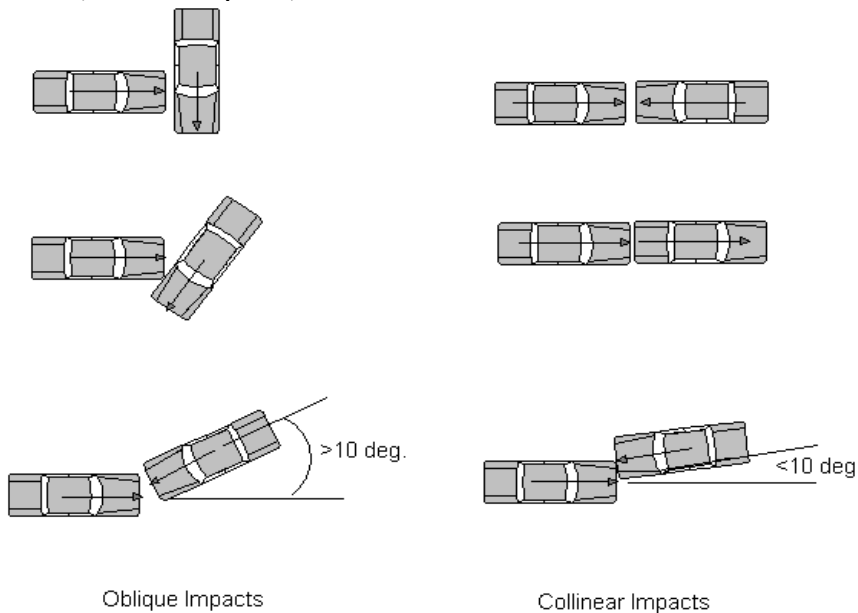

The transition between the axial and angular solutions (*i.e.*, a velocity vector change from within ten degrees of parallel to just outside ten degrees of parallel) may sometimes produce abrupt changes in Delta-V results. Therefore, the researcher should remember to examine the results carefully.

The axial collision printout will calculate impact speed (spinout and damage) and the SPEED CHANGE (DAMAGE), which should be used if the results are reasonable.

**Example B: SUMMARY OF WinSMASH RESULTS USING DAMAGE & TRAJECTORY FOR AN AXIAL COLLISION (<10°)**

	Speed Change (Damage)	Impact Speed (Damage and Spinout)
Total:	77.0 km/h	93.6 km/h
Longitudinal:	-77.0 km/h	93.6 km/h
Latitudinal:	0.0 km/h	0.0 km/h
PDOF:	0.0 deg	
Energy Dissipated	489401 joules	Moment Arm of Principal Force -54.0 cm CCW
Barrier Equivalent Speed	77.3 km/h	Change in Angular Velocity -286.4 degrees/second
Used the d0 and d1 values estimated from vehicle size		

2. The conservation of linear momentum solution is used for angled or oblique collisions (greater than ten degrees from parallel). The reconstruction program produces two independent estimates of Delta-V. The Total, Longitudinal, and Lateral Delta-Vs associated with “**Damage Analysis**” should be compared respectively to the total, longitudinal and lateral Delta-Vs associated with “**linear momentum and trajectory analysis.**” The results will seldom be precisely equal. Experience indicates that a satisfactory agreement exists between two estimates when their Delta-V components differ by no more than 4 kmph or ten (10) percent, whichever is greater, and the angles are within the same o'clock direction. Be sure, when comparing Delta-Vs, to compare the respective components calculated from two methods. When the agreement is not satisfactory, the data associated with each option should be reviewed for accuracy.

Once the speed changes agree satisfactorily, the results for Total, Longitudinal, and Lateral speed changes are each averaged and the averaged values must be entered on the Exterior Vehicle Form. If agreement cannot be reached between the two methods, contact your zone center.

**Example C: Vehicle Trajectory simulation (<math><10^\circ</math>)**

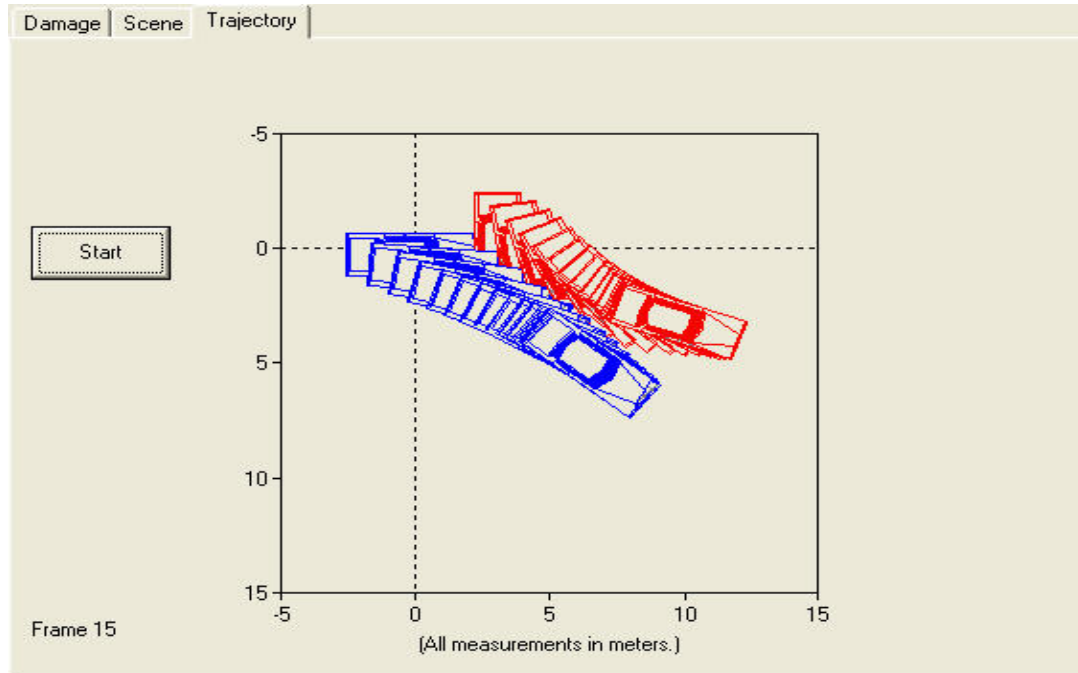

**Calculation Types**

The following sections describe the various calculation type options available in the program. **Note:** the integrated version of the WinSMASH program pre-fills most of the fields in the program using data entered in NASSMAIN. The user can only change: stiffness category, weight, heading angle and PDOF. The integrated WinSMASH should only be rerun if any of the data used in the program is updated in NASSMAIN.

**1) Standard**

The standard option is used to reconstruct vehicle-to-vehicle collisions when input data for both vehicles are available. Both Damage Analysis and Trajectory Analysis can be used in this option. The program will only use the damage analysis algorithm if scene data is not entered in the program. For a standard reconstruction the following data are required:

**a) Damage analysis**

<b>V1</b>	<b>V2</b>
Vehicle Specifications, Curb Weight	Vehicle Specifications, Curb Weight
Crush Profile (C <sub>1</sub> - C <sub>n</sub> ), Damage Length	Crush Profile (C <sub>1</sub> - C <sub>n</sub> ) Damage Length
CDC	CDC
Heading Angle and PDOF	Heading Angle and PDOF
Size and Stiffness Category	Size and Stiffness Category

**b) Damage and Trajectory Analysis (the following additional data are required)**

Impact location and final rest position	Impact location and final rest position
Slip Angle and Friction	Slip Angle Friction

**2) Barrier**

The Barrier option is used to reconstruct a vehicle impact with a fixed object. This option works the same way as the standard option, except that input data for only one vehicle are entered. This option is also used to compute the BES of the vehicle in collisions that violate the assumptions of the WinSMASH model e.g., impact with yielding objects, animals/pedestrian/cyclists, moving railway vehicles/large trucks, towed trailers or vehicles, or multiple impacts to the same area

**a) Damage Analysis**

<b>V1</b>
Vehicles Specifications, Curb Weight
Crush Profile (C <sub>1</sub> - C <sub>n</sub> ), Damage Length
CDC
Heading Angle and PDOF
Size and Stiffness Category

**b) Damage and Trajectory Analysis (the following additional data are required)**

Impact Location and Final Rest Position
Slip Angle and Friction

**3) Missing Vehicle**

The Damage Analysis algorithm also has the option (Missing Vehicle) to estimate the Delta-V when the data for one of the vehicles in a vehicle-to-vehicle collision is missing. The same assumption outlined above applies to the Missing Vehicle algorithm. Collisions that violate those assumptions can't be modeled with Missing Vehicle option. In the Missing Vehicle algorithm the energy absorbed by the missing vehicle is directly computed from the known vehicle energy. The following data are required for a Missing Vehicle option:

**Damage analysis**

<b>V1</b>	<b>V2</b>
Vehicles Specifications, Curb Weight	Vehicles Specifications, Curb Weight
Crush Profile (C <sub>1</sub> - C <sub>n</sub> ), Damage Length	--
CDC	General Area of Damage
Heading Angle and PDOF	Heading Angle
Size and Stiffness Category	Size and Stiffness Category

**4) CDC Only**

The CDC Only option is used for vehicle-to-vehicle collisions when insufficient damage data are documented for one of the vehicles. Both vehicles must have a complete CDC and damage data for one vehicle must be available. The algorithm computes the crush profile of the second vehicle by using damage length (if entered) and the damage extent coded in the CDC. Additional information (e.g. SMASH L, and offset distance) can be entered to improve the results.

<b>V1</b>	<b>V2</b>
Vehicles Specifications, Curb Weight	Vehicles Specifications, Curb Weight
Crush Profile (C <sub>1</sub> - C <sub>n</sub> ), Damage Length	Damage Length
CDC	CDC
Heading Angle and PDOF	Heading Angle
Size and Stiffness Category	Size and Stiffness Category

**Table of Weights To Be Used For Known Occupants With Unknown Weight**

For known occupants with unknown weights, use the occupant's age or age group in the table below to determine the appropriate weight to add.

**(All Weights Are In Kilograms based on 50<sup>th</sup> percentile for each age group)**

<b>Age (months)</b>	0-2	3-5	6-8	9-11
<b>Weight (Male)</b>	5.4	7.1	8.5	9.8
<b>Weight (Female)</b>	4.9	6.9	8.0	9.1

<b>Age (years)</b>	1	2	3	4	5	6	7	8	9	10	11	12	13	14
<b>Weight (Male)</b>	11.1	13.7	16	18.2	20.7	22.7	25.7	30.4	34.1	36.1	42.1	46.3	53	61
<b>Weight (Female)</b>	10.6	12.9	15	17.2	19.2	21.5	24.7	29.1	34.1	38.3	44.9	49.7	55.5	56.3

<b>Age (years)</b>	15	16	17	18	19	20-29	30-39	40-49	50-59	60-69	70-79	>=80
<b>Weight (Male)</b>	64	69.4	72.9	70.6	73.8	80.2	83.1	85.7	86.4	86.4	81.2	74.7
<b>Weight (Female)</b>	57.6	59.1	59.3	60.9	64.1	67.7	68.8	72.5	73.4	73.5	69.6	62.4



**Source of Information:**

Advanced Data from Vital and Health Statistics, Number 361, July 7, 2005. "Anthropometric Reference Data for Children and Adults: U.S. Population, 1999-2002", by Margaret A. McDowell, M.P.H., PhD; Cheryl D. Fryar, M.S.P.H.; Rosemarie Hirsch, M.D.; Cynthia L. Ogden, Ph.D., Division of Health and Nutrition Examination Surveys; U.S. Department of Health and Human Services, Centers for Disease Control and Prevention, National Center for Health Statistics.

The NASSMAIN WinSMASH program will automatically use the resultant C values for each event on which you select to run WinSMASH. Run the WinSMASH while on the CDC tab after the available damage data for the vehicle or vehicles involved in this event have been recorded. Highlight the CDC of the impact you want to run, then click on “Process” from the main menu at the top of the screen. Then click on “Run WinSMASH”. Next select the WinSMASH Calculation Type (Standard, Barrier, Missing Damage, or Pole) run using the following Delta V Decision Rules which are listed in order of precedence:

### **DELTA V, BARRIER EQUIVALENT AND SPEED ESTIMATE DECISION RULES**

1. If all information on the vehicle(s) is known, use the WinSMASH program Standard (for vehicle to vehicle) or Barrier (vehicle to object) calculation type. If the results look reasonable, complete the Delta-V variables of the CDC tab of the Exterior Vehicle (EV) Form including the Barrier Equivalent Speed (BES) using the results from WinSMASH. If the exact point of impact and final rest positions are known and entered in the WinSMASH, in addition to all vehicle damage information, the program uses the Damage and Trajectory algorithm and computes the Impact Speed. Use the results from WinSMASH to complete the Delta-V variables of the CDC tab of the Exterior EV Form including the Impact Speed and the Barrier Equivalent Speed (BES). Select the basis for Delta-V as “Damage and Trajectory Routine.”
2. If you have one inspected vehicle (complete CDC and crush profile) and one partially inspected vehicle, use the WinSMASH Standard calculation type entering all of the available information (e.g., CDC, WinSMASH L, Ds, estimated crush) on the partially inspected vehicle. If the results are reasonable, complete the Delta-V variables of the CDC tab of the EV Form including the Barrier Equivalent Speed using the results from WinSMASH. Since the Impact Speed was not calculated, leave it blank and the computer will put in **998**. Select the basis for Delta-V for both vehicles as “SMASH – Damage w/CDC only.” If results are **NOT** reasonable use rule #3 and treat the partially inspected vehicle as an unknown or missing vehicle.
3. If you have one complete inspected vehicle and one non-inspected vehicle, then use the WinSMASH Missing Vehicle calculation type. If the results are reasonable, complete the Delta-V variables of the CDC tab of the EV Form including the BES using the results from WinSMASH. Select the basis for Delta-V for both vehicles as “Missing Vehicle”. If the results look reasonable for the completely inspected vehicle, code the “Confidence level” on the General Vehicle (GV) Form, Delta-V tab as “Collision fits model – results appear reasonable.” If these results are high or low, code this and annotate the reason. The “Confidence Level” for the non-inspected vehicle will be precoded as “Borderline reconstruction ~ results look reasonable”.

4. For car-to-object impacts where the object moves or sustains damage (poles, trees, large trucks, or large animals etc.) or the object is struck (horizontally) during a rollover, use the WinSMASH damage routine and treat the object as a rigid barrier. If the results look reasonable code **only** the BES. Select the Basis for Total Delta-V as “Yielding Object”. To code BES only, type “999” in the total Delta V block; EDS will then prefill all Delta V variables except BES. You must then code the BES. For smaller non-fixed objects select Estimated Highest Delta-V as minor. Select the Basis for Total Delta-V as appropriate (e.g. “Yielding object”).
5. For vehicle-to-vehicle or vehicle-to-object impacts where a crush profile is roughly estimated or you only have a CDC for the vehicles involved (e.g., partially repaired vehicle, only have photos of damage, etc.), use the WinSMASH damage routine to get an estimated Delta-V. If the results look reasonable select the calculated Delta-V as a range in Estimated Highest Delta-V. Select the Basis for Total Delta-V as appropriate (e.g. “insufficient data”). **Side note** - the vehicle-to-object currently must be done in the stand-alone program.
6. For vehicle-to-object impact with a CDS applicable vehicle that cannot be adequately represented by the parameters in an acceptable reconstruction size/stiffness category (e.g., winch, non-standard bumper, etc.), referred to here as **altered vehicle**, use the WinSMASH damage routine to get an estimated Delta-V. If the results look reasonable, select the calculated Delta-V as a range in Estimated Highest Delta-V. If a crush profile cannot be obtained then select Estimated Highest Delta-V as Minor, Moderate, or Severe. Select the Basis for Total Delta-V as appropriate (e.g. “Vehicle is beyond scope”).
7. For vehicle-to-vehicle impacts where one of the vehicles is **altered** (see #6) use the WinSMASH damage routine to get an estimated Delta-V. Code BES only for unaltered vehicle and select the calculated Delta-V as a range in Estimated Highest Delta-V for **both** vehicles. If both vehicles are altered, then select the calculated Delta-V as a range in Estimated Highest Delta-V for both vehicles and do not code BES.
8. For cases where there are two or more significant impacts with overlapping or masking of damage such that individual crush profiles cannot be obtained then select the Basis for Total Delta-V as “Overlapping Damage” and select Estimated Highest Delta-V as Minor, Moderate, or Severe. **NOTE:** For vehicle-to-vehicle impacts where one vehicle is known and the other has masked damage as described above, treat the masked vehicle as a missing vehicle and follow rule number 3 instructions.
9. For sideswipe, severe override/underide, undercarriage, non-horizontal and rollover type impacts, select the Basis for Total Delta-V as appropriate (e.g. “Sideswipe”, “Non-horizontal”, etc.) and select Estimated Highest Delta-V as Minor, Moderate, or Severe

10. For cases where one vehicle has complete inspection and nothing is known about the other vehicle (PAR indicates a “sedan”) run Barrier option of WinSMASH. Code the BES and select the calculated Delta-V as a range in Estimated Highest Delta-V.

**Definitions for Minor, Moderate, or Severe:**

**Rollover** - damage assessment priority shall be given to passenger compartment.

***Top Plane***

Minor is used when there is surface scratching or dents; includes CDC extent zones 1 & 2.

Moderate is used when the passenger compartment maximum crush extends into CDC extent zone 3.

Severe is used when the passenger compartment maximum crush is greater than CDC extent zone 3.

***Side Plane***

Minor is used when there is surface scratching or dents with no passenger compartment intrusion.

Moderate is used when there is 25 cm (10 inches) or less passenger compartment intrusion.

Severe is used when there is greater than 25 cm (10 inches) passenger compartment intrusion.

**Swiping Type Impacts**

Minor is used when there is minor crush that does not result in passenger compartment intrusion.

Moderate is used when the maximum crush extends beyond the side door impact protection (*i.e.*, door beam) that can result in up to 25cm (10 inches) passenger compartment intrusion.

Severe is used when the maximum crush results in greater than 25 cm (10 inches) passenger compartment intrusion.

**Severe Override/underride Impacts**

Minor is used when only the hood/trunk and top of fenders are involved and there is no passenger compartment intrusion.

Moderate is used when only the hood/trunk and top of fenders are involved and there is minimal passenger compartment intrusion.

Severe is used when only the hood/trunk and top of fenders are involved and there is major passenger compartment intrusion.

**Undercarriage Impacts**

Minor is used when it is a swiping type impact with surface scratching or dents.

Moderate is used when modest crush or bending occurs.

Severe is used when significant crush or bending occurs.

**Overlapping (Masked) Impacts**

Minor is used when the maximum crush attributed to the most severe impact (estimate) is less than 10 cm.

Moderate is used when the maximum crush attributed to the most severe impact (estimate) is 10cm-35cm.

Severe is used when the maximum crush attributed to the most severe impact (estimate) is greater than 35cm.

**Other Non-Horizontal Impacts**

Minor is used when the maximum crush is less than 10 cm.

Moderate is used when the maximum crush is 10cm-35cm.

Severe is used when the maximum crush is greater than 35cm.

The NASSMAIN WinSMASH program will automatically use the resultant C values for each event on which to run WinSMASH. The WinSMASH while on the CDC tab after the available damage data for the vehicle or vehicles involved in this event has been recorded. Highlight the CDC of the impact, then click on "Process" from the main menu at the top of the screen. Then click on "Run WinSMASH".

**TOTAL DELTA V**

**Screen Name:** DELTA V–Total

**SAS Data Set:** *CDCCRS*

**SAS Variable:** *DVTOTAL*

**Oracle Name:** *VEHICLEDEFORMATION.TOTALDELTA V*

**Element Attributes:**

Generated kmph  
999 Unknown

**Range:** 1-160, 999

**Source:** WinSMASH program.

**Remarks:**

The Total Delta V is automatically generated by the NASSMAIN WinSMASH program for this impact.

The integrated WinSMASH program will automatically use the resultant C values for each event on which you select to run WinSMASH. Run the WinSMASH while on the CDC tab after the available damage data for the vehicle or vehicles involved in this event has been recorded. Highlight the CDC of the impact, then click on “Process” from the main menu at the top of the screen. Then click on “Run WinSMASH”. Next select the type of WinSMASH to run using the Delta V Decision Rules listed in the previous section.

**Unknown**

is used when the results for this impact are unobtainable or unreasonable.

**LONGITUDINAL DELTA V**

**Screen Name:** DELTA V -- Longtdl

**SAS Data Set:** *CDCCRSH*

**SAS Variable:** *DVLONG*

**Oracle Name:** *VEHICLEDEFORMATION.LONGDELTA V*

**Element Attributes:**

Generated kmph  
999 Unknown

**Range:** -160 - +160, 999

**Source:** WinSMASH program.

**Remarks:**

The Longitudinal Component of Delta V is automatically generated by the NASSMAIN WinSMASH program for this impact.

**LATERAL DELTA V**

**Screen Name:** DELTA V -- Lateral

**SAS Data Set:** *CDCCRSH*

**SAS Variable:** *DVLAT*

**Oracle Name:** *VEHICLEDEFORMATION.LATDELTA V*

**Element Attributes:**

Generated kmph  
999 Unknown

**Range:** -160 - +160, 999

**Source:** WinSMASH program.

**Remarks:**

The Lateral Component of Delta V is automatically generated by the NASSMAIN WinSMASH program for this impact.



**ENERGY ABSORPTION****Screen Name:** Energy**SAS Data Set:** *CDCCRS***SAS Variable:** *ENERGY***Oracle Name:** *VEHICLEDEFORMATION.ENERGYDELTA***Element Attributes:**

	Generated joules
9,999,999	Unknown

**Range:** 150 – 1,100,000, 9,999,999**Source:** WinSMASH program.**Remarks:**

Enter The Energy Absorption is automatically generated by the NASSMAIN WinSMASH program for this impact.

**IMPACT SPEED OR CHANGE TO IMPACT**

**Screen Name:** Impact

**SAS Data Set:** *CDCCRSH*

**SAS Variable:** *IMPACTSP*

**Oracle Name:** *VEHICLEDEFORMATION.IMPACTDELTA*

**Element Attributes:**

Generated kmph  
998 Damage and Trajectory run not made  
999 Unknown

**Range:** 1 – 160, 998, 999

**Source:** WinSMASH program — damage and trajectory routine

**Remarks:**

The Impact Speed is automatically generated by the NASSMAIN WinSMASH damage and trajectory program for this impact.

**BARRIER EQUIVALENT SPEED**

**Screen Name:** Barrier

**SAS Data Set:** *CDCCRS*

**SAS Variable:** *BAREQSP*

**Oracle Name:** *VEHICLEDEFORMATION.BARRIERDELTA*

**Element Attributes:**

Generated kmph  
999 Unknown

**Range:** 1-160, 999

**Source:** WinSMASH program.

**Remarks:**

The Barrier Equivalent speed is automatically generated by the NASSMAIN WinSMASH for this impact.

The BES is defined as the speed with which a vehicle would have to collide with a fixed barrier in order to absorb the same amount of energy or produce the same amount of crush as in this crash. The same energy absorption could come out of collisions with different delta-V's, leading to different potential injuries. BES, therefore, is a more appropriate way of comparing collisions with similar struck objects. The BES calculated using mass and energy absorbed by each vehicle. No information is required of the collision partner for BRS calculations. Whereas, the total amount of energy (both Vehicle 1 and Vehicle 2) is required to calculate the approach delta-V. For impacts between two similar vehicles, if the mass of one vehicle is significantly greater than its collision partner, then the delta-V equals the BES. Also, if the stiffness of one vehicle is significantly greater than the collision partner then the delta-V is proportional to their mass ratio and the BES.

**ESTIMATED SEVERITY**

**Screen Name:** Estimated

**SAS Data Set:** *CDCCRS*

**SAS Variable:** *DVEST*

**Oracle Name:** *VEHICLEDEFORMATION.ESTIMATEDDELTA V*

**Element Attributes:**

Oracle	SAS	
1	0	[Reconstruction delta V]
<b>Estimated Delta V</b>		
2	1	Less than 10 kmph
3	2	Delta V ≥ 10 kmph < 25 kmph
4	3	Delta V ≥ 25 kmph < 40 kmph
5	4	Delta V ≥ 40 kmph < 55 kmph
6	5	Delta V ≥ 55 kmph

**Other estimates of damage severities**

7	6	Minor
8	7	Moderate
9	8	Severe
10	9	Unknown

**Source:** Researcher determined.

**Remarks:**

Reconstruction delta V can not be selected, it is always generated by NASSMAIN when the Delta V variables are generated by the NASSMAIN WinSMASH.

The purpose of this variable is to record an estimate of the Delta V for those situations where the NASSMAIN WinSMASH program (including the Barrier Equivalent Speed) cannot be properly utilized (e.g., overlapping damage, crush profile not measured, severe underride/override, swiping, or rollover type impacts).

For car-to-car or car-to-object impacts where a crush profile is roughly estimated or you only have a CDC for all vehicles involved (e.g., partially repaired vehicle, only have photos of damage, etc.), use the WinSMASH damage routine to get an estimated Delta V. If the results look reasonable, then record the calculated Delta V as a range in the Estimated Highest Delta V. Record the Basis for Total Delta V as appropriate (e.g. insufficient data, etc).

For cases where there are two or more significant impacts with overlapping or masking of damage such that individual crush profiles cannot be obtained then record the Basis for Total Delta V as overlapping damage and record the Estimated Highest Delta V as minor, moderate or severe.

Minor, Moderate and Severe are defined below for different damage types:

**Rollover** — damage assessment priority shall be given to passenger compartment.

***Top Plane***

- |          |   |
|----------|---|
| Minor    | is used when there is surface scratching or dents; includes CDC extent zones 1 & 2.     |
| Moderate | is used when the passenger compartment maximum crush extends into CDC extent zone 3.    |
| Severe   | is used when the passenger compartment maximum crush is greater than CDC extent zone 3. |

***Side Plane***

- |          |  |
|----------|--|
| Minor    | is used when there is surface scratching or dents with no passenger compartment intrusion. |
| Moderate | is used when there is 25 cm or less passenger compartment intrusion.                       |
| Severe   | is used when there is greater than 25 cm passenger compartment intrusion.                  |

**Swiping Type Impacts**

- |          |   |
|----------|---|
| Minor    | is used when there is minor crush that does not result in passenger compartment intrusion.  |
| Moderate | is used when the maximum crush extends beyond the side door impact protection ( <i>i.e.</i> , door beam) that can result in up to 25cm passenger compartment intrusion. |
| Severe   | is used when the maximum crush results in greater than 25cm passenger compartment intrusion.  |

**Severe Override/underride Impacts**

- |          |  |
|----------|--|
| Minor    | is used when only the hood/trunk and top of fenders are involved and there is no passenger compartment intrusion.      |
| Moderate | is used when only the hood/trunk and top of fenders are involved and there is minimal passenger compartment intrusion. |
| Severe   | is used when only the hood/trunk and top of fenders are involved and there is major passenger compartment intrusion.   |

**Undercarriage Impacts**

Minor	is used when it is a swiping type impact with surface scratching or dents.
Moderate	is used when modest crush or bending occurs.
Severe	is used when significant crush or bending occurs.

**Overlapping (Masked) Impacts**

Minor	is used when the maximum crush attributed to the most severe impact (via estimate) is less than 10cm.
Moderate	is used when the maximum crush attributed to the most severe impact (via estimate) is 10cm -35cm.
Severe	is used when the maximum crush attributed to the most severe impact (via estimate) is greater than 35cm.

**Other Non-Horizontal Impacts**

Minor	is used when the maximum crush is less than 10 cm.
Moderate	is used when the maximum crush is 10cm -35cm.
Severe	is used when the maximum crush is greater than 35cm.

**Other Non-Horizontal Impacts**

Minor	is coded when the maximum crush is less than 10 cm .
Moderate	is coded when the maximum crush is 10cm -35cm.
Severe	is coded when the maximum crush is greater than 35cm.

**SEVERITY RANK**

**Screen Name:** Rank

**SAS Data Set:** *CDCCRS*

**SAS Variable:** *RANK*

**Range:** 1-29

**Element Attributes:**  
As selected

**Source:** Researcher determined

**Remarks:**

Indicate the **Rank** for the event that resulted in the severity that has been coded. If a Delta V, Barrier Equivalent Speed, or estimate is known, than the **Rank** of the event must be entered.

If the vehicle is involved in multiple impacts/events, corresponding Events are ranked in order of highest crash severity, based on energy management and the amount of reduction of occupant space for non-collision events.

Use the NASSMAIN WinSMASH results, barrier equivalent speeds, and severity estimates to help rank Events.

Multiple impacts the highest delta-V is only ranked. Rank 1 equals the highest delta-V.

Unknown is not used.

**BASIS FOR DELTA V ENTRY**

**Screen Name:** Basis

**SAS Data Set:** CDCCRSH

**SAS Variable:** DVBASIS

**Element Attributes:**

**Delta V Calculated**

- 1 WinSMASH - Damage only
- 2 WinSMASH - Damage and trajectory
- 3 WinSMASH - Missing vehicle
- 4 WinSMASH - Damage with CDC only

**Delta V Not Calculated**

- 5 At least one vehicle is beyond the scope of SMASH
- 6 Rollover
- 7 Other non-horizontal forces
- 8 Sideswipe type damage
- 9 Severe override
- 10 Yielding object
- 11 Overlapping damage
- 12 Insufficient data (specify):
- 98 Other (specify):

**Source:** Researcher determined — inputs include WinSMASH output (if applicable), vehicle inspection, scene inspection, police report, and photographs.

**Remarks:**

This variable is used to indicate: (1) which NASSMAIN WinSMASH program or routine was used to compute this vehicle's highest delta V or (2) the reason a NASSMAIN WinSMASH program was not applied to the most severe impact.

**Delta V Calculated**

**NASSMAIN WinSMASH - Damage and trajectory**

The NASSMAIN WinSMASH output is based on trajectory evidence documented at the scene, in addition to complete vehicle damage data.

**NASSMAIN WinSMASH - Damage only**

The WinSMASH output is based upon complete vehicle damage only.



**NASSMAIN WinSMASH - Missing vehicle**

In a two vehicle impact only one vehicle is inspected (damage measurements and CDC obtained), and for the other vehicle, the damage measurements (including CDC) are missing; however, enough data are available to use the WinSMASH Missing Vehicle option.

**WinSMASH - Damage with CDC only**

The WinSMASH output is based on a two vehicle collision with insufficient vehicle damage documentation. The two vehicle collision must include: one complete vehicle inspection and the other vehicle must have a complete CDC. Additional crush profile information such as the WinSMASH L, "D", etc may be entered to improve the results.

**Delta V Not Calculated****At least one vehicle is beyond the scope of SMASH**

One of the vehicles (which may be this vehicle) involved in this impact cannot be **adequately represented** by the parameters in an acceptable reconstruction size/stiffness category (e.g., large truck, motorcycle, bus, etc.). As a general rule in CDS NASS, any vehicle that is not applicable for a CDC is not applicable for the NASSMAIN WinSMASH program.

**For the following codes:** All vehicles within scope (CDC applicable) of WinSMASH program but one of the collision conditions is beyond the scope of the WinSMASH program or other acceptable reconstruction techniques, regardless of the adequacy of damage data.

**Rollover**

The involved vehicle fits the vehicle parameters for an acceptable WinSMASH program; however, the rollover collision is beyond the scope of the program.

**Other non-horizontal force**

The involved vehicle fits the vehicle parameter for an acceptable WinSMASH program; however, the other non-horizontal force is beyond the scope of the program (e.g., large object falling on vehicle).

**Sideswipe type damage**

The involved vehicle fits the vehicle parameters for an acceptable WinSMASH program; however, the sideswipe type of collision is beyond the scope of the program.

**Severe override**

The involved vehicle fits the vehicle parameters for an acceptable WinSMASH program; however, the severe override type of collision is beyond the scope of the program.

**Yielding object**

The involved vehicle fits the vehicle parameters for an acceptable WinSMASH program; however, the collision with a yielding object (e.g., sheared utility pole) is beyond the scope of the program.

Basis for Delta V Entry (cont'd)

Page 3 of 3

**Overlapping damage**

The involved vehicle fits the vehicle parameters for an acceptable WinSMASH program; however, collisions involving overlapping damage (i.e., multiple impacts in the same area) are beyond the scope of the program.

**Insufficient data (specify)**

The involved vehicles and the collision type are applicable for an acceptable WinSMASH program, but due to insufficient data on one or both of the vehicles or object, an acceptable WinSMASH program cannot be used.

**Other (specify):**

The Delta V could not be calculated for a reason not identified in the current pick list. The reason must be specified on the line provided.

LIST

The screenshot shows a software window titled "Exterior Vehicle Form, Case 2007-996-900015/ Vehicle #2". The window has a menu bar with options: VEHICLE, TIRE, SPECIFICATIONS, FUEL, FIRE, CRUSH, CDC, EDR, SKETCHES, LOG, and REVIEW. Below the menu bar, there is a dropdown menu for "EDR Information obtained?" with the selected option "Yes - Data entered". Below this, there are tabs for LIST, EDR, AIR BAG DEPLOY, PRECRASH, and CRASH. The "LIST" tab is active, showing a table with two columns: "Deploy Status" and "CDC". The table has one row with an asterisk (\*) in the "Deploy Status" column. At the bottom right of the window, there are "Save" and "Close" buttons.

EDR information will be entered whenever an EDR is read by the field researcher or by other personnel who provide information from the EDR to the researcher.

Information will be entered for as many events as the EDR has recorded. The event may be a deployment event, a near deployment event, or neither (just information from the latest ignition cycle).

ONE VALUE WILL BE TAKEN FOR EACH EDR/EVENT  
THERE MAY BE MORE THAN ONE EDR/EVENT PER EDR READING  
THERE MAY BE MORE THAN EDR/EVENT PER CDC/EVENT

**SEE THE  
EVENT DATA RECORDER DATA COLLECTION GUIDELINE  
FOR ADDITIONAL INSTRUCTIONS.**

**FOR DIRECT IMPORT OF EDR DATA SEE THE CDR-to-XML  
LIBRARY INSTALLATION & BASIC FUNCTIONS GUIDELINE**

EDR

Exterior Vehicle Form, Case 2011-48-070F/ Vehicle #1

VEHICLE | TIRE | SPECIFICATIONS | FUEL | FIRE | CRUSH | CDC | EDR | SKETCHES | LOG | REVIEW

EDR Information obtained ? Yes - Data entered

LIST | EDR | AIR BAG DEPLOY | PRECRASH | CRASH

Identifiers

EDR Version	1.1	Complete File Recorded	Yes
Lamp Status	On	Multi-Event, Number of Events	3 or more
CDC	Event# 1- 01F9E999	Time from Event 1 to 2	5 s
Deploy Status	Deployment	Imaging Method	DLC

Ignition Cycle

Event	5	Investigation	5
-------	---	---------------	---

Driver

Belt	Buckled
Pretensioner	4 ms
Seat Track Forward	Yes

Passenger

Belt	Unbuckled
Seat	Not Reported
Pretensioner	5 ms
Suppression Switch	Air Bag not suppressed

Save Close

**EDR**

**Screen Name:** EDR information obtained?

**SAS Data Set:** *GV*

**SAS Variable:** *EDRINFO*

**Oracle Name:** *VEHICLE.EDREXIST*

**Element Attributes:**

Oracle	SAS	
2	1	Yes - Data entered
10	10	EDR information not obtained - Vehicle make/model not supported by software or hardware.
7	4	EDR information not obtained - Vehicle damage prevents accessing EDR data.
8	5	EDR information not obtained - Permission not received (specify)
5	7	EDR information not obtained - EDR submitted to manufacturer
11	11	EDR information not obtained - Other reasons (specify)
12	12	EDR information not obtained - Software issue (specify)
13	13	EDR information not obtained - Hardware issue (specify)
	77	[Vehicle not inspected]
	88	[Not a CDS vehicle]
-9999	99	Unknown

**Source:** Researcher determined, vehicle inspection

**Remarks:**

Record all deployment and/or non-deployment events that are stored. Assign each to a listed event, i.e., Choose event number from list, Event not related to this crash or Unknown in Accident Event Sequence Number.

**Yes - Data entered**

is used when the researcher obtains data from the EDR.

**EDR information not obtained - Vehicle make/model not supported by software**

is used when the researcher determines that this vehicle is not supported by the commercially available software/hardware.

**EDR information not obtained - Vehicle damage prevents accessing EDR data**

is used when the researcher determines the vehicle is equipped with and EDR supported by the commercially available software/hardware and the vehicle has been damaged so that:

EDR information obtained? (cont'd)

Page 2 of 3

- The electrical system is compromised so that the researcher cannot access necessary connections, i.e., the on-board diagnostic (OBD) plug is damaged or induced damage prevents access to the OBD  
and
- Vehicle damage prevents access to the control module

**Photo documentation of the damage must be provided.****EDR information not obtained - Permission not received (specify)**

is to be used if the EDR equipped vehicle is supported by the commercially available software/hardware and the researcher was refused permission to access or image the data from the EDR. Also, use this attribute if permission was not granted to cause further damage to the vehicle to gain access.

**EDR information not obtained - EDR submitted to manufacturer**

use this when any module of any make/model of vehicle is submitted to the manufacturer for imaging. This attribute should be updated when module data is received.

**EDR information not obtained - Other reasons (specify)**

This is to be used only if the vehicle is equipped with an EDR supported by the commercially available software/hardware AND the other attributes do not apply. Please specify the reason.

**EDR information not obtained - Software issue (specify)**

This is to be used only if the vehicle is equipped with an EDR supported by the commercially available software AND

- all necessary connections to the vehicle were made and
- the software indicates an error, such as:
  - translation error or
  - no communication to the air bag module

EDR information obtained? (cont'd)

Page 3 of 3

**EDR information not obtained - Hardware issue (specify)**

This is to be used only if the vehicle is equipped with an EDR supported by the commercially available software AND a problem arises in making the necessary connections to the vehicle.

Examples:

- cable to the on-board diagnostic plug (OBD) will not fit
- no power to the EDR or
- the cable to the module does not fit.

**Unknown**

This is to be used only if the vehicle is equipped with an EDR supported by the commercially available software/hardware and the EDR couldn't be imaged. Unknown is defined as the researcher couldn't obtain the EDR data due to the status of the control module being unknown.

Examples:

- module not in vehicle
- module replaced, i.e., current module in vehicle is not the same one as involved in the crash.

**CDR/EDR VERSION NUMBER**

**Screen Name:** EDR Version

**SAS Data Set:** *EDRDATA*

**SAS Variable:** *EDRVER*

**Oracle Name:** *ERDATA.EDRVERSION*

**Element Attributes:**

Specify version of software being used

Copy of EDR information provided by third party (specify)

**Source:** Commercially available software program/researcher

**Remarks:**

The minimum known information if an EDR is read by the researcher will be the EDR software version being used.

**Specify version of software being used**

Various versions of software for various makes/models of vehicles may be in use. Enter the version that was used to read the EDR in this vehicle.

**Copy of EDR information provided by third party**

If the EDR was read by a third party (vehicle manufacturer, etc.) and only a hard copy is supplied indicate the source of the information.



**WARNING LAMP STATUS**

**Screen Name:** Lamp Status

**SAS Data Set:** *EDRDATA*

**SAS Variable:** *LAMPSTAT*

**Oracle Name:** *EDRDATA.SIRLAMPSTATUSID*

**Element Attributes:**

Oracle	SAS	
1	1	On
2	2	Off
-8886	8	Not reported
-9999	9	Unknown
-7778		[Invalid]

**Source:** As recorded by the commercially available software program.

**Remarks:**

**On**

The EDR indicates that the supplemental restraint system, warning lamp is on.

**Off**

The EDR indicates that the supplemental restraint system warning lamp is off

**Not reported**

The information is not reported by the EDR

**Unknown**

The information is not known

**ACCIDENT EVENT SEQUENCE NUMBER**

**Screen Name:** CDC

**SAS Data Set:** *EDRDATA*

**SAS Variable:** *EACCSEQ*

**Oracle Name:** *EDRDATA.CDCID*

**Element Attributes:**

Oracle	SAS	
		Choose event number from drop down list
-8887	97	Event not related to this crash
-8879	98	Not reported
-9999	99	Unknown

**Source:** Researcher determined

**Remarks:**

If an exact determination can not be made when attempting to assign an event to a non deployment or deployment event then **Unknown** should be selected. Choose the event if it has been established beyond any doubt that the non-deployment or deployment is related.

**Choose event number from drop down list**

Choose from the list of events previously listed for this vehicle.

**Event not related to this crash**

If there is a recorded event not related to this crash.

**Unknown**

If a positive determination cannot be made as to which event the EDR data is associated, select this attribute.

**TYPE OF EVENT**

**Screen Name:** Deploy Status

**SAS Data Set:** *EDRDATA*

**SAS Variable:** *DPLYSTAT*

**Oracle Name:** *EDRDATA.DEPLOYSTATUSID*

**Element Attributes:**

Oracle	SAS	
1	1	Non-Deployment
2	2	Deployment
3	8	Not reported

**Source:** Researcher determined

**Remarks:**

Choose attribute based upon EDR output.

**Screen Name:** Complete File Recorded

**SAS Data Set:**

**SAS Variable:**

**Oracle Name:** *EDRDATA.COMPLETEFILEID*

**Element Attributes:**

Oracle	SAS	
1	1	Yes
0	0	No
7	7	Not reported

**Source:** As recorded by the commercially available software program.

**Remarks:**

**Yes**

The EDR indicates that the file was recorded.

**No**

The EDR indicates that the file was not completely recorded.

**Not reported**

The information is not reported by the EDR

**EXTERIOR VEHICLE FORM**  
**MULTI-EVENT, NUMBER OF EVENTS**

**EDR**

**Screen Name:** Multi-Event, Number of Events

**SAS Data Set:**

**SAS Variable:**

**Oracle Name:** *EDRDATA.NUMBEREVENTSID*

**Element Attributes:**

Oracle	SAS	
1	1	1
2	2	2
3	3	3 or more
7	7	Not reported

**Source:** As recorded by the commercially available software program.

**Remarks:**

Event means a crash or other physical occurrence that causes the trigger threshold to be met or exceeded, or an air bag to be deployed, whichever occurs first.

Multi-event crash means the occurrence of more than one event, the first and last of which began not more than 5 seconds apart. If a module records 3 or more events, indicate by selecting 3 or more.

**1**  
Equals one event as indicated by the EDR.

**2**  
Equals two events as indicated by the EDR.

**3 or more**  
is used if the EDR recorded 3 or more events.

**Not reported**  
The information is not reported by the EDR

**Screen Name:** Time from Event 1 to 2

**SAS Data Set:**

**SAS Variable:**

**Oracle Name:** *EDRDATA.EVENTINTERVAL*

**Element Attributes:**

Oracle	SAS	
-7777	7	No Second Event Enter the time in milliseconds
-8886	8	Not reported

**Source:** As recorded by the EDR from the commercially available software program.

**Range:** 0 – 5,000

**Remarks:**

This indicates the elapsed time from time zero of the first event to time zero of the second event.

**No Second Event**

No second event was recorded by the EDR.

**Not reported**

The information is not reported by the EDR

**Screen Name:**           **Imaging Method**

*SAS Data Set:*

*SAS Variable:*

*Oracle Name:*           **EDRDATA.IMAGINGMETHODID**

**Element Attributes:**

Oracle	SAS	
1	1	DLC
2	2	Direct to Module
3	3	Third Party

**Source:**                    Researcher determined, vehicle inspection.

**Remarks:**

Choose the attribute that describes the method that was used to image the EDR data.

**DLC (Diagnostic Link Connector)**

The commercially available hardware is connected to the DLC port also known as the OBD (On-Board Diagnostics) port.

**Direct to Module**

The commercially available hardware is directly connected to the control module.

**Third Party**

The image was supplied by the manufacturer, law enforcement, insurance companies or any other third party.

**NUMBER OF IGNITION CYCLES AT EVENT OCCURRENCE**

**Screen Name:** Ignition Cycle Event

**SAS Data Set:** *EDRDATA*

**SAS Variable:** *EVCYCLES*

**Oracle Name:** *EDRDATA.EVENTIGNITIONCYCLES*

**Element Attributes:**

Oracle SAS

Enter the number of cycles

-8879 999998 Not reported

-9999 999999 Unknown

**Source:** As recorded by the EDR from the commercially available software program.

**Remarks:**

Identifies how many times the ignition has been cycled on and off.



**NUMBER OF IGNITION CYCLES AT INVESTIGATION**

**Screen Name:** Ignition Cycle Investigation

**SAS Data Set:** *EDRDATA*

**SAS Variable:** *INVCYCLE*

**Oracle Name:** *EDRDATA.INVESTIGNITIONCYCLE*

**Element Attributes:**

Oracle	SAS	
		Enter the number of cycles
-8879	999998	Not reported
-9999	999999	Unknown

**Source:** As recorded by the EDR from the commercially available software program.

**Remarks:**

The number of ignition cycles when the module was imaged for this report.

**EXTERIOR VEHICLE FORM**  
**DRIVER'S BELT STATUS**

**EDR**

**Screen Name:** Driver Belt

**SAS Data Set:** *EDRDATA*

**SAS Variable:** *DRVBELT*

**Oracle Name:** *EDRDATA.DRIVERBELTID*

**Element Attributes:**

Oracle	SAS	
1	1	Buckled
2	2	Unbuckled
-8886	8	Not reported
-9999	9	Unknown

**Source:** As recorded by the EDR from the commercially available software program.

**Remarks:**

Records if the driver's restraint buckle was engaged in the latch.

**TIME FOR DRIVER PRETENSIONER ACTUATION**

**Screen Name:** Pretensioner

**SAS Data Set:** *EDRDATA*

**SAS Variable:** *DRPRTEN*

**Oracle Name:** *EDRDATA.PRETENSEDEPLOYTIME*

**Element Attributes:**

Oracle	SAS	
		Enter the time in milliseconds
-8885	85	Not deployed
-8879	86	Not reported
-9999	99	Unknown

**Source:** As recorded by the EDR from the commercially available software program.

**Range:** 1-84, 85, 86, 99

**Remarks:**

Records the time in milliseconds after algorithm enabled that the Pretensioner actuated.

**DRIVER SEAT TRACK IN FORWARD POSITION**

**Screen Name:**           Seat Track Forward

**SAS Data Set:**         ***EDRDATA***

**SAS Variable:**        ***DRIVSEAT***

**Oracle Name:**        ***EDRDATA.DRIVERSEATID***

**Element Attributes:**

Oracle	SAS	
1	1	Yes
2	2	No
3	8	Not reported
-9999	9	Unknown

**Source:**           As recorded by the EDR from the commercially available software program.

**Remarks:**

Records if the seat track adjustment was forward of a predetermined point in its travel.

**PASSENGER'S BELT STATUS**

**Screen Name:** Passenger Belt

**SAS Data Set:** *EDRDATA*

**SAS Variable:** *PASBELT*

**Oracle Name:** *EDRDATA.PASSBELTID*

**Element Attributes:**

Oracle	SAS	
1	1	Buckled
2	2	Unbuckled
-8886	8	Not reported
-9999	9	Unknown

**Source:** As recorded by the EDR from the commercially available software program.

**Remarks:**

Records if the passenger's restraint buckle was engaged in the latch.

**PASSENGER'S SEAT WEIGHT SENSOR POSITION**

**Screen Name:** Passenger Seat

**SAS Data Set:** *EDRDATA*

**SAS Variable:** *PASSSEAT*

**Oracle Name:** *EDRDATA.PASSSEATID*

**Element Attributes:**

Oracle	SAS	
1	1	On
2	2	Off
3	8	Not reported
-9999	9	Unknown

**Source:** As recorded by the EDR from the commercially available software program in Occupant Classification Status

**Remarks:**

IF THE VEHICLE WAS EQUIPPED WITH OCCUPANT WEIGHT SENSING TECHNOLOGIES, THE SYSTEM MAY RECORD THE DATA RELATIVE TO THIS VARIABLE.

**TIME FOR PASSENGER PRETENSIONER ACTUATION**

**Screen Name:** Passenger Pretensioner

**SAS Data Set:** *EDRDATA*

**SAS Variable:** *PASPRTEN*

**Oracle Name:** *EDRDATA.PASPRETENSEDEPLOYTIME*

**Element Attributes:**

Oracle	SAS	
		Enter the time in milliseconds
-8885	85	Not deployed
-8879	86	Not reported
-9999	99	Unknown

**Source:** As recorded by the EDR from the commercially available software program.

**Range:** 1-84, 85, 86, 99

**Remarks:**

Records the time in milliseconds after algorithm enabled that the Pretensioner actuated.

**PASSENGER AIR BAG SUPPRESSION SWITCH POSITION**

**Screen Name:** Passenger Suppression Switch

**SAS Data Set:** *EDRDATA*

**SAS Variable:** *PSWSTAT*

**Oracle Name:** *EDRDATA.PSWITCHSTATUSID*

**Element Attributes:**

Oracle	SAS	
1	1	Not suppressed
2	2	Suppressed
-8886	8	Not reported
-9999	9	Unknown

**Source:** As recorded by the EDR from the commercially available software program.

**Remarks:**

Documents the presence of a passenger's air bag cut off switch and its position.



**AIR BAG DEPLOYMENT TIMES**

Exterior Vehicle Form, Case 2007-996-900015/ Vehicle #2

VEHICLE | TIRE | SPECIFICATIONS | FUEL | FIRE | CRUSH | CDC | EDR | SKETCHES | LOG | REVIEW

EDR Information obtained ? Yes - Data entered

LIST | EDR | AIR BAG DEPLOY | PRECRASH | CRASH

Air Bag Deployment Times

Type	Position	Stage 1 (ms)	Stage 2 (ms)
------	----------	--------------	--------------

Save Close

**AIR BAG DEPLOYMENT TIMES**

Air Bag Location

**Screen Name:** Type

**SAS Data Set:** *EDRABAG*

**SAS Variable:** *EBAGLOC*

**Oracle Name:** *AIRBAGDEPLOYTIME.AIRBAGID*

**Element Attributes:**

Oracle	SAS	
1	1	Steering Wheel Hub
2	2	Top Instrument Panel
3	3	Mid Instrument Panel
4	4	Bottom Instrument Panel
5	5	Seat Back
8	6	Door/Panel
9	7	Roof Side Rail
10	98	Other (specify)
11	99	Unknown

**Source:** EDR

**Remarks:**

Enter the location of the air bag. If air bags are available for the occupant, indicate the information on all air bags. Do so by inserting another air bag. To insert another air bag go to the menu bar and select **Edit/Insert**, then indicate its location, and complete the information about the air bag.

**Steering Wheel**

is used for an air bag that is designed to deploy from a module integrated with the steering wheel. It is designed to protect the vehicle's driver primarily from frontal impacts.

**Top Instrument Panel**

is used for those air bags that deploy rearward from a location on the top of the instrument panel. They are designed to protect front seat passengers primarily from frontal impacts.

**Mid Instrument Panel**

is used for those air bags that deploy rearward from a location in the middle of the instrument panel. They are designed to protect front seat passengers primarily from frontal impacts.

**Bottom Instrument Panel**

is used for those air bags that deploy rearward from a location in the bottom of the instrument panel. They are designed to protect front seat passengers primarily from frontal impacts. This includes "knee bags".

**Seat Back**

is located on the outside portion of the seat back and is designed to protect the torso of occupants primarily from side impacts.

**Seat Cushion**

is located on the outside portion *of* the seat cushion and is designed to protect the torso of occupants primarily from side impacts.

**Pillar (A or B)**

is primarily a tubular shaped bag that is tethered at the A pillar and is stored in the roof side rail and is designed to protect the head of occupants primarily from side impacts

**Door/Panel**

is located in the door/panel and is designed to protect the torso of occupants primarily from side impacts.

**Roof Side Rail**

is primarily a curtain type bag that is stored in the roof side rail and is designed to protect the head of occupants primarily from side impacts

**Other (specify)**

is used when the location of the air bag cannot be captured in the above attributes. This should be a rare occurrence. The location of the air bag must be specified.

**AIR BAG DEPLOYMENT TIMES**

Position

**Screen Name:** Position

**SAS Data Set:** *EDRABAG*

**SAS Variable:** *POSITION*

**Oracle Name:** *AIRGABDEPLOYTIME.POSITIONID*

**Element Attributes:**

Oracle	SAS	
1	1	Driver
2	2	Passenger

**Source:** EDR

**Remarks:**

**AIR BAG DEPLOYMENT TIMES**

Time For First Stage Air Bag Deployment

**Screen Name:** First Stage

**SAS Data Set:** *EDRABAG*

**SAS Variable:** *STAGE1*

**Oracle Name:** *AIRBAGDEPLOYTIME.STAGE1*

**Element Attributes:**

Oracle	SAS	
		Enter the time in milliseconds
-8885		Not Deployed
		Disposal
-9999	999	Unknown
-8880		Stage Not Reported

**Source:** As recorded by the EDR from the commercially available software program.

**Range:** 0-120, 999

**Remarks:**

This is the time in milliseconds after the algorithm enabled documenting when the air bag deployed. Vehicles that are equipped with multi-stage inflators will record the time after algorithm enabled when each stage fires or is disposed.

**AIR BAG DEPLOYMENT TIMES**

Time For Second Stage Air Bag Deployment

**Screen Name:** Second Stage

**SAS Data Set:** *EDRABAG*

**SAS Variable:** *STAGE2*

**Oracle Name:** *AIRBAGDEPLOYTIME.STAGE2*

**Element Attributes:**

Oracle	SAS	
	995	Enter the time in milliseconds [S]
	996	Disposal
-8885	997	Not Deployed
-9999	999	Unknown
-8880		Stage Not Reported

**Source:** As recorded by the EDR from the commercially available software program.

**Range:** 0-120, 996,997,999

**Remarks:**

This is the time in milliseconds after the algorithm enabled documenting when the air bag deployed. Vehicles that are equipped with multi-stage inflators will record the time after algorithm enabled when each stage fires or is disposed.

DATA

Exterior Vehicle Form, Case 2007-996-900015/ Vehicle #2

VEHICLE | TIRE | SPECIFICATIONS | FUEL | FIRE | CRUSH | CDC | EDR | SKETCHES | LOG | REVIEW

EDR Information obtained ? Yes - Data entered

LIST | EDR | AIR BAG DEPLOY | PRECRASH | CRASH

DATA

Pre-Seconds	Speed (MPH)	Engine Speed (RPM)	Throttle %	Brake Switch Circuit Status
	-5			
	-4			
	-3			
	-2			
*	-1			

Deploy Status Deployment

Save Close

**NUMBER OF SECONDS PRIOR TO CRASH**

**Screen Name:** Pre-Seconds

**SAS Data Set:** *EDRPRECR*

**SAS Variable:** *PRESEC*

**Oracle Name:** *EDR\_PRECRASH.PRESECONDS*

**Element Attributes:**

Enter insert a new entry

**Source:** As recorded by the EDR from the commercially available software program.

**Range:** -5,-4,-3,-2,-1/-10, -8, -6, -4, -2/-2.5, -2.0, -1.5, -1.0,-.5

**Remarks:**

If recorded, there are five precrash readings at two second, one second or half second intervals.



**PRECRASH VEHICLE SPEED READING**

**Screen Name:** Speed

**SAS Data Set:** *EDRPRECR*

**SAS Variable:** *SPEED*

**Oracle Name:** *EDR\_PRECRASH.SPEED*

**Element Attributes:**

Oracle	SAS	
		Enter the precrash speed reading (mph)
-8879	998	Not reported
-9999	999	Unknown

**Source:** As recorded by the EDR from the commercially available software program.

**Range:** 0-120

**Remarks:**

If recorded, there are five precrash speed readings at two second, one second or half second intervals.

**PRECRASH ENGINE SPEED READING**

**Screen Name:** Engine Speed

**SAS Data Set:** *EDRPRECR*

**SAS Variable:** *RPM*

**Oracle Name:** *EDR\_PRECRASH.RPM*

**Element Attributes:**

Oracle	SAS	
		Enter the precrash engine speed reading (rpm)
-8879	9998	Not reported
-9999	9999	Unknown

**Source:** As recorded by the EDR from the commercially available software program.

**Range:** 0-10,000 rpm

**Remarks:**

If recorded, there are five precrash engine speed readings at two second, one second or half second intervals.

**PRECRASH THROTTLE PERCENTAGE READING**

**Screen Name:** Throttle %

**SAS Data Set:**

**SAS Variable:**

**Oracle Name:** *EDR\_PRECRASH.THROTTLE*

**Element Attributes:**

Oracle	SAS	
		Enter the precrash throttle percentage reading
-8879	9998	Not reported
-9999	9999	Unknown

**Source:** As recorded by the EDR from the commercially available software program.

**Range:** 0-100%

**Remarks:**

If recorded, there are five precrash throttle percentage readings at two second, one second or half second intervals.

**PRECRASH BRAKE STATUS**

**Screen Name:** Brake Switch Circuit Status

**SAS Data Set:** *EDRPRECR*

**SAS Variable:** *BRKSWTCH*

**Element Attributes:**

Oracle	SAS	
1	1	On
2	2	Off
-8886	8	Not reported
-9999	9	Unknown

**Source:** As recorded by the EDR from the commercially available software program.

**Remarks:**

If recorded, there are five precrash brake switch circuit status at two second, one second or half second intervals.

DATA/LONGITUDINAL DELTA V

Exterior Vehicle Form, Case 2007-996-900015/ Vehicle #2

VEHICLE | TIRE | SPECIFICATIONS | FUEL | FIRE | CRUSH | CDC | EDR | SKETCHES | LOG | REVIEW

EDR Information obtained ? Yes - Data entered

LIST | EDR | AIR BAG DEPLOY | PRECRASH | CRASH

DATA

LONGITUDINAL DELTA V | LATERAL DELTA V

Time (ms)	Delta-V (MPH)
10	

Save Close

**DATA/LONGITUDINAL DELTA V**

[Number of Milliseconds After Crash]

**Screen Name:** N/A

**SAS Data Set:** *EDRCRASH*

**SAS Variable:** *MSECONDS*

**Oracle Name:** *EDR\_CRASH.SECONDS*

**Element Attributes:**

The unit of time for the delta V readings in milliseconds.

**Source:** As recorded by the EDR from the commercially available software program.

**Range:** 10-300, by 10's

**Remarks:**

Edit/Insert a new reading at 10 millisecond intervals.

**DATA/LONGITUDINAL DELTA V**

[Delta V Reading]

**Screen Name:** N/A

**SAS Data Set:** *EDRCRASH*

**SAS Variable:** *DELTA V*

**Oracle Name:** *EDR\_CRASH.DELTAV*

**Element Attributes:**

Oracle	SAS	
		The value of the delta V
-9999	999	Unknown

**Source:** As recorded by the EDR from the commercially available software program.

**Range:** -120 to -.1, 999. Add units in MPH

**Remarks:**

Enter only as many lines as times reported.

**DATA/LATERAL DELTA V**

Time for LATERAL Delta V reading

**Screen Name:** Time

**SAS Data Set:** N/A

**SAS Variable:** N/A

**Oracle Name:** *EDR\_CRASH.SECONDS*

**Element Attributes:**

Edit/Insert a new reading at 10 millisecond intervals

**Source:** As recorded by the EDR from the commercially available software program.

**Remarks:**



**DATA/LATERAL DELTA V**

Lateral Delta V reading

**Screen Name:** Delta-V

**SAS Data Set:** N/A

**SAS Variable:** N/A

**Oracle Name:** *EDR\_CRASH.DELTAV*

**Element Attributes:**

Enter Lateral Delta V reading  
Unknown

**Source:** As recorded by the EDR from the commercially available software program.

**Remarks:**

Insert the Delta V reading at 10 millisecond intervals.

**INSTRUCTIONS FOR COMPLETION OF VEHICLE DAMAGE SKETCH**

The Vehicle Sketch enables researchers to report data that are not encoded and might otherwise be omitted from the case. Pertinent data such as scrapes, scratches, buckling, paint transfers, and other indications of engagement or relative motion are reported on this page. In addition, sketch the vehicle damage profile on the outlines provided, using the established protocol as below.

- Outline the damage profile produced by the impact.
- Use cross hatches to indicate direct damage.
- Highlight induced damage and/or remote buckling with diagonal lines.

Although researchers are reporting a vehicle's crash related damage, other damage may be observed which existed prior to the crash or is towing damage. This type of damage must also be indicated and annotated accordingly.

Relevant measurements are required on the Vehicle Sketch page in order to support other data elements.

CDC extent zone measurements are required; although, only the measurements which pertain to the damaged plane are needed (*i.e.*, hood length for frontal, side extents for side impacts, etc.). Obtain all measurements which may be needed when questions arise regarding the damaged plane. If doubt exists concerning whether an impact is to a front or a side plane, obtain both front and side extent zone measurements.

In addition, front and back precrash bumper height measurements must be obtained for vehicles sustaining any end plane impact with another vehicle (in-transport or not in-transport) [*i.e.*, column (3) of CDC (including nonselected CDCs) must equal "F" or "B"].

- Measure from the bottom of the bumper face (reinforcement bar) to the ground.
- Include a calibrated instrument (contour gauge rod or 1 meter scale) in the photographs of the vehicle's bumper height.

Measure the length of beds of pickup trucks. If the bed is damaged, measure the length where the damage is the least.

The following screens exemplify the procedures to complete the vehicle sketches.

VEHICLE TYPES

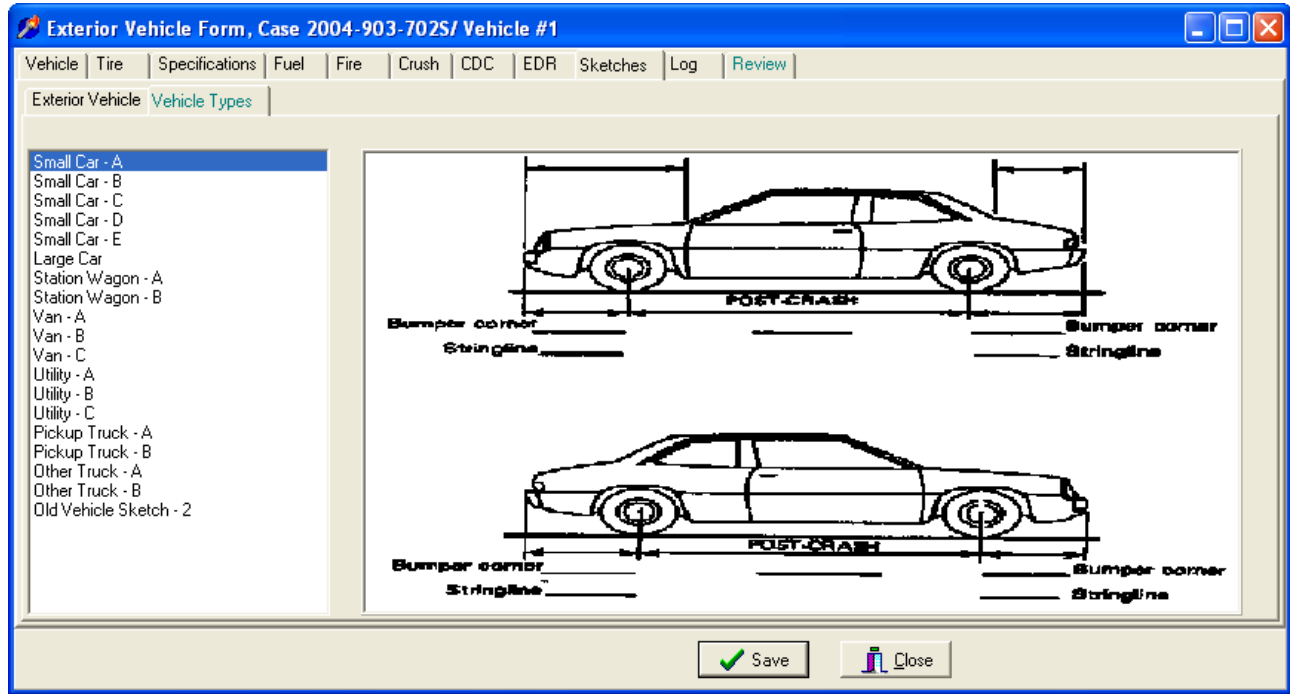

Select vehicle type from left side of screen and double click on type.

**TOP VIEW**

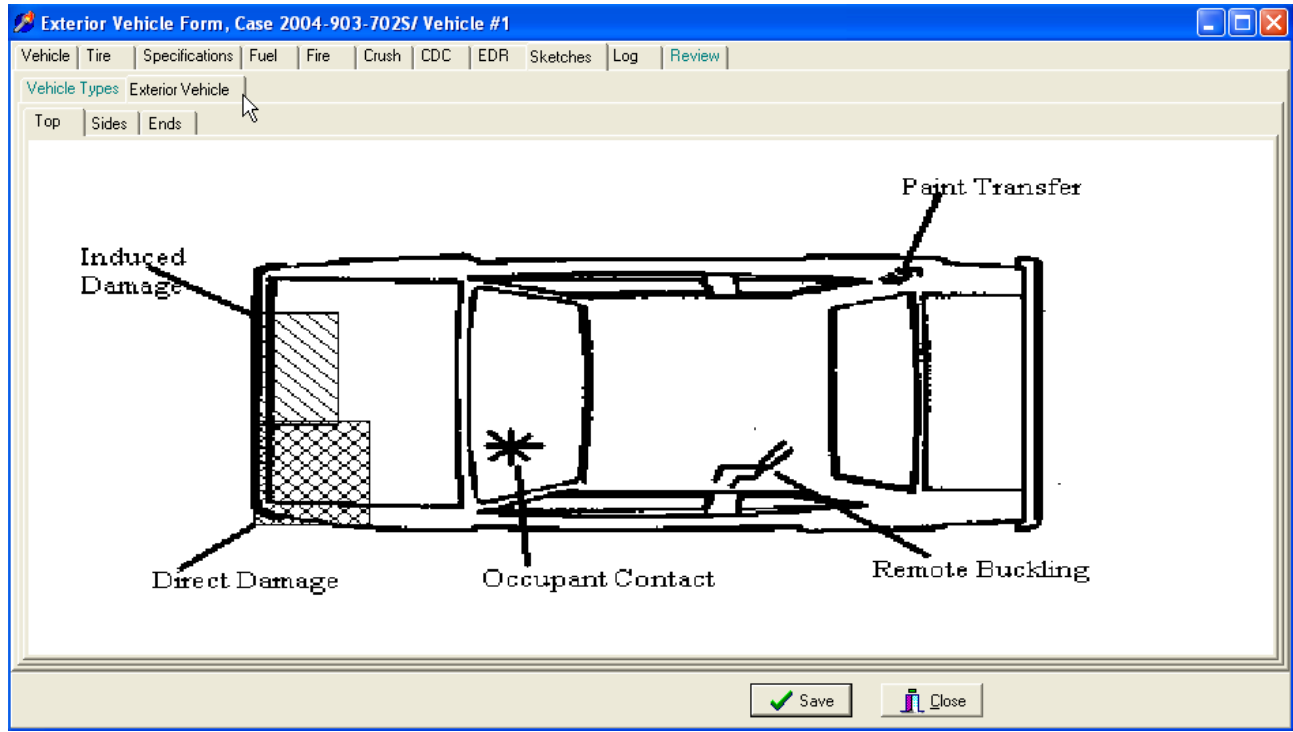

Next, select the End, Side or Top tab for completing the sketches. Then double click on the image to begin sketching the damage and documenting the required measurements.

SIDE VIEW

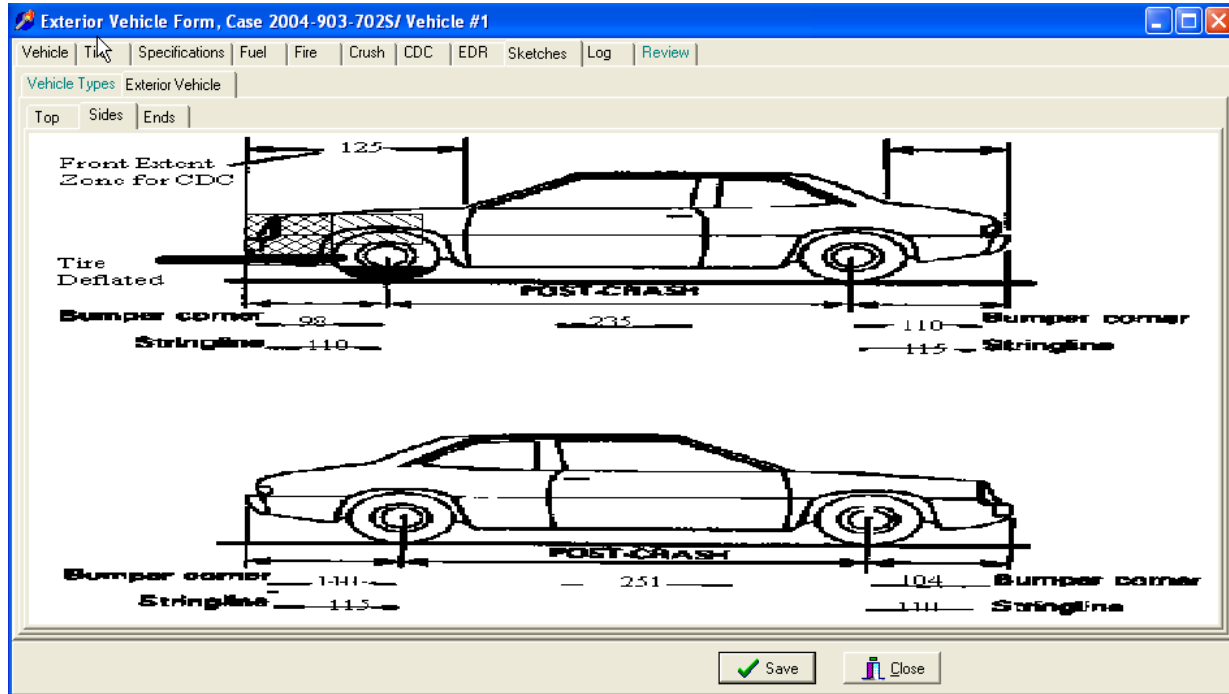

END VIEW

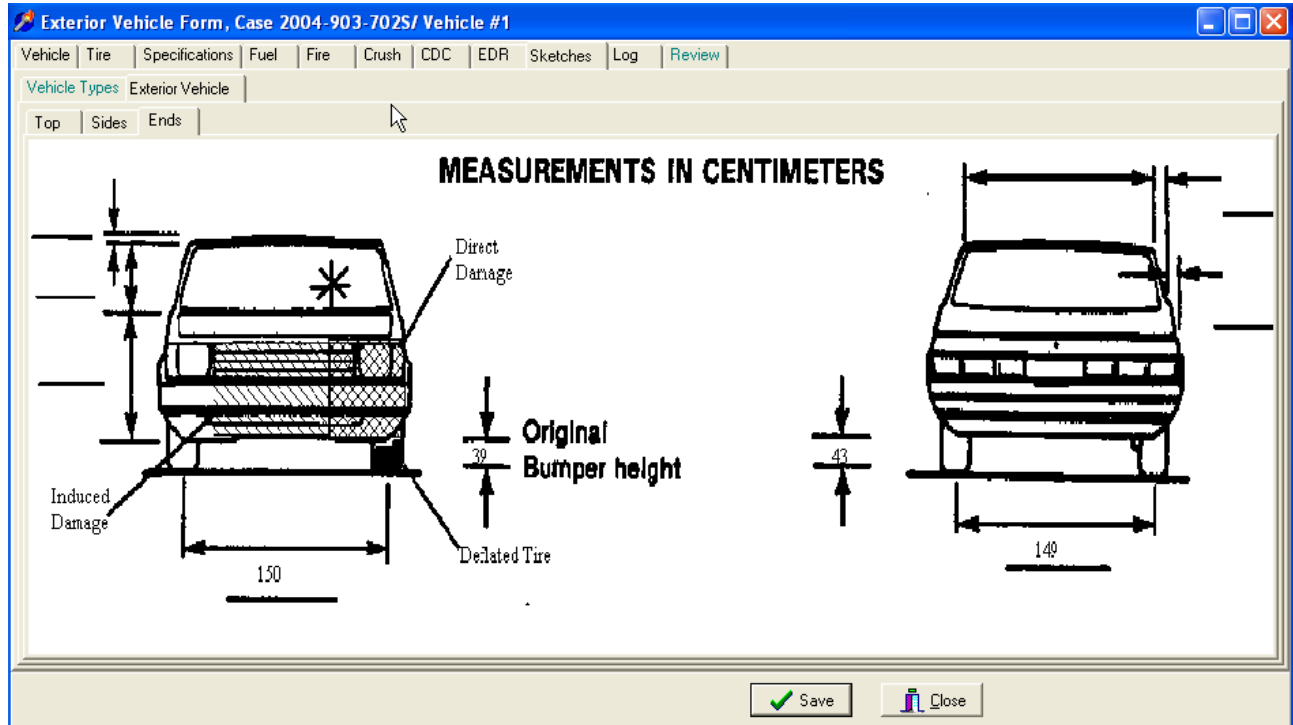

**EXTERIOR VEHICLE FORM**

**SKETCHES/MEASUREMENTS**

Exterior Vehicle Form, Case 2008-43-093B/ Vehicle #1 - Vehicle Measurements

Extent Zone Measurements (cms)			
Front	Back	Side	Vertical
(EF1) Hood <input type="text" value="20"/>	(EB1) Trunk <input type="text" value="Unknown"/>	(ES1) Door <input type="text" value="Unknown"/>	(EV1) Roof <input type="text" value="Unknown"/>
(EF2) Windshield <input type="text" value="Unknown"/>	(EB2) BackLight <input type="text" value="Unknown"/>	(ES2) Glazing <input type="text" value="Unknown"/>	(EV2) Glazing <input type="text" value="Unknown"/>
(EF3) Pillar <input type="text" value="Unknown"/>	(EB3) Pillar <input type="text" value="Unknown"/>	(ES3) Roof <input type="text" value="Unknown"/>	(EV3) Door <input type="text" value="Unknown"/>

Baseline Measurements (cms)		Other Measurements (cms)	
Left	Right	Front	Rear
(BL1) Front OH <input type="text" value="Unknown"/>	(BR1) <input type="text" value="Unknown"/>	(TKWF) Track Width <input type="text" value="Unknown"/>	(TKWR) <input type="text" value="Unknown"/>
(BL2) Front BC <input type="text" value="Unknown"/>	(BR2) <input type="text" value="Unknown"/>	(OBHF) Front Bumper <input type="text" value="Unknown"/>	(OBHR) <input type="text" value="Unknown"/>
(BL3) Wheelbase <input type="text" value="Unknown"/>	(BR3) <input type="text" value="Unknown"/>	<b>Pick-Ups Only (cms)</b>	
(BL4) Rear BC <input type="text" value="Unknown"/>	(BR4) <input type="text" value="Unknown"/>	(POAL) B Pillar <input type="text" value="50"/>	
(BL5) Rear OH <input type="text" value="Unknown"/>	(BR5) <input type="text" value="Unknown"/>	(PBL) B Pillar <input type="text" value="Unknown"/>	

**SIDE DOOR LATERAL WIDTH**

**Screen Name:** Lateral - Door

**SAS Data Set:**

**SAS Variable:**

**Oracle Name:** *VEHICLEMEASUREMENTS.SIDE\_DOOR*

**Element Attributes:**

Oracle	SAS	
		Enter to the nearest centimeter
-8887	887	Not Applicable
-9999	999	Unknown

**Range:** 002-025, 887, 999

**Source:** Vehicle inspection, exemplar vehicle, manufacturer specification

**Remarks:**

Used for determining CDC extent zone one for side impacts.

**Enter to the nearest centimeter**

Measure the undamaged (i.e. original) lateral distance between the bottom of the side glass to the outermost extent of the door.

Do not include any door hardware (e.g. door handles or mirrors).

**Not Applicable**

Used when the vehicle did not sustain a side impact.

**Unknown**

When the measurement cannot be determined or obtained from the original vehicle, exemplar, or any source.

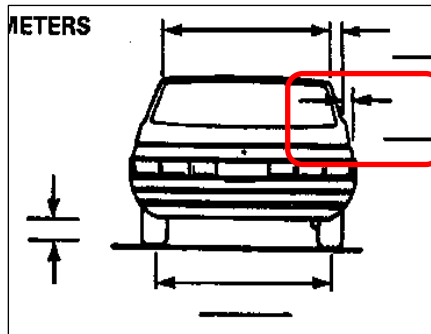



**SIDE GLASS LATERAL WIDTH**

**Screen Name:** Lateral - Glazing

**SAS Data Set:**

**SAS Variable:**

**Oracle Name:** *VEHICLEMEASUREMENTS.SIDE\_GLAZING*

**Element Attributes:**

Oracle	SAS	
		Enter to the nearest centimeter
-8887	887	Not Applicable
-9999	999	Unknown

**Range:** 001-035, 887, 999

**Source:** Vehicle inspection, exemplar vehicle, manufacturer specification

**Remarks:**

Used for determining CDC extent zone two for side impacts.

**Enter to the nearest centimeter**

Measure the undamaged (i.e. original) lateral distance between the bottom of the side glass to the top of the side glass of the same window. Do not consider the window frame when determining the top and bottom of the side glass.

**Not Applicable**

Used when the vehicle did not sustain a side impact.

**Unknown**

When the measurement cannot be determined or obtained from the original vehicle, exemplar, or any source.

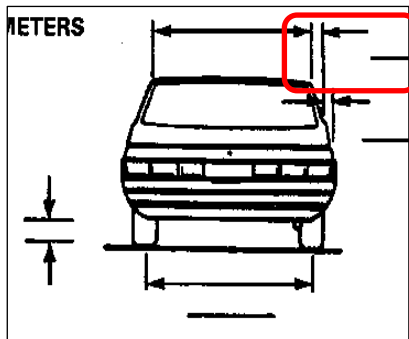

**ROOF LATERAL WIDTH**

**Screen Name:** Lateral - Roof

**SAS Data Set:**

**SAS Variable:**

**Oracle Name:** *VEHICLEMEASUREMENTS.SIDE\_ROOF*

**Element Attributes:**

Oracle	SAS	
		Enter to the nearest centimeter
-8887	887	Not Applicable
-9999	999	Unknown

**Range:** 70-205, 887, 999

**Source:** Vehicle inspection, exemplar vehicle, manufacturer specification

**Remarks:**

Used for determining CDC extent zone three thru eight for side impacts.

**Enter to the nearest centimeter**

Measure the undamaged (i.e. original) lateral distance between the top of the side glass to the top of the side glass on the opposing side of the vehicle. Do not consider the window frame when determining the top of the side glass.

**Not Applicable**

Used when the vehicle did not sustain a side impact.

**Unknown**

When the measurement cannot be determined or obtained from the original vehicle, exemplar, or any source.

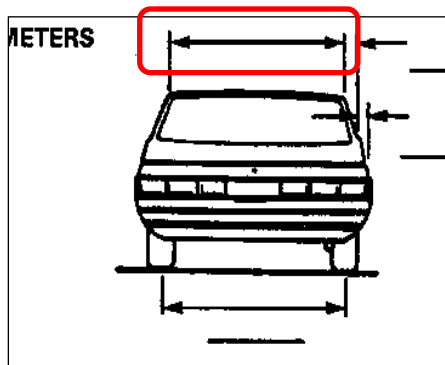

**SIDE DOOR VERTICAL HEIGHT**

**Screen Name:** Vertical - Door

**SAS Data Set:**

**SAS Variable:**

**Oracle Name:** *VEHICLEMEASUREMENTS.VERTICLE\_DOOR*

**Element Attributes:**

Oracle	SAS	
		Enter to the nearest centimeter
-8887	887	Not Applicable
-9999	999	Unknown

**Range:** 040-135, 887, 999

**Source:** Vehicle inspection, exemplar vehicle, manufacturer specifications

**Remarks:**

Used for determining CDC extent zone six thru eight for Top impacts, and two thru four for Undercarriage impacts.

**Enter to the nearest centimeter**

Measure the undamaged (i.e. original) vertical distance between the bottom of the side glass and the bottom of the sill.

**Not Applicable**

Used when the vehicle does not sustain a Top or Undercarriage plane impact.

**Unknown**

When the measurement cannot be determined or obtained from the original vehicle, exemplar, or any source.

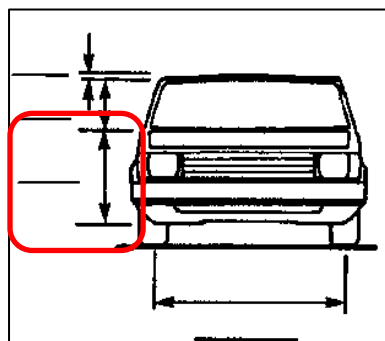

**SIDE GLASS VERTICAL HEIGHT**

**Screen Name:** Vertical - Glazing

**SAS Data Set:**

**SAS Variable:**

**Oracle Name:** *VEHICLEMEASUREMENTS.VEHICLE\_GLAZING*

**Element Attributes:**

Oracle	SAS	
		Enter to the nearest centimeter
-8887	887	Not Applicable
-9999	999	Unknown

**Range:** 015-085, 887, 999

**Source:** Vehicle inspection, exemplar vehicle, manufacturer specifications

**Remarks:**

Used for determining CDC extent zone three thru five for Top impacts, and six thru eight for Undercarriage impacts.

**Enter to the nearest centimeter**

Measure the undamaged (i.e. original) maximum vertical distance between the bottom and top extent of the side glass (not including the window frame).

**Not Applicable**

Used when the vehicle does not sustain a Top or Undercarriage plane impact.

**Unknown**

When the measurement cannot be determined or obtained from the original vehicle, exemplar, or any source.

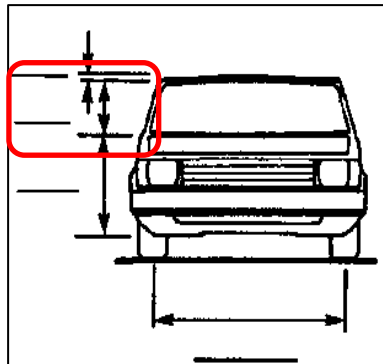

**ROOF VERTICAL HEIGHT**

**Screen Name:** Vertical - Roof

**SAS Data Set:**

**SAS Variable:**

**Oracle Name:** *VEHICLEMEASUREMENTS.VERTICLE\_ROOF*

**Element Attributes:**

Oracle	SAS	
		Enter to the nearest centimeter
-8887	887	Not Applicable
-9999	999	Unknown

**Range:** 001-020, 887, 999

**Source:** Vehicle inspection, exemplar vehicle, manufacturer specifications

**Remarks:**

Used for determining CDC extent zone two for Top impacts.

**Enter to the nearest centimeter**

Measure the undamaged (i.e. original) vertical distance between the uppermost extent of the side glass (not including the window frame) and the top of the roof.

**Not Applicable**

Used when the vehicle does not sustain a Top or Undercarriage plane impact.

**Unknown**

When the measurement cannot be determined or obtained from the original vehicle, exemplar, or any source.

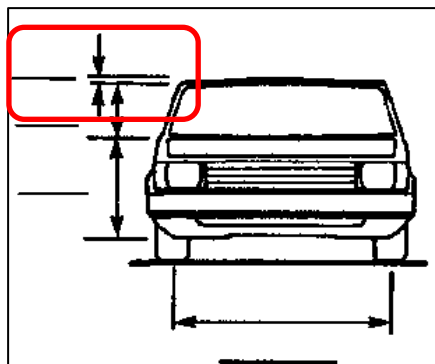

**ORIGINAL FRONT BUMPER HEIGHT**

**Screen Name:** Bumper Height - Front

**SAS Data Set:**

**SAS Variable:**

**Oracle Name:** *VEHICLEMEASUREMENTS.BUMPER\_HEIGHT\_FRONT*

**Element Attributes:**

Oracle	SAS	
		Enter to the nearest centimeter
-8887	887	Not Applicable
-9999	999	Unknown

**Range:** 010-150, 887, 999

**Source:** Vehicle inspection, exemplar vehicle, manufacturer specifications

**Remarks:**

**Enter to the nearest centimeter**

Front precrash bumper height measurements must be obtained for vehicles sustaining any end plane impact with another vehicle (in- transport or not in-transport) [i.e., column (3) of CDC (including non-selected CDCs) must equal "F"].

- Measure from the bottom of the bumper face (reinforcement bar) to the ground.
- Include a calibrated instrument (contour gauge rod or 1 meter scale) in the photographs of the vehicle's bumper height.

**Not Applicable**

Used when the vehicle does not sustain a Front plane impact, or in the rare situation where a vehicle is not equipped with a front bumper or reinforcement bar at the time of the crash.

**Unknown**

When the measurement cannot be determined or obtained from the original vehicle, exemplar, or any source.

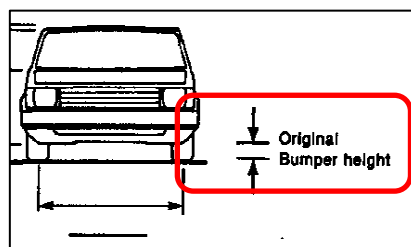

**ORIGINAL REAR BUMPER HEIGHT**

**Screen Name:** Rear Bumper Ht

**SAS Data Set:**

**SAS Variable:**

**Oracle Name:** *VEHICLEMEASUREMENTS.BUMPER\_HEIGHT\_REAR*

**Element Attributes:**

Oracle	SAS	
		Enter to the nearest centimeter
-8887	887	Not Applicable
-9999	999	Unknown

**Range:** 010-150, 887, 999

**Source:** Vehicle inspection, exemplar vehicle, manufacturer specification

**Remarks:**

**Enter to the nearest centimeter**

Rear precrash bumper height measurements must be obtained for vehicles sustaining any end plane impact with another vehicle (in- transport or not in-transport) [i.e., column (3) of CDC (including non-selected CDCs) must equal "B"].

- Measure from the bottom of the bumper face (reinforcement bar) to the ground.
- Include a calibrated instrument (contour gauge rod or 1 meter scale) in the photographs of the vehicle's bumper height.

**Not Applicable**

Used when the vehicle does not sustain a Rear plane impact, or in the rare situation where a vehicle is not equipped with a rear bumper or reinforcement bar at the time of the crash.

**Unknown**

When the measurement cannot be determined or obtained from the original vehicle, exemplar, or any source.

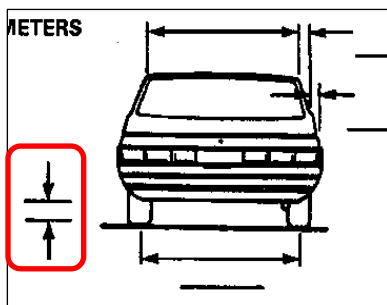

**FRONT TRACK WIDTH (POST CRASH)**

**Screen Name:** Front Track

**SAS Data Set:**

**SAS Variable:**

**Oracle Name:** *VEHICLEMEASUREMENTS.TRACKWIDTH\_FRONT*

**Element Attributes:**

Oracle	SAS	Enter to the nearest centimeter
-8887	887	Not Applicable
-9999	999	Unknown

**Range:** 100-200, 887, 999

**Source:** Vehicle inspection

**Remarks:**

**Enter to the nearest centimeter**

Measure the damaged (i.e., post-crash) distance between the center point of the right front wheel and the center point of the left front wheel. The measurement may also be taken from the inside edge of one wheel to the outside edge of the other.

**Not Applicable**

Used in the rare situation when the vehicle was not manufactured with 2 wheels on the front axle.

**Unknown**

When the measurement cannot be determined or obtained, e.g. wheel(s) missing, completely repaired, etc.

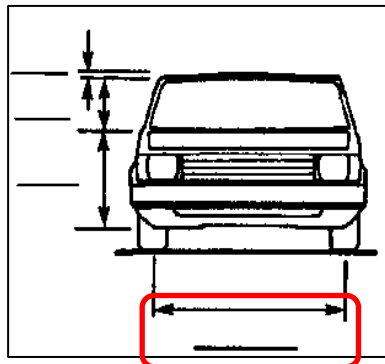



**REAR TRACK WIDTH (POST CRASH)**

**Screen Name:** Rear Track

**SAS Data Set:**

**SAS Variable:**

**Oracle Name:** *VEHICLEMEASUREMENTS.TRACKWIDTH\_REAR*

**Element Attributes:**

Oracle	SAS	
		Enter to the nearest centimeter
-8887	887	Not Applicable
-9999	999	Unknown

**Range:** 100-200, 887, 999

**Source:** Vehicle inspection

**Remarks:**

**Enter to the nearest centimeter**

Measure the damaged (i.e. post-crash) distance between the center point of the right rear wheel and the center point of the left rear wheel. The measurement may also be taken from the inside edge of one wheel to the outside edge of the other.

For vehicles manufactured with dual rear wheels, the measurement should be taken to the center point between the dual wheels to the center point of the opposing dual wheels.

**Not Applicable**

Used when the vehicle was not manufactured with two rear wheels.

**Unknown**

When the measurement cannot be determined or obtained, e.g. wheel missing, completely repaired, etc.

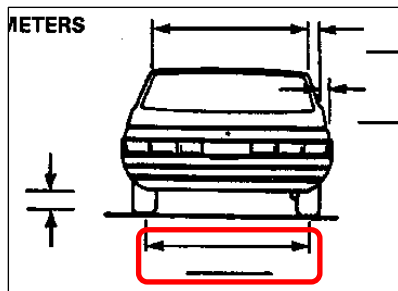

**ORIGINAL HOOD EXTENT**

**Screen Name:** End - Hood

**SAS Data Set:**

**SAS Variable:**

**Oracle Name:** *VEHICLEMEASUREMENTS.FRONT\_HOOD*

**Element Attributes:**

Oracle	SAS	
		Enter to the nearest centimeter
-8887	887	Not Applicable
-9999	999	Unknown

**Range:** 015-225, 887, 999

**Source:** Vehicle inspection, exemplar vehicle, manufacturer specification

**Remarks:**

This measurement is obtained to determine CDC extent zone one thru five for frontal impacts.

**Enter to the nearest centimeter**

Measure the original (i.e. precrash) longitudinal distance along the centerline of the vehicle between the original maximum front extent of the vehicle (e.g. front stringline) and the most forward extent of the base of the windshield (i.e. where the visible portion of the glass ends).

At the windshield, this measurement is normally taken at the center point where the windshield meets the instrument panel.

**Not Applicable**

Used when the vehicle doesn't sustain a frontal impact.

**Unknown**

When the measurement cannot be determined or obtained.

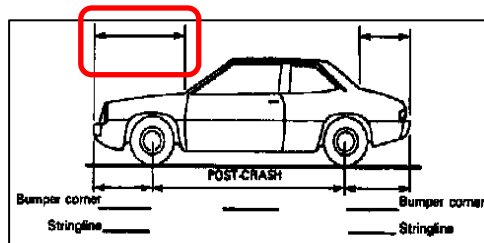

**ORIGINAL WINDSHIELD EXTENT**

**Screen Name:** End - Windshield

**SAS Data Set:**

**SAS Variable:**

**Oracle Name:** *VEHICLEMEASUREMENTS.FRONT\_WINDSHIELD*

**Element Attributes:**

Oracle	SAS	
		Enter to the nearest centimeter
-8887	887	Not Applicable
-9999	999	Unknown

**Range:** 001-150, 887, 999

**Source:** Vehicle inspection, exemplar vehicle, manufacturer specification

**Remarks:**

This measurement is obtained to determine the CDC Extent Zone for frontal impacts to all vehicle types.

**Enter to the nearest centimeter**

Measure the original (i.e. precrash) longitudinal measurement along the centerline of the vehicle between the original forward extent of the vehicle's windshield to the rear extent of the windshield.

**Not Applicable**

Used when the vehicle does not sustain a frontal impact.

**Unknown**

When the measurement cannot be determined or obtained.

**ORIGINAL WINDSHIELD TO B PILLAR**

**Screen Name:** Front – Pillar

**SAS Data Set:**

**SAS Variable:**

**Oracle Name:** *VEHICLEMEASUREMENTS.FRONT\_PILLAR*

**Element Attributes:**

Oracle	SAS	
		Enter to the nearest centimeter
-8887	887	Not Applicable
-9999	999	Unknown

**Range:** 010-150, 887, 999

**Source:** Vehicle inspection, exemplar vehicle, manufacturer specification

**Remarks:**

This measurement is obtained to determine CDC Extent Zone seven and eight for frontal impacts.

**Enter to the nearest centimeter**

Measure the original (i.e. precrash) longitudinal distance between the B Pillar and the top edge of the windshield along the vehicle’s centerline. The measurement should be taken to the longitudinal center of the B Pillar.

**Not Applicable**

Used when the vehicle doesn’t sustain a frontal impact.

**Unknown**

When the measurement cannot be determined or obtained.

**ORIGINAL BACKLIGHT TO B PILLAR LENGTH**

**Screen Name:** BL – B PILLAR

**SAS Data Set:**

**SAS Variable:**

**Oracle Name:** *VEHICLEMEASUREMENTS.BACK\_PILLAR*

**Element Attributes:**

Oracle	SAS	
		Enter to the nearest centimeter
-8887	887	Not Applicable
-9999	999	Unknown

**Range:** 000-300, 887, 999

**Source:** Vehicle inspection, exemplar vehicle, manufacturer specification

**Remarks:**

This measurement is obtained to determine the CDC Extent Zone for rear impacts to automobiles, station wagons, utility vehicles, and vans.

**Enter to the nearest centimeter**

Measure the original (i.e. precrash) longitudinal measurement between the original forward extent of the vehicle's backlight to the center of the top of the B pillar. The measurement should be taken along the centerline of the vehicle.

**Not Applicable**

Used when the vehicle does not sustain a rear impact or if the vehicle is not an automobile, utility vehicle, or van.

**Unknown**

When the measurement cannot be determined or obtained.

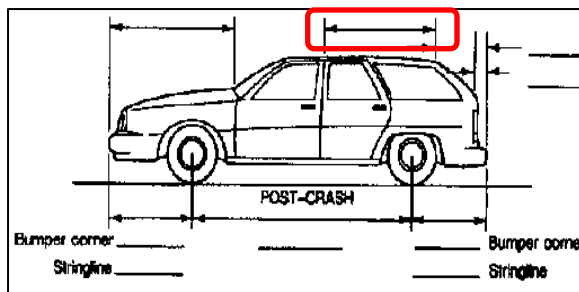

**ORIGINAL BACKLIGHT LENGTH**

**Screen Name:** End - Backlight

**SAS Data Set:**

**SAS Variable:**

**Oracle Name:** *VEHICLEMEASUREMENTS.BACK\_BACKLIGHT*

**Element Attributes:**

Oracle	SAS	
		Enter to the nearest centimeter
-8887	887	Not Applicable
-9999	999	Unknown

**Range:** 001-150, 887, 999

**Source:** Vehicle inspection, exemplar vehicle, manufacturer specification

**Remarks:**

This measurement is obtained to determine the CDC Extent Zone for rear impacts to automobiles, station wagons, utility vehicles, and vans. Please refer to SAE J224MAR80 for further explanation and description.

**Enter to the nearest centimeter**

Measure the original (i.e. precrash) longitudinal measurement between the original forward extent of the vehicle's backlight to the rear extent of the backlight along the vehicle's centerline.

**Not Applicable**

Used when the vehicle does not sustain a rear impact or if the vehicle is not an automobile, utility vehicle, or van.

**Unknown**

When the measurement cannot be determined or obtained.

**ORIGINAL TRUNK LENGTH**

**Screen Name:** End - Trunk

**SAS Data Set:**

**SAS Variable:**

**Oracle Name:** *VEHICLEMEASUREMENTS.BACK\_TRUNK*

**Element Attributes:**

Oracle	SAS	
		Enter to the nearest centimeter
-8887	887	Not Applicable
-9999	999	Unknown

**Range:** 010-145, 887, 999

**Source:** Vehicle inspection, exemplar vehicle, manufacturer specification

**Remarks:**

This measurement is obtained to determine the CDC Extent Zone for rear impacts to automobiles, station wagons, utility vehicles and vans. Please refer to SAE J224MAR80 for further explanation and description.

**Enter to the nearest centimeter**

Measure the original (i.e. precrash) longitudinal measurement between the original maximum rear extent of the vehicle's rear bumper and the most rearward extent of the backlight.

Normally this measurement is taken to the base of the backlight, however there are rare situations when the upper edge of the glazing projects further rearward than the bottom edge. In this circumstance, the measurement is taken to the upper edge of the glazing.

**Not Applicable**

Used when the vehicle does not sustain a rear impact or if the vehicle is a pick-up truck.

**Unknown**

When the measurement cannot be determined or obtained.

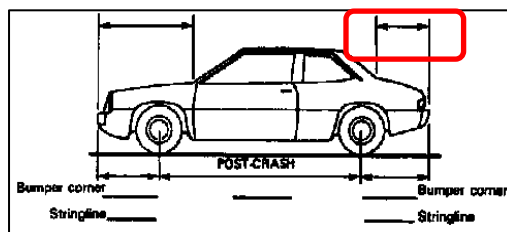

**ORIGINAL PICK-UP REAR EXTENT**

**Screen Name:** P/U Rear

**SAS Data Set:**

**SAS Variable:**

**Oracle Name:** *VEHICLEMEASUREMENTS.OAL\_B.PILLAR*

**Element Attributes:**

Oracle	SAS	
		Enter to the nearest centimeter
-8887	887	Not Applicable
-9999	999	Unknown

**Range:** 90-400, 887, 999

**Source:** Vehicle inspection, exemplar vehicle, manufacturer specification

**Remarks:**

This measurement is obtained to determine CDC extent zones for rear impacts to pick-up trucks.

**Enter to the nearest centimeter**

Measure the original (i.e. precrash) longitudinal measurement between the original maximum rear extent of the vehicle (e.g. rear Stringline) and the center of the B Pillar.

**Not Applicable**

Used when the vehicle does not sustain a rear impact or the vehicle is not a pick-up truck.

**Unknown**

When the measurement cannot be determined or obtained.

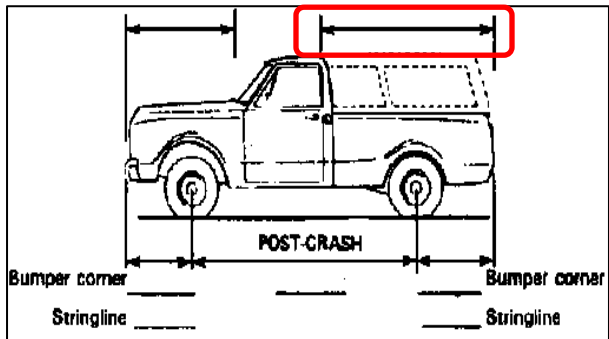



**ORIGINAL PICK-UP BED LENGTH**

**Screen Name:** Bed Length

**SAS Data Set:**

**SAS Variable:**

**Oracle Name:** *VEHICLEMEASUREMENTS.BED\_LENGTH*

**Element Attributes:**

Oracle	SAS	
		Enter to the nearest centimeter
-8887	887	Not Applicable
-9999	999	Unknown

**Range:** 90-250, 887, 999

**Source:** Vehicle inspection

**Remarks:**

This measurement is obtained to verify specifications of pick-up trucks.

**Enter to the nearest centimeter**

Measure the original (i.e. precrash) longitudinal distance of the inside of the pick-up truck's bed.

**Not Applicable**

Used when the vehicle is not a pick-up truck, or if the pick-up truck does not have a bed.

**Unknown**

When the measurement cannot be determined or obtained.

**BASELINE MEASUREMENT – LEFT/RIGHT SIDE FRONT STRINGLINE**

**Screen Name:** Left – FSL/Right - FSL

**SAS Data Set:**

**SAS Variable:**

**Oracle Name:** *VEHICLEMEASUREMENTS.FRONT\_LT\_STRINGLINE/  
FRONT\_RT\_STRINGLINE*

**Element Attributes:**

Oracle	SAS	
		Enter to the nearest centimeter
-8887	887	Not Applicable
-9999	999	Unknown

**Range:** 025-250, 887, 999

**Source:** Vehicle inspection

**Remarks:**

**Enter to the nearest centimeter**

Measure the distance between the post-crash position of the left/right side front axle and the front stringline.

Normally the axle position is measured from the center of the outer hub of the wheel, however if the front wheel exhibits a steer angle or is missing, approximate or use the position of the ball joint or axle.

Include any stingline adjustments.

Obtain this measurement for all vehicles where an end plane stringline is set up regardless of its repair state.

**Not Applicable**

Use this code when the vehicle does not sustain an end plane impact or when an end plane stingline is not set up.

**Unknown**

When the measurement cannot be determined or obtained. This includes completely repaired vehicles.

**BASELINE MEASUREMENT – LEFT/RIGHT SIDE FRONT CORNER**

**Screen Name:** Left – FBC/Right - FBC

**SAS Data Set:**

**SAS Variable:**

**Oracle Name:** *VEHICLEMEASUREMENTS.FRONT\_LT BUMPERCORNER/  
FRONT\_RT BUMPERCORNER*

**Element Attributes:**

Oracle	SAS	
		Enter to the nearest centimeter
-8887	887	Not Applicable
-9999	999	Unknown

**Range:** 000-250, 887, 999

**Source:** Vehicle inspection

**Remarks:**

**Enter to the nearest centimeter**

Measure the distance between the post-crash position of the left/right side front axle and the associated front bumper corner.

Normally the axle position is measured from the center of the outer hub of the wheel, however if the front wheel exhibits an angle or is missing, approximate or use the position of the ball joint or axle.

This measurement is obtained for any end plane or side impacts.

If the bumper structure (including the bumper re-bar) is missing, take the measurement to the next rigid structure.

**Not applicable**

Used when a vehicle is fully repaired, or does not sustain a front or side impact.

**Unknown**

When the measurement cannot be determined or obtained.

**BASELINE MEASUREMENT – LEFT/RIGHT SIDE WHEELBASE**

**Screen Name:** Left – WB/Right - WB

**SAS Data Set:**

**SAS Variable:**

**Oracle Name:** **VEHICLEMEASUREMENTS.WHEELBASE\_LT/  
WHEELBASE\_RT**

**Element Attributes:**

Oracle	SAS	
		Enter to the nearest centimeter
-8887	887	Not Applicable
-9999	999	Unknown

**Range:** 050-650, 887, 999

**Source:** Vehicle inspection

**Remarks:**

**Enter to the nearest centimeter**

Measure the distance between the post-crash position of the left/right side front axle and rear axle.

Normally the axle position is measured from the center of the outer hub of the wheel, however if the front wheel exhibits an angle or is missing, approximate or use the position of the ball joint or axle.

**Not applicable**

Used when a vehicle is fully repaired.

**Unknown**

When the measurement cannot be determined or obtained.

**BASELINE MEASUREMENT – LEFT/RIGHT SIDE REAR CORNER**

**Screen Name:** Left – RBC/Right - RBC

**SAS Data Set:**

**SAS Variable:**

**Oracle Name:** *VEHICLEMEASUREMENTS.REAR\_LT BUMPERCORNER/  
REAR\_RT BUMPERCORNER*

**Element Attributes:**

Oracle	SAS	
		Enter to the nearest centimeter
-8887	887	Not Applicable
-9999	999	Unknown

**Range:** 000-250, 887, 999

**Source:** Vehicle inspection

**Remarks:**

**Enter to the nearest centimeter**

Measure the distance between the post-crash position of the left/right side rear axle and the associated rear bumper corner.

Normally the axle position is measured from the center of the outer hub of the wheel, however if the rear wheel is missing, approximate or use the position of the axle.

This measurement is obtained for any end plane or side impacts.

If the bumper structure (including the bumper re-bar) is missing, take the measurement to the next rigid structure.

**Not applicable**

Used when a vehicle is fully repaired, or does not sustain a front or side impact.

**Unknown**

When the measurement cannot be determined or obtained.

**BASELINE MEASUREMENT – LEFT/RIGHT SIDE REAR STRINGLINE**

**Screen Name:** Left – ROH/Right - ROH

**SAS Data Set:**

**SAS Variable:**

**Oracle Name:** *VEHICLEMEASUREMENTS.REAR\_LT\_STRINGLINE/  
REAR\_RT\_STRINGLINE*

**Element Attributes:**

Oracle	SAS	
		Enter to the nearest centimeter
-8887	887	Not Applicable
-9999	999	Unknown

**Range:** 050-450, 887, 999

**Source:** Vehicle inspection

**Remarks:**

**Enter to the nearest centimeter**

Measure the distance between the post-crash position of the left/right side rear axle and the rear stringline.

Normally the axle position is measured from the center of the outer hub of the wheel, however if the rear wheel is missing, approximate or use the position of the axle.

Include any stingline adjustments.

Obtain this measurement for all vehicles where an end plane stringline is set up regardless of its repair state.

**Not Applicable**

Use this code when the vehicle does not sustain an end plane impact or when a end plane stingline is not set up.

**Unknown**

When the measurement cannot be determined or obtained. This includes completely repaired vehicles.

# EXTERIOR VEHICLE FORM

LOG

Exterior Vehicle Form, Case 2007-996-900015/ Vehicle #2

VEHICLE | TIRE | SPECIFICATIONS | FUEL | FIRE | CRUSH | CDC | EDR | SKETCHES | LOG | REVIEW

Applicable Precrash Measurements

Reference Line Placement

Impact Damage Documentation

Vehicle Damage Sketch

Exterior Slides Subject

Exterior Slides

Primary Error Source

**Remarks:**

- The seven variables listed in the Exterior Vehicle Log tab are completed at the Zone Center level during the Data Quality Control process. Quality ratings for NASS CDS data are divided into the following categories:
- Not Applicable
- Substandard-Beyond Researcher Control
- Substandard
- Standard

These ratings are designed to assess the quality of data collected with respect to NASS program standards. These requirements were derived from field data collection guidelines and researcher training materials. Each variable is rated independently. Overall case quality should not be considered when determining appropriate ratings for each variable.

**Not Applicable**

Defined for each variable.

**Substandard – Beyond Researcher Control**

This rating is used when data requirements set forth under each variable cannot be achieved due to uncontrollable circumstances, which prohibited the researcher from obtaining and properly documenting the data.

**Substandard**

This rating is used when the information set forth under data requirements for each variable is available but is not obtained or is unsatisfactorily documented by the researcher.

When it is unclear which classification to use, Zone Center reviewers default to Substandard (not beyond Researcher control).

**Standard**

This rating is used when data requirements set forth under each variable have been satisfactorily obtained.



**APPLICABLE PRECRASH MEASUREMENTS****Element Values:**

Not Applicable  
Substandard-Beyond Researcher Control  
Substandard  
Standard

**Remarks:**

This variable assesses the acquisition and coding of all precrash measurements including the following:

- Recording all original specifications available for this vehicle
- Recording applicable free space for contacted planes
- Recording all CDC extent zone measurements for each plane contacted, including all measurements required for top plane damage i.e. rollover)
- Recording the undeformed end width and (estimated bumper heights for end plane impacts

Not Applicable is coded if specifications are not available at the PSU or from the Zone Center. All sources are to be considered before using this code.

**REFERENCE LINE PLACEMENT**

**Element Values:**

Not Applicable  
Substandard-Beyond Researcher Control  
Substandard  
Standard

**Remarks:**

This variable assesses the documentation of reference line placement, including damage locator measurements.

Not Applicable is coded when a reference line is not required (i.e. horizontal impacts).

**IMPACT DAMAGE DOCUMENTATION****Element Values:**

Not Applicable (Not a valid code for this variable)  
Substandard-Beyond Researcher Control  
Substandard  
Standard

**Remarks:**

This variable assesses the documentation of the impact damage including all applicable crush profile measurements (L's, C's, D, DDW, Field L, Field L/D). Researchers are required to follow the NASS standards as set forth in the NASS Vehicle Measurements Techniques Document. In assessing this variable the Zone Center reviewer should consult this document to confirm that all measurement protocols were followed.

To meet the Standard assessment, a researcher must document the impact damage for each applicable impact to the vehicle. Each of the impacts is assessed individually in order to evaluate the researcher's adherence to the NASS standard.

Beyond the above requirements, several additional measurements or data elements (included in the NASS standard) are to be obtained. These include:

- The correct Vehicle Identification Number (VIN)
- Post crash wheelbases
- Post crash bumper corner measurements
- Post crash Front/Rear axle to string line measurements for end plane impacts
- Post crash track widths

For impacts where no crush profiles are required the focus of this variable is the researcher's documentation of direct damage, max crush, and any other data required to accurately code a CDC.

Vehicles that are under repair should be documented through the use of damaged parts if they are available. In such instances, the NASS Standard may be attainable, provided the data required in the standard are obtained. It is not possible, however, to attain a Standard rating if the damaged parts have been discarded or if the parts have been altered such that the required measurements cannot be obtained. Similarly, fully repaired vehicles cannot receive a Standard assessment.

**QUALITY OF VEHICLE DAMAGE SKETCH****Element Values:**

Not Applicable (Not a valid code for this variable)  
Substandard-Beyond Researcher Control  
Substandard  
Standard

**Remarks:**

This variable assesses the post impact information reported on the Vehicle Sketch page. To receive a Standard rating, the damage sketch should be a legible representation of all damage drawn on the appropriate vehicle sketch page.

The sketch should include the following:

- Crosshatched lines along the direct damage width, which locate as accurately as possible the width and height of the direct damage.
- Diagonal lines which represent the induced damage as accurately as possible the length and height of the Field L.
- Indications of direct damage that may not be supported by a crush profile (e.g. rollover damage, wheel impacts, contact to glazing).
- Diagonal lines to identify remote buckling or induced damage that is not directly adjacent to the impact.
- Annotation of previous or unrelated damage and/or any damage resulting from towing, extrication or salvage activities.
- Observations, which may be useful in reconstructing the crash sequence (e.g. grass in tire beads, scuffs on sidewalls, direction of striations on tires or body surfaces).
- Annotate “Completely repaired” or “Vehicle under repair” on sketch as applicable.

Substandard-Beyond Researcher Control will be coded for all completely repaired vehicles or vehicles that are under repair.

**EXTERIOR IMAGES SUBJECT QUALITY****Element Values:**

Not Applicable (Not a valid code for this variable)  
Substandard-Beyond Researcher Control  
Substandard  
Standard

**Remarks:**

This variable assesses whether or not all of the proper photographs were obtained during the vehicle inspection. The Standard for NASS Exterior Vehicle Photography is established in the CDS Digital Photography Guideline. The guideline establishes a *minimum* criteria for the NASS researcher. Consequently, all of the photographs dictated by the applicable sections of the document are required to meet the NASS standard. However, in order to properly document unusual or special circumstances additional images may be required. Instructions for photographing frontal and rear impacts, as well as rollovers and completely repaired vehicles are included in the Guideline. For vehicles that have sustained multiple impacts, more than one section will apply. Images must be as complete and concise as possible.

Calibrated measurement rods and a vertical calibrated rod must be present in the images for crush profiles. If measurements are required at two damage levels, images of both sets of profiles must be provided.

Proper rollover documentation includes images of contour rods used to measure the lateral and vertical max crush. (These rods may be attached to the vehicle with tape or clamps.)

An unsanitized image of the VIN plate and uncovered state license plate must be included.

**EXTERIOR IMAGE QUALITY****Element Values:**

Not Applicable (Not a valid code for this variable)  
Substandard-Beyond Researcher Control  
Substandard  
Standard

**Remarks:**

This variable assesses the quality of the images with respect to clarity and crispness. Items evaluated for this variable include:

- Proper framing of the subject
- Light exposure
- Proper focus of the overall subject
- Proper focus of relevant areas with respect to close-up images

**PRIMARY ERROR SOURCE (VEHICLE PLANE)**

**Element Values:**

- No error
- Front
- Side (left or right)
- Top
- Undercarriage
- Other (specify) \_\_\_\_\_

**Remarks:**

This variable is used to identify CDC or crush measurement errors by specific vehicle plane and provides the Zone center with opportunities for technical feedback and/or training. Errors are based on column 3 of the CDC and the associated crush profiles. The primary CDC (highest Delta V) and the associated crush profile receive primary consideration.

Error assessments are based upon the corrected CDC rather than the initial submission. (Example, if a CDC is incorrectly assigned to a side plane and the damage is reassigned to the frontal plane, Front is coded.)

No error is coded when no errors exist in coding the correct plane of impact for the primary CDC (highest Delta V).

LIST

Exterior Vehicle Form, Case 2007-996-900015/ Vehicle #2

VEHICLE | TIRE | SPECIFICATIONS | FUEL | FIRE | CRUSH | CDC | EDR | SKETCHES | LOG | REVIEW

PSU REVIEW | ZONE REVIEW

LIST | DETAIL

Field	Original	Suggested
-------	----------	-----------

Save Close



DETAIL

The screenshot shows a software window titled "Exterior Vehicle Form, Case 2007-996-900015/ Vehicle #2". The window has a menu bar with options: VEHICLE, TIRE, SPECIFICATIONS, FUEL, FIRE, CRUSH, CDC, EDR, SKETCHES, LOG, and REVIEW. Below the menu bar, there are two tabs: "PSU REVIEW" (which is selected) and "ZONE REVIEW". Under the "PSU REVIEW" tab, there are two sub-tabs: "LIST" and "DETAIL" (which is selected). The main area contains several input fields: a "Form" dropdown menu, a "Tab" text field, a "Veh#" text field, and an "Occ #" text field. Below these are "Original" and "Suggested" text fields. A large "Comment" text area is positioned below the "Suggested" field. At the bottom right of the window, there are two buttons: "Save" (with a green checkmark icon) and "Close" (with a red X icon).

INTEGRITY

Interior Vehicle Form, Case 2007-996-900015/ Vehicle #1

INTEGRITY | GLAZING | INTRUSION | INSTRUMENT | STEERING | CONTACT | EJECTION | ENTRAPMENT | LOG | REVIEW

Passenger Compartment Integrity

No Integrity loss     Door (side)     Roof     Side window     Unknown

Windshield     Door/hatch (back door)     Roof glass     Rear window (backlight)

Post crash integrity loss

Location	Opening	Damage/Failure
LF		
RF		
LR		
RR		
TG/H		

Save Close

**[IS THERE PASSENGER COMPARTMENT INTEGRITY LOSS?]****Screen Name:** N/A**SAS Data Set:** VI**SAS Variable:** INTGLOSS**Oracle Name:** DERIVED FROM VEHICLE\_X.COMPARTINTEGRITY**Element Attributes:**

0	No integrity loss
1	Yes integrity loss
9	Unknown integrity loss

**Source:** Vehicle inspection.**Remarks:****No integrity loss**

is selected when the doors, roof, and glazing (as listed below) remained intact during the impact sequence.

**Unknown**

is used in the following situations:

- extrication damage masked integrity loss, and
- integrity loss could not be determined due to circumstances beyond the researcher's control.

**PASSENGER COMPARTMENT INTEGRITY**

**Screen Name:** Passenger Compartment Integrity

**SAS Data Set:** *INTGRTY*

**SAS Variable:** *PASINTEG*

**Oracle Name:** *VEHICLE\_X\_OMPARTINTEGRITY.INTEGRITYID*

**Element Attributes:**

Oracle	SAS	
2	1	Windshield
3	2	Door (side)
4	3	Door/hatch (back door)
5	4	Roof
6	5	Roof glass
7	6	Side window
8	7	Rear window (backlight)
-9999		Unknown
-9998	0	No Integrity Loss

**Source:** Vehicle inspection.

**Remarks:**

Select all that apply.

The question of integrity loss is assessed with respect to impact related damage. The damage can be either direct or induced. Damage which is not impact related (*e.g.*, fire, extrication) is not considered.

Consider the passenger compartment as a "package" which is designed to contain the occupant. If an opening occurs of sufficient magnitude through which an occupant could have been ejected totally or partially (although it is not necessary for an occupant to have been ejected), the integrity of the compartment should be considered to have been lost. While it is difficult to define the magnitude of the opening in a universal manner, the minimum size of the opening would be equivalent to the head of most adults (approximately 15- 20 centimeters). Components which may lose their integrity are restricted to the windshield glazing, window glazing (side, rear, or roof), door or roof.

Doors which open upon impact or glazing that is broken during the impact sequence are considered integrity loss. However, doors which were left open prior to an impact do not constitute damage related loss of integrity and should be reported under **Door, Tailgate Or Hatch Opening**, select **Other**.

**Windshield**

is selected when the glazing is either holed/slit or displaced sufficiently to allow an adult size head to pass through.

**Door (side)**

refers to the door structure and excludes glazing areas. All side doors, whether hinged or sliding are considered here. A door is defined as a structure that allows ingress/egress to the occupant compartment of the vehicle and has hinges and locking mechanism.

**Door/hatch (back door)**

identifies integrity loss of the back door structure and not the glazing. Back doors include hatchback, tailgate, and liftback. In situations where the rear hatch or upper portion of the tailgate is made entirely of glazing material and secured with a latching mechanism, only the latching mechanism should be considered for this attribute. Integrity loss through shattered or displaced rear window glazing is identified in **Rear window**

**Roof**

refers only to the roof structure and not glazing areas. Roof structures containing metal panels (*e.g.*, "T" top roofs) are reported here as well as closed convertible tops.

**Roof glass**

reports glazing material in the roof structure which is broken or displaced.

**Side window**

refers to glazing which was broken or displaced during the crash sequence. Glazing which was totally open prior to the crash and broken (*i.e.*, sidelight rolled down into the door area) is not entered as integrity loss.

**Rear window (backlight)**

includes backlights, hatchbacks / tailgates / liftbacks, and rear door glazing which were broken or displaced.

**Unknown**

is used when an integrity loss could not be determined.

**POST CRASH INTEGRITY LOSS**

**Screen Name:** Post Crash Integrity Loss

**SAS Data Set:** VI

**SAS Variable:** POSTINT

**Oracle Name:** INTERIORVEHICLE.POSTCRASHINTLOSS

**Element Attributes:**

		Check Box
Oracle	SAS	
0	0	No/Unknown
1	1	Yes

**Source:** Vehicle inspection.

**Remarks:**

**Post crash integrity loss**

is selected when the researcher determines that what appears to be integrity loss is caused by post crash actions. Examples:

- The windshield collapses due to extreme outside temperature
- Fire/EMS cut windshield out for extrication
- Fire/EMS cut the pillars or doors for extrication

**Door, Tailgate, or Hatch Opening Overview**

It is the intent of these variables to capture whether a passenger compartment door, tailgate, or hatch opened or remained closed during the crash sequence. The reason the doors came open during the crash is also reported.

The areas of interest include the left front, right front, left rear, right rear, and tailgate/hatch doors (*i.e.*, LF, RF, LR, LR2, LR3, RR, RR2, RR3, TG/H, respectively). The LF and RF doors are the forward most side doors on the left and right sides of a vehicle and the LR and RR doors are the next door (or set of doors) rearward of the LF and RF doors. There are situations where two adjacent doors are used to cover a single opening (*i.e.*, side or rear of a cargo van). These should be treated as a single door. Side doors are applicable whether hinged or on tracks.

A door is defined as a structure that allows ingress/egress to the occupant compartment of the vehicle and has hinges and locking mechanism.

Generally, hatch doors meet the following criteria:

- provide access to the rear cargo area of a passenger car type vehicle, through a large opening backlight,
- are composed primarily of glass and may or may not be framed,
- are hinged at the top and latched at the bottom, and
- are not used in conjunction with a lower door or tailgate.

Some vehicles are equipped with frameless glass hatches which may shatter as a result of an impact. This situation is considered a glazing loss (refer to **Glazing**) rather than a hatch opening unless the hatch did, in fact, open prior to the glass breaking (*i.e.*, release of the latching/hinging mechanism). Some glass hatches may be bordered by a narrow band of metal. The condition of this metal band is the focus of this variable group. These remarks also apply when the upper window of a tailgate assembly is being considered.

Generally, tailgates exist on the rear end plane of a utility/station wagon type vehicles. They may be one or two piece assemblies. In the instance of a two piece unit, they will be hinged at the top and bottom with a horizontal seam. One piece units may be hinged at the top for some vehicles or at the bottom with retracting rear windows for others. Pickup truck tailgates are not included in these variables.

Rear doors may be single or double units covering a single opening. The rear doors are hinged on one or both sides with a vertical seam present in dual door applications. Rear doors are most commonly found on van type vehicles and are indicated under descriptor - "TG/H".

**[DOOR, TAILGATE, OR HATCH LOCATION]**

**Screen Name:** Location

**SAS Data Set:** *DOORS*

**SAS Variable:** *DLOCAT*

**Oracle Name:** *VEHICLEINTEGRITY.INTEGRITYLOCATIONID*

**Element Attributes:**

Oracle	SAS		
1	1	LF	Left Front=1
2	2	RF	Right Front=2
3	3	LR	Left Rear=3
4	4	RR	Right Rear=4
5	5	TG/H	Tail Gate / Hatch=5

**Source:** Vehicle inspection.

**Remarks:**

Information is precoded and a choice is made for filling in subsequent variables



**DOOR, TAILGATE, OR HATCH OPENING**

**Screen Name:** Opening

**SAS Data Set:** *DOORS*

**SAS Variable:** *DOPEN*

**Oracle Name:** *VEHICLEINTEGRITY.PICKOPENING*

**Element Attributes:**

Oracle	SAS	
16	N/A	[No door/gate/hatch]
17	1	Door/gate/hatch remained closed and operational
18	2	Door/gate/hatch came open during collision
19	3	Door/gate/hatch jammed shut
20	8	Others (specify):
21	9	Unknown

**Source:** Vehicle inspection.

**Remarks:**

This variable identifies the operational status of a door, tailgate or hatch during a crash sequence. Priority is given to doors which “open” during the collision. Doors which are pushed inwards and jammed, such that a gap or space occurs, are captured under this variable as **door/gate/hatch jammed shut**. The gap or space that occurs is coded under the variable **Integrity Loss**. Where multiple doors cover a single opening, and the disposition of each door was different, select the response for the door which is first identified in the following priority list:

- Door/gate/hatch came open during collision
- Door/gate/hatch jammed shut,
- Other (specify):
- Door/gate/hatch remained closed and operational
- Unknown

As an example, if one door came open and the other was jammed shut, the proper response would be Door/gate/hatch came open during collision. Gaps caused by body deformation are not selected as door opening events. These gaps will be selected in Passenger Compartment Integrity.

**No door/gate/hatch**

is selected when no OEM door, tailgate, or hatch exists in the appropriate area (*i.e.*, LF, RF, LR, RR, TG/H).

**Door/gate/hatch remained closed and operational**

for any door, tailgate, or hatch which did not open during the crash sequence and remained operational.

**Door/gate/hatch came open during collision**

is selected when the door assembly opened during the crash sequence, irrespective of the cause. Further, the magnitude of the opening created is inconsequential when selecting this response. Note, if this response is selected then the **Damage/Separation** responses for the next variable, must be indicated, based on what caused the door / hatch to come open. The researcher must consider the potential that a sprung-mass situation may exist. In this condition, the door may have been opened after the crash, but due to vehicle body stresses the door cannot be shut. This is an important consideration when assessing whether the door came open during the collision.

**Door/gate/hatch jammed shut**

is selected when a door is rendered inoperable due to being jammed shut. Inoperable is defined as the inability of the researcher to open the door wide enough (through the use of reasonable force) to allow passage of an adult head. It is irrelevant whether the jamming is a result of latch or hinge failure, the displacement of adjacent body panels, or direct damage. Undamaged locked doors should not be considered as jammed or inoperable. Doors which were pried open following the crash are an indication of jamming and should be closely examined. In this situation, the researcher should thoroughly annotate and photograph the door area to support this conclusion.

**Others (specify)**

is selected for those situations which cannot be identified with other elements. Doors which are open prior to the crash are reported here (*e.g.*, hatchbacks open for cargo reasons, ventilation, etc.).

**Unknown**

is used when the researcher could not make a performance assessment of the door, tailgate or hatch.

**DAMAGE/SEPARATION ASSOCIATED WITH DOOR, TAILGATE, OR HATCH OPENING IN COLLISION**

**Screen Name:** Damage/Separation

**SAS Data Set:** *DOORS*

**SAS Variable:** *DFAILURE*

**Oracle Name:** *VEHICLEINTEGRITY.PICKOPENINGFAILURE*

**Element Attributes:**

Oracle	SAS	
		[No door/gate/hatch]
22	1	[Door not opened/separation not assessed]
23	2	Door operational
24	3	Latch/striker separation due to damage
25	4	Hinge separation due to damage
26	5	Door structure separation due to damage
27	6	Door support ( <i>i.e.</i> , pillar, sill, roof side rail, etc.) separation due to damage
28	7	Latch/striker and hinge separation due to damage
29	8	Other separation (specify):
30	9	Unknown
		[Door not opened]

**Source:** Vehicle inspection.

**Remarks:**

This variable is designed to capture the reason a door opened during the collision sequence.

**[No door/gate/hatch]**

is automatically selected when:

- no door, tailgate, or hatch exists.
- the door/tailgate/hatch did not open during the crash sequence or
- the door/tailgate/hatch is jammed shut.

Doors which were open prior to the crash (hatchbacks open for cargo reasons, ventilation, etc.) also are reported here.

**[Door not opened]**

is automatically selected when:

- the door/tailgate/hatch did not open during the crash sequence or
- the door/tailgate/hatch is jammed shut.

**Door operational**

is selected when the door, tailgate, or hatch opened during the crash sequence, but the unit was undamaged and remained operational.

**Latch/striker separation due to damage**

is selected when the door, tailgate, or hatch opened as a result of a separation of the latch/striker assembly. The separation must be due to damage, either direct or induced, and must result in the forced unlatching of the latch/striker assembly or shearing of the striker post.

**Hinge separation due to damage**

is selected to indicate that a hinge separation exists as a result of either direct or induced damage. A hinge separation includes the complete separation of the hinge assembly from the door structure, pillar or of the two or more components which comprise the hinge assembly.

**Door structure separation due to damage**

is selected anytime the door structure sustained damage which allowed the latch, striker, or hinge to separate from the mounting surface (*i.e.*, torn metal). The door structure is defined as all components of the door assembly exclusive of the door skin.

**Door support (*i.e.*, pillar, sill, roof side rail, etc.)**

is selected to define situations where the latch/striker assembly did not separate, but the door support areas are damaged sufficiently to allow for the door to open. This includes, but is not limited to, the damage of pillars, sills and/or roof side rails at its most severe level.

**Latch/striker and hinge separation due to damage**

Latch/striker and hinge separation due to damage is used to describe situations where the entire door and adjacent components (*i.e.*, pillars) are torn away by an impact. Separation must be present to the latch/striker and at least one hinge, resulting in the door opening (*i.e.*, door partially or completely torn off).

**Other separation (specify)**

is used to indicate that an opening exists which cannot be described with the attributes above. This includes vehicles with a canvas roof and door structure (*i.e.*, Jeeps, etc.).

**Unknown**

is used when it cannot be determined which attribute applies.

GLAZING

Interior Vehicle Form, Case 2008-43-093B/ Vehicle #2

INTEGRITY | **GLAZING** | INTRUSION | INSTRUMENT | STEERING | CONTACT | EJECTION | ENTRAPMENT | REVIEW | LOG

Location	Glazing Type	Precrash Status	Impact Damage	Occupant Damage
WS	AS-1 - Laminated	Fixed	No glazing damage from impact	No occupant contact
LF				
RF				
LR				
LR2				
RR				
RR2				
LR/3				
<b>I</b> RR/3	No glazing <input type="button" value="v"/>	No glazing	No glazing	No glazing
BL				
LBL				
RBL				
Roof				
Other				

**Glazing Type and Damage Overview**

Glazing is defined for these variables as a covering for openings in the vehicle's structure which has the ability to allow light to pass. The areas of interest include: the windshield, sidelight windows, backlight (hatchback, tailgate, liftback, rear window), and roof. Composition of glazing materials in use include: glass, plastic, and glass-plastic.

The potential for occupant ejection is a major concern of rulemakers at NHTSA. These variables are designed to record the successes and failures of occupant containment by glazing when there is an occurrence of occupant contact to the glazing, or glazing damage by impact forces or vehicle damage.

There is glass that involves a plastic anti-lacerative layer applied to the inner surface of windshields (such as Inner Shield, Securiflex, etc.). Glass - plastic should not be confused with the current design of laminate windshields which are made with a layer of plastic (Polyvinyl Butyral) between two layers of annealed glass.

Researchers are required to thoroughly inspect all glazing for direct occupant contact/damage and encode their findings. This information is recorded independent of occupant ejection.

Glazing variables are divided into four sections.

**Type**  
**Pre-crash Glazing Status**  
**Impact Damage**  
**Occupant Damage**

These sections are further divided into fourteen specific areas of interest or Locations:

WS	=	Windshield
LF	=	Left front window (driver's window)
RF	=	Right front window
LR	=	Left rear window (adjacent to LF window)
LR2	=	2 <sup>nd</sup> left rear window (adjacent to LR window)
LR3	=	3 <sup>rd</sup> left rear window (adjacent to LR2 window)
RR	=	Right rear window (adjacent to RF window)
RR2	=	2 <sup>nd</sup> right rear window (adjacent to RR window)
RR3	=	3 <sup>rd</sup> right rear window (adjacent to RR2 window)
BL	=	Backlight, tailgate / hatchback / liftgate window
LBL	=	Left backlight (left side of a divided backlight, i.e., rear doors on some vans)
RBL	=	Right backlight (right side of a divided backlight, i.e., rear doors on some vans)
Roof	=	Sun roof, moon roof, "T" roof, etc.
Other	=	Other sidelights, door wing windows, and any other light not identified above

---

**Glazing Type and Damage Overview (cont'd)**

Page 2 of 2

The "other" category (as noted) encompasses areas where glazing may be directly contacted by occupants or damaged from impact forces and not identified by a specific location. This would include wing windows located in door areas. In the event more than one "other" area was involved, select the area with the highest priority number as ranked above. When more than one glazing has priority, the researcher should select the glazing which is closest to the front of the vehicle with the left side taking precedence over the right side. The researcher must specify the selected glazing in the space provided.

**LOCATION OF WINDOW/WINDSHIELD GLAZING**

**Screen Name:** Location

**SAS Data Set:** *GLAZING*

**SAS Variable:** *GLOC*

**Oracle Name:** *VEHICLEGLAZING.GLAZINGLOCATIONID*

**Element Attributes:**

Oracle	SAS	
1	1	Windshield (WS)
2	2	Left front window (driver's window) (LF)
3	3	Right front window (RF)
4	4	Left rear window (adjacent to LF window) (LR)
5	5	2 <sup>nd</sup> left rear window (adjacent to LR window) (LR2) 3 <sup>rd</sup> left rear window (adjacent to LR2 window) (LR3)
6	6	Right rear window (adjacent to RF window) (RR)
7	7	2 <sup>nd</sup> right rear window (adjacent to RR window) (RR2) 3 <sup>rd</sup> right rear window (adjacent to RR2 window) (RR3)
10	8	Backlight, tailgate/hatchback/liftgate window (BL)
11	9	Left backlight (left side of a divided backlight, i.e., rear doors on some vans) (LBL)
12	10	Right backlight (right side of a divided backlight, i.e., rear doors on some vans) (RBL)
15	11	Sun roof, moon roof, "T" roof, etc. (Roof)
20	98	Other sidelights, door wing windows, and any other light not identified above (Other)

**Source:** Vehicle inspection.

**Remarks:**

Information is pre-coded and a choice is made for filling in subsequent variables.



**TYPE OF WINDOW/WINDSHIELD GLAZING**

**Screen Name:** Type  
**SAS Data Set:** *GLAZING*  
**SAS Variable:** *GLTYPE*  
**Oracle Name:** *VEHICLEGLAZING.PICKGLAZINGTYPE*

**Element Attributes:**

Oracle	SAS	
1	0	NA No glazing
2	1	AS-1 - Laminated
3	2	AS-2 - Tempered
37	11	AS-2 - Laminated
38	12	AS-2 - Laminated-with after market tint
5	4	AS-2 - Tempered-with after market tint
4	3	AS-3 - Tempered-tinted (original)
39	13	AS-3 - Laminated tinted (original)
40	14	AS-3 - Laminated tinted (with additional after market tint)
6	5	AS-3 - Tempered-tinted (with additional after market tint)
41	15	AS-6 - Flexible plastic safety glazing
8	7	Glazing removed prior to crash
42	98	Other (specify):
43	99	Unknown

**Source:** Vehicle inspection.

**Remarks:**

Glazing types are identified by unique AS (American Standard) numbers which are etched in the glazing surface. The AS numbers are generally grouped with other glazing information and together make up an informational symbol referred to as a "watermark" (see diagram below). The arrow indicates the "AS number" within the watermark.



Glazing types are used whether or not the glazing area was identified as damaged from impact forces or direct occupant contact. When all side and rear windows have been broken out, examine the window track or frame for remnants of broken glass. If glass is present and the remnants are small clear granules (or cracked in granule size pieces), then it is permissible to select (AS-2 Tempered). If these remnants are tinted, then it is permissible to select [AS-3 - Tempered - tinted (original)]. If these remnants have any plastic tint shield clinging to them, then it is permissible to select (AS-2 Tempered – with after market tint) or [AS-3 Tempered - tinted (with additional after market tint)]. If the glazing of the side glass appears to be held together by plastic coating, then it is permissible to select AS2/3 Laminated, respectively.

**No glazing**

is selected for specific areas where the body structure was not designed to accept glazing (*i.e.*, solid roof structure, etc.).

**AS-1 - Laminated**

refers to a layer of plastic between two layers of glass. This type of glazing is widely used in current windshield installations.

**AS-2 - Tempered**

refers to glass which is designed to break into small glass granules when damaged.

**AS-2 - Laminated**

refers to glass which is composed of two pieces of glass laminated together by a plastic interlayer. This type of glass when damaged does not break into small granules.

**AS-2 - Laminated-with after market tint**

refers to AS-2-Laminated glazing which has an aftermarket plastic tint applied.

**AS-2 - Tempered - with after market tint**

refers to AS-2 glazing which has an aftermarket plastic tint shield applied.

**AS-3 - Tempered - tinted (original)**

refers to manufactured tinted (privacy) glass which has the ability to break into small glass granules when damaged. Glazing which has an aftermarket plastic tint shield applied should be listed as **AS-2 - Tempered - with after market tint**.

**AS-3 - Laminated - tinted (original)**

refers to manufactured tinted glass which is composed of two pieces of glass laminated together by a plastic interlayer. This type of glass when damaged does not break into small granules.

**AS-3 - Laminated tinted (with additional after market tint)**

refers to AS-3 Laminated glazing which has an additional aftermarket plastic tint shield applied.

Type of Window/Windshield Glazing (cont'd)

Page 3 of 3

**AS-3 - Tempered – tinted (with additional after market tint)**

refers to AS-3 glazing which has an additional aftermarket plastic tint shield applied.

**AS-6 - Flexible plastic safety glazing**

refers to plastic side and rear windows. This type of glazing is usually found in convertibles and Jeeps.

**Glazing removed prior to crash**

includes sun roofs, "T" tops, etc. which were removed from their respective areas prior to the crash.

**Other (specify)**

refers to any glazing which has an AS number different from AS-1, AS-2, AS-3 and AS-6. Write the AS number of the glazing in the "specify" space provided. This includes plastic (AS-11C), bullet proof (AS-10), and anti-lacerative (AS-14).

**Unknown**

is used in the following situations:

- Due to factors beyond the researcher's control, an adequate determination of glazing presence could not be made.
- A reasonable determination of the "AS" number could not be made.

**WINDOW PRECRASH STATUS**

**Screen Name:** Pre Crash Status

**SAS Data Set:** *GLAZING*

**SAS Variable:** *GLPRCRSH*

**Oracle Name:** *VEHICLEGLAZING.PICKPRECRASHSTATUS*

**Element Attributes:**

Oracle	SAS	
11	0	N/A [No glazing]
12	1	Fixed
13	2	Closed
14	3	Partially opened
15	4	Fully opened
16	7	Glazing removed prior to crash
17	9	Unknown

**Source:** Vehicle inspection with verification from interview, if possible.

**Remarks:**

This variable records the operational modes of the glazing prior to the crash.

**No glazing**

is used for specific areas where the body structure was not designed to accept glazing (*i.e.*, solid roof structure, etc.).

**Fixed**

identifies glazing which is not designed to open (*e.g.* windshields, etc.).

**Closed**

refers to any operable glazing which was fully closed (*i.e.*, no air gaps).

**Partially opened**

refers to any operable glazing which is not firmly closed (*i.e.*, air gaps present) and not fully opened. Note, the researcher should select the placement of the window in relationship to the opening and not by window design limitations (*i.e.*, rear sedan windows designed not to fully open).

**Fully opened**

refers to any operable glazing which is attached to the vehicle (*i.e.*, window tracks) and was placed in the open position such that the glazing was not restricting the opening of the vehicle structure. This element is assessed independently of window design limitations (*i.e.*, side windows designed to only roll down halfway cannot receive this attribute).

**Glazing removed prior to crash**

includes sun roofs, "T" tops, etc. which were removed from their respective areas prior to the crash.

**Unknown**

is used in the following situation:

- Due to factors beyond the researcher's control, an adequate determination of glazing presence could not be made.

**Screen Name:** Impact Damage

**SAS Data Set:** *GLAZING*

**SAS Variable:** *GLIMPACT*

**Oracle Name:** *VEHICLEGLAZING.PICKIMPACTDAMAGE*

**Element Attributes:**

Oracle	SAS	
18	0	N/A [No glazing]
19	1	No glazing damage from impact forces
20	2	Glazing in place and cracked from impact forces
21	3	Glazing in place and holed from impact forces
22	4	Glazing out-of-place (cracked or not) and not holed from impact forces
23	5	Glazing out-of-place and holed from impact forces
24	6	Glazing disintegrated from impact forces
25	7	Glazing removed prior to crash
26	9	Unknown if damaged

**Source:** Vehicle inspection

**Remarks:**

This variable identifies damage to the glazing as a result of impact forces and/or vehicle damage (including damage from interior loose objects). Damage caused by direct occupant contact should be recorded in the variable **Occupant Damage**.

**NOTE:** Glazing(s) which are retracted into vehicle body panels (*i.e.*, fully open) are to be assessed. Caution should be used in assessing glazing(s) that have post crash damage from sun/heat build up and or extrication.

**No glazing**

is used for specific areas where the body structure was not designed to accept glazing (*i.e.*, solid roof structure, etc.).

**No glazing damage from impact forces**

is selected when there was no damage to the glazing from impact forces. Glazing damage for these variables is defined as cracking, holed, out-of-place or disintegrated. Glazing which is scratched is considered not damaged.

**Glazing in place and cracked from impact forces**

is selected when the glazing remained within the confines of its specific area and was cracked. Displaced glazing which was not totally separated from the vehicle should be treated as "in place". This would include windshields with partial bond separation and dislodged side glazing(s).

**Glazing in place and holed from impact forces**

is selected when the glazing was "holed". "Holed" refers to a hole or slit in the glazing which is large enough in size to allow passage of an adult head (approximately 15-20 centimeters). For the purpose of this variable, the hole or slit must have been produced by impact force and/or vehicle damage and not by direct occupant contact.

**Glazing out-of-place (cracked or not) and not holed from impact forces**

refers to glazing which was totally separated from the vehicle as the result of impact forces and/or vehicle damage. Windshields with 100 percent bond separation should receive this attribute. Caution must be exercised by the researcher not to consider shattered tempered glass (*i.e.*, sidelights, etc.) as out-of-place. This situation should be identified as **Glazing disintegrated from impact forces**.

**Glazing out-of-place and holed from impact forces**

refers to glazing that was totally separated from the vehicle during the crash sequence and was holed/slit as the result of impact forces or vehicle damage. "Holed" refers to either a hole or slit in the glazing which is large enough in size to allow passage of an adult head (approximately 15-20 centimeters).

**Glazing disintegrated from impact forces**

refers to glazing that was totally destroyed by impact forces or vehicle damage. This usually occurs with shattered tempered glass (*i.e.*, sidelights, etc.). Windshields that are separated from the vehicle should not be considered disintegrated. Uncertainty may exist when determining the cause of shattered sidelight glazing when the collision occurred adjacent to an occupied seat. As a rule of thumb, impact forces and/or vehicle damage generally cause disintegration of the sidelight prior to occupant contact.

**Glazing removed prior to crash**

includes sun roofs, "T" tops, etc. which were removed from their respective areas prior to the crash.

**Unknown if damaged**

is selected in the following situations:

- The degree of damage could not be determined as the result of post impact damage (*i.e.*, extrication, towing operations, etc.).

- Due to factors beyond the researcher's control, an adequate determination of glazing damage could not be made (*i.e.*, catastrophic type vehicle damage, etc.). This should be a rare occurrence.
- The cause of glazing damage (*i.e.*, impact forces versus occupant contact) could not be determined by the researcher. Caution, it is anticipated this reason will be rarely used. When confronted with this dilemma, every effort must be made to select a known value for damaged glazing.



**GLAZING DAMAGE FROM OCCUPANT CONTACT**

**Screen Name:** Occupant Damage

**SAS Data Set:** *GLAZING*

**SAS Variable:** *GLOCCUPT*

**Oracle Name:** *VEHICLEGLAZING.PICKOCCUPANTDAMAGE*

**Element Attributes:**

Oracle	SAS	
27	0	NA [No glazing]
28	1	No occupant contact
29	2	Glazing contacted by occupant but no glazing damage
30	3	Glazing in place and cracked by occupant contact
31	4	Glazing in place and holed by occupant contact
32	5	Glazing out-of-place (cracked or not) by occupant contact and not holed by occupant contact
33	6	Glazing out-of-place by occupant contact and holed by occupant contact
34	7	[Glazing removed prior to crash]
35	8	Glazing disintegrated by occupant contact
36	9	Unknown if contacted by occupant

**Source:** Vehicle inspection.

**Remarks:**

These variables report direct occupant contact to the glazing during the crash sequence. The responses are prioritized, the further you go down the list, the higher the priority, [*i.e.*, **Glazing in place and holed by occupant contact** takes precedence over **Glazing in place and cracked by occupant contact**, etc.].

**NOTE:** Glazing(s) which are retracted into vehicle body panels (*i.e.*, fully open) are to be assessed.

**No occupant contact**

is selected when there are no direct occupant contact(s) detected on the glazing.

**Glazing contacted by occupant but no glazing damage**

is selected when an occupant directly contacted the glazing, but the contact did not result in glazing damage.

**Glazing in place and cracked by occupant contact**

refers to glazing that was damaged (not holed) by direct occupant contact. The term "in place" describes glazing which has remained within the confines of its specific area. Displaced glazing

which was not totally separated from the vehicle should be treated as "in place". This would include windshields with partial bond separation and dislodged side glazing.

**Glazing in place and holed by occupant contact**

is selected when the glazing was "holed". "Holed" refers to a hole or slit in the glazing which was produced by direct occupant contact. This opening is equivalent in size to the space necessary to allow passage of an adult head (approximately 15 -20 centimeters).

**Glazing out-of-place (cracked or not) by occupant contact and not holed by occupant contact**

refers to glazing which was directly contacted by an occupant and was totally separated from the vehicle during the crash sequence. Windshields with 100 percent bond separation are reported here. Caution must be exercised by the researcher not to consider shattered tempered glass (*i.e.*, sidelights, etc.) as out-of-place. This situation is reported as **Glazing disintegrated by occupant contact**

**Glazing out-of-place by occupant contact and holed by occupant contact**

refers to glazing which was contacted and holed by direct occupant contact and totally separated from the vehicle during the crash sequence. "Holed" refers to a hole or slit in the glazing which was produced by direct occupant contact. This opening is equivalent in size to the space necessary to allow passage of an adult head (approximately 15 -20 centimeters).

**Glazing removed prior to crash**

includes sun roofs, "T" tops, etc. which were removed from their respective areas prior to the crash. Glazing retracted into vehicle body panels (*i.e.*, fully open) is not considered in this element.

**Glazing disintegrated by occupant contact**

refers to glazing that was totally destroyed by direct occupant contact. This usually occurs with shattered tempered glass (*i.e.*, sidelights, etc.). Windshields that were separated from the vehicle should not be considered disintegrated. Uncertainty may exist when determining the cause of shattered sidelight glazing when the collision occurred adjacent to an occupied seat. As a rule of thumb, impact forces and/or vehicle damage generally cause disintegration of the sidelight prior to occupant contact. If the glazing is indicated in **Impact Damage** as "Disintegrated by Impact Forces" this variable must be coded as **No Occupant Contact**.

**Unknown if contacted by occupant**

is selected in the following situations:

- Direct occupant contact/damage could not be determined due to post impact damage (*i.e.*, extrication, towing operations, etc.).
- Due to factors beyond the researcher's control, an adequate determination of direct occupant contact/damage could not be made.

**OCCUPANT AREA INTRUSION OVERVIEW**

Page 1 of 4

If there is no intrusion select the "No Intrusion" button on the Sketch subtab.

Displacement of less than three centimeters is not considered to be an intrusion.

Intrusion results whenever the internal boundary surface of the passenger compartment is moved inward due to direct or indirect damage resulting from the application of a crushing force to the exterior surface of a vehicle. An exterior component can intrude into the passenger compartment. A passenger compartment is defined as that interior occupant space which is normally available for occupant seating, based upon both the vehicle design and seat configuration at the time of the crash. Adjacent cargo areas and other enclosed areas are included for consideration in the following situations.

The area behind the last row of seats designed by the manufacturer for cargo is integral with the passenger compartment.

An area where a seat row was either removed or folded down to accommodate cargo.

Intrusion can occur from the vertical, longitudinal, or lateral direction. Intrusion can also occur from the displacement of interior seatbacks and/or seat cushions.

**Measurement of Passenger Compartment Intrusion*****Types of Intrusion***

Two types of intrusions occur most often in crashes. They are:

**Type A:** Intrusion which is limited to one part of the passenger compartment and where the other side of the vehicle remains relatively free of distortion. This is likely to be the case in the majority of crashes. In many cases it will be possible to obtain undeformed vehicle dimensions as the vehicle is symmetrical about the longitudinal centerline.

**Type B:** Intrusion which occurs in many sections of the passenger compartment with little of the vehicle remaining free of distortion. In this case, it will be necessary to obtain "original" dimensions by comparison with a second (unintruded) vehicle of the same type.

**FIGURE 1**

**Establishment of Reference Axis.** In order to compare one side of a vehicle with the other or compare two vehicles, a coordinate system within the vehicle is required. An example of Type A and Type B intrusions are shown in Figure 1.

**TYPE A INTRUSION:** \_\_\_\_\_

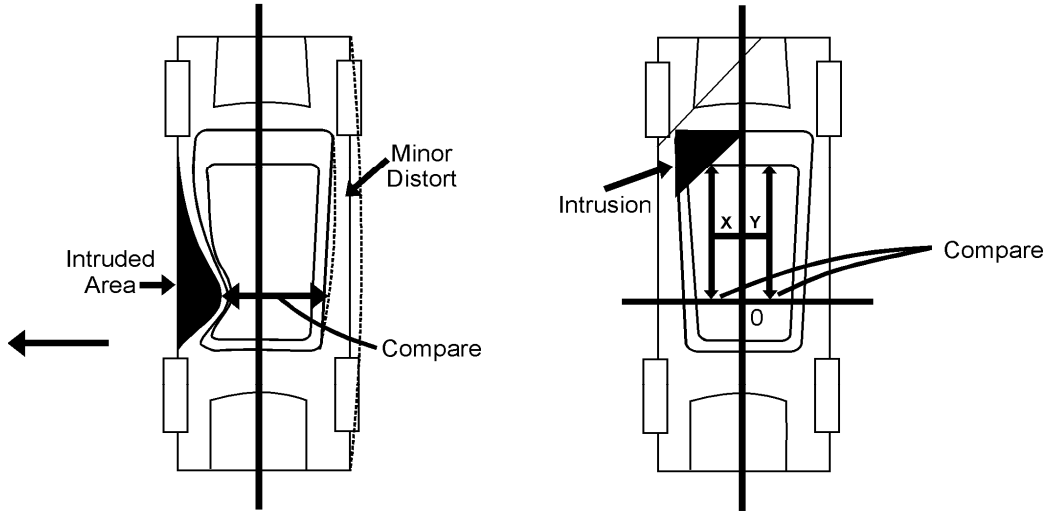

**TYPE B INTRUSION:** \_\_\_\_\_

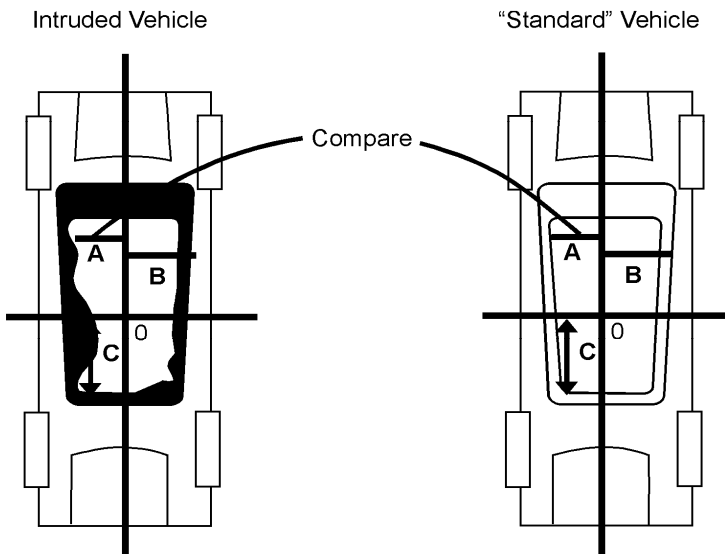

**FIGURE 2**

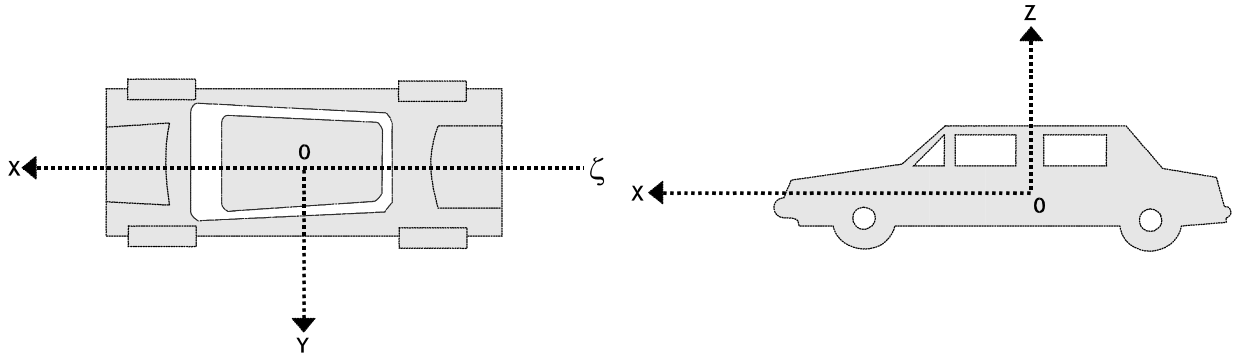

The x-axis is on the longitudinal centerline of the vehicle. This could be set up along the transmission drive shaft tunnel for a rear wheel drive vehicle or along a centerline which is equidistant from the sides of the vehicle in a front wheel drive vehicle.

The y-axis is in a side-to-side or lateral direction. This plane may be set up in any convenient location which can be readily established in the "reference" vehicle.

The z-axis is the vertical axis. A location at the top of the transmission drive shaft tunnel may be convenient to reference roof collapse in many cases. The point established by these intersecting planes defines the origin (**O**).

Establishing a frame of reference and measuring intrusion can be simplified.

- In a frontal collision, there is rarely intrusion at the rear, and vice-versa for a rear collision.
- Side impacts generally damage only one side of the vehicle.
- Roof impacts leave the floor pan undistorted.
- Not all intrusions require the establishment of all three axes.

The ordering of intrusions reflects the intrusion severity as recorded in column three (*i.e.*, Magnitude of Intrusion variables).

An intruded component is assessed for its Dominant Crush Direction as determined from the Magnitude of Intrusion. For example, an instrument panel may intrude both longitudinally and vertically. The coded intrusion will reflect the instrument panel with the dominant crush direction (vertical or longitudinally). If the dominant intrusion is not perceptibly different in the field (*i.e.*, an exemplar vehicle is required for comparison measurements) the Researcher should document the

component (i.e., instrument panel) in both directions. However, during the quality control process of the case, only the instrument panel intrusion with the greater magnitude is coded, the other intrusion row is deleted.

This system is defined by an orthogonal set of axes (x-y-z) and an origin (**O**) as shown in Figure 2. The position of the origin is typically on the longitudinal centerline of the vehicle and has an arbitrary location, both vertically and longitudinally. However, its location must be identical for the intruded and "reference" vehicle. Note, the axes are referenced to the floor plane of the vehicle.

**NOTE: The extent of a component intrusion into a row sector should not exceed the pre-impact dimension of that sector.** For example, if the front row width is 150 centimeters, each sector is equal to 50 centimeters. If the driver-side door panel intrudes 60 centimeters laterally, the intrusion is listed as:

Front Row Left (sector 11) Intrusion Magnitude = 50cm (maximum amount for that sector)

Front Row Middle (sector 12) Intrusion Magnitude = 10cm (the remaining amount for the door panel intrusion).

Catastrophic should only be used to describe intrusion damage which is so severe that the researcher is unable to discern any of the following:

- specific occupant locations,
- intruding components,
- magnitude of intrusions and dominant crush.

ROW WIDTHS

Interior Vehicle Form, Case 2007-996-900015/ Vehicle #1

INTEGRITY | GLAZING | INTRUSION | INSTRUMENT | STEERING | CONTACT | EJECTION | ENTRAPMENT | LOG | REVIEW

ROW WIDTHS | INTRUSIONS | DETAIL | SKETCH

Front Seat	<input type="text"/>	cm
Second Seat	<input type="text"/>	cm
Third Seat	<input type="text"/>	cm
Fourth Seat	<input type="text"/>	cm
Fifth Seat	<input type="text"/>	cm

Insert Save Close

**ROW WIDTHS**

**Screen Name:**

*SAS Data Set:* N/A

*SAS Variable:* N/A

*Oracle Name:* **INTRUSIONWIDTH.ROWWIDTH**

**Element Attributes:**

Oracle SAS

-9999 Record to the nearest centimeter  
Unknown

**Source:** Vehicle inspection

**Remarks:**

The interior space of a vehicle is divided into specific sectors as outlined in the following diagram. These sectors are based upon seat rows and **not** occupant seat locations. Cargo areas open to the passenger area (*i.e.*, station wagons, vans, etc.) are assessed in these variables. Intrusion into the trunk area of an automobile with a rear seat position or into a cargo area covered by a privacy curtain/shelf is excluded.

A vehicle row width is intended to capture the amount of lateral room available in the passenger compartment. However, the variety of designs incorporated in door and side panels makes it essential that row widths be measured at a uniform location. When obtaining a row width measurement:

1. Take the measurement at the beltline level, just below the greenhouse
2. Use a point longitudinally near the center of the door panel or side panel
3. Use an undamaged area of the door panel or side panel - if one side is damaged, a half-width measurement can be taken from the undamaged side, then doubled
4. Exclude any recessed or protruding components of the panel surface

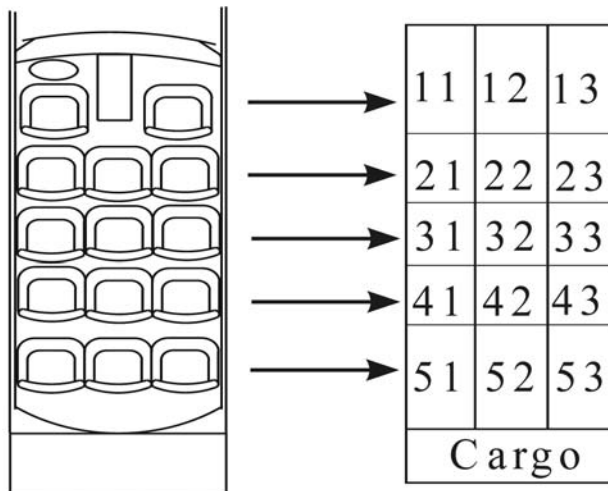



**INTERIOR VEHICLE FORM**  
**INTRUSIONS**

**INTRUSION**

Interior Vehicle Form, Case 2007-996-900015/ Vehicle #1

INTEGRITY | GLAZING | INTRUSION | INSTRUMENT | STEERING | CONTACT | EJECTION | ENTRAPMENT | LOG | REVIEW

ROW WIDTHS | INTRUSIONS | DETAIL SKETCH

Row	Position	Area	Intruded Component	Comparison	Intruded	Intrusion	Magnitude	Crush Direction
-----	----------	------	--------------------	------------	----------	-----------	-----------	-----------------

**INTRUSION DETAIL**

Interior Vehicle Form, Case 2007-996-900015/ Vehicle #1

INTEGRITY | GLAZING | INTRUSION | INSTRUMENT | STEERING | CONTACT | EJECTION | ENTRAPMENT | LOG | REVIEW

ROW WIDTHS | INTRUSIONS | DETAIL SKETCH

Row: [dropdown]  
Position: [dropdown]  
Intrusion Area: [dropdown]  
Intrusion Component: [dropdown]  
Comparison: [text]  
Intruded: [text]  
Intrusion: [text]  
Magnitude: [dropdown]  
Crush Direction: [dropdown]

**[INTRUSION NUMBER]**

**Screen Name:** N/A

**SAS Data Set:** *INTRSN*

**SAS Variable:** *INTNUM*

**Oracle Name:** *INTRUSION.OCCUPANTINTRUSIONNUMBER*

**Element Attributes:**

Automatically generated by data entry system, sequential numbers

**Source:** Vehicle inspection.

**Remarks:**

**ROW**

**Screen Name:** Row

**SAS Data Set:** N/A

**SAS Variable:** N/A

**Oracle Name:** *INTRUSION.PICKLOCATIONROW*

**Element Attributes:**

Oracle	SAS	
1	1	Front Row
2	2	Second Row
3	3	Third Row
4	4	Fourth Row
28627	5	Fifth Row
5	97	Catastrophic
8	8	Multiple/Other severe intrusions
6	98	Other
7	99	Unknown

**Source:** Vehicle inspection.

**Remarks:**

The interior space of a vehicle is divided into specific sectors as outlined in the following diagram. These sectors are based upon seat rows and **not** occupant seat locations. Cargo areas open to the passenger area (*i.e.*, station wagons, vans, etc.) are assessed in these variables but are not divided into sectors. Intrusion into the trunk area of an automobile with a rear seat position or into a cargo area covered by a privacy curtain/shelf is excluded.

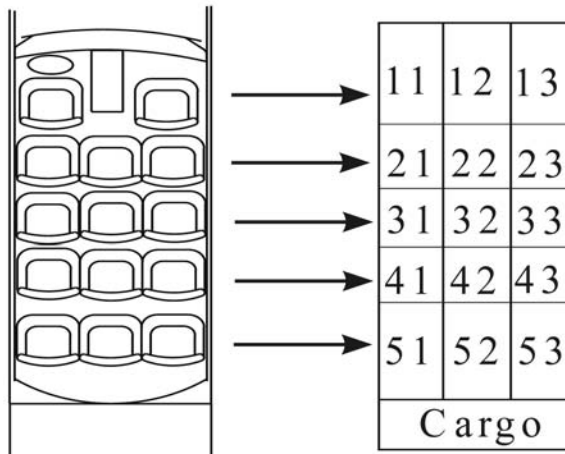

Row (cont'd)

Page 2 of 3

Front Row, Second Row, Third Row, Fourth Row and Fifth Row are identified by the presence of an installed seat. When the entire seat row is folded down or removed prior to the crash, this area is considered an **Other** enclosed area.

The following rules guide us in the determination of "seat rows" versus "other enclosed areas" and in the derivation of the lateral dimension of each row sector.

Cargo areas in passenger cars which are separated from the passenger compartment are not considered for intrusion. This would include trunk areas and rear cargo areas of hatchbacks and station wagons which were covered by a privacy curtain/shelf. The area above the seating rows is considered for intrusion and would be listed under **Other** enclosed area.

The area behind the front row of a pickup truck where jump seats are installed should be identified by the status of these seats prior to the crash. When at least one seat was in the operational mode (*i.e.*, open) at the time of the crash, the entire area is listed as row 2. Otherwise, this area is assessed under **Other** enclosed area.

A problematic area in vans is the situation where a row was removed prior to the crash. A seat row area that was removed prior to an crash should be selected as an **Other** enclosed area; however, it should be tabulated as a seat row to identify any sequential rows.

Vans with single seating positions behind the Front Row (usually high back swivel chairs) are compressed into a single seat row.

### **Catastrophic**

is used when the intrusion damage to the occupant compartment is so severe that none of this vehicle's seat positions can be referenced to any of the following: specific occupant locations, intruding components, magnitude of intrusions, or dominant crush. When catastrophic is selected, the program automatically encodes the **Area** as "other"; the **Magnitude** as "Catastrophic"; and the **Crush Direction** as "Catastrophic". **The Researcher must** select the **Intruded Component** as "Catastrophic"; **AND** leave the columns for **Comparison**, **Intruded**, and **Intrusion** blank.

### **Multiple/Other Severe Intrusions**

is used when passenger compartment intrusion is severe in multiple locations and when some intrusions can be fully or partially documented, but other intrusions are suspected and cannot be identified. At least one partial or complete intrusion must be coded when **Multiple/Other Severe Intrusions** is selected and this selection must be the last coded line of intrusion.

Row (cont'd)

Page 3 of 3

**Other**

is used for the following situations:

- Cargo areas open to the passenger area (i.e., station wagons, vans, etc.)
- When the entire seat row is folded down to the floor level or removed prior to the crash.

When **Other** is used to describe either of the situations above, that area is regarded as one sector and is not divided into the three sectors used for rows with seats.

**Unknown**

is used for the following situations:

- The researcher cannot determine if there was any intrusion.
- The vehicle was under repair (or repaired) at the time of inspection.

POSITION

Screen Name: Position

SAS Data Set: N/A

SAS Variable: N/A

Oracle Name: INTRUSION.PICKLOCATIONPOSITION

Element Attributes:

Oracle	SAS	
1	1	Left
2	2	Middle
3	3	Right
5	5	Cargo
6	97	[Catastrophic]
4	88	[Multiple/Other severe intrusions]
99	99	Unknown

Source: Vehicle inspection.

Remarks:

Each row is equally divided into three sectors regardless of the seating configuration.

In the situation where half of the row is folded down (i.e., split back seats) to accommodate cargo, the entire lateral area (wall-to-wall) is divided into three equal sectors.

The following rules guide us in the determination of "seat rows" versus "other enclosed areas" and in the derivation of the lateral dimension of each row sector.

The lateral occupant space dimension for the front seat row is obtained by measuring the distance from the vehicle's side-surface to side-surface (undamaged dimension) and dividing by three. **Note, there is no implied correlation between seating capacity and sectors.**

The area behind the front row of a pickup truck where jump seats are installed should be identified by the status of these seats prior to the crash. When at least one seat was in the operational mode (i.e., open) at the time of the crash, the entire area is divided into three sectors.

Left

is defined as the left sector of the row (i.e., sectors 11, 21, 31, 41, 51). The lateral dimension of this area is mathematically determined by dividing the original wall-to-wall dimension by three.

Position (cont'd)

Page 2 of 2

**Middle**

is defined as the center sector of the row (i.e., sectors 12, 22, 32, 42, 52).

**Right**

is defined as the right sector of the row (i.e., sectors 13, 23, 33, 43, 53).

**Cargo**

is defined as an entire seat row without seats or an area behind a seat row that is open to the passenger compartment. This area is not divided into three sections.

**[INTRUSION LOCATION]**

**Screen Name:** N/A

**SAS Data Set:** *INTRSN*

**SAS Variable:** *INLOC*

**Oracle Name:** *INTRUSION.PICKLOCATIONROW and  
PICKLOCATIONPOSITION*

**Element Values:**

**Front Row**

- 11 Left
- 12 Middle
- 13 Right

**Second Row**

- 21 Left
- 22 Middle
- 23 Right

**Third Row**

- 31 Left
- 32 Middle
- 33 Right

**Fourth Row**

- 41 Left
- 42 Middle
- 43 Right

**Fifth Row**

- 51 Left
- 52 Middle
- 53 Right

**Source:** Vehicle inspection.

**Remarks:**

The interior space of a vehicle is divided into specific sectors as outlined in the following diagram. These sectors are based upon seat rows and **NOT OCCUPANT SEAT LOCATIONS**. Cargo areas open to the passenger area (*i.e.*, station wagons, vans, etc.) are assessed in these variables.



Intrusion into the trunk area of an automobile with a rear seat position or into a cargo area covered by a privacy curtain/shelf is excluded.

11	12	13
21	22	23
31	32	33
41	42	43
51	52	53

When the entire seat row is folded down or removed prior to the crash, this area is considered an **Other** enclosed area.

The following rules guide us in the determination of "seat rows" versus "other enclosed areas" and in the derivation of the lateral dimension of each row sector.

Cargo areas in passenger cars which are separated from the passenger compartment are not considered for intrusion. This would include trunk areas and rear cargo areas of hatchbacks and station wagons which were covered by a privacy curtain/shelf. The area above the privacy curtain/shelf is considered for intrusion and would be listed under **Other** enclosed area.

The area behind the front row of a pickup truck where jump seats are installed should be identified by the status of these seats prior to the crash. When at least one seat was in the operational mode (*i.e.*, open) at the time of the crash, the entire area is listed as row 2. Otherwise, this area is assessed under **Other** enclosed area.

A problematic area in vans is the situation where a row was removed prior to the crash. A seat row area that was removed prior to an crash should be selected as an **Other** enclosed area; however, it should be tabulated as a seat row to identify any sequential rows.

**Catastrophic**

is used when the intrusion damage to the occupant compartment is so devastating that the researcher is not able to discern any of the following: specific occupant locations, intruding components, magnitude of intrusions, and dominant crush. When catastrophic is selected, the program automatically encodes the **Area** as “other”; the **Magnitude** as “Catastrophic”; and the **Crush Direction** as “Catastrophic”. **The Researcher must** select the **Intruded Component** as “Catastrophic”; **AND** leave the columns for **Comparison**, **Intruded**, and **Intrusion** blank.

**Other (Specify):**

is an area where no defined row exists. This would include an area where the entire seat row was folded down prior to the crash. Occasionally, the middle seat row in a passenger van will be removed leaving only the front and rearmost seat rows. If intrusion occurs within this area, the location should be identified here and specified.

**Unknown**

is used for the following situations:

- The researcher cannot determine if there was any intrusion.
- The vehicle was under repair (or repaired) at the time of inspection.

**AREA**

**Screen Name:** Area

**SAS Data Set:** N/A

**SAS Variable:** N/A

**Oracle Name:** *INTRUSION.PICKINTRUDINGCOMPCLASS*

**Element Attributes:**

Oracle	SAS	
1		Interior Components
2		Exterior Components
3		Other
4		[Multiple/Other severe intrusions]
7		[Catastrophic]

**Source:** Vehicle inspection.

**Remarks:**

This variable filters the forthcoming intruding components with respect to whether they were internal or external to the occupant compartment.

**INTRUDED COMPONENT**

**Screen Name:** Intruded Component

**SAS Data Set:** *INTRSN*

**SAS Variable:** *INCOMP*

**Oracle Name:** *INTRUSION.PICKINTRUDINGCOMPONENT*

**Element Attributes:**

Oracle	SAS	Oracle	SAS
	<b>Interior Components</b>		<b>Interior components cont'd</b>
1	1 Steering assembly	20	20 Front seat back
2	2 Instrument panel left	21	21 Second seat back
3	3 Instrument panel center	22	22 Third seat back
4	4 Instrument panel right	23	23 Fourth seat back
5	5 Toe pan	24	24 Fifth seat back
6	6 A (A1/A2)-pillar	25	25 Seat cushion
7	7 B-pillar	26	26 Back door/panel (e.g., tailgate)
8	8 C-pillar		
9	9 D-pillar	27	27 Other interior component (specify):
10	10 Side panel - forward of the A1/A2-pillar	35	35 Door/Forward upper quadrant
12	12 Side panel - rear of the B-pillar	36	36 Door/Forward lower quadrant
13	13 Roof (or convertible top)	37	37 Door/Rear upper quadrant
14	14 Roof side rail	38	38 Door/Rear lower quadrant
15	15 Windshield	41	41 Door-Undetermined Location
16	16 Windshield header		<b>Exterior Components</b>
17	17 Window frame	28	30 Hood
18	18 Floor pan (includes sill)	29	31 Outside surface of this vehicle (specify):
19	19 Backlight header	30	32 Other exterior object in the environment (specify):
		31	33 Unknown exterior object
		32	34 Grab Handles
			97 [Catastrophic]
			<b>Other Component</b>
		40	96 [Multiple/Other severe intrusions]
		33	98 Intrusion of exterior unlisted component(s)

**Source:** Vehicle inspection.

**Remarks:**

Select the component which has reduced the occupant space for that sector. An intruded component is assessed for its Dominant Crush Direction as determined from the Magnitude of Intrusion. For example, an instrument panel may intrude both longitudinally and vertically. The final coded intrusion will reflect the instrument panel with the dominant crush direction (vertical or longitudinally). If the dominant intrusion cannot be determined in the field (i.e., an exemplar vehicle is required for comparison measurements) the Researcher should document the component (i.e., instrument panel) in both directions. However, during final completion of the case, only the instrument panel intrusion with the greater magnitude is coded, the other intrusion row is deleted.

**INTERIOR COMPONENTS:**

**Steering assembly**

consists of the entire steering column which includes the steering rim, hub, and spokes.

**Instrument panel left**

refers to the left one-third of the panel. This should correlate with the same lateral dimension generated for the sector "11" (Front Seat Left) in variables Row and Position.

**Instrument panel center**

refers to the center one-third area of the instrument panel. This should correlate with the same lateral dimension generated for the sector "12" (Front Seat Middle) in variable Row and Position.

**Instrument panel right**

refers to the right one-third of the instrument panel. This should correlate with the same lateral dimension generated for the sector "13" (Front Seat Right) in variables Row and Position.

**Toe pan**

refers to the front portion of the floor that angles up to meet the dash panel.

**A (A1/A2)-pillar**

refers to the upper and lower portion of the forward most structural post of the passenger compartment on both side planes. Some vehicles (e.g., GM APV minivan) are designed with two upper A-pillars on each side. The forward most pillar is called an A1-pillar which is primarily designed to secure the windshield to the vehicle. The second pillar is labeled as an A2-pillar. This pillar generally lends support to the roof and also helps to establish the front door opening. Annotation should be provided on the Interior Vehicle Form specifying which pillar was most severely intruded.

**B-pillar**

refers to the upper and lower portion of the structural post located at the rear edge of the front doors on both side planes. It should be noted, some vehicles do not have upper B-pillars.

**C-pillar**

refers to the upper and lower portion of the structural side post located at the rearmost edge of the rear door of a four door vehicle or the upper portion of the structural side post located between the backlight and side window glass on two door vehicles.

**D-pillar**

refers to the upper and lower portion of the structural post rearward of the C-pillar. D-pillars are usually available on station wagons, vans, or utility vehicles. The D-pillar is not to be confused with the C-pillar which is the rearmost pillar of the passenger compartment on most two and four door vehicles.

**Side panel forward of the A1/A2-pillar**

refers to the interior panel located on the side of the vehicle and forward of the front doors. This includes areas directly below the instrument panel sometimes referred to as a "kickpanel". See **A-pillar** for A1/A2 definition.

**Side panel rear of the B-pillar**

refers to any side surface area excluding doors, window frames, and associated glazing rearward of the B-pillar, below the roof rail, above the sill, and in front of any back door or wall.

**Roof (or convertible top)**

refers to the top structural member of the greenhouse supported by the side pillars, windshield header and backlight header.

**Roof side rail**

refers to the longitudinal horizontal stiffeners located along the edge of the roof.

**Windshield**

refers to the lateral glazing located at the forward most surface of the greenhouse.

**Windshield header**

refers to the front forward lateral edge of the roof directly above the windshield.

**Window frame**

refers to the longitudinal frame that encloses the side window glazings and composes that portion of the door above the window sill.

**Floor pan (includes sill)**

refers to the floor of the vehicle. This includes the lower portion of the passenger compartment (*e.g.*, door sills).

**Backlight header**

refers to the rear most lateral edge of the roof directly above the backlight.

**Front seat back**

refers to the back support of the front seat.

**Second seat back**

refers to the back support of any second-row seat.

**Third seat back**

refers to the back support of any third-row seat.

**Fourth seat back**

refers to the back support of any fourth-row seat.

**Fifth seat back**

refers to the back support of any fifth-row seat.

**Seat cushion**

refers to the horizontal portion of the seat assembly that was designed for seating.

**Back door/panel (*e.g.*, tailgate)**

refers to the interior surface and related components of the back door or if no door exists, the interior surface of the back wall.

**Other interior component**

refers to any interior component that may intrude into an occupant seating position.

**Door/Forward upper quadrant/lower quadrant**

The doors are visually divided into quadrants. The longitudinal measurement is taken at the beltline along the window frame. The vertical measurement is taken at the midpoint of the door, from the top edge to the bottom edge of the inner door panel.

The quadrants are rarely equal in size. They are named as follows: Forward Upper Quadrant (FUQ), Forward Lower Quadrant (FLQ), Rear Upper Quadrant (RUQ), and Rear Lower Quadrant (RLQ). Select the quadrant that best represents the most intruded quadrant of the door. Only one quadrant can be selected per door.

**Door/Rear upper quadrant/lower quadrant**

The doors are visually divided into quadrants. The longitudinal measurement is taken at the beltline along the window frame. The vertical measurement is taken at the midpoint of the door, from the top edge to the bottom edge of the inner door panel.

The quadrants are rarely equal in size. They are named as follows: Forward Upper Quadrant (FUQ), Forward Lower Quadrant (FLQ), Rear Upper Quadrant (RUQ), and Rear Lower Quadrant (RLQ). Select the quadrant that best represents the most intruded quadrant of the door. Only one quadrant can be selected per door.

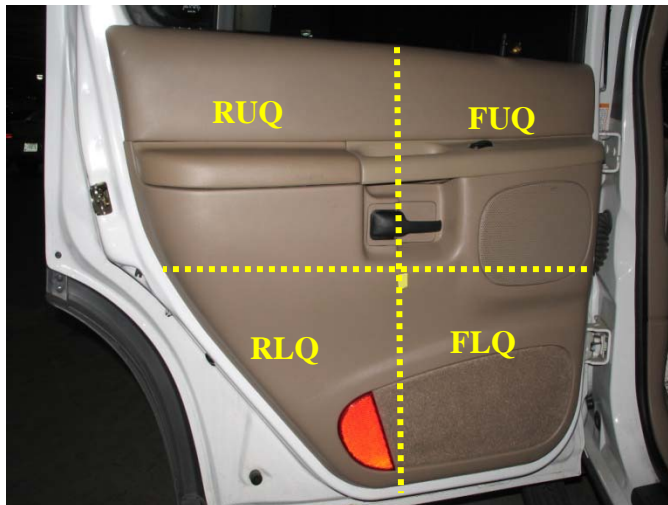

**EXTERIOR COMPONENTS:**

**Hood**

refers to the horizontal structure covering the front compartment of the vehicle located forward of the windshield.

**Outside surface of this vehicle**

is selected when any outside surface of this vehicle not mentioned above has violated the internal boundary surface of the passenger compartment (*e.g.*, spare tire, jack, outside mirror, etc.).

**Other exterior object in the environment**

refers to an object external to the vehicle (trees, poles, other vehicle, etc.) which penetrates the internal boundary of this vehicle.

**Unknown exterior object**

is selected if there is evidence that an object intruded but it's unknown what that object was.

**Intrusion of exterior unlisted component(s)**

is used if there is intrusion of any component not listed above.



**COMPARISON VALUE (OF INTRUSION)**

**Screen Name:** Comparison

**SAS Data Set:** N/A

**SAS Variable:** N/A

**Oracle Name:** *INTRSION.COMPARISONVALUE*

**Element Attributes:**

Oracle SAS

Record to the nearest centimeter

[Catastrophic]

-9999

[Unknown]

**Source:** Vehicle inspection.

**Remarks:**

Follow the instructions for determining vehicle intrusions, establishing axes, and determining comparison values found in **Occupant Area Intrusion Overview**.

Enter the Comparison value for the intruded component.

**INTRUDED VALUE (OF INTRUSION)**

**Screen Name:** Intruded

**SAS Data Set:** N/A

**SAS Variable:** N/A

**Oracle Name:** *INTRUSION.INTRUDEDVALUE*

**Element Attributes:**

Oracle SAS

-9999 Record to the nearest centimeter  
[Catastrophic]  
[Unknown]

**Range:**

**Source:** Vehicle inspection.

**Remarks:**

Follow the instructions for determining vehicle intrusions, establishing axes, and determining intruded values found in **Occupant Area Intrusion Overview**.

Enter the Comparison value for the intruded component.

**INTRUSION**

**Screen Name:** Intrusion

**SAS Data Set:** *INTRSN*

**SAS Variable:** *INMEAS*

**Oracle Name:** *INTRUSION.INTRUSION*

**Element Attributes:**

Oracle	SAS	
		Record to the nearest centimeter
-8861	977	[Catastrophic]
-9999	999	[Unknown]

**Source:** Vehicle inspection.

**Range:** 1-160, 997(catastrophic), 999 (unknown)

**Remarks:**

Follow the instructions for determining vehicle intrusions, establishing axes, and determining Intrusion values found in **Occupant Area Intrusion Overview**.

The Intrusion value is computed if the Researcher enters both an **Intruded** value and a **Comparison** value.

**The extent of a component intrusion into a row sector should not exceed the pre-impact dimension of that sector.** For example, if the front row width is 150 centimeters, each sector is equal to 50 centimeters. If the driver-side door panel intrudes 60 centimeters laterally, the intrusion is listed as:

Front Row Left (sector 11) Intrusion Magnitude = 50cm ( maximum amount for that sector)  
Front Row Middle (sector 12) Intrusion Magnitude = 10cm (the remaining amount for the door panel intrusion).

If the magnitude cannot be measured, but can be visibly seen, estimate the intrusion in the Magnitude variable that follows this variable.

**Unknown**

is used in the following situations.

- The researcher cannot determine if there was any intrusion.
- The vehicle was under repair at the time of inspection.
- The researcher was not able to measure or reasonably estimate the intrusion.

**MAGNITUDE OF INTRUSION**

**Screen Name:** Magnitude

**SAS Data Set:** *INTRSN*

**SAS Variable:** *INMAG*

**Oracle Name:** *INTRUSION.PICKINTRUDINGMAGNITUDE*

**Element Attributes:**

Oracle	SAS	
0	0	<= 2 cm
1	1	>= 3 cm but < 8 cm
2	2	>= 8 cm but < 15 cm
3	3	>= 15 cm but < 30 cm
4	4	>= 30 cm but < 46 cm
5	5	>= 46 cm but < 61 cm
6	6	>=61 cm
7	7	[Catastrophic]
9	8	[Multiple/Other Severe Intrusions]
8	9	[Unknown]

**Source:** Vehicle inspection.

**Remarks:**

When the **Intrusion** is calculated by the program, is automatically assigns a magnitude or range to the intrusion. The researcher may select a magnitude for an intruded component while awaiting comparison values. If the magnitude cannot be measured, due to physical limitations but can be visibly seen, estimate the magnitude of the intrusion.

**Unknown**

is used in the following situations:

- The researcher cannot determine if there was any intrusion.
- The vehicle was under repair at the time of inspection.
- The researcher was not able to measure or reasonably estimate the intrusion.

**CRUSH DIRECTION**

**Screen Name:** Crush Direction

**SAS Data Set:** *INTRSN*

**SAS Variable:** *CDRIR*

**Oracle Name:** *INTRUSION.PICKINTRUDINGDIRECTION*

**Element Attributes:**

Oracle	SAS	
1	1	Vertical
2	2	Longitudinal
3	3	Lateral
4	7	[Catastrophic]
	8	[Multiple/Other Severe Intrusions]
5	9	[Unknown]

**Source:** Vehicle inspection.

**Remarks:**

This variable assesses the direction of displacement for the intruded component. The direction of movement is determined independently from the PDOF applied to the vehicle.

**Vertical**

refers to components which intrude into the passenger compartment from either an upward or downward direction.

**Longitudinal**

refers to components which move forward or rearward into the passenger compartment.

**Lateral**

refers to components which are displaced either left or right within the passenger compartment.

**Unknown**

is used for the following situations:

- The researcher cannot determine if there was any intrusion.
- The vehicle was under repair at the time of inspection.

INTRUSION/SKETCH

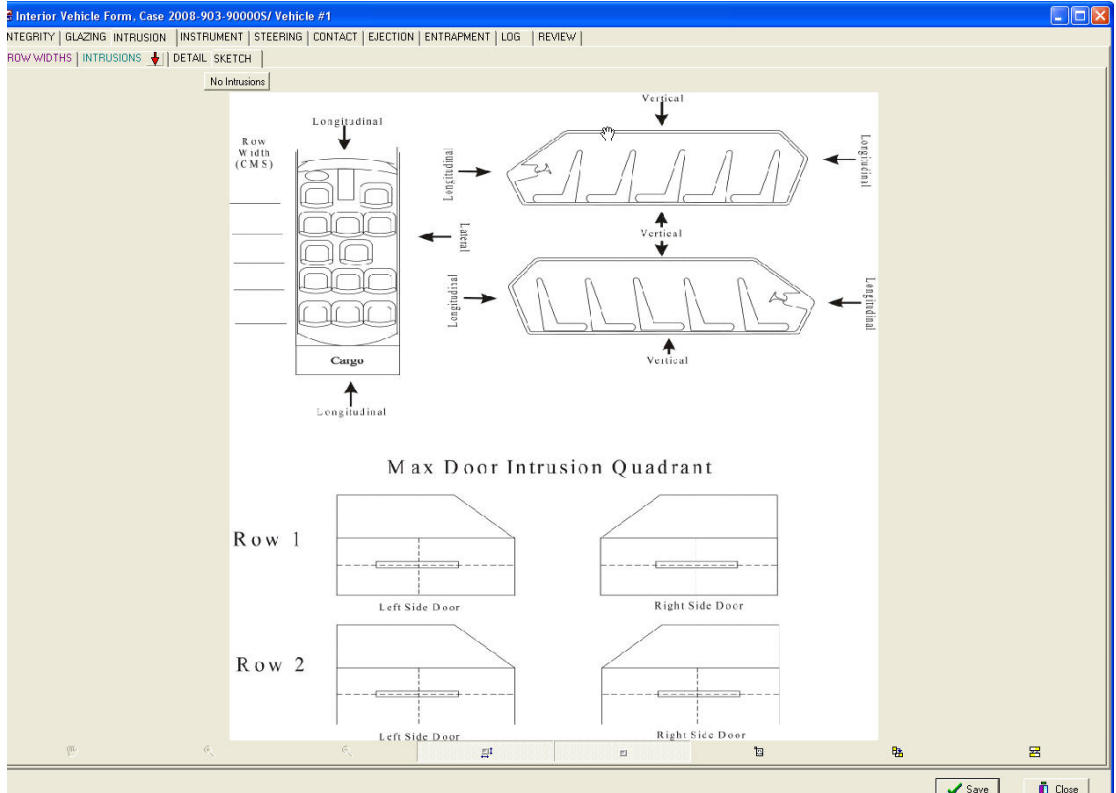

INTRUSION/SKETCH

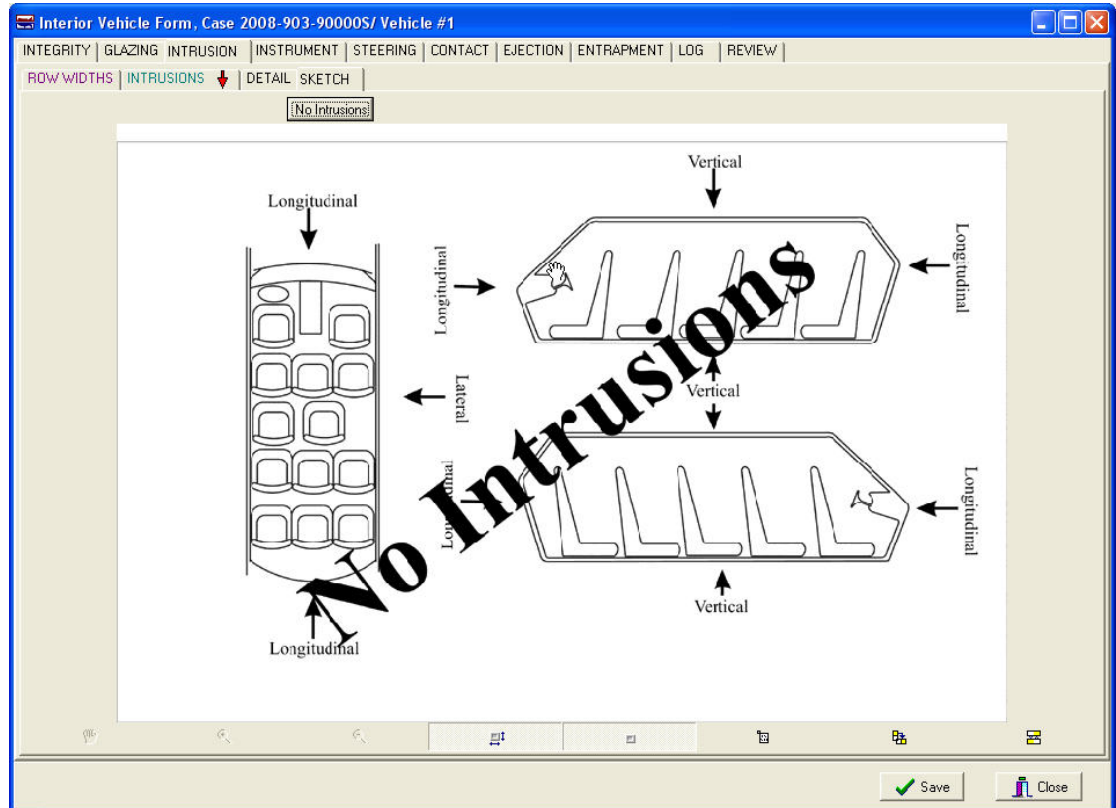

**INTRUSION SKETCH COMPLETION**

The following should be included for all intrusion sketches:

Row width for all rows in the vehicle.

Row widths are not required if no intrusions were observed.

A rough sketch of the Intruded components and their approximate displacement.

Cross out or erase rows which are not present in the vehicle.

Applicable annotations.

Max Door Intrusion Quadrant sketch:

Sketch the intruded component and indicate the amount of intrusion.

An example sketch is provided below:

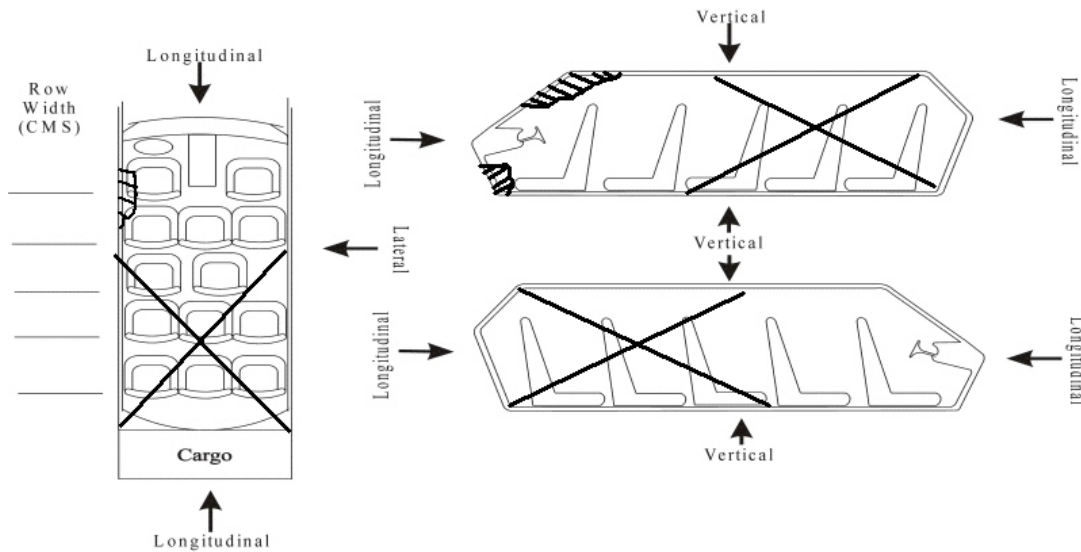

**Max Door Intrusion Quadrant**

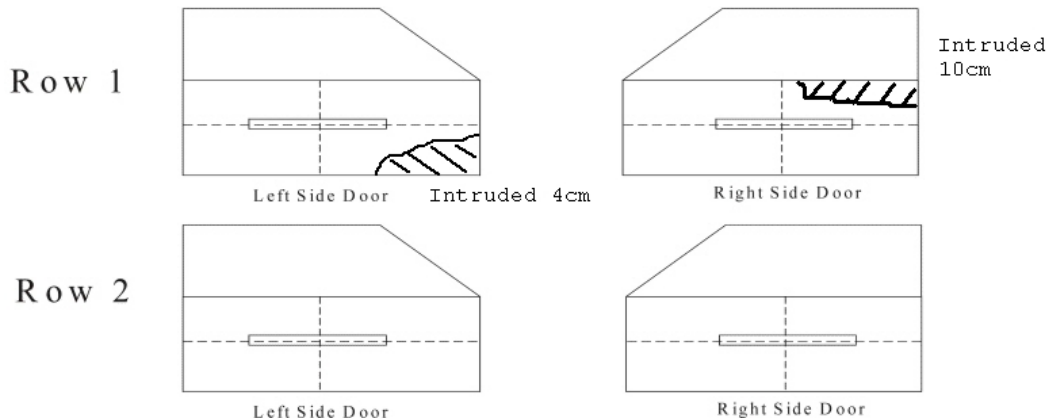

INSTRUMENT

Interior Vehicle Form, Case 2008-903-90000S/ Vehicle #1

INTEGRITY | GLAZING | INTRUSION | INSTRUMENT | STEERING | CONTACT | EJECTION | ENTRAPMENT | LOG | REVIEW

Odometer - Reading  kilometers

- Source  Adjustable Pedal

Adaptive Driving Equipment

Adaptive Equipment Right Mouse Click on Check Box to View Specify

<input type="checkbox"/> Hand Controls for braking/acceleration	<input type="checkbox"/> Wheelchair tie-downs	<input type="checkbox"/> Pedal Extender
<input type="checkbox"/> Steering control devices	<input type="checkbox"/> Modification to seat belts (specify)	<input type="checkbox"/> Unknown type of adaptive device
<input type="checkbox"/> Steering knob attached to steering wheel	<input type="checkbox"/> Additional or relocated switches (specify)	
<input type="checkbox"/> Low effort power steering (unit or device)	<input type="checkbox"/> Raised roof	
<input type="checkbox"/> Replacement steering wheel (i.e. reduced diameter)	<input type="checkbox"/> Wall mounted head rest (used behind wheel chair)	
<input type="checkbox"/> Joy-stick steering controls	<input type="checkbox"/> Other adaptive device (specify)	

Save Close



**ODOMETER READING**

**Screen Name:** Odometer Reading

**SAS Data Set:** VI

**SAS Variable:** ODOMETER

**Oracle Name:** INTERIORVEHICLE.ODOMETER

**Element Attributes:**

Oracle	SAS	
		Enter odometer reading
-8868		Unknown Electric Odometer
-9999	9999999	Unknown

**Range:** 000,001 through 1,000,000

**Source:** Primary source is the vehicle inspection, secondary sources include the interviewee, and repair facility.

**Remarks:**

Enter the number of miles displayed on the odometer.

This variable measures the distance the vehicle has traveled. However, in cases where it is known that the odometer was working but had turned over (*i.e.*, recycled) the recorded value represents the total distance traveled by the vehicle rather than the reading on the odometer. Annotate in **Odometer Source** the source of information when it is determined that the odometer had turned over.

**Unknown-Electric Odometer**

Use if odometer is electronic and the vehicle does not have a power supply.

**Unknown**

used when:

- it is known that the odometer was disconnected or broken before the collision;
- the vehicle is equipped with an electronic instrument cluster and an analog "back-up" odometer is not present; or
- the vehicle's odometer reading is unknown.
- the vehicle was manufactured without an odometer.

**ODOMETER SOURCE**

**Screen Name:** Odometer - - Source

**SAS Data Set:** *VI*

**SAS Variable:** *ODOMSRC*

**Oracle Name:** *INTERIORVEHICLE.PICKODOMETERSOURCE*

**Element Attributes:**

Oracle	SAS	
	0	[Unknown odometer reading]
1	1	Vehicle Inspection
2	2	Interview
3	3	Repair Facility
4	8	Other

**Source:** Primary source is the vehicle inspection; secondary sources include Interviewees and repair facilities

**Remarks:**

Indicate the source that was used to make the vehicle’s mileage determination. For example: if it is evident from the vehicle inspection that the vehicle has gone over 100,000 miles, and the odometer indicates 2,300 miles, code the mileage as 102,300 (164,636 kilometers) and indicate the source as **Vehicle Inspection**.

**ADJUSTABLE PEDALS**

**Screen Name:** Adjustable Pedal

**SAS Data Set:** VI

**SAS Variable:** ADJPED

**Oracle Name:** INTERIORVEHICLE.PEDALEXTENDID

**Element Attributes:**

Oracle	SAS	
1	1	No adjustable pedals
2	2	Full forward (toward toe pan)
3	3	Mid position
4	4	Full rearward (toward driver)
9	8	Position unknown
-9999	9	Unknown if present

**Source:** Investigator determined — primary source is the vehicle inspection, secondary source is driver interview.

**Remarks:**

**ADAPTIVE (ASSISTIVE) DRIVING EQUIPMENT**

**Screen Name:** Adaptive Driving Equipment

**SAS Data Set:** VI

**SAS Variable:** ADAPTEQ

**Oracle Name:** INTERIORVEHICLE.DRIVINGEQUIPEXIST

**Element Attributes:**

Oracle	SAS	
1	0	No adaptive driving equipment
2	1	Yes, adaptive driving equipment installed, check all that apply
3	9	Unknown

**Source:** Investigator determined — primary source is the vehicle inspection, secondary source is driver interview.

**Remarks:**

Adaptive driving equipment is defined as equipment whose primary purpose is to assist persons with disabilities in the operation of a vehicle. This variable is designed to capture those vehicles that have this type of after-market adaptive driving equipment installed. Use of the equipment at the time of the crash is irrelevant. Be alert for evidence of equipment that may have been removed between the time of the crash and the time of inspection. The device(s) must be present at the driving position (e.g., wheelchair tie downs).

**No adaptive driving equipment**

is used when it is determined that no adaptive equipment was present in the vehicle at the time of the crash.

**Yes, adaptive driving equipment installed, check all that apply**

is used when it is determined that adaptive equipment was present in the vehicle at the time of the crash. Use of the equipment at the time of the crash is not to be considered.

**Unknown**

is used when it cannot be determined if any adaptive driving devices were installed in the vehicle at the time of the crash.

**ADAPTIVE (ASSISTIVE) DRIVING EQUIPMENT**

**Screen Name:** Adaptive Driving Equipment

**SAS Data Set:** *ADAPTEQ*

**SAS Variable:** *EQUIPTYP*

**Oracle Name:** *VEHICLEADAPTIVEEQUIPMENT.ADAPTIVEEQUIPID*

**Element Attributes:**

Oracle	SAS	
1	1	Hand controls for braking/acceleration
2	2	Steering control devices (attached to OEM steering wheel)
3	3	Steering knob attached to steering wheel
4	4	Low effort power steering (unit or device)
5	5	Replacement steering wheel ( <i>i.e.</i> reduced diameter)
6	6	Joy-stick steering controls
7	7	Wheelchair tie-downs
8	8	Modifications to seat belts (specify)
9	9	Additional or relocated switches (specify)
10	10	Raised roof
11	11	Wall mounted head rest (used behind wheelchair)
13	12	Pedal extender
12	98	Other adaptive device (specify)
99	99	Unknown type of adaptive device
		Unknown if adaptive driving equipment installed

**Source:** Investigator determined — primary source is the vehicle inspection, secondary source is driver interview.

**Remarks:**

Adaptive driving equipment is defined as equipment whose primary purpose is to assist persons with disabilities in the operation of a vehicle. This variable is designed to capture those vehicles that have this type of after-market adaptive driving equipment installed. Use of the equipment at the time of the crash is irrelevant. Be alert for evidence of equipment that may have been removed between the time of the crash and the time of inspection. The device(s) must be present at the driving position (e.g., wheelchair tie downs).

**ADAPTIVE EQUIPMENT INSTALLED, CHECK ALL THAT APPLY**

is used when it is determined that adaptive equipment was present in the vehicle at the time of the crash. Use of the equipment at the time of the crash is not to be considered.

**Hand controls for braking/acceleration**

does not include normal cruise control.

**Steering control devices (attached to OEM steering wheel)**

includes handles and arms used to assist in the operation of the vehicle.

**Steering knob attached to steering wheel**

is used to help in the turning of the vehicle. May sometimes be referred to as a "suicide knob".

**Low effort power steering (unit or device)**

can possibly be identified by looking under the hood for an enhanced pump.

**Replacement steering wheel (i.e. reduced diameter)**

some after-market suppliers have "chain-link" type steering wheels, they are **NOT** considered as adaptive equipment for persons with disabilities.

**Joy-stick steering controls****Wheelchair tie-downs**

are selected **ONLY** if they are present at the drivers' location.

**Modifications to seat belts (specify)**

comfort devices such as lambs wool coverings are **NOT** considered here.

**Additional or relocated switches (specify)****Raised Roof**

will look like a second roof, not a camper-van type

**Wall mounted head rest (used behind wheelchair)**

are selected **ONLY** if they are present at the drivers' location

**Other adaptive device (specify)**

must be specified and sketched if possible. As an example, after-market pedal extenders used specifically for assist persons with disabilities in the operation of the foot controls would be included in this element.

**Unknown type of adaptive device**

is used when it is known there is an adaptive device for the driver, but the type of device is unknown

STEERING COLUMN

Interior Vehicle Form, Case 2007-996-900015/ Vehicle #1

INTEGRITY | GLAZING | INTRUSION | INSTRUMENT | STEERING | CONTACT | EJECTION | ENTRAPMENT | LOG | REVIEW

STEERING COLUMN | WORKSHEET | DRAWING

Column Type

Tilt Adjustment

Telescoping Adjustment

Location of Rim/Spoke Deformation

Rim/Spoke Deformation (cms)

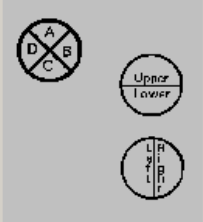

Save Close

**STEERING COLUMN TYPE**

**Screen Name:** Column Type

**SAS Data Set:** VI

**SAS Variable:** COLUMTYP

**Oracle Name:** INTERIORVEHICLE.PICKTYPEOFCOLUMN

**Element Attributes:**

Oracle	SAS	
1	1	Fixed column
2	2	Tilt column
3	3	Telescoping column
4	4	Tilt and telescoping column
5	8	Other column type (specify):
6	9	Unknown

**Source:** Vehicle inspection.

**Remarks:**

**Fixed column**

refers to a non-adjustable steering column. Note if “Fixed column” is selected the variables **Tilt Adjustment** and **Telescoping Adjustment** will be pre-coded as “No tilt steering column” and “No telescoping column”, respectively.

**Tilt column**

refers to a steering column designed to allow the steering wheel or column to be tilted at an angle selected by the operator to improve driving comfort. The presence of these types can generally be verified by the existence of an extra control stalk on the column. This stalk is separate from the turn signal, headlight, or wiper controls and is usually mounted near the bend point of the tilt wheel, or near the lower part of the instrument panel for the tilt column. Characteristically, the control stalk is unmarked and may be located on the left or right side of the column in relative proximity to the steering wheel end. Some vehicles are equipped with a “lever” device on the underside of the column, which allows placement of the entire column for driver comfort.

**Telescoping column**

refers to a steering column that has an adjustable length. The column can be shortened or lengthened to suit operator comfort. The telescoping feature can generally be identified by the presence of a knurled ring around the column. Rotating this ring allows the column to be lengthened or shortened, while re-tightening the ring locks the column at the desired adjustment.



Column Type (cont'd)

Page 2 of 2

**Tilt and telescoping column**

refers to a column that has both the tilt wheel and adjustable length features.

**Other column type (specify)**

includes steering columns which cannot be described above. This would include swing away columns, etc.

**Unknown**

Unknown is used if the column type cannot be determined.

**TILT STEERING COLUMN ADJUSTMENT**

Page 1 of 2

**Screen Name:** Tilt Adjustment

**SAS Data Set:** VI

**SAS Variable:** COLMTILT

**Oracle Name:** INTERIORVEHICLE.PICKTILTADJUSTCOLUMN

**Element Attributes:**

Oracle	SAS	
1	0	[No tilt steering column]
2	1	Full up
3	2	Between full up and center
4	3	Center
5	4	Between center and full down
6	5	Full down
7	9	Unknown

**Source:** Investigator determined; primary source is the vehicle inspection, other input is driver interview.

**Remarks:**

This variable is used to describe the pre-impact tilt position of adjustable steering columns.

**Full up**

refers to a vertically adjustable steering column that was in its highest position possible at the time of the crash.

**Between full up and center**

refers to a vertically adjustable steering column that was somewhere between full up and the center position at the time of the crash.

**Center**

refers to a vertically adjustable steering column that was in the center-most position (*e.g.* equal amounts of adjustment both above and below this position) at the time of the crash.

**Between center and full down**

refers to a vertically adjustable steering column that was somewhere between the center and full down position at the time of the crash.

**Full down**

refers to a vertically adjustable steering column that in its lowest possible position at the time of the crash.

**Unknown**

is selected when: it cannot be determined if the vehicle was equipped with a vertically adjustable steering column or the researcher cannot determine the pre-impact position of the vertically adjustable steering column.

**TELESCOPING STEERING COLUMN ADJUSTMENT**

**Screen Name:** Telescoping Adjustment

**SAS Data Set:** VI

**SAS Variable:** COLMTELE

**Oracle Name:** INTERIORVEHICLE.PICKTELEADJUSTCOLUMN

**Element Attributes:**

Oracle	SAS	
1	0	[No telescoping steering column]
2	1	Full back
3	2	Between full back and midpoint
4	3	Midpoint
5	4	Between midpoint and full forward
6	5	Full forward
7	9	Unknown

**Source:** Investigator determined; primary source is the vehicle inspection, other input is driver interview.

**Remarks:**

This variable is used to describe the pre-impact telescoping position of adjustable steering columns.

**No telescoping steering column**

is selected when the steering column does not have an adjustment to move the steering column/wheel longitudinally (forward and backward).

**Full back**

refers to a longitudinally adjustable steering column that was in its rearward-most position (toward the rear of the vehicle) at the time of the crash.

**Between full back and midpoint**

refers to a longitudinally adjustable steering column that was somewhere between the full back position (toward the rear of the vehicle) and the center position at the time of the crash.

**Midpoint**

refers to a longitudinally adjustable steering column that was in the center-most position (mid-point of the overall movement range) at the time of the crash.

**Between midpoint and full forward**

refers to a longitudinally adjustable steering column that was somewhere between the center position and the full forward position (toward the front of the vehicle) at the time of the crash.

**Full forward**

refers to a longitudinally adjustable steering column that was in the forward most position (toward the front of the vehicle) at the time of the crash.

**Unknown**

is selected when it cannot be determined if the vehicle was equipped with a longitudinally adjustable steering column or the researcher cannot determine the pre-impact position of the longitudinally adjustable steering column.

**LOCATION OF RIM/SPOKE DEFORMATION**

**Screen Name:** Location of Rim / Spoke Deformation

**SAS Data Set:** VI

**SAS Variable:** RDEFLOC

**Oracle Name:** INTERIORVEHICLE.PICKLOCSTEERRIMDEF

**Element Attributes:**

Oracle	SAS	
1	0	No steering rim deformation

**Quarter Sections**

2	1	Section A
3	2	Section B
4	3	Section C
5	4	Section D

**Half Sections**

6	5	Upper half of rim/spoke
7	6	Lower half of rim/spoke
8	7	Left half of rim/spoke
9	8	Right half of rim/spoke
10	9	Complete steering wheel collapse
11	10	Undetermined location
12	99	Unknown

**Source:** Vehicle inspection.

**Remarks:**

The variable **Rim / Spoke Deformation** must be coded with a value, in order to classify the **Location of Rim / Spoke Deformation**.

The steering wheel rim is divided into four quarter sections (A through D) and four half sections (upper half, lower half, left half, right half).

**Note**, the half designation should not be considered as a grouping of quarter sections.

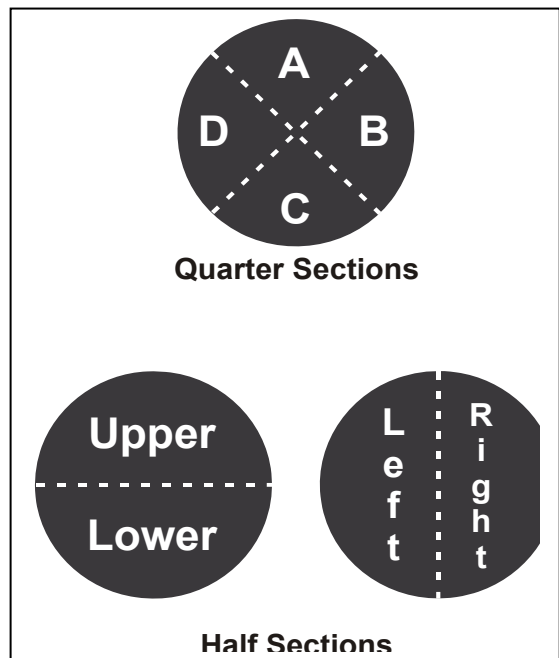

The accompanying diagrams identify the location of the quarter and half sections.

Evaluate the deformation of the rim with respect to the wheel design and not the wheel position observed during the vehicle inspection. For example, if the designed top section was deformed and rotated to the bottom position, then the correct response for this variable is Quarter Sections - Section A; see below.

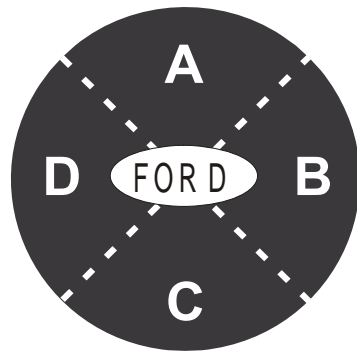

**Straight Ahead Position**

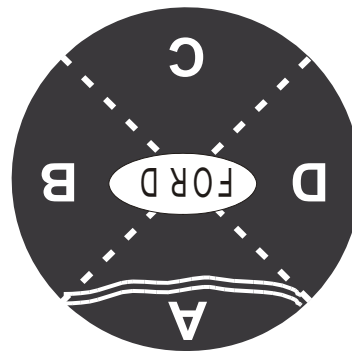

**Post-Impact Position**

When evaluating which quarter or half to encode, place primary emphasis upon downward deflection (toward the instrument panel) since the coding captures occupant-caused deformation. When two half sections are deformed, select the half with the greatest deformation.

**Complete steering wheel collapse**

is selected in the event two half sections are deformed axially downward (toward the instrument panel) beyond the hub.

**Undetermined location**

is selected when it is known the rim was deformed, but as the result of extrication or other post-impact activity the original deformed section could not be determined.

**Unknown**

is selected in the following situations:

- It is not known if the rim was deformed by occupant contact.
- An assessment of rim damage could not be made as the vehicle was repaired.

**STEERING RIM/SPOKE DEFORMATION**

**Screen Name:** Rim /Spoke Deformation

**SAS Data Set:** VI

**SAS Variable:** RIMDEF

**Oracle Name:** INTERIORVEHICLE.PICKSTEERRIMDEF

**Element Attributes:**

Oracle	SAS	
-8887		Record actual measured deformation to the nearest centimeter [Not applicable]
-8888	98	Indeterminate
-9999	99	Unknown

**Source:** Vehicle inspection.

**Range:** 0-20, 98, 99

**Remarks:**

The intent is to capture deformation caused by occupant contact rather than induced damage.

The center of the steering wheel hub is the reference plane for determining magnitude of deformation. A measurement is taken from this reference plane to that area of the rim which has the greatest deformation. This measurement should be referenced to an undisplaced area of the rim or compared to the rim of a similar undamaged vehicle.

The following diagram illustrates this measurement procedure. The undeformed edge is 8 centimeters from the reference line. The deformed edge is 5 centimeters from the reference line. Therefore, 3 centimeters of deformation occurred.

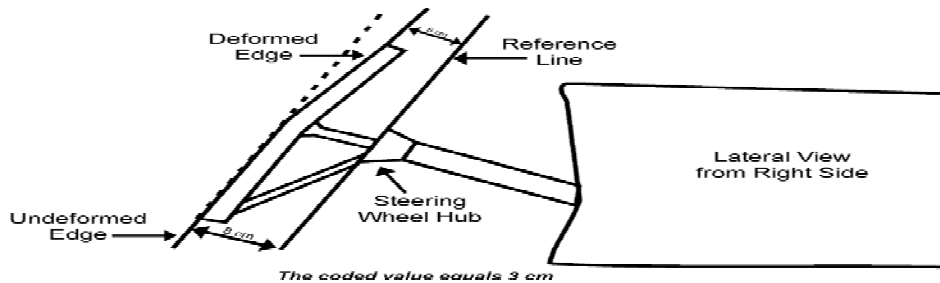



**Value of Zero**

is entered when there was no deformation caused by occupant contact of the rim or spokes. Check your observation by placing a flat object (*i.e.*, clipboard) across the plane of the steering rim prior to selecting this attribute.

**Value of 1**

is entered when the deformation is greater than zero but less than 1.5 centimeters.

**Indeterminate**

is selected when the situation does not permit the direct measurement of a deformed rim.

**Unknown**

is selected in the following situations:

- It is not known if the rim was deformed by occupant contact.
- An assessment of rim damage cannot be made because the vehicle is repaired.

STEERING/WORKSHEET

Interior Vehicle Form, Case 2007-996-900015/ Vehicle #1

INTEGRITY | GLAZING | INTRUSION | INSTRUMENT | **STEERING** | CONTACT | EJECTION | ENTRAPMENT | LOG | REVIEW

STEERING COLUMN | **WORKSHEET** | DRAWING

	Comparison Value	Damage Value	Deformation
*	0	0	0

Save Close

**COMPARISON VALUE**

**Screen Name:** Comparison Value

**SAS Data Set:** N/A

**SAS Variable:** N/A

**Oracle Name:** *STEERDEFORMATION.COMPVALUE*

**Element Attributes:**

Oracle	SAS	
0		No steering rim deformation Record actual measured deformation to the nearest centimeters. Actual measured value in centimeters
-9999		Unknown

**Source:** Vehicle inspection.

**Remarks:**

Refer to the measurement diagram illustrated in **Rim/Spoke Deformation**.

The intent is to capture deformation caused by occupant contact rather than induced damage.

The center of the steering wheel hub is the reference plane for determining magnitude of deformation. A measurement is taken from this reference plane to that area of the rim which has the greatest deformation. This measurement should be referenced to an undisplaced area of the rim or compared to the rim of a similar undamaged vehicle.

**DAMAGE VALUE**

**Screen Name:** Damage Value

**SAS Data Set:** N/A

**SAS Variable:** N/A

**Oracle Name:** *STEERDEFORMATION.DAMAGEVALUE*

**Element Attributes:**

Oracle	SAS	
0		No steering rim deformation Record actual measured deformation to the nearest centimeters. Actual measured value in centimeters
-9999		Unknown

**Source:** Vehicle inspection.

**Remarks:**

Refer to the measurement diagram illustrated in **Rim/Spoke Deformation**.

The intent is to capture deformation caused by occupant contact rather than induced damage.

The center of the steering wheel hub is the reference plane for determining magnitude of deformation. A measurement is taken from this reference plane to that area of the rim which has the greatest deformation. This measurement should be referenced to an undisplaced area of the rim or compared to the rim of a similar undamaged vehicle.

**DEFORMATION**

**Screen Name:** Deformation

**SAS Data Set:** N/A

**SAS Variable:** N/A

**Oracle Name:** *STEERDEFORMATION.DEFORMATIONVALUE*

**Element Attributes:**

Oracle SAS

0 No steering rim deformation  
Record actual measured deformation to the nearest centimeters.  
Actual measured value in centimeters

**Source:** Vehicle inspection.

**Remarks:**

Refer to the measurement diagram illustrated in **Rim/Spoke Deformation**.

The intent is to capture deformation caused by occupant contact rather than induced damage.

The center of the steering wheel hub is the reference plane for determining magnitude of deformation. A measurement is taken from this reference plane to that area of the rim which has the greatest deformation. This measurement should be referenced to an undisplaced area of the rim or compared to the rim of a similar undamaged vehicle.

STEERING/DRAWING

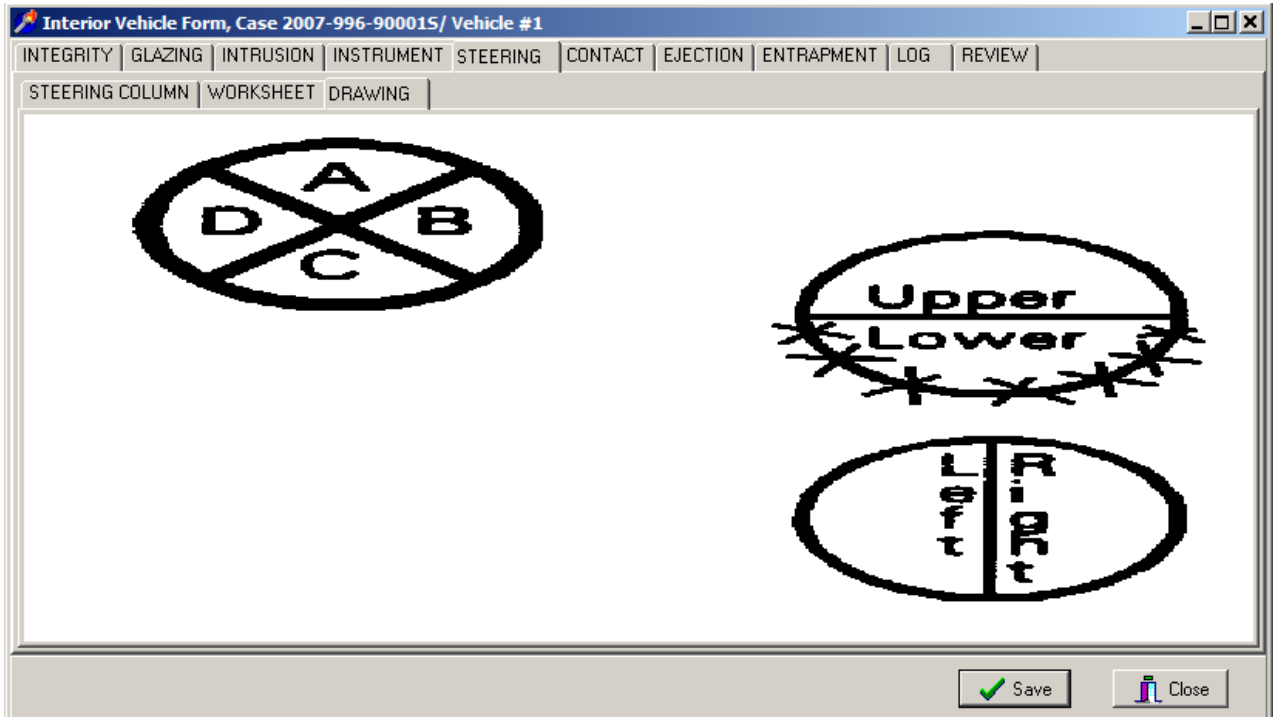

Instructions for completion of Steering Drawing Diagrams

The Steering Drawing Diagrams allows researchers to report data that are not encoded and might otherwise be omitted from the case. The intent is to capture deformation caused by occupant contact rather than induced damage.

The researcher should indicate on the drawings what portion of the rim/spoke was deformed. The drawings should reflect coded data in the Steering Column Tab/Location of Rim/Spoke Deformation.

CONTACT/LIST

Contact	Area	Component	Occ #	Body Region	Evidence	Confidence
---------	------	-----------	-------	-------------	----------	------------

CONTACT/CONTACT

Contact:

Area:

Component:

Evidence:

Confidence:

Occ #:

Body Region:

---

**Contact Overview**

Page 1 of 2

The Contact tab and corresponding Contact/Sketch sub-tabs provide a valuable link between vehicle interior documentation and occupant injury data. With the reduction of death and injury as the system-wide goal, occupant contacts to the vehicle are of critical concern. Identifying contact evidence helps relate the contacts to a body region of likely cause.

When identifying contact points, begin by assessing the occupant's likely trajectory during the crash sequence. Consider issues such as impact configuration, direction of force, and the use of restraint systems. It is important to have a systematic approach to locating and documenting occupant contact points. Examine the vehicle interior from left to right, top to bottom, or in any similar pattern that allows for a complete and consistent methodology.

**NOTE: It is important that contact identification be based on evidence.** PDOF, restraint use, air bag deployment, and other such factors are NOT contact evidence. These issues certainly have an effect on contacts and where they may occur; they are not, however, sufficient basis for coding a contact point.

Begin by locating all of the occupant contact points and highlighting them with the standardized metric contact tape. When all of the identifiable contacts are marked, click on the Contact sub-tab to enter data. On the title bar, select "Edit" and then select "Insert" from the drop-down menu. Enter the tab data as outlined below. The first contact point entered will be identified as contact "A"; each additional contact will be assigned the next letter in the alphabet. Remember, the "Edit/Insert" process must be repeated for each new contact point to be entered. The following variables will be coded for each contact point.

- Area – Select the general area of the vehicle where the contact occurred.
- Component – Select the specific component contacted.
- Evidence – Select the type of evidence identified on the vehicle component.
- Confidence – Select the confidence level that best represents the level of certainty that this is indeed a contact point; **this variable is based on contact certainty, not body region or occupant number certainty.**
- Occupant number – Select the case assigned number of the contacting occupant. If it can not be determined, assign the contact to the occupant who most likely caused it.
- Body Region – Select the body region of the occupant that is suspected to have caused the contact point. In complex events such as rollovers, this variable will be difficult to code. Select the body region most consistent with the dynamics involved. Do not downgrade the confidence level of the contact based on body region uncertainty.



With all contact points entered in the Contact sub-tab, open the Sketch#1 and Sketch#2 tabs to document the contact points. Both sketch sub-tabs will open a diagram that can be modified by double clicking to open the image editor. Cross hatch the contacted area and place the corresponding alphabet letter (assigned during the “Edit/Insert” process) next to the marked area. It is important to be sure that the alphabet character on the sketch matches the contact with the same assigned character. See IV 90-92 for more details. In addition to contacts, areas of ejection or entrapment should be annotated on these sketches.

**NOTE:** Some researchers may prefer to sketch all of the contact points first, then “Edit/Insert” each on the contact sub-tab. The order of completion is not the key; a methodical, consistent approach is important.

**CONTACT**

**Screen Name:** Contact

**SAS Data Set:** *CONTACT*

**SAS Variable:** *REFID*

**Oracle Name:** *OCCUPANTCONTACT.CONTACTREFERENCE*

**Element Attributes:**

- A
- B
- C
- D, etc.

**Source:** Vehicle inspection

**Remarks:**

Identify the contact point. This will correspond to the label used in Sketch 1 or Sketch 2. To add contact points go to the main menu and select “**Edit**” and then “**Insert**” and contact point “B” will appear.

**CONTACT AREA LABEL**

**Screen Name:** Area

**SAS Data Set:** *CONTACT*

**SAS Variable:** *CONTAREA*

**Oracle Name:** *OCCUPANTCONTACT.PICKCOMPONENTAREA*

**Element Attributes:**

Oracle	SAS	
1	1	Front
2	2	Left Side
3	3	Right Side
4	4	Interior
5	5	Air Bag
6	6	Roof
7	7	Floor
8	8	Rear
10		Left Door Panel
11		Right Door Panel
9	50	Adaptive (Assistive) Driving Equipment

**Source:** Vehicle inspection

**Remarks:**

Identify the name of the area of the vehicle interior an occupant contacted. Choose the area from the pick list of valid attributes for interior components.

**CONTACTED COMPONENT**

**Screen Name:** Component

**SAS Data Set:** *CONTACT*

**SAS Variable:** *CONTCOMP*

**Oracle Name:** *OCCUPANTCONTACT.PICKCOMPONENT*

**Element Values:**

**FRONT**

Oracle	SAS
1	1 Windshield
2	2 Mirror
3	3 Sunvisor
4	4 Steering wheel rim
5	5 Steering wheel hub/spoke
6	6 Steering wheel rim/hub/spoke
7	7 Steering column, transmission selector lever, other attachment
8	8 Cellular telephone or CB radio
9	9 Add on equipment ( <i>e.g.</i> , tape deck, air conditioner)
13	13 Glove compartment door
15	15 [Dr only] WS incl 1/+: fr hdr, A pill, instr pnl, mirror, or steering assembly
16	16 [Pass only] WS incl 1/+: fr hdr, A pill, instr pnl, or mirror
17	17 Windshield reinforced by exterior object (specify)
18	19 Other front object (specify):
100	20 Sunvisor reinforced by front header
101	21 Left instrument panel
102	22 Center instrument panel
103	23 Right instrument panel
104	24 Left lower instrument panel (includes knee bolster)
105	25 Center lower instrument panel (includes knee bolster)

106 26 Right lower instrument panel (includes knee bolster)

**LEFT SIDE**

Oracle	SAS
21	53 Left A (A1/A2)-pillar
22	54 Left B-pillar
23	55 Other left pillar (specify):
24	56 Left side window glass
25	57 Left side window frame
26	58 Left side window sill
27	59 Lt side glass +: frame, win sill, A pill, B pill, or roof side rail
28	60 Left side glass (Laminated) reinforced by exterior object (specify)
77	61 Other left side object (specify):
595	62 LeftSide panel forward A1/A2 pillar
596	63 Left Side panel rear of B-pillar

**LEFT DOOR PANEL**

576	576	Left forward upper quadrant
577	577	Left forward lower quadrant
578	578	Left rear upper quadrant
579	579	Left rear lower quadrant

Contacted Component (cont'd)

**Element Values: (cont'd)**

Oracle	SAS	588	588	Right armrest/hardware forward upper quadrant
580	580			
		589	589	Right armrest/hardware forward lower quadrant
581	581			
		590	590	Right armrest/hardware rear upper quadrant
582	582			
		591	591	Right armrest/hardware rear lower quadrant
583	583			

**RIGHT SIDE**

31	103	Right A (A1/A2)-pillar
32	104	Right B-pillar
33	105	Other right pillar (specify):
34	106	Right side window glass
35	107	Right side window frame
36	108	Right side window sill
37	109	Rt side glass +: frame, win sill, A pill, B pill, or roof side rail
38	110	Right side glass (Laminated) reinforced by exterior object (specify)
78	111	Other right side object (specify):
597	112	Right Side panel forward A1/A2 pillar
598	113	Right Side panel rear of B-pillar

**RIGHT DOOR PANEL**

584	584	Right door panel forward upper quadrant
585	585	Right door panel forward lower quadrant
586	586	Right door panel rear upper quadrant
587	587	Right door panel rear lower quadrant

**INTERIOR**

39	151	Seat, back support
40	152	Belt restraint webbing/buckle
41	153	Belt restraint B-pillar or door frame attachment point
42	154	Other restraint system component (specify):
43	155	Head restraint system
44	161	Interior loose object (specify)
46	162	Other interior object (specify):
47	163	Center console first row
164	164	Center console second row
165	165	Center console other row
166	166	Fold down armrest first row
167	167	Fold down armrest second row
168	168	Fold down armrest other row
592	592	Child safety seat shell
593	593	Child safety seat harness
594	594	Unknown child safety seat component
572	572	Seat LATCH points for child restraints
573	573	Grab handles
574	574	Engine shroud/cover
575	575	Seatback trays
576	576	Cargo in vehicle

**Element Values:** (cont'd)

**AIR BAG**

Oracle	SAS
48	170 Air bag-driver side
49	175 Air bag compartment cover-driver side
50	180 Air bag-passenger side
51	185 Air bag compartment cover-passenger side
52	190 Other air bag (specify)
53	195 Other air bag compartment cover (specify)

**ROOF**

54	201 Front header
55	202 Rear header
56	203 Roof left side rail
57	204 Roof right side rail
58	205 Roof or convertible top
206	206 Roof maplight/console
207	207 Sunroof/components
208	208 Roll bar

**FLOOR**

59	251 Floor (including toe pan)
60	252 Floor or console mounted transmission lever, including console
61	253 Parking brake handle
62	254 Foot controls including parking brake

**REAR**

Oracle	SAS
63	301 Backlight (rear window)
64	302 Backlight storage rack, door, etc.
65	303 Other rear object (specify):

**ADAPTIVE (ASSISTIVE) DRIVING EQUIPMENT**

66	401 Hand controls for braking /acceleration
67	402 Steering control devices (attached to OEM steering wheel)
68	403 Steering knob attached to steering wheel
69	404 Replacement steering wheel ( <i>i.e.</i> ,reduced diameter)
70	406 Joy stick steering controls
71	407 Wheelchair tie-downs
72	408 Modification to seat belts,(specify):
73	409 Additional or relocated switches,(specify):
74	410 Raised roof
75	411 Wall mounted head rest (used behind wheel chair)
76	412 Other adaptive device (specify):

**Source:** Vehicle inspection.

**Remarks:**

The researcher should record only those contact mechanisms which can be documented by some physical evidence (*e.g.*, scuffs, hair, smudges, dents, cracks, etc.).

\* **Note:** Whenever an "other" code is selected as injury source, clearly identify, in the space provided a description of the "other" source.

**Steering Rim/Hub/Spoke**

is selected when there is continuous or simultaneous contact by a single body region to the Steering Rim / Hub / Spoke. Additionally, use this attribute when the steering wheel is determined to be the suspected injury source, but it cannot be further determined if the rim / hub/ spoke are involved.

**[Dr only] WS incl 1/+: fr hdr, A pill, instr pnl, mirror, or steering assembly**

should be selected for contacts on the left (driver) side of the vehicle interior. This code applies only when there is a continuous or simultaneous contact to the windshield and one of the listed components by a single Body Region of the occupant.

**Note:** Some vehicles (*e.g.*, GM APV minivans) are designed with two upper A-pillars on each side. The forward most pillar is called an A1-pillar which is primarily designed to secure the windshield to the vehicle. The second pillar is labeled as an A2-pillar. This pillar generally lends support to the roof and also helps to establish the front door opening. Annotation should be provided on the Interior Vehicle Form specifying which pillar was most severely intruded.

**[Pass only] WS incl 1/+: fr hdr, A pill, instr pnl, or mirror**

should be selected for contacts on the right (passenger) side of the vehicle interior. This code applies only when there is a continuous or simultaneous contact to the windshield and one of the listed components by a single Body Region of the occupant.

**Windshield reinforced by exterior object**

is selected when, for example, an occupant contacts a windshield which has been reinforced by the hood of the occupant's vehicle.

**Lt (Rt) side glass +: frame, win sill, A pill, B pill, or roof side rail**

apply when there is a simultaneous or continuous contact by a single body region of an occupant to the appropriate side window glass and at least one of the listed components. The window sill consists, for this element, of the upper portion of the side interior surface immediately adjacent to the bottom of the side window opening.

**Right/Left side glass (Laminated) reinforced by exterior object (specify)**

should be selected when an occupant contacts the side glass which has been determined to be laminated and an exterior object (hood of a vehicle) was reinforcing the glass.

**Child safety seat**

Child restraint devices have caused confusion when they are the source of the injury. The child restraint (*i.e.*, infant/child seat, booster seat, etc.) is considered to be an integral restraint (*e.g.*, the whole seat is the restraint). When the restraint is used by an infant or child it should be coded as one unit. In the CDS the analyst is concerned with the complete seat and its performance.

Select this component if contact with a child safety seat occurs from either:

- a) an infant or child restrained by the child safety seat or
- b) any passenger including an infant or child who contacts a child safety seat but is not restrained by that seat.

When any body member of an infant or child, restrained by a child safety seat, contacts an interior object other than the child safety seat, then code the appropriate interior object (*i.e.*, Seat, back support; Head restraint system etc.)

**Instrument Panel**

The instrument panel is visually divided in half longitudinally by placing a line through the steering wheel column at a midpoint where the column enters the panel (see diagram below). The visual separation will serve as the vertical delineation between the "Left Instrument Panel" and the "Left Lower Instrument Panel (including knee bolster)" code. If it cannot be determined if a contact falls above or below this delineation or the contact falls on the delineation, default to the upper part or the "Left Instrument Panel" code.

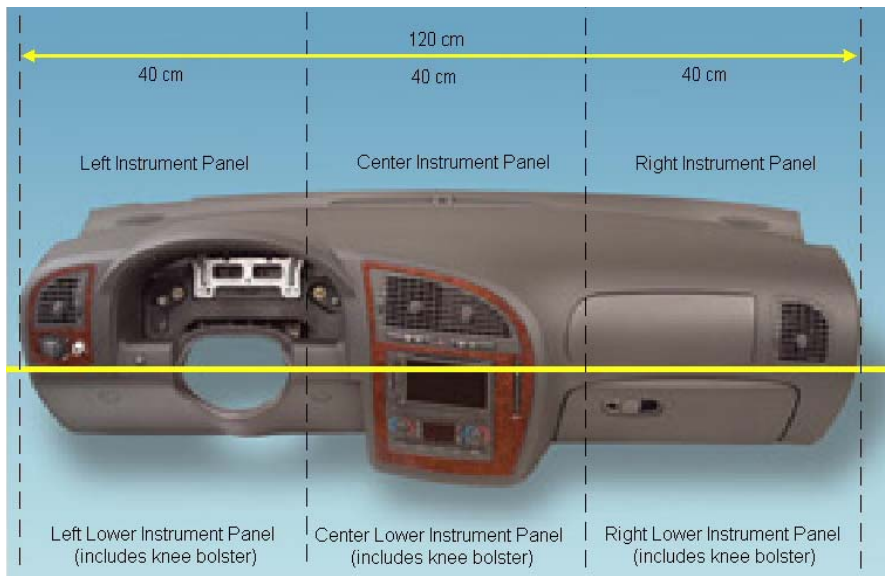



**Left /Right door panel quadrants**

The doors are visually divided into quadrants. The longitudinal measurement is taken at the beltline along the window frame. The vertical measurement is taken at the midpoint of the door, from the top edge to the bottom edge of the inner door panel.

The quadrants are rarely equal in size. They are named as follows: Forward Upper Quadrant (FUQ), Forward Lower Quadrant (FLQ), Rear Upper Quadrant (RUQ), and Rear Lower Quadrant (RLQ). Select the quadrant that best represents the contact.

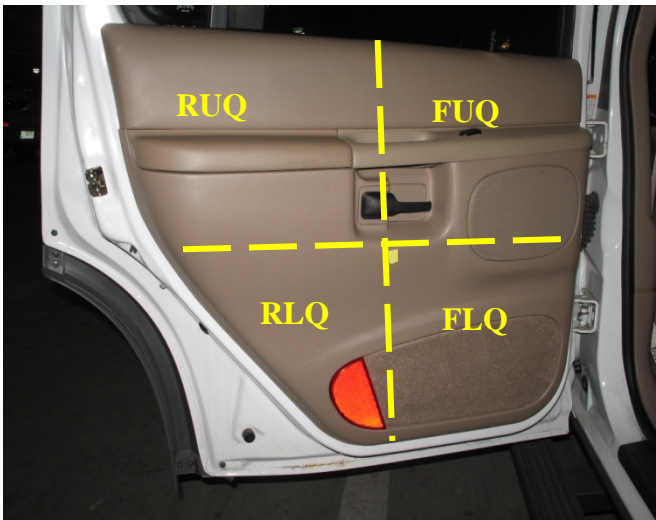

**Left/Right hardware/armrest quadrants**

The door panel is visually divided as described in Left/Right door panel quadrants. These attributes are selected if a portion of the armrest or hardware is located within a given quadrants and is contacted. Select the quadrant that best represents the contact.

**Air bag-driver side**

only includes the steering wheel hub and the lower IP/knee bolster air bags.

**Air bag-passenger side**

only includes the IP and lower IP/knee bolster air bags.

**Other air bag (specify)**

includes side air bags (i.e., curtains, seat back, door mounted and roof rail air bags, etc.)

**Air bag compartment cover**

is the flap(s) portion of a deployed air bag.

**OCCUPANT NUMBER**

**Screen Name:** Occupant Number

**SAS Data Set:** *CONTACT*

**SAS Variable:** *OCCNO*

**Oracle Name:** *OCCUPANTCONTACT.OCCUPANTID*

**Element Attributes:**

Select occupant number from drop down list

**Source:** Vehicle inspection

**Remarks:**

The Researcher should identify the number of the occupant who is suspected of contacting the identified component, if it can be determined.

An occupant number must be selected, there is no unknown.

**Note:** If an occupant list for this vehicle does not appear, they must be added into the case structure on the Case Form, Structure tab, Occupant sub-tab).

**BODY REGION**

**Screen Name:** Body Region

**SAS Data Set:** CONTACT

**SAS Variable:** CONTREGN

**Oracle Name:** OCCUPANTCONTACT.AISID

**Element Attributes:**

Oracle	SAS		Oracle	SAS	
170	10	Abdomen	80	140	Knee – Left
25	15	Ankle – Left	70	145	Knee – Right
20	20	Ankle – Right	85	150	Knee – Unknown
27	22	Ankle - Unknown	320	155	Lower Arm – Left
180	25	Back	310	160	Lower Arm – Right
130	30	Buttock – Both	325	165	Lower Arm – Unknown
120	35	Buttock – Left	60	170	Lower Leg – Left
110	40	Buttock – Right	50	175	Lower Leg – Right
135	45	Buttock – Unknown	65	180	Lower Leg – Unknown
210	50	Chest	220	185	Neck
300	55	Elbow – Left	260	190	Shoulder – Left
290	60	Elbow – Right	250	195	Shoulder – Right
305	65	Elbow – Unknown	265	200	Shoulder – Unknown
240	70	Face	100	205	Thigh – Left
200	75	Flank – Left	90	210	Thigh – Right
190	80	Flank – Right	105	215	Thigh – Unknown
205	82	Flank - Unknown	280	220	Upper Arm – Left
15	85	Foot – Left	270	225	Upper Arm – Right
10	90	Foot – Right	285	230	Upper Arm – Unknown
16	95	Foot – Unknown	340	250	Wrist – Left
160	100	Genitals	330	255	Wrist – Right
360	105	Hand – Left	345	260	Wrist – Unknown
350	110	Hand – Right	400	999	Unknown
365	115	Hand – Unknown			
230	120	Head			
150	125	Hip-Left			
140	130	Hip – Right			
155	135	Hip – Unknown			

Body Region (cont'd)

Page 2 of 2

**Source:** Vehicle inspection.

**Remarks:**

The Researcher should identify the **suspected** body region of the occupant that contacted the identified component, if it can be determined or presumed.

**EVIDENCE**

**Screen Name:** Evidence

**SAS Data Set:** *CONTACT*

**SAS Variable:** *CONTEVID*

**Oracle Name:** *OCCUPANTCONTACT.PICKEVIDENCE*

**Element Attributes:**

Oracle	SAS	
1	1	Bent
2	2	Cracked
3	3	Scuffed
4	4	Transfer (specify)
5	5	Deformed
6	6	Blood
7	7	Hair
8	8	Stretched
9	9	Scratched
10	10	Teeth marks
11	11	Imprint
12	12	Spider Web
14	96	Combination (specify)
13	98	Other (specify)

**Source:** Vehicle inspection

**Remarks:**

The Researcher should identify the types of contact evidence present (i.e., scuff, tissue transfer, tooth mark, etc.) that indicates an occupant contact. Evidence is described as a thing or things that are helpful in forming a conclusion or judgment.

This variable is only for the researcher to determine that evidence existed that showed this object was/could have been contacted by an occupant. Occupant kinematics or the PDOF should not be used to determine contacts.

**Bent**

is described as an object that has been altered from its original shape. It is forced to assume a different direction or shape from its original shape.

**Cracked**

is described as an object that is broken so that fissures appear on the surface.

**Scuffed**

is described as to scrape and roughen the surface of an object.

**Transfer (specify)**

is described as to move a substance from one surface to another. The researcher must specify the type of transfer. Examples are:

- Make up or lipstick transferred from the occupant onto the air bag.
- Clothing transferred onto an object from the occupant.

**Deformed**

is described as an object that has been distorted in form and is misshapen.

**Blood**

is described as a fluid consisting of human plasma, blood cells, and platelets. Blood in and by itself, is not a reliable indicator of a contact point.

**Hair**

is described as cylindrical, keratinized, often pigmented filaments characteristically growing from the epidermis of a human. Evidence of a contact point by hair normally consists of hair embedded into an object.

**Stretched**

is described a relieving of stiffness by a pulling or a straining motion of an object.

**Scratched**

is described as to make a series of thin shallow cuts on a surface.

**Teeth marks**

is described as small punctures, usually characterized by "u" shaped, to an object.

**Imprint**

is described as an impression of a surface created by pressure.

**Spider web**

is described as being produced by an object coming in contact with automobile glass, i.e., windshield. The object impact the glass and a series of cracks emit from the center of the initial contact point.

Evidence (cont'd)

Page 3 of 3

**Combination (specify)**

is used when the researcher determines that more than one type of evidence existed for this contact point. Examples are:

- Hair embedded into the windshield with a spider web
- A cracked instrument panel with a scuff mark

**Other (specify)**

use this attribute when the contact evidence is not listed in the given attributes.

**CONFIDENCE LEVEL OF OCCUPANT CONTACT**

**Screen Name:** Confidence

**SAS Data Set:** *CONTACT*

**SAS Variable:** *CONTCONF*

**Oracle Name:** *OCCUPANTCONTACT.PICKCONFIDENCELEVEL*

**Element Attributes:**

Oracle	SAS	
1	1	Certain
2	2	Probable
3	3	Possible
9	9	Unknown

**Source:** Vehicle inspection

**Remarks:**

This variable specifies the researcher’s level of confidence that the component was **contacted by an occupant**, based on physical evidence collected during the vehicle inspection.

**Certain**

is coded when, based on **visible** physical evidence, it has been established beyond doubt or question that the component was contacted by an occupant.

**Probable**

is coded when, in all likelihood, an occupant contacted the component, although the evidence is insufficient to be absolutely sure.

**Possible**

is coded when there is more evidence for than against, however there is room for doubt, due to the lack of substantiating physical evidence.

**Unknown**

it is unknown whether the component listed as a contact point was contacted by an occupant or some type of induced or post-crash damage.



CONTACT/SKETCH 1 AND SKETCH 2

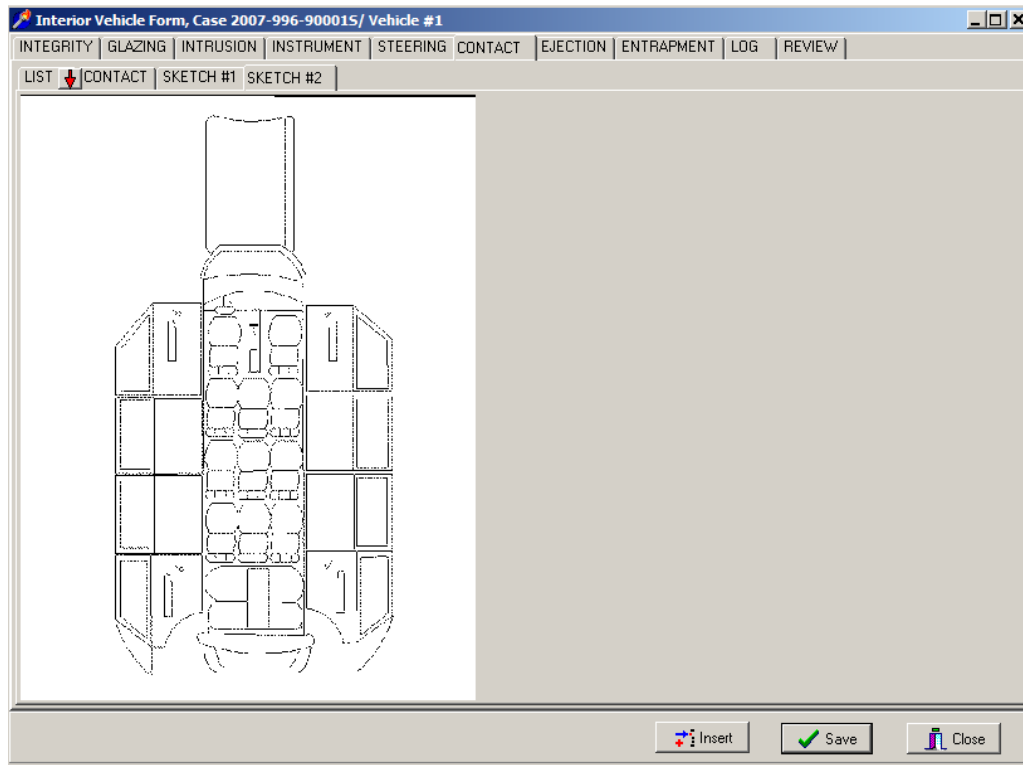
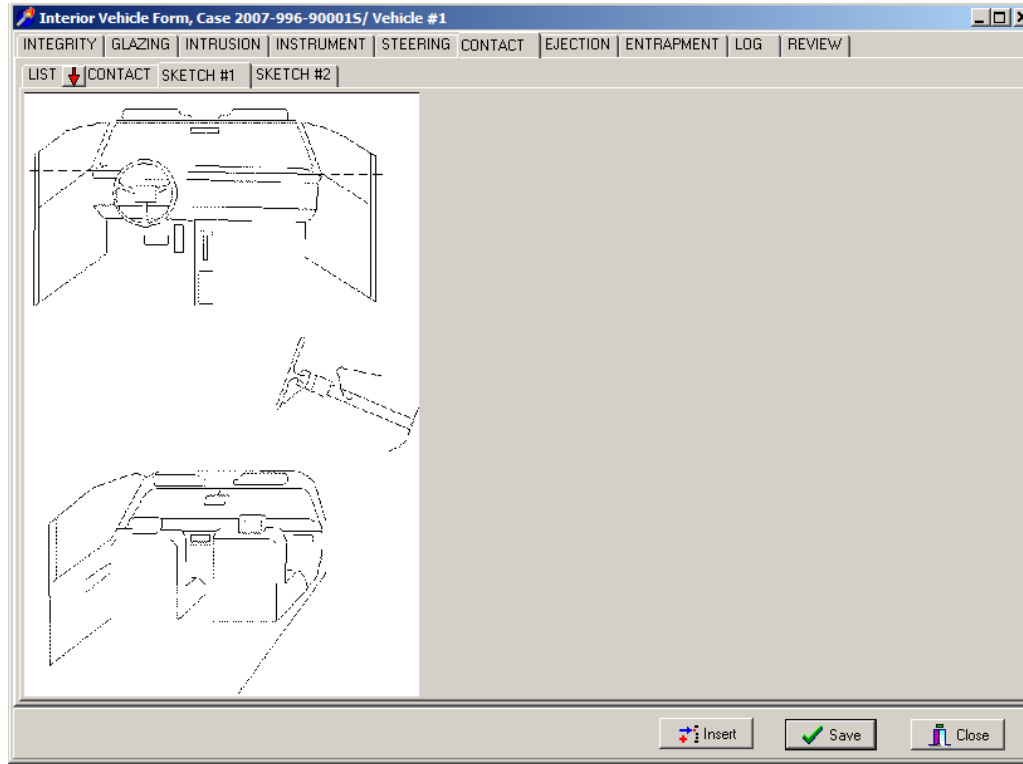

**Instructions for Completion of Vehicle Interior Sketches**

Open up Sketch 1 and Sketch 2 (by double clicking) the image.

Leave the Sketches open or minimized for ease in navigating between the Detail Tab, and the Sketches.

**For each documented Contact Point:**

Sketch the damaged area on Sketches 1 and 2 (e.g., windshield, instrument panel, glove compartment, front seat back, etc.).

Label the Contact point with a sequential alpha character beginning with the letter “A”.

Provide any annotations as necessary. X out or erase any seats that are not available in the seating geometry of the vehicle. X out or erase any side doors/panels that are not available in the vehicle.

Examples of a basic vehicle interior sketch is shown:

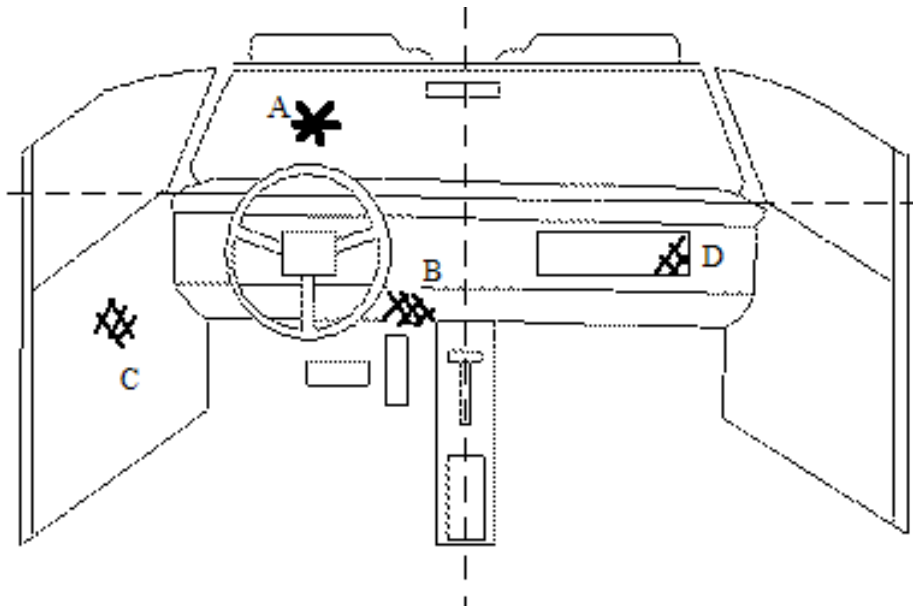

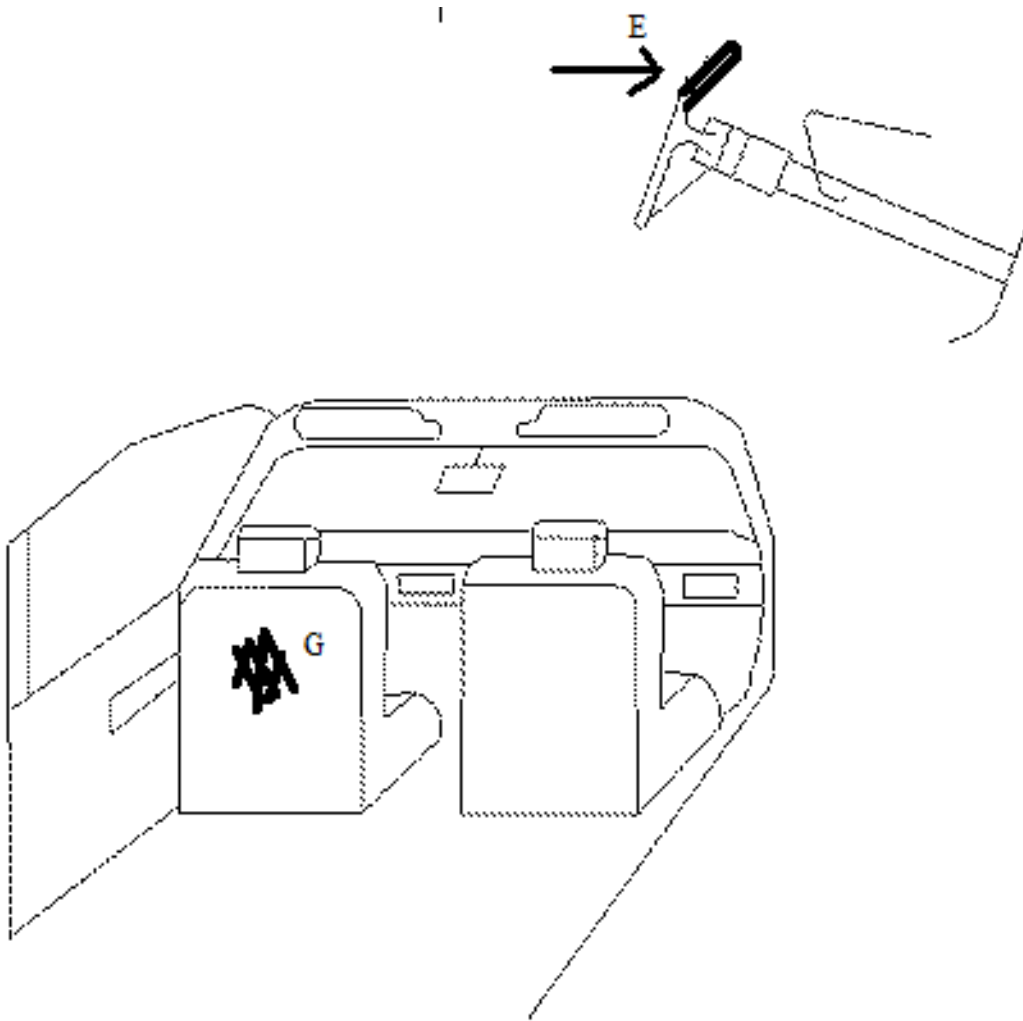

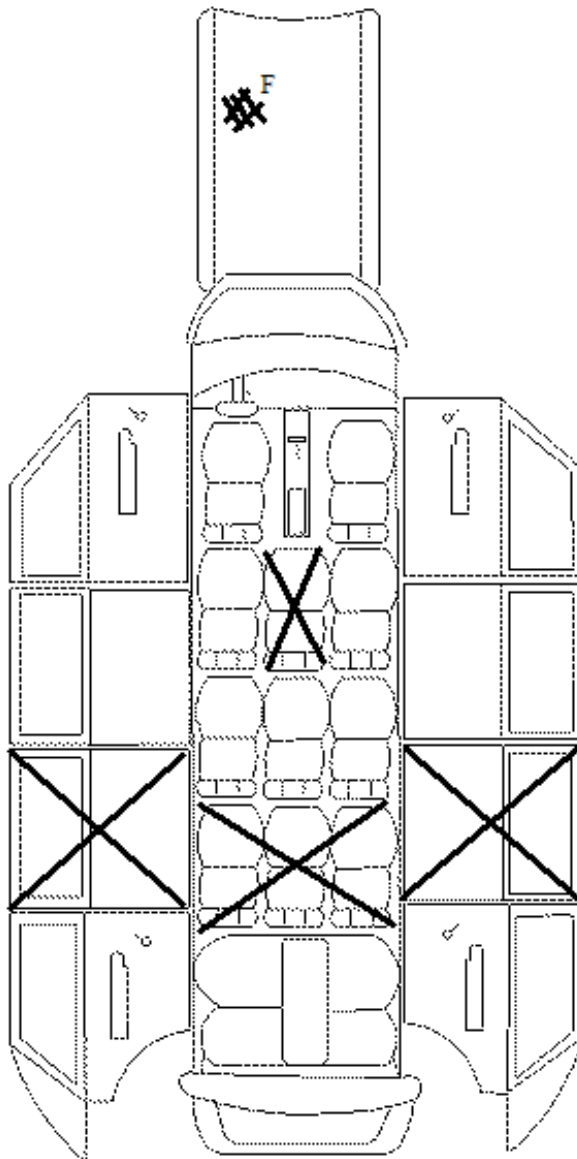

## **Ejection Overview**

Page 1 of 2

Variables in this section provide an assessment of the occurrence of ejection of an occupant. These variables in this section are coded based upon vehicle inspection. Verification of questionable ejections will come from the interview.

Historically, ejection from the vehicle has been a major cause of increased fatalities and serious injuries. The chances of being killed if ejected are about 1 in 5; whereas, if the occupant remains inside the vehicle, the chances of dying are reduced to about 1 in 200. Unfortunately ejection from the vehicle is not that uncommon and has become a significant part of the fatality and severe injury crashes. Further contributing to the ejection problem is the increase in window surface area and more hatchback models. Despite the current emphasis on restraint use through legal requirements for occupants to be seat belted, a significant portion of the population continues to be unrestrained and at risk to ejection.

A problem not often addressed is that of partial ejection. This refers to those instances where some part but not all of an occupant's body is, at some time during the crash sequence, outside the occupant compartment. Although it would not seem to be a problem it can be, and often is, fatal if the part outside is the occupant's head. Because of the dynamics of the vehicle and the kinematics of the occupants during an ejection sequence, it is often the occupant's own vehicle which causes the injury as it rolls onto the occupant.

Federal Motor Vehicle Safety Standards (FMVSS) which were developed in response to the problems seen in these areas are FMVSS 201 (Occupant Protection in Interior Impact), FMVSS 205 (Glazing Materials), FMVSS 206 (Door Locks and Door Retention Components), FMVSS 212 (Windshield Mounting), and FMVSS 216 (Roof Crush Resistance Passenger Cars).

Analytically this group of variables is a stand alone package most of the time. It can form the basis of an analysis without the use or comparison to any other variables. This would be used mostly in exploring the number and types of ejections. Expanding the scope somewhat to include injury severity allows a determination of the increase or decrease in the ejection problem. Inclusion of injury source would provide an idea of the severity of all occurrences of entrapment and ejection. Injury source also provides an idea of the kinematics of the occupant during the sequence. The addition of a cross-tabulation for AIS level would show the relative severity between the injuries incurred inside the vehicle and those outside the vehicle.

Other areas of interest to the analyst are the ejection route and performance of integral structures. The integral structure performance is directly governed by the FMVSS 206 and 212. These areas are of increasing interest to NHTSA since the real world

performance can help support the findings from the staged collisions and will help determine the effectiveness of the standards.

Gathering the data, which will allow the researcher to accurately select the variables, is a multistage process. It will begin with the PAR which may give an indication of ejection. Inspection of the vehicle will provide the evidence needed to substantiate the ejection. Further, documentation should be obtained through the scene inspection, interview, and injury data. Particular attention should be paid to the vehicle inspection since most evidence of ejection will be less apparent and not easily discerned.

In summary, this group of variables assesses the level of a very significant problem in today's crash picture. Correct accurate assessment is a result of a multistage research process, which will be individualized by case. Attention to detail will result in a correct assessment. This is an example which is directly tied to the FMVSS, and all gathered data results are a direct evaluation of the applicable standards.

EJECTION DETAIL/LIST

Ejection #	Occ #	Type	Area	Medium
------------	-------	------	------	--------

**Ejection/List**

All ejections that are documented on the preceding tabs will be displayed on this tab. This tab is generally used as an overview for all of the ejections. No fields can be edited here. To edit an ejection, return to the Detail tab and make any corrections.

DETAIL

Interior Vehicle Form, Case 2007-996-900015/ Vehicle #1

INTEGRITY | GLAZING | INTRUSION | INSTRUMENT | STEERING | CONTACT | EJECTION | ENTRAPMENT | LOG | REVIEW

LIST | **DETAIL**

Type

Area

Medium

Medium Status

Ejection #  of 0



**EJECTION NUMBER**

**Screen Name:** Ejection #

**SAS Data Set:** N/A

**SAS Variable:** N/A

**Oracle Name:** ***EJECTION.EJECTIONNUMBER***

**Element Value:**

Number as assigned

**Source:** Vehicle inspection

**Remarks:****Remarks:**

Each potential ejection is added by the researcher as it is located. The system will automatically increment the count. To add an ejection, go to the Title Bar and select “**Edit**” and then “**Insert**”.

**EJECTION - TYPE**

**Screen Name:** Ejection -Type

**SAS Data Set:** *OA*

**SAS Variable:** *EJECTION*

**Oracle Name:** *EJECTION.PICKEJECTIONTYPE*

**Element Value:**

Oracle	SAS	
1	0	No Ejection
2	1	Complete ejection
3	2	Partial ejection
4	3	Ejection, unknown degree
5	9	Unknown

**Source:** Vehicle inspection

**Remarks:**

Ejection refers to persons being completely or partially thrown from the vehicle as a result of an impact or rollover. If a person already has a body part protruding from the vehicle (e.g., an elbow, arm, etc.) and the PDOF acting on the vehicle would likely cause further protrusions of the body part, then at least partial ejection is selected.

**No Ejection**

is selected when there is no indication of any occupant being either partially or fully ejected from the vehicle.

**Complete ejection**

is selected when an the occupant’s body is entirely outside of the vehicle during the crash sequence. It is important to note that even though the body may be outside the vehicle, it may still be in contact with the vehicle. This code also includes occupants who are not initially in the passenger and contiguous cargo area of the vehicle (e.g., pickup beds, boot of a convertible, and persons riding on open tailgates).

**Partial ejection**

is selected when part of the occupant’s body remains **in** the vehicle, and any part of it is forced outside of the vehicle during the crash sequence. This code **does not apply** to those occupants who are not initially in the passenger and contiguous cargo area of the vehicle, they are indicated as “**Complete ejection**”.

**Ejection, unknown degree**

is selected when it is suspected (or known) that an ejection of the occupant occurred, however, at the time of the vehicle inspection the researcher was unable to determine if the ejection was **Partial** or **Complete**.

**Unknown**

is selected when:

- the vehicle has been completely repaired
- it cannot be determined if an ejection is applicable.

**EJECTION AREA**

**Screen Name:** Ejection—Area

**SAS Data Set:** N/A

**SAS Variable:** N/A

**Oracle Name:** ***EJECTION.PICKEJECTIONAREA***

**Element Attributes:**

Oracle	SAS	
11	0	[No ejection]
1	1	Windshield
2	2	Left front
3	3	Right front
4	4	Left rear
5	5	Right rear
6	6	Rear
7	7	Roof
9	9	[Unknown if ejected]
8	8	Other area
-9999	99	Unknown

**Source:** Vehicle inspection

**Remarks:**

**Rear**

is restricted to persons riding in a passenger compartment and contiguous cargo area, who are ejected through the rear window, tailgate (*e.g.*, station wagon), hatchback, etc.

**Roof**

applies to all hardtops, convertibles, sun roofs, t-bar roofs, and detachable hardtops (such as fiberglass tops) that are used to cover areas designed for passenger protection.

Examples follow for how the variables, Ejection Medium, and Medium Status (Immediately Prior to Impact), should be selected when **Area** equals **Roof**.

<b>Ejection</b>	<b>Roof Type</b>	<b>Area</b>	<b>Ejection Medium</b>	<b>Medium Status</b>
Ejection	Hardtop, ripped open during crash	Roof	Integral Structure	Integral Structure
Ejection	Removable hardtop, <u>attached</u> prior to crash	Roof	Integral Structure	Integral Structure
Ejection	Removable hardtop, <u>detached</u> prior to crash	Roof	Non-fixed roof structure	Open
Ejection	Convertible, in down or open position	Roof	Non-fixed roof structure	Open
Ejection	Convertible, in closed position	Roof	Non-fixed roof structure	Closed
Ejection	Sun or t-bar, closed, and ripped open during crash	Roof	Non-fixed roof structure	Closed
Ejection	Sun or t-bar, open/removed prior to crash	Roof	Non-fixed roof structure	Open

Ejection Attributes are designated for use with areas designed for passenger protection (e.g., passenger cars, vans, light truck cabs, self-contained mini- Recreational Vehicles and mini-motor homes). Trailers, add-on campers, etc., are to be assigned **Other area**.

**Other area**

also applies to persons riding on open tailgates.

**Unknown**

is selected when it is known from the vehicle inspection that an occupant was ejected (i.e., partial, full, or unknown degree) however, the area of potential ejection is unknown.

**EJECTION MEDIUM**

Page 1 of 2

**Screen Name:** Ejection—Medium

**SAS Data Set:** N/A

**SAS Variable:** N/A

**Oracle Name:** *EJECTION.PICKEJECTIONMEDIUM*

**Element Attributes:**

Oracle	SAS	
11	0	[No ejection]
1	1	Door/hatch/tailgate
2	2	Non-fixed roof structure
3	3	Fixed glazing
4	4	Non-fixed glazing (specify)
5	5	Integral structure
	79	[Unknown ejection area]
7	9	[Unknown if ejected]
6	8	Other medium (specify)
-9999	99	Unknown

**Source:** Vehicle inspection

**Remarks:**

**Door/hatch/tailgate**

includes any door, hatch, or tailgate that is opened during the course of the impact sequence.

**Non-fixed roof structure**

applies only to convertible, sun roofs, t-bar roofs, and removable hardtops when retracted/detached prior to the crash.

**Fixed glazing**

refer to any glazing in the vehicle that cannot be opened.

**Non-fixed glazing**

refer to any glazing in the vehicle that can be opened to any degree.

**Integral structure**

includes removable hardtops when attached to the vehicle prior to the crash. This also should be used when any vehicle structure, not designed to be opened (*e.g.*, standard roof), is torn open during the crash such as to permit ejection.

**Other medium (specify)**

applies to persons riding in pickup beds, on open tailgates, and for other situations which cannot be classified above. In addition, use this attribute when someone is ejected from a trailer, add-on camper, etc.

**Unknown**

is selected when the ejection medium it is not known.

**EJECTION MEDIUM STATUS**

**Screen Name:** Ejection—Medium Status

**SAS Data Set:** N/A

**SAS Variable:** N/A

**Oracle Name:** *EJECTION.PICKEJECTIONMEDIUMSTATUS*

**Element Attributes:**

Oracle	SAS	
11	0	[No ejection]
1	1	Open
2	2	Closed
3	3	Integral Structure
	79	[Unknown ejection area]
	89	[Unknown if ejected]
	99	Unknown

**Source:** Vehicle inspection

**Remarks:**

This variable is a description of the status of the area through which an occupant was ejected and is the status of the medium immediately prior to the impact.

**Open**

applies to convertible roofs, sunroofs, t-bar roofs, windows, doors or tailgates that are completely or partially open immediately prior to impact, or to other open areas of vehicles such as pickup beds, etc.

**Closed**

refers to a window that is completely closed when damaged, or to a convertible, sun, or t-bar roof that is closed when damaged. Sun and t-bar roofs are captured here if the ejection occurred through the designed opening in the sun or t-bar roof. However, if the roof was of a sun or t-bar type but the ejection occurred because a sizable opening was torn in the roof structure, then select **Integral structure**. This is also used for fixed glazings such as windshields and backlights which are in place prior to the collision. This also refers to a door that is closed, but when damaged, experiences latch and/or hinge failure causing the door to open.



**Integral structure**

should be used when any vehicle structure, not designed to be opened (*e.g.*, standard roof), is torn open during the crash such as to permit ejection.

**Unknown**

is used when the medium status prior to the impact is unknown.

### **Entrapment Overview**

Entrapment poses a different problem area. Recent years have brought about a vast improvement in the delivery of emergency medical attention to motor vehicle crash victims. This improvement has been achieved through the establishment of regional trauma centers, well equipped Mobile Intensive Care Units manned by trained paramedics even in rural areas, and a general increase in the knowledge of how to treat acute trauma. This improvement has not helped those victims who are restrained within the vehicle by deformed components. The improved care cannot be delivered because the personnel are unable to get to the victim, remove the victim from the vehicle, and deliver the victim to a treatment facility in a reasonable amount of time.

Entrapment is caused by the structure components of the vehicle entangling or intermingling with the occupants, preventing the occupants from exiting the vehicle. Manufacturers have designed crumple zones into vehicles to absorb energy. These structural parts are designed to crumple in a predetermined pattern to absorb the energy during a crash while maintaining the integrity of the passenger compartment. In so doing, the occupants of the vehicle can become entrapped by the structure of the vehicle deforming around them.

Enter any observations or indications of possible entrapment or mobility restrictions. Careful observations should be made of intruding vehicle components, i.e., jammed doors, crushed roof, or other mechanisms that might have restrained the occupants, restricted their mobility, or limited egress from the vehicle.

Extrication tool marks are an indication of entrapment. Although, the cutting off of the roof of a vehicle is not an indication of entrapment.

## ENTRAPMENT

The screenshot shows a software window titled "Interior Vehicle Form, Case 2007-996-900015/ Vehicle #1". The window has a menu bar with the following options: INTEGRITY, GLAZING, INTRUSION, INSTRUMENT, STEERING, CONTACT, EJECTION, ENTRAPMENT, LOG, and REVIEW. Below the menu bar is a "COMMENT" section. A button labeled "No Entrapment" is selected, and the main area below it is a large, empty white text box. At the bottom right of the window, there are two buttons: "Save" (with a green checkmark icon) and "Close" (with a red X icon).

Enter any observations or indications of possible entrapment or mobility restriction. Careful observation should be made of intruding vehicle components, jammed doors, crushed roof, or other mechanisms that might have restrained occupants or restricted or limited egress from the vehicle.

If no entrapment was indicated select the "No Entrapment" button and the note area is prefilled.

LOG

Interior Vehicle Form, Case 2007-996-900015/ Vehicle #1

INTEGRITY | GLAZING | INTRUSION | INSTRUMENT | STEERING | CONTACT | EJECTION | ENTRAPMENT | LOG | REVIEW

**Documentation of**

Integrity	<input type="text"/>	Steering Column/Wheel	<input type="text"/>
Glazing	<input type="text"/>	Occupant Contacts	<input type="text"/>
Intrusions	<input type="text"/>	Ejection /Entrapment	<input type="text"/>

**Quality of Interior Slides**

Subject	<input type="text"/>	Slides	<input type="text"/>
---------	----------------------	--------	----------------------

Save Close

**PSU REVIEW**

Interior Vehicle Form, Case 2007-996-900015/ Vehicle #1

INTEGRITY | GLAZING | INTRUSION | INSTRUMENT | STEERING | CONTACT | EJECTION | ENTRAPMENT | LOG | REVIEW

PSU REVIEW | ZONE REVIEW

LIST | DETAIL

Form  Tab  Veh#  Occ#

Original  Suggested

Comment

Save Close

ZONE REVIEW

Interior Vehicle Form, Case 2007-996-900015/ Vehicle #1

INTEGRITY | GLAZING | INTRUSION | INSTRUMENT | STEERING | CONTACT | EJECTION | ENTRAPMENT | LOG | REVIEW

PSU REVIEW | ZONE REVIEW

LIST | DETAIL

Form  Tab  Veh #  Occ #

Original  Final

Reason  Change

Comment

### Safety Systems Form Overview

The Safety System form captures information about all occupant protection systems in the vehicle. These systems include belt restraints, pretensioners, LATCH systems, air bags, child restraints and belt positioning devices. Record only information obtained during the vehicle inspection on the Safety Systems form. This form contains shared information on the Seat, Restraints, Air Bag, and Child Seat tabs with the Occupant form.

Researchers must determine the **usage and function level** of restraints **for every seating position in the vehicle, regardless of whether the seating position is occupied**. Evaluate belt usage for this crash only.

Consider the following evidence as indicating usage:

- **belts/fittings damaged by occupant loading:** deformed anchor components, stretched webbing, latch plate peening (loading impression on metal);
- **position of belts:** laying on seat cushion (cut or whole) or retracted into spool with no dust on the belt over the D-ring and the belt can be spooled out easily;
- **condition of belts:** slight fraying on belt edges close to latch plate position (older vehicles), no dust on belt at D-ring on pillar, cut for occupant extraction by emergency personnel (usually at an easily accessible position).

Consider the following evidence as evidence of non-usage:

- **Position of belts:** Shoulder portion behind seat back, lap portion tucked into the seat bight, belt locked into place in unused position.
- **Condition of belts:** dirty, dust covered, mechanically unusable (buckle or latchplate damaged, parts missing or otherwise not usable), size adjustment on fixed length belts inappropriate for occupant, cut for convenience or comfort (out of the way, near housings), tucked under seat cushions or into the seat bight.

The usage must be determined on this form using only the evidence in the vehicle at the time of inspection. Do not use inputs from any other sources in coding the Safety Systems screens. Final determination of belt restraint “usage in this crash” is coded on the Occupant Assessment form. Vehicle evidence along with police report information, interviews, relationship of contact points to seat position relative to the PDOF(s) assigned to the vehicle, presence of belt-caused occupant injuries, and presence or absence of ejection are considered before encoding restraint usage on the Occupant Assessment screens. In summary, agreement between the Safety Systems belt coding for usage and the coding in the Occupant form is not required.

Every air bag for every seating position, regardless of deployment, must be listed in the Air Bag tab and completely documented. Deployed air bags must be checked thoroughly to document possible damage to the bag or flaps. Determination of air bag function and injury causation depends on complete documentation of this data. Every air bag for every seating position must be listed in the Air Bag tab. If the bag is not deployed, presence can be more difficult to determine. Most frontal bags are clearly labeled. Some side and roof bags will also have labels. However, information on possible airbag presence should be obtained before inspection of the vehicle. This information should be obtained from the current MY (Model Year) Safety Equipment list, Zone Center, owner's manual or dealer body shop.

If a vehicle has air bags, it may also have pretensioners. Most recent model year vehicles have pretensioners for the outboard belt restraints in the first seat row and sometimes in the second seat row. These devices are attached to either the retractor or buckle stalk of lap/shoulder belts in seat positions with OEM air bags. The devices reduce slack in belt restraints just prior to air bag deployment. Removal of slack brings the occupant into the correct position for bag deployment. Many of the pretensioners cause the belt to remain in its at-crash position well after the crash. Thus, if the occupant was wearing the belt at deployment, the belt remains spooled out and locked in place. Conversely, if the occupant was unbelted, the belt can be locked in the stored position. Both of these occurrences confirm pretensioner presence. All buckle pretensioners must be measured if actuated.

Child restraints (integrated, booster, convertible or infant) must be inspected and completely documented. If the child restraint is in the vehicle at the time of inspection, photograph the restraint in its installed position, then remove and photograph the restraint according to the CDS Digital Photography Guidelines Manual. Complete all applicable coding at the time of inspection. Thoroughly document any damage to the restraint. Do not re-install the Child Safety Seat.

A Field Safety Notification (FSN) should be submitted when there is a suspected component malfunction that occurred during the crash sequence.



**SEAT**

Safety Systems Form, Case 2007-996-900015/ Vehicle #1

SEAT RESTRAINTS AIR BAG CHILD SEAT LOG REVIEW

SEAT DEFINITION FIRST ROW SECOND ROW THIRD ROW FOURTH ROW FIFTH ROW

< Right >

	No Seat	No Seat	No Seat	No Seat	
No Seat	No Seat	No Seat	No Seat	No Seat	No Cargo Area
No Seat	No Seat	No Seat	No Seat	No Seat	
No Seat	No Seat	No Seat	No Seat	No Seat	
No Seat	No Seat	No Seat	No Seat	No Seat	

< Front >

Save

Select the seating positions that are in the vehicle at the time of the inspection, all seating positions are indicated. If no seat is present, that seating position is still defined.

SEAT DEFINITION

Safety Systems Form, Case 2011-48-070F/ Vehicle #1

SEAT | RESTRAINTS | AIR BAG | CHILD RESTRAIN | LOG | REVIEW

SEAT DEFINITION | FIRST ROW | SECOND ROW | THIRD ROW | FOURTH ROW | FIFTH ROW

	Left	Center	Right
<b>Seat</b>			
Type	Bucket		Bucket
Orientation	Unknown		Forward facing seat
Track	Unknown		Seat at rear most track position
Performance	Unknown		Seat assembly intact
Integrated Restraints	No		Yes
<b>Head Restraint</b>			
Type	No head restraints		No head restraints
Damage	No head restraints		No head restraints
Active	None present		None present
Rollover Protection	<input type="checkbox"/>	<input checked="" type="checkbox"/>	<input type="checkbox"/>
<b>Seat Back</b>			
Prior	Unknown		Not Adjustable
Post	Unknown		Not Adjustable
<b>Airbag</b>			
Ever Available	Yes		Yes

Save Close

**OCCUPANT'S SEAT POSITION**

**Screen Name:**           Seat Location Identification

**SAS Data Set:**         ***OA***

**SAS Variable:**        ***SEATPOS***

**Oracle Name:**        ***SEATLOC.SEATROW and SEATLOC.SEATLOCATION***

**Front Row**

- 11 Left side
- 12 Middle
- 13 Right side
- 19-Unknown seat

**Second Row**

- 21 Left side
- 22 Middle
- 23 Right side
- 24 Far right side
- 29-Unknown seat

**Third Row**

- 31 Left side
- 32 Middle
- 33 Right side
- 34 Far right side
- 39-Unknown seat

**Fourth Row**

- 41 Left side
- 42 Middle
- 43 Right side
- 44 Far right side
- 49-Unknown seat

**Fifth Row**

- 51 Left side
- 52 Middle
- 53 Right side
- 54 Far right side
- 59-Unknown seat

**Cargo Area**

**Source:** Vehicle inspection

**Remarks:**

“Far right side” is only to be used if the seat has four seating positions.

More than one person may be assigned to a seating position. When this happens, the appropriate **Posture** must be selected to account for this.

The seating position by the steering wheel should be assigned to the assumed driver of a hit-and-run vehicle unless evidence indicates a different position for the person or persons.

If seating in the vehicle is longitudinal rather than lateral, use the basic idea of a vehicle interior being divided laterally into roughly equal thirds and visualize lateral rows of seats to determine what seat position is the best descriptor.

Persons appended to the vehicle in motion are not considered to be occupants of the vehicle.

**Unknown seat**

is used when the seating position for this occupant is unknown but the row is known. Unknown seat should be used only after exhausting all other means of determining seat position.

**SEAT TYPE**

**Screen Name:** Seat – Type

**SAS Data Set:** SEATLOC

**SAS Variable:** SEATTYPE

**Oracle Name:** SEATLOC.PICKSEATTYPE

**Element Attributes:**

Oracle	SAS	
2	1	Bucket
3	2	Bucket with folding back
4	3	Bench
5	4	Bench with separate back cushions
6	5	Bench with folding back(s)
7	6	Split bench with separate back cushions
8	7	Split bench with folding back(s)
9	8	Pedestal ( <i>i.e.</i> , column supported)
10	9	Box mounted seat ( <i>i.e.</i> , van type)
11	10	Other seat type (specify)
13	11	Stowed/Removed
12	99	Unknown Seat Type

**Source:** Vehicle inspection.

**Remarks:**

This variable assesses the type of seat present at each defined position. Because the type of seat may have an effect on occupant kinematics, the type of seat is important to analysts.

The term “folding back(s)” refers to seat backs that are designed to fold significantly forward of upright. These seats usually fold forward to allow easier access to the area behind the seat for egress, ingress and cargo. Seats that recline only rearward are not considered to be folding backs. Folding backs, because of the additional possibility of malfunction of the folding mechanism, take precedence over solid or separate back cushions. “Folding back(s)” is not selected if only the lower part of the seat back folds forward (for an armrest, console or trunk access). If a center seat back is separate from the outboard seat backs and folds forward for an armrest or console (in many light truck type vehicles), it is not coded as a folding back.

If a seat was folded down at the time of inspection, record the data as if the seat was in the upright position.

If a seat was removed or stowed prior to the crash, the seat position will be defined. But, no seat or safety restraint systems except air bag data will be coded for that position. A seat is considered stowed if the seat back and bottom move in the act of stowing.

The first row seats in two-door vehicles will usually have folding backs. The first row seats in four-door vehicles will usually not have folding backs.

**Bucket**

A bucket seat is a standalone seat intended for a single occupant, and shares no seatback hardware or cushion with any other seating position. Its bottom anchorage or track is attached directly to the vehicle floor, and is also not shared with any other seating position.

**Bucket with folding back**

A seat may be coded with this attribute if it meets the definition of a bucket seat and also has a seatback that folds forward.

**Bench**

A bench seat is intended for multiple occupants, has a single-piece cushion, and a single-piece seatback.

**Bench with separate back cushions**

Seats may be coded with this attribute if they have a bench type cushion, and have multiple unconnected seatbacks, and the seatbacks do not fold forward.

**Bench with folding back(s)**

Seats may be coded with this attribute if they have a bench type cushion and have single-piece or multiple-piece seatbacks which fold forward.

**Split bench**

A split bench is a bench seat, the cushion of which is divided into two or more unconnected pieces.

**Split bench with separate back cushions**

Seats may be coded with this attribute if they have a split-bench type cushion, and have multiple unconnected seatbacks, and the seatbacks do not fold forward.

**Split bench with folding back(s)**

Seats may be coded with this attribute if they have a split-bench type cushion, and have single-piece or multiple-piece seatbacks which fold forward.

**Box mounted seat (i.e. van type)**

Identifies elevated seats that are attached to a box that is fastened to the floor. The seat tracks are bolted to the top of the box. This type of seat is often found in the front row of vans.

**Pedestal (i.e. column supported)**

Pedestal seats are often found in vans and may have a swivel mechanism.

**Examples** of some seat types and the appropriate attributes:

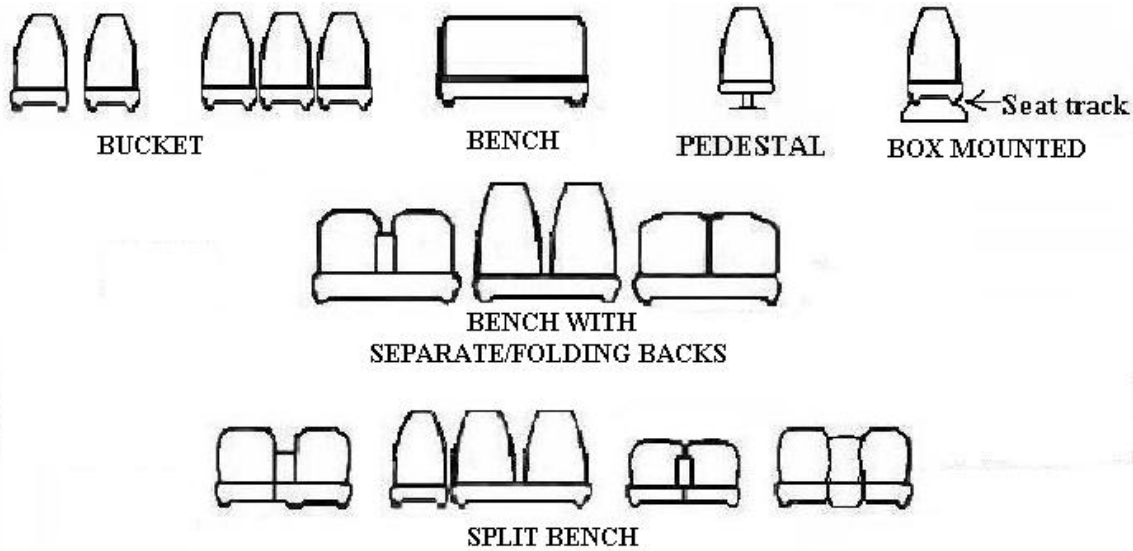

**Stowed/Removed**

A seat is considered stowed if the seat back and bottom both move during the act of stowing.

**Unknown**

Unknown will be coded if a seat was present for the crash but is unavailable for inspection.

BUCKET SEATS



BENCH SEATS



SPLIT BENCH SEATS





**SEAT ORIENTATION**

**Screen Name:** Seat – Orientation

**SAS Data Set:** SEATLOC

**SAS Variable:** STORIENT

**Oracle Name:** SEATLOC.PICKSEATORIENTATION

**Element Attributes:**

Oracle	SAS	
		[Not Applicable]
1	1	Forward facing seat
2	2	Rear facing seat
3	3	Side facing seat (inward)
4	4	Side facing seat (outward)
5	8	Other (specify):
6	9	Unknown Orientation

**Source:** Vehicle inspection.

**Remarks:**

Most seats are fixed in terms of their orientation within the vehicle; however, some seats (*e.g.*, swivel or reversible) can be oriented in more than one direction. Swivel seats and reversible seats (*e.g.*, some station-wagons or vans) are entered according to their orientation at the time of impact [*i.e.*, **Forward facing seat** or **Rear facing seat**].

**Forward facing seat**

is used when the seat is oriented towards the front plane of the vehicle.

**Rear facing seat**

is used when the seat is oriented towards the rear plane of the vehicle.

**Side facing seat (inward)**

is used when the seat is oriented towards either the right or left planes of the vehicle and faces inward.

**Side facing seat (outward)**

is used when the seat is oriented towards either the right or left planes of the vehicle and faces outward.

**Other**

is used when a seat is oriented such that the above attributes do not apply.

**Unknown**

is used when the seat orientation cannot be determined.

**SEAT TRACK POSITION**

**Screen Name:** Seat—Track

**SAS Data Set:** SEATLOC

**SAS Variable:** SEATRACK

**Oracle Name:** SEATLOC.PICKTRACKPOSITION

**Element Attributes:**

Oracle SAS

		[Not Applicable]
1	1	Non-adjustable seat track
2	2	Seat at forward most track position
3	3	Seat between forward most and middle track positions
4	4	Seat at middle track position
5	5	Seat between middle and rear most track position
6	6	Seat at rear most track position
7	9	Unknown Seat Track Position

**Source:** Vehicle inspection.

**Remarks:**

The researcher should attempt to determine the seat position at impact. When the researcher begins the interior inspection, he/she should note the position of the seat. The researcher should then move the seat forward and back along its track and determine the number of positions. Once this has been done, the seat should be moved to the position initially observed and photographed.

If the seat has electric adjusters with no distinct track positions, attempt to determine the relative position of the seat and select accordingly.

**Non-adjustable seat track**

Use this for seats that cannot be moved longitudinally.

**Adjustable Seat Track**

**Seat at forward most track position**

Use this if the seat is at the forward limit of the track.

**Seat between forward most and middle track position**

Use this if the seat is at any position between the most forward and middle seat positions.

**Seat at middle track position**

Use this if the seat is in the position mid-range between the forward and rear most track position.

**Seat between middle and rear most track position**

Use this if the seat is at any position between the middle and rearmost track position.

**Seat at rear most track position**

Use this attribute if the seat is at the rear limit of the track.

**Unknown**

Use this attribute if the seat position at impact cannot be determined.

**SEAT PERFORMANCE**

**Screen Name:** Seat—Performance

**SAS Data Set:** *SEATLOC*

**SAS Variable:** *SEATPERF*

**Oracle Name:** *SEATLOC.PICKSEATPERFORMANCE*

**Element Attributes:**

Oracle SAS

		[Not Applicable]
1	1	Seat assembly intact
2	2	Seat adjuster mechanism separated/deformed
3	3	Seat back folding locks or seat back structure separation (specify)
4	4	Seat tracks/anchors separated/deformed
5	5	Deformed by occupant of this seat
6	6	Deformed by passenger compartment intrusion (specify)
10	10	Deformed by Cargo
11	11	Deformed by Other Occupant
7	7	Combination of above (specify)
88	98	Other (specify)
99	99	Unknown

**Source:** Vehicle inspection.

**Remarks:**

This variable assesses the performance of the seat. The attributes are indications of whether the seat malfunctioned or was deformed in any way. Select the attribute which corresponds to the appropriate seat performance malfunction or deformation. Minor smudges, scrapes, dents, etc. are not considered deformation. If a malfunction or deformity occurs, then document the malfunction or deformation with a diagram and explanation. In addition, include photographs of the seat malfunction or deformity.

**Seat assembly intact**

is used if the seat was not deformed or no portion of the seat structure separated during the crash.

**Seat adjuster mechanism separated/deformed**

is used if any of the mechanisms used to adjust a seat's "comfort" position are separated or deformed during the crash as a result of occupant loading.

**Seat adjuster mechanisms include:**

- Height adjustment
- Longitudinal (horizontal) seat track adjustment
- Rocker adjustment
- Swivel/rotational adjustment
- Seat back recliner adjustment

For a seat back recliner separation, the seat back must have released in a rearward direction. Do not use this attribute if the seat back moved in a forward direction and the seat has a folding lock mechanism (*e.g.*, front seats in 2-door vehicles); see **Seat back folding locks or seat back structure separation** below. This should be used when multiple adjuster separations have been detected. Be sure to include supportive written and photographic documentation to support all separations/deformities.

**Seat back folding locks or seat back structure separation (specify):**

is used when the mechanism which is designed to lock the seat back in its upright position deforms or separates allowing the seat back to move forward during the collision as a result of occupant loading. "Seat back" separation refers to forward facing seats where seat back structural deformities (*e.g.*, seat back hinge points) resulted in a separation of the seat back from its anchorage points. Again, to be considered applicable for this, the seat must have separated/deformed while moving forward during the collision as a result of occupant loading.

**Seat tracks/anchors separated/deformed**

is used if the seat separates, to any degree, from a seat track during the crash. In addition, use this if the seat anchor that attaches the seat track to the floorpan separates, to any degree, during the crash. Box mounted seats are included in this if a separation occurred between the box and the floor or the box and the seat track/anchor. Seat track or anchor separations/deformities must be a result of occupant loading.

**Deformed by occupant of this seat**

is used when the seat is changed in form from its original design from occupant loading during the crash. Situations where seats are deformed and also experience mechanical separations should be identified under **Combination of above**.

**Deformed by passenger compartment intrusion**

is used when the seat is deformed or separated by intrusion of an interior vehicle component(s) or exterior vehicle component(s) into the passenger compartment.

**Deformed by Cargo**

is used when the seat is changed in form from its original design by impact from cargo during the crash. Examples of cargo: spare tire, luggage, construction equipment, tool(s), and tool box(es).

**Deformed by Other Occupant**

is used when the seat is changed in form from its original design by an occupant other than the occupant in this position, during the crash. Situations where seats are deformed and also experience mechanical separations should be identified under **Combination of Above**.

**Combination of above (specify)**

is used when any combination of the above occurs and describes multiple seat malfunctions or deformations. Seat malfunctions or deformations which are not described in the above are reported below. Seat malfunctions or deformations listed in the above take priority over others.

**Other**

is used when the only seat malfunctions(s) or deformation(s) which occur are not described in the above (*e.g.*, impact forces). If a seat doesn't have a comfort recline and is broken rearward code here.

**Unknown**

is used if the seat performance cannot be determined.

**DOES THE SEAT HAVE INTEGRATED PASSENGER BELTS?**

**Screen Name:** Seat—Integrated Restraints

**SAS Data Set:** SEATLOC

**SAS Variable:** INTGREST

**Oracle Name:** SEATLOC.INTEGRATEDRESTRAINTS

**Element Attributes:**

Oracle	SAS	
		[Not Applicable]
1	0	No
2	1	Yes
3	99	Unknown if integrated

**Source:** Vehicle inspection

**Remarks:**

An integrated seat belt is incorporated into the passenger seat. It is a three point seat belt system that includes a belt having one end affixed to the seat and an opposite end mounted to a retractor secured to the seat. A seat belt latch is mounted to the belt which has a releasable and lockable buckle on the opposite side of the seat. This allows the belt to pull across the passenger lap and the other portion of the belt to cross the upper torso. The belt extends through a guide located at the top of the seat. An integrated seat belt has no pillar attachment point.

If you were to remove the seat and the restraint comes with the seat indicate “Yes”.



**HEAD RESTRAINT TYPE AT THIS OCCUPANT POSITION**

**Screen Name:** Head Restraint -Type

**SAS Data Set:** SEATLOC

**SAS Variable:** HEADTYPE

**Oracle Name:** HEADRESTRAINT.PICKHEADRESTRAINTTYPE

**Element Attributes:**

Oracle	SAS	
		[Not Applicable]
1	1	No head restraints
2	2	Integral
4	3	Adjustable
6	4	Add-on
8	8	Other (specify)
9	9	Unknown

**Source:** Vehicle inspection.

**Remarks:**

FMVSS 202 (Head Restraints) only applies to 1<sup>st</sup> row seating positions. Although, the presence or non-presence of head restraints are captured for all seating positions in the vehicle. Some examples of head restraint styles are shown below.

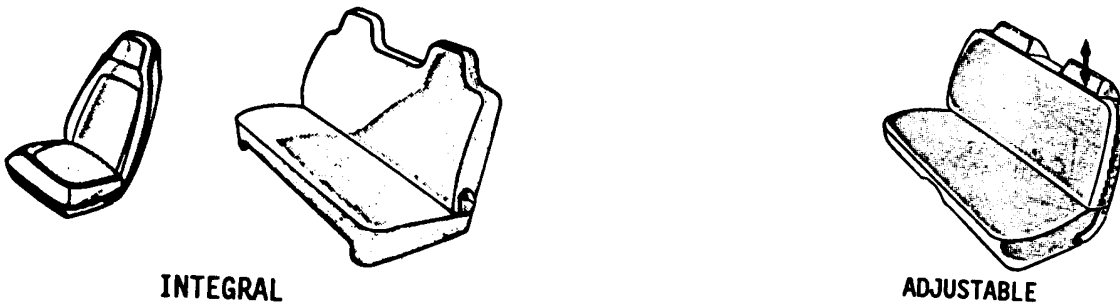

**No head restraints**

is used when (1) no head restraint is available for this seating position, or (2) there had been a head restraint but it had been removed prior to the crash.



**Integral**

refers to head restraints which are a continuous part of the seat back structure or those which are a separate structure but are not vertically adjustable. For rear seats only, if an obvious rise or sculpted head restraint is not observed, code as No Head Restraint.

**Adjustable**

applies to:

- head restraints which can be moved vertically to accommodate occupants of varying heights, and
- head restraints which have a fixed outer framework and a separate center section which is adjustable vertically.

**Add-on**

refers to clamp-on, strap-on, or even bolt-on head restraints on a vehicle not originally equipped with head restraints. This attribute should be infrequently used.

**Unknown**

is used when the type of head restraint cannot be determined

**Note:** Manufacturers are providing head restraints for rear seat occupants. These head restraints may be the same or similar to those used in the front seats, or they may be a slight rise in the rear seat back.

**HEAD RESTRAINT DAMAGE BY OCCUPANT AT THIS OCCUPANT POSITION**

**Screen Name:** Head Restraint – Damage

**SAS Data Set:** SEATLOC

**SAS Variable:** HEADDAMG

**Oracle Name:** HEADRESTRAINT.PICKHEADRESTRAINTDAMAGE

**Element Attributes:**

Oracle	SAS	
		[Not Applicable]
8	1	[No Head Restraints]
1	2	No damage
2	3	Damaged during crash
3	9	Unknown

**Source:** Vehicle inspection.

**Remarks:**

**No damage**

There was no damage to the head restraint by the occupant.

**Damaged during crash**

Any damage to a head restraint caused by the occupant in the seat position having the head restraint should be identified.

**Unknown**

is used when it is unknown if damage to the restraint was caused by an occupant in the appropriate seat position.

**Note:** Manufacturers are providing head restraints for rear seat occupants. These head restraints may be the same or similar to those used in the front seats, or they may be a slight rise in the rear seat back. **Any damage to a rear seat head restraint by the occupant in the seat position must be captured regardless of the height of the restraint.**

**ACTIVE HEAD RESTRAINT**

**Screen Name:** Head Restraint - Active

**SAS Data Set:** *SEATLOC*

**SAS Variable:** *HEADACT*

**Oracle Name:** *HEADRESTRAINT.ACTIVEHEADRESTRAINTID*

**Element Attributes:**

Oracle	SAS	
		[Not Applicable]
0	1	None Present
2	2	Present
3	9	Unknown

**Source:** Vehicle Inspection, interview

**Remarks:**

There should be a label on the seat indicating the presence of the active head restraint.

**ROLLOVER PROTECTION**

**Screen Name:** Rollover Protection

**SAS Data Set:** *OA*

**SAS Variable:** *ROLLPROT*

**Oracle Name:** *SEATLOC.ROLLOVERPROTECTION*

**Element Attributes:**

Check Box

Oracle	SAS	
0	0	No/Unknown (unchecked)
1	1	Yes (checked)

**Range:**

**Source:** Vehicle inspection, researcher determined

**Remarks:**

The purpose of this variable is to determine if the vehicle's rollover protection system was actuated.

Different types of systems are being used by manufacturers, also different names are used (i.e., Rollover Protection Systems (ROPS) or (RPS)). In the event of a crash that induces a certain amount of inclination roll-over sensors activate roll-bars that are integrated in or behind the seats, ensuring there is sufficient clearance for occupant's heads in the event of a crash. Also, an independent module behind each of the two rear-seat passengers' heads could deploy. A rollover need not occur for the rollover protection system to actuate.

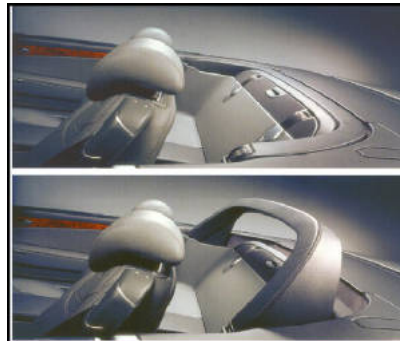

**SEAT BACK INCLINE PRIOR TO IMPACT**

**Screen Name:** Seat Back -- Prior

**SAS Data Set:** SEATLOC

**SAS Variable:** STPRINCL

**Oracle Name:** SEATLOC.PICKPRIORINCLINE

**Element Values:**

Oracle	SAS	
		[Not Applicable]
1	1	Not Adjustable
2	2	Upright
3	3	Slightly Reclined
4	4	Completely Reclined
9	9	Unknown

**Source:** Vehicle inspection

**Remarks:**

**This variable is for adjustable (reclining) seat backs only**

**Not adjustable**

is used for seating positions where there is a seat back which is fixed in position.

**Upright**

is used when the seatback is in the fully upright position (i.e., perpendicular to the seat cushion)

**Slightly reclined**

is used when the seat back is in a slightly reclined position

**Completely reclined**

is used when the seat back is in a position that is rearward to the limit of its range of movement.

**Unknown**

is used when the pre-impact position could not be ascertained. Includes if the seatback is folded down.

**SEAT BACK INCLINE POSITION POST IMPACT****Screen Name:** Seat Back -- Post**SAS Data Set:** SEATLOC**SAS Variable:** STPSINCL**Oracle Name:** SEATLOC.PICKPOSTINCLINE**Element Attributes:**

Oracle	SAS	
		[Not Applicable]
	01	[Not adjustable]
1,8	11,21	Moved to completely rearward position
2,9,16	12,22,32	Moved to rearward midrange position
3,17	13,33	Moved to slightly rearward position
4,10,15	14,23,31	Retained pre-impact position
11,18	24,34	Moved to upright position
5,12,19	15,25,35	Moved to slightly forward position
6,20,13	16,36,26	Moved to forward midrange position
7,14,21	17,27,37	Move to complete forward position
22	99	Unknown

\*Values depended upon the coding of Seat Back Prior.

**Source:** Vehicle inspection**Remarks:**

This variable is for adjustable (reclining) seat backs only. Select the attribute that describes the backrest position post-impact as determined from the vehicle inspection. The final coding of this variable on the Occupant form will take into account information gathered from the occupant interviews.

**Unknown**

is used when the post crash seat back position could not be determined.

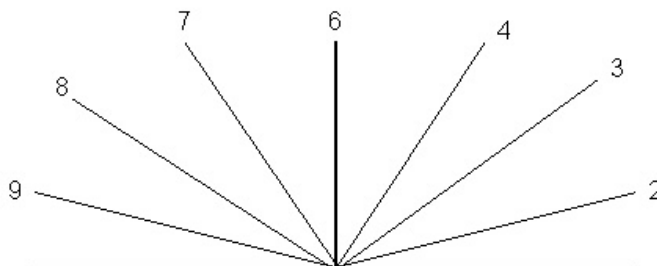

**AIR BAG EVER AVAILABLE**

**Screen Name:** Air Bag Ever Available

**SAS Data Set:** *SEATLOC*

**SAS Variable:** *BAGEVER*

**Oracle Name:** *SEATLOC.AIRBAGAVAIL*

**Element Attributes:**

Oracle	SAS	
1	0	No
2	1	Yes
3	99	Unknown

**Source:** Vehicle inspection

**Remarks:**

Code if this seating position has ever had an air bag available.

**RESTRAINTS/MANUAL/BELT**

Safety Systems Form, Case 2010-8701-030A/ Vehicle #1

SEAT | RESTRAINTS | AIR BAG | CHILD SEAT | LOG | REVIEW

MANUAL

FIRST ROW | SECOND ROW | THIRD ROW | FOURTH ROW | FIFTH ROW

BELT | COMPONENTS

	Left	Center	Right
Availability	<input type="text"/>	<input type="text"/>	<input type="text"/>
Used in this crash?	<input type="text"/>	<input type="text"/>	<input type="text"/>
Malfunction	<input type="text"/>	<input type="text"/>	<input type="text"/>
Anchorage Adjustment	<input type="text"/>	<input type="text"/>	<input type="text"/>

Save Close



## MANUAL (ACTIVE) BELT SYSTEM AVAILABILITY

Page 1 of 2

Screen Name: Availability

SAS Data Set: SEATLOC

SAS Variable: ACTAVAIL

Oracle Name: MANUALEATBELT.PICKMANUALBELTAVAIL

**Element Attributes:**

Oracle	SAS	
1	0	None available
2	1	Belt removed/destroyed
3	2	Shoulder belt
4	3	Lap belt
5	4	Lap and shoulder belt
6	5	Belt available - type unknown
7	6	Shoulder belt (lap belt destroyed/removed)
8	7	Lap belt (shoulder belt destroyed/removed)
9	8	Other belt (specify)
10	9	Unknown if available

Source: Vehicle inspection

**Remarks:**

Some belt restraint systems are a combination of manual (active) and automatic (passive) occupant protection devices. For this variable, consider only the manual portion of the system.

Availability is assessed based on the seat position regardless of whether it is occupied. Select the manual belt system which was available for use, if so desired, by the occupant relative to the seat position in the vehicle.

**Not available**

indicates: (1) that at the time of the crash the designated seating position was not equipped with a manufacture installed or post manufacturer installed manual belt (lap, shoulder, or lap and shoulder); (2) the seat position was equipped only with an automatic (passive) belt system.

**Belt removed/destroyed**

indicates that the manual belt, initially installed at this occupant's seating position, was subsequently removed or destroyed (*e.g.*, unbolted, cutout, etc.). If the belt is present but nonfunctional, then select the type of manual belt available on this variable and use **Inoperative** for **Used In This Crash?** Belts which are knotted, buckled at the rear of the seat (bench or bucket), stored below the seat, etc., are available if they were otherwise operative.

**Shoulder belt**

is used when this occupant's seat position was equipped with a manual upper torso restraint and no lap belt. The population of vehicles equipped with only manual shoulder belts is very small, therefore, care must be taken that a two-point passive belt is not identified as a manual belt (*e.g.*, Volkswagen Rabbits 1981-1984).

**Lap belt**

is used when this occupant's seat position is equipped with a manual belt that secures the pelvic area of the occupant in the seat and there is no manual upper torso belt.

**Lap and shoulder belt**

is used when both a manual upper torso belt and a manual lap (pelvic area) belt are present at this occupant's seat position.

**Belt available — type unknown**

When the specific manual belt system cannot be determined, but it is known some type of belt is present, then use this attribute (this **may** occur when inspecting completely burned or stripped vehicles).

**Shoulder belt (lap belt destroyed/removed)**

is used for integral noncontinuous loop manual belt systems when the lap belt portion of the belt has been removed or destroyed leaving only the shoulder belt portion present at this occupant's seating position.

**Lap belt (shoulder belt destroyed/removed)**

is used for integral noncontinuous loop manual belt systems when the shoulder belt portion of the belt has been removed or destroyed leaving only the lap belt portion present at this occupant's seating position.

**Other belt (specify)**

is used when the belt system is nonstandard or cannot be described with other attributes. Specify (write out in the Specify Box) the type of manual belt (*e.g.*, 5 point competition harness, 4 inch wide webbing, etc.). In addition, use this attribute if a properly positioned "self-contained" built-in child safety seat was available at this occupant's seating position. Other child restraints are not recorded here.

**Unknown**

is used when it cannot be determined whether or not manual belts were available for this occupant's seat position.

**MANUAL (ACTIVE) BELT SYSTEM USED IN THIS CRASH?**

Page 1 of 2

**Screen Name:** Used in this crash?**SAS Data Set:** SEATLOC**SAS Variable:** ACTUSE**Oracle Name:** MANUALESEATBELT.PICKMANBELTTYPE**Element Attributes:**

Oracle	SAS	
0	0	None used not available/removed or destroyed
1	1	Inoperative (specify)
2	2	Shoulder belt
3	3	Lap belt
4	4	Lap and shoulder belt
5	5	Belt used — type unknown
6	8	Other belt used (specify)
7	12	Shoulder belt with child safety seat
8	13	Lap belt with child safety seat
9	14	Lap and shoulder belt with child safety seat
10	15	Belt with child safety seat — type unknown
11	18	Other belt with child safety seat (specify)
12	99	Unknown if belt used

**Source:** Vehicle Inspection**Remarks:**

Select the manual belt system or portion of the system which was in use at the time of the crash by the occupant. The correctness of the use is not assessed on this variable. This variable only identifies manual belt usage; do not consider the presence and use of a passive belt system.

**None used/not available/removed or destroyed**

is used when a manual belt was available but not worn at the time of the crash. **Note:** the “**not available/removed or destroyed**” within this selection is automatically selected when the corresponding attribute is selected in **Manual Belt Availability**.

**Inoperative**

includes belts which are knotted, jammed, tucked behind the seat, or in any other fashion rendered unusable. In addition, use this attribute for belts which are inoperative because of extreme deterioration from aging. A belt system that was completely removed from or cut out of a vehicle is assigned **None used, not available, or belt removed/destroyed**.

**Shoulder belt**

is used when a manual shoulder belt alone was in use. This can occur when: (1) the vehicle was not equipped with a lap belt, (2) only the shoulder belt portion of a non-integral system was in use, or (3) when the lap belt portion of a noncontinuous loop integral lap and shoulder belt system was cut out leaving only a functional shoulder belt portion in use.

**Lap belt**

is used when a manual lap belt alone was in use. This can occur when: (1) the vehicle was not equipped with a shoulder belt, (2) only the lap belt portion of a non-integral system was in use, or (3) when the shoulder belt portion of a noncontinuous loop integral lap and shoulder belt system was cut out leaving only a functional lap belt portion in use. **Note**, manual lap belts can be used in conjunction with a two-point automatic belt system. For manual and automatic belt combinations, use this attribute for the manual lap belt usage.

**Lap and shoulder belt**

is used when the occupant is: (1) “encompassed” *both* in the lap and upper torso region by a manual lap and shoulder belt combination, or (2) using only a portion of an intact integral lap and shoulder belt system. For example, if a person has an integral lap and shoulder belt but is only using the lap portion (i.e., having the shoulder belt behind his or her back), then use this attribute. Improper use of the belt is assessed in Proper Use of Manual (Active) Belts.

**Belt used — type unknown**

is used when the type of manual belt system cannot be determined.

**Shoulder/lap/lap and shoulder belt used with child seat**

is used when the vehicle’s manual belt system anchors a child safety seat to the vehicle, or when the lap/shoulder belt is used to restrain a child who is sitting on a booster seat. These attributes do not refer to the belts which are part of the child seat itself.

**Belt with child safety seat — type unknown**

is used when the vehicle belt type is unknown, not the child safety seat type.

**Other belt with child safety seat**

is used when a built-in child safety seat is “self contained” (does not use any part of the regular existing manual belt system available at the occupant seating position).

**Unknown if belt used**

is used if it cannot be determined whether or not a manual belt was in use by the occupant at the time of the crash.

## MANUAL (ACTIVE) BELT MALFUNCTION MODES DURING CRASH

Page 1 of 2

Screen Name: Malfunction

SAS Data Set: SEATLOC

SAS Variable: ACTFAIL

Oracle Name: MANUALEATBELT.PICKREASONBELTFAILURE

**Element Attributes:**

Oracle	SAS	
0	0	[None used/not available/removed or destroyed]
1	1	No manual belt malfunction(s)
2	2	Torn webbing (stretched webbing not included)
3	3	Broken buckle or latch plate
4	4	Upper anchorage separated
5	5	Other anchorage separated (specify)
6	6	Broken retractor
7	7	Combination of above (specify)
8	8	Other manual belt malfunction (specify)
9	9	Unknown

Source: Vehicle inspection

**Remarks:**

If any component of the manual belt system malfunctions during the impact as a result of occupant loading, the malfunction is captured in this variable. The malfunction is also recorded on the **Case Form/Summary Tab** and documented with images.

If a malfunction occurs, select the attribute which corresponds to the appropriate manual belt malfunction mode that describes the component of the restraint system which malfunctioned (*i.e.*, torn webbing, broken buckle or latchplate, anchorage separation, broken retractor). A complete and documented description of the malfunctioning component and the way it malfunctioned must accompany the case.

**No manual belt malfunction**

is used when there is no physical evidence from the vehicle inspection to indicate that a malfunction occurred.

**Combination of above (specify)**

is used when any combination of specified attributes occur and describes multiple manual belt malfunction modes. Manual belt malfunction modes which are not described are reported in **other**

**manual belt malfunction.** Manual belt malfunctions **with specific attributes** take priority over the **Other manual belt malfunction** code.

**Other manual belt malfunction (specify)**

is used when the only manual belt malfunction(s) which occur are not described with a specific attribute.

**Unknown**

is used when it can not be determined if the manual belt malfunctioned.

## MANUAL SHOULDER BELT UPPER ANCHORAGE ADJUSTMENT

Page 1 of 2

**Screen Name:** Anchorage Adjustment**SAS Data Set:** SEATLOC**SAS Variable:** ACTANCH**Oracle Name:** MANUALEATBELT.PICKUPPERANCHORPOSITION**Element Attributes:**

Oracle	SAS	
0	0	[No manual shoulder belt]
1	1	None for manual shoulder belt
2	2	In full up position
3	3	In mid position
4	4	In full down position
5	5	Position unknown
6	9	Unknown if adjuster present

**Source:** Vehicle inspection**Remarks:**

Complete this variable regardless of manual shoulder belt usage.

**No upper anchorage adjustment for manual shoulder belt**

is used when a manual shoulder belt is present but there is no adjustment mechanism at the upper anchorage point.

**In full up position**

is used when the manual shoulder belt is equipped with an adjustable upper anchorage point and it was in its highest position at the time of the crash (*e.g.* closest position to the roof).

**In mid position**

is used when the manual shoulder belt is equipped with an adjustable upper anchorage point and it was in a middle position at the time of the crash (somewhere between full up and full down).

**In full down position**

is used when the manual shoulder belt is equipped with an adjustable upper anchorage point and it was in its lowest position at the time of the crash (closest position to the floor).

**Position unknown**

is used when the manual shoulder belt is equipped with an adjustable upper anchorage point but it cannot be determined what the position was at the time of the crash.

**Unknown if adjuster present**

Is used when it cannot be determined if the manual shoulder belt was equipped with an adjustable upper anchorage device. This distinguishes it from "Position unknown".



**RESTRAINTS/MANUAL/COMPONENTS**

Safety Systems Form, Case 2007-996-900015/ Vehicle #1

SEAT | RESTRAINTS | AIR BAG | CHILD SEAT | LOG | REVIEW

MANUAL | AUTOMATIC

FIRST ROW | SECOND ROW | THIRD ROW | FOURTH ROW | FIFTH ROW

BELT | COMPONENTS

Pretensioner [ ] [ ] [ ]

Pretensioner Distance [ ] cm [ ] cm [ ] cm

**Positioning Device**

Presence [ ] [ ] [ ]

Save

**PRETENSIONER PRESENCE/ACTUATION**

Page 1 of 2

**Screen Name:** Pretensioner**SAS Data Set:** SEATLOC, OA**SAS Variable:** ACTPRET**Oracle Name:** MANUALEATBELT.PRETENSEDEPLOYID**Element Attributes:**

Oracle	SAS	
1	0	Not equipped
2	1	Pretensioner not actuated
3	2	Retractor type actuated
7	6	Buckle type actuated
8	7	Retractor and buckle type actuated
6	5	Pretensioner present, Unknown if actuated
-9999	9	Unknown if equipped

**Source:** Presence: Vehicle inspection and or reference material  
 Actuation: Vehicle inspection only.

**Remarks:**

Can tighten the belt up to 15 cm.

When a collision occurs, a seat belt with a pretensioner detects the incident and tightens the belt before the wearer is propelled forward. This holds the occupant more securely in the seat. Usually vehicles with air bags will have pretensioners, but they may be present in seating positions that do not have air bags ('80s Mercedes).

The seat belt pretensioners consist of a housing, an initiator, a canister of gas generating materials, a routing cable with a piston attached, and a piston tube. The initiator is part of the seat belt pretensioner deployment loop. When the vehicle is involved in a collision of sufficient force, a microprocessor causes current to flow through the seat belt deployment loops to the initiator. Current passing through the initiator ignites the material in the canister producing a rapid generation of gas. The gas produced from this reaction actuates the seat belt pretensioners and shortens the seat belt length.

Generally, when a front air bag (instrument panel, steering wheel) deploys, the pretensioner will actuate. However, it is possible for the pretensioner to actuate without the air bag deployment.

Buckle type pretensioner

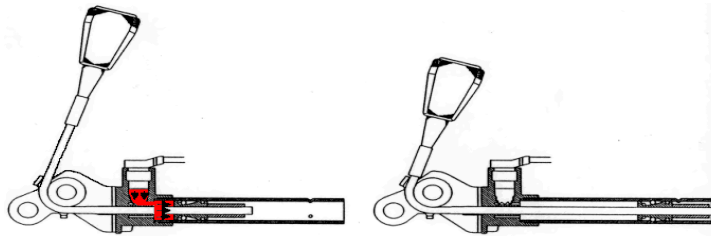

**PRETENSIONER DISTANCE**

**Screen Name:** Pretensioner Distance

**SAS Data Set:** SEATLOC

**SAS Variable:** PRETDIST

**Oracle Name:** DUPMANUALSEATBELT.PRETENSEDISTANCE

**Element Attributes:**

Oracle	SAS	
		Measure to the nearest centimeter
-8887	98	Not applicable
-9999	99	Unknown

**Range:** 0-20

**Source:** Vehicle Inspection

**Remarks:**

If the vehicle is equipped with a buckle type pretensioner and it is actuated measure the distance. The measurement is of the collapse of the seat belt buckle stalk.

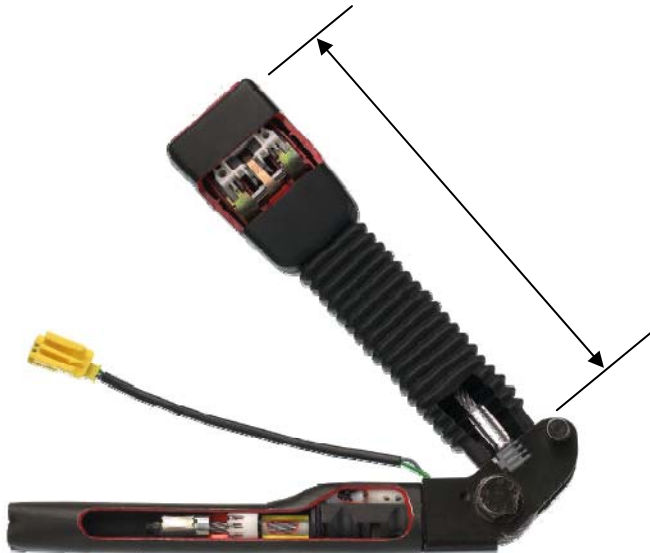

**Screen Name:** Positioning Device Presence

**SAS Data Set:** SEATLOC

**SAS Variable:** IPOSPRES

**Oracle Name:** MANUALEATBELT.BELTPOSDEVICEID

**Element Attributes:**

Oracle	SAS	
1	0	None present
2	1	Buckle Buddy – Shoulder Belt Adjuster
3	2	Sta-n-Place – Shoulder Belt Adjuster
4	3	Belt-A-Way – Shoulder Belt Adjuster
5	4	Shoulder Strap Adjuster – Shoulder Belt Adjuster
6	5	Child Protector – Lap and Shoulder Belt Adjuster
7	6	SafeFit – Shoulder Belt Adjuster
8	7	SafeFit Supreme - Shoulder Belt Adjuster
9	8	Seat Belt Adjuster – Shoulder Belt Adjuster
10	9	Klunk-Klip – Shoulder Belt Adjuster
11	10	Child Safer – Shoulder Belt Adjuster
12	11	Comfort Ride – Shoulder Belt Adjuster
13	12	Belt Buddy
14	97	OEM device
15	98	Other (specify)
-9999	99	Unknown if present

**Source:** Vehicle Inspection

**Remarks:**

This variable is coded for any position containing a shoulder belt. Aftermarket seat belt positioning devices are typically manufactured for use by small stature adults and children to adjust lap and shoulder belt fit and comfort. These products are not considered “safety devices” and are not tested or regulated by NHTSA.

**Other (specify)**

includes belt extension devices. Annotate the name and type of device.



GM rear seat shoulder belt comfort guide



Belt buddy



Buckle buddy



Shoulder strap adjusters

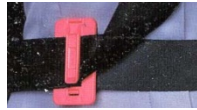

Shoulder strap adjusters



Child safer

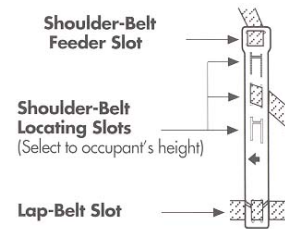

Child safer



## **Air Bag Overview**

Air bags are supplemental restraint systems that are designed to deploy in certain crashes. Both frontal and side-impact air bags can reduce occupant injuries. The Air Bag tab captures information about all air bags in the vehicle. All air bags in the vehicle must be inspected and documented completely; this includes the deployed and non-deployed air bags. Deployed air bags must be inspected to document occupant contacts, damage to the air bag membrane and module cover flaps. All contact evidence, damage, and module cover flap configurations must be documented in the appropriate Sketch tabs. Determination of air bag function and injury causation depends on the complete documentation of this data.

Every air bag for every seating position must be listed in the Air Bag tab; this includes non-deployed air bags. The presence of non-deployed air bags can be more difficult to determine. Most frontal bags are clearly labeled with the embossed letters SRS, SIR or SRS/Air Bag on the air bag cover located in the center of the steering wheel (for the driver) and the instrument panel for the front right occupant. Also look for the air bag warning labels typically located on the sun visor. For Side-impact air bags (SAB), look for the embossed letters SRS or Side Air Bag on areas such as the outboard side of the seatback, the door/panel or the overhead roof rail.

Information on possible air bag presence should be obtained before inspection of the vehicle. This information may be obtained from the current Model Year (MY) Safety Equipment list, Zone Center, owner's manual, body shops, etc.

## **Air Bag Types**

### **Frontal Air Bags**

Frontal air bags have been available in passenger cars since the 1970's. In the mid to late 1980's, air bags became more prevalent. By the late 1990's, air bags became standard in all passenger vehicles.

- Driver's air bags
  - Located in the steering wheel hub
  - Knee air bags located in the lower instrument panel area
- Front right occupant position
  - Located in the top, mid or bottom instrument panel areas

### **Side-impact Air Bags (SAB)**

SABs are designed to lower the incidence of head or torso injuries during side-impact crashes. Some types of SABs may stay inflated for several seconds during a crash for additional protection in the event of a rollover.

There are three main types of SABs: chest (or torso), head and head/chest combination (or “combo”).

- Chest (or torso) SABs are mounted in the side of the seat (seatback mounted) or in the door/panel and are designed to help protect an occupant’s chest in a side-impact crash. Typically chest SABs are present in both front seats, but some newer vehicles have them mounted in the rear outboard seat positions.
- Head SABs are usually mounted in the roof rail above the side windows and are designed to help protect an occupant’s head in a side-impact crash. There are two types of head SABs: inflatable curtains and inflatable tubular structures. Typically, inflatable curtains help protect both front and rear occupants in a side-impact crash; some may also provide protection from ejection in rollover type crashes. In some vehicles, SABs extend and protect occupants in the 3<sup>rd</sup> row.
- Head/chest combination (“combo”) SABs are usually mounted in the side of the seat and are typically larger than chest (torso) air bags. Combinations are designed to help protect both the head and chest of an occupant. Some newer vehicles are equipped with combinations in the rear outboard seat positions.

### **Air Belts**

Air belts are seat belts that expand and provide added restraint and protection for rear seat occupants. The inflatable belts spread the load of the crash forces over a larger part of the body. The bag is located inside the fabric of the seat belt. The air belts are designed for use of the rear outboard occupants.



**AIR BAG**

Safety Systems Form, Case 2007-996-900015/ Vehicle #1

SEAT | RESTRAINTS | AIR BAG | CHILD SEAT | LOG | REVIEW

AIR BAG

Function		Damage	
Location	<input type="text"/>	Flap open at tear pts?	<input type="text"/>
Status	<input type="text"/>	Flap damaged?	<input type="text"/>
Type	<input type="text"/>	Damage to the air bag?	<input type="text"/>
Deployment	<input type="text"/>	Source of damage	<input type="text"/>
Indications of failure	<input type="text"/>		
Switch Type	<input type="text"/>		
Switch Status	<input type="text"/>		

Seat Location  Air Bag  of  View Sketches

**AIR BAG NUMBER FOR THIS VEHICLE**

**Screen Name:** Air Bag

**SAS Data Set:** *AIRBAG*

**SAS Variable:** *BAGNO*

**Oracle Name:** *AIRBAG.AIRBAGNUM*

**Element Attributes:**

Air bag number

**Source:** Vehicle inspection

**Remarks:**

Assigned by the system, one for every single air bag.

If air bags are available for the occupant, indicate the information on all air bags. Do so by inserting another air bag. To insert another air bag, go to the menu bar and select **Edit/Insert**, then indicate its location, and complete the information about the air bag.

**SEAT LOCATION FOR AIR BAG(S) DATA**

**Screen Name:** Seat Location

**SAS Data Set:** *BAGSEAT*

**SAS Variable:** *SEAT*

**Oracle Name:** *Derived*

**Element Attributes:**

Seat Location (based on defined seats for this vehicle)

**Source:** Vehicle inspection

**Remarks:**

Select the seat location from the list of available seats for the available air bag(s).

If air bags are available for the occupant, indicate the information on all air bags. Do so by inserting another air bag. To insert another air bag, go to the menu bar and select **Edit/Insert**, then indicate its location, and complete the information about the air bag.

## DEPLOYMENT LOCATION OF AIR BAG

Page 1 of 2

Screen Name: Function – Location

*SAS Data Set:* AIRBAG*SAS Variable:* BAGLOC*Oracle Name:* AIRBAG.PICKLOCATION**Element Attributes:**

Oracle	SAS	
1	1	Steering Wheel Hub
2	2	Top Instrument Panel
3	3	Mid Instrument Panel
4	4	Bottom Instrument Panel
5	5	Seat Back
8	6	Door/Panel
9	7	Roof Side Rail
6	8	Seat Belt
10	98	Other (specify)
11	99	Unknown

Source: Vehicle inspection

**Remarks:**

Enter the location of the air bag.

**Steering Wheel**

is used for an air bag that is designed to deploy from a module integrated with the steering wheel. It is designed to protect the vehicle's driver primarily from frontal impacts. It does not matter if the steering wheel is located on the right side of the vehicle, still code the location of the air bag to the steering wheel.

**Top Instrument Panel Location**

is used for those air bags that deploy rearward from a location on the top of the instrument panel. They are designed to protect front seat passengers primarily from frontal impacts.

**Mid Instrument Panel Location**

is used for those air bags that deploy rearward from a location in the middle of the instrument panel. They are designed to protect front seat passengers primarily from frontal impacts.

**Bottom Instrument Panel Location**

is used for those air bags that deploy rearward from a location in the bottom of the instrument panel. They are designed to protect front seat passengers primarily from frontal impacts. This includes “knee bags”.

**Seat Back**

is located on the outside portion of the seat back and is designed to protect the torso of occupants primarily from side impacts.

**Door/Panel**

is located in the door is designed to protect the torso of occupants primarily from side impacts. Included in this attribute are air bags that deploy from any side panels.

**Roof Side Rail**

is primarily a curtain type bag that is stored in the roof side rail and is designed to protect the head of occupants primarily from side impacts.

**Seat Belt**

is used for “air belts.” The “air belts” are designed to deploy from seat belts, allowing the forces of the crash to be spread over a large area of the body.

**Other (specify)**

is used when the location of the air bag cannot be captured in the above attributes. This should be a rare occurrence. The location of the air bag must be specified.

**Unknown**

is used when the researcher is unable to determine the location of the air bag.

**AIR BAG STATUS**

**Screen Name:** Function - Status

**SAS Data Set:** *AIRBAG*

**SAS Variable:** *BAGFUNC*

**Oracle Name:** *AIRBAG.PICKAIRBAGFUNCTION*

**Element Attributes:**

Oracle	SAS	
1	1	Air Bag Available
2	2	Air bag disconnected (specify):
3	3	Air bag not reinstalled
4	9	Unknown if air bag available for this crash

**Source:** Vehicle inspection

**Remarks:****Air bag Available**

is used when the vehicle is equipped with an air bag for this seating position. Deployment of the air bag system has no bearing on this variable.

**Air bag disconnected (specify)**

is used when any component of the air bag was rendered inoperative prior to the collision (*e.g.*, fuse removed).

**Air bag not reinstalled**

is used when the air bag for this seating position was not replaced after a prior deployment to the crash being researched.

**Unknown if air bag available for this crash**

is used when it cannot be ascertained whether an air bag was available at the time of the crash.

## TYPE OF AIR BAG

Screen Name: Function—Type

SAS Data Set: *AIRBAG*

SAS Variable: *BAGTYPE*

Oracle Name: *AIRBAG.PICKAIRBAGCLASSID*

**Element Attributes:**

Oracle	SAS	
1	1	Original manufacturer install
3	3	Replacement Air Bag
2	2	Retrofitted Air Bag
-8871	70	[No air bag available for this crash (disconnected/not reinstalled)]
	79	[Unknown status if air bag available for this crash]
4	99	Unknown Type

Source: Vehicle inspection

**Remarks:****Original manufacturer install**

is used when it can be determined that the vehicle was equipped with an air bag system in this seating position that was installed by the manufacturer at the time the vehicle was built (OEM).

**Replacement air bag**

is used when it can be determined that the vehicle was equipped with an OEM air bag system for this seating position, and that this system had been replaced due to a previous deployment.

**Retrofitted air bag**

is used when it can be determined that the vehicle was equipped with an air bag system for this seating position but that the vehicle was not built with a manufacturer equipped air bag system.

This is an after market product and should not be confused with **Replacement air bag**.

Replacement retrofit air bags are also included in this category. Annotate the source of the information.

## AIR BAG DEPLOYMENT

Page 1 of 2

Screen Name: Function—Deployment

SAS Data Set: AIRBAG

SAS Variable: BAGDEPLY

Oracle Name: AIRBAG.PICKAIRBAGDEPLOY

**Element Attributes:**

Oracle	SAS	
1	1	Deployed during crash (as a result of impact)
2	2	Deployed inadvertently just prior to crash
3	3	Deployed, details unknown
4	4	Non-collision deployment
6	7	Not deployed
-8871	70	[No air bag available for this crash (disconnected/not reinstalled)]
-8870	79	[Unknown status if air bag available for this crash]
5	99	Unknown if deployed

Source: Vehicle inspection

**Remarks:****Deployed during crash (as a result of impact)**

is used when the vehicle is equipped with an air bag and the air bag deployed as a result of an impact which produced a longitudinal deceleration through the vehicle of sufficient magnitude to cause inflation of the air bag. Note, an air bag is not designed to deploy in every collision.

**Deployed inadvertently just prior to crash**

is used when an air bag deploys without an impact having caused its deployment, and the vehicle is subsequently involved in an crash.

**Deployed, details unknown**

is used when the researcher cannot determine if the air bag deployed (1) prior to the crash or (2) during the crash as a result of an impact which produced a deceleration through the vehicle of sufficient magnitude to cause inflation of the air bag.

**Non-collision deployment**

is used if the air bag deploys during a crash but not as a result of an impact. For example, a vehicular fire, occurring as a result of:

- an impact or
- a noncollision event

prior to any impacts to this vehicle.



**Unknown if deployed**

is used when it is known that the vehicle was equipped with an air bag but the researcher is unable to determine if the air bag deployed (for whatever reason). For example, if the vehicle was sufficiently damaged so that a determination of deployment cannot be made from the vehicle inspection or the deployment status at the time of the crash cannot be determined.

**Not deployed**

is used when an air bag equipped vehicle has one or more impacts, and the air bag did not inflate during the crash.

**INDICATIONS OF AIR BAG MALFUNCTION**

**Screen Name:** Function—Indications of Malfunction

**SAS Data Set:** *AIRBAG*

**SAS Variable:** *BAGFAIL*

**Oracle Name:** *AIRBAG.PICKAIRBAGFAILURE*

**Element Attributes:**

Oracle	SAS	
1	0	No
2	1	Yes (specify)
-8871	70	[No air bag available for this crash (disconnected/not reinstalled)]
-8870	79	[Unknown status if air bag available for this crash]
3	99	Unknown

**Source:** Vehicle inspection

**Remarks:**

This variable flags “indications of an air bag malfunction” and means that something abnormal has occurred to the air bag system. It may not necessarily mean that the air bag system was defective. A vehicle inspection is required in order to report an indication of air bag malfunction.

**No**

is used whenever the air bag deployed and there are no obvious visual indications of an air bag malfunction.

**Yes (specify)**

is used whenever an indication of an air bag malfunction is suspected and specify the malfunction. An indication of an air bag malfunction could be a blowout of the fabric, a rupture along a fabric seam, a cover which does not open properly causing a misaligned deployment, partial inflation, or any number of other problems. If an indication of an air bag malfunction is suspected, then document the condition with images and then call your zone center for assistance.

**Unknown**

is used when it is not known if the bag malfunctioned.

**TYPE OF CUTOFF SWITCH**

**Screen Name:** Function -- Switch Type

**SAS Data Set:** *AIRBAG*

**SAS Variable:** *SWITCHTYP*

**Oracle Name:** *AIRBAG.SWITCHTYPE*

**Element Attributes:**

Oracle	SAS	
0	0	None present
1	1	Originally equipped
2	2	Retrofit
3	3	Switch present, type unknown
4	9	Unknown if switch present

**Source:** Vehicle inspection

**Remarks:**

This variable captures only manually operated switches, typically installed by the manufacturer. Air bag cutoff switches were designed to be installed by manufacturers in vehicles with only one row of occupant seating. This was done so that if a child seat was used, the air bag could be turned off. More recently NHTSA has permitted the public to request air bag cutoff switches to be installed by dealers. The retro fit switch can be located in the glove compartment. **Close up images of the switch are required.**

**None present**

is used when there is no air bag cutoff switch present for this occupant position.

**Originally equipped**

is used when a vehicle is originally equipped by the manufacturer with an air bag cutoff switch for this occupant position is present. This switch will not be present for the driver's position.

**Retrofit**

is used when an air bag cutoff switch for this occupant position has been added.

**Switch present, type unknown**

is used when an air bag cutoff switch for this occupant position is present and it is not known if it is original or retro fit.

**Unknown if switch present**

is used when it is not known if an air bag cutoff switch is present.

**CUTOFF SWITCH POSITION STATUS**

**Screen Name:** Function—Switch Status

**SAS Data Set:** *AIRBAG*

**SAS Variable:** *SWTCHSET*

**Oracle Name:** *AIRBAG.SWITCHSTATUS*

**Element Attributes:**

Oracle	SAS	
0	0	Switch on/Automatic
1	1	Switch off
4	7	[None present]
3	8	[Unknown if switch present]
2	9	Switch status unknown

**Source:** Vehicle inspection

**Remarks:**

Air bag cutoff switches were designed to be installed by manufacturers in vehicles with only one row of occupant seating. This was done so that if a child seat was used, the air bag could be turned off. NHTSA has permitted the public to request air bag cutoff switches to be installed by dealers. The retro fit switch can be located in the glove compartment. **Close up images of the switch are required.**

**Switch on/Automatic**

is used when an air bag cutoff switch for this occupant position is present and is in the on position or the Automatic position.

**Switch off**

is used when an air bag cutoff switch for this occupant position is present and is in the off position. The switch manually rendered the air bag inoperative.

**Switch position unknown**

is used when an air bag cutoff switch for this occupant position is present and its position is unknown.

**None present**

is precoded when there is no air bag cutoff switch present for this occupant position.

**Unknown if switch present**

is precoded when it is not known if an air cutoff switch is present.

**DID AIR BAG MODULE COVER FLAP(S)/SEAMS OPEN AT DESIGNATED TEAR POINTS?****Screen Name:** Damage – Flap Open at Tear Points?**SAS Data Set:** AIRBAG**SAS Variable:** BAGFLOPN**Oracle Name:** AIRBAG.PICKCOVERFLAPSOPEN**Element Attributes:**

Oracle	SAS	
1	0	No
2	1	Yes
-8885	60	[Air bag did not deploy]
4	69	[Unknown if air bag deployed]
-8871	70	[No air bag available for this crash (disconnected/not reinstalled)]
-8870	79	[Unknown status if air bag available for this crash]
3	99	Unknown flaps/seams opened at tear points

**Source:** Vehicle inspection**Remarks:**

A designated tear point is a weakened area of the flap material designed to allow the air bag easy escape from its storage area during deployment. Some air bags in the seat cushion and seat back may not have cover flaps, but will deploy through a seam that separates during the air bag deployment.

**No**

is used when it can be determined that the module cover flap(s) for this air bag opened somewhere other than their designated tear points. A non-linear tear in the flap is an indication that the flap opened irregularly, not at the designated tear point.

**Yes**

is used when it can be determined that the module cover flap(s) for this air bag opened up at their designated tear points. Linear and symmetrical tears are good indications of proper separation of the cover flap(s) at their designated tear points.

**Unknown if flaps/seams open at tear points**

is used when it is not known if the air bag opened at the tear points.

**WERE THE COVER FLAP(S) DAMAGED**

**Screen Name:** Damage—Flap Damaged

**SAS Data Set:** *AIRBAG*

**SAS Variable:** *BAGFLDAM*

**Oracle Name:** *AIRBAG.PICKCOVERFLAPSDAMAGE*

**Element Attributes:**

Oracle	SAS	
1	0	No
2	1	Yes (specify)
-8885	60	[Not Deploy]
4	69	[Unknown if deployed]
-8871	70	[No air bag available for this crash]
-8870	79	[Unknown if air bag available for this crash]
3	99	Unknown if flaps damaged

**Source:** Vehicle inspection.

**Remarks:****No**

is used when it can be determined that no damage was present on the air bag module cover flap(s). Normal separation/tearing at the designated tear points does not constitute damage.

**Yes (specify)**

is used when it can be determined that the air bag module cover flap(s) sustained damage. Abnormal separation/tearing at the designated tear points constitutes damage. Damage can also be cuts, tears, holes, burns, abrasions, etc. The researcher must specify the type of damage that is being reported.

**Unknown if flaps damaged**

is used when it cannot be determined if the air bag flap(s) sustained damage.

**WAS THERE DAMAGE TO THE AIR BAG?**

Page 1 of 2

**Screen Name:** Damage—Damage to the Air Bag?**SAS Data Set:** AIRBAG**SAS Variable:** BAGDAMAG**Oracle Name:** AIRBAG.PICKAIRBAGDAMAGE**Element Attributes:**

Oracle	SAS	
1	0	Not damaged
		<b>Yes — Air Bag Damaged</b>
2	1	Ruptured
3	2	Cut
4	3	Torn
5	4	Holed
6	5	Burned
7	6	Abraded
97	60	[Air bag did not deploy]
11	69	[Unknown if air bag deployed]
-8871	70	[No air bag available for this crash (disconnected/not reinstalled)]
-8870	79	[Unknown status if air bag available for this crash]
8	88	Other damage (specify)
9	95	Damaged, details unknown
10	99	Deployed, unknown if damaged
-8872	96	Post crash damage

**Source:** Vehicle inspection**Remarks:**

If multiple damage types apply select the attribute that most deteriorates the effectiveness of the air bag. If you cannot make this determination then select the attribute in a hierarchical manner from the top of the list down.

**Not damaged**

is used when no damage to the air bag for this occupant position was sustained.

**Ruptured**

describes damage to the air bag that resembles a stellate or starlike pattern of damage, with multiple tears originating from a single point of origin.

Was there damage to the air bag? (cont'd)

Page 2 of 2

**Cut**

describes openings in the air bag which are generally linear and have smooth edges.

**Torn**

describes openings which have ragged edges but which are generally linear in appearance.

**Holed**

describes damage which is circular in appearance with or without ragged edges.

**Burned**

describes damage resulting from heat which scorches, melts or burns the bag.

**Abraded**

is a pattern of damage to the surface of the bag that appears as a fraying of the surface threads.

**Other damage (specify)**

is used to describe damage which is not captured in any of the attributes above.

**Damaged, details unknown**

is used when it is known that the air bag sustained damage, but the type of damage cannot be determined.

**Deployed, unknown if damaged**

is used when it cannot be determined if the air bag sustained damage.

**Post crash damage**

is used when rescue or emergency efforts caused damage to the air bag. Also, use this for damage caused by towing.



**SOURCE OF AIR BAG DAMAGE**

Page 1 of 2

**Screen Name:** Damage—Source of Damage**SAS Data Set:** AIRBAG**SAS Variable:** BAGDAMSO**Oracle Name:** AIRBAG.PICKSOURCEOFDAMAGE**Element Attributes:**

Oracle	SAS	
2	1	Object worn by occupant (specify)
3	2	Object carried by occupant (specify)
4	3	Adaptive/assistive controls, (specify)
12	4	Cover flaps
5	5	Fire in vehicle
6	6	Thermal burns
13	7	Glazing
1	50	[Air Bag Not Damaged]
10	59	Deployed, unknown of damaged
97	60	[Air bag did not deploy]
11	69	[Unknown if air bag deployed]
-8871	70	[No air bag available for this crash (disconnected/not reinstalled)]
-9999	79	[Unknown status if air bag available for this crash]
8	88	Other damage source (specify)
9	99	Damaged unknown source [Post crash damage]

**Source:** Vehicle inspection**Remarks:**

This is a hierarchical variable, that is, if more than one element applies, then select the first attribute that applies.

**Object worn by occupant (specify)**

is selected when the object is fastened, attached, or worn by the occupant. Be sure to specify the object.

**Object carried by occupant (specify)**

is used when the object is held in the mouth, the hand(s), arm(s), etc., by the occupant. Be sure to specify the object.

**Adaptive/assistive controls (specify)**

is used when adaptive/assistive controls damages the air bag for this occupant position. Be sure to specify the object / control.

**Fire in vehicle**

is used when there was a fire in the occupant compartment which damaged the air bag.

**Thermal burns**

is used when the air bag is burned or scorched by the inflation or chemicals.

**Other damage source (specify)**

is used whenever there is damage to the air bag and it cannot be fit into any of the categories above.

**Damaged, unknown source**

is used when there is damage to the air bag, but the source of the damage cannot be determined.

Air Bag/Sketches/Driver

Sketch 1: Damage and Contact Evidence on Driver Air Bag

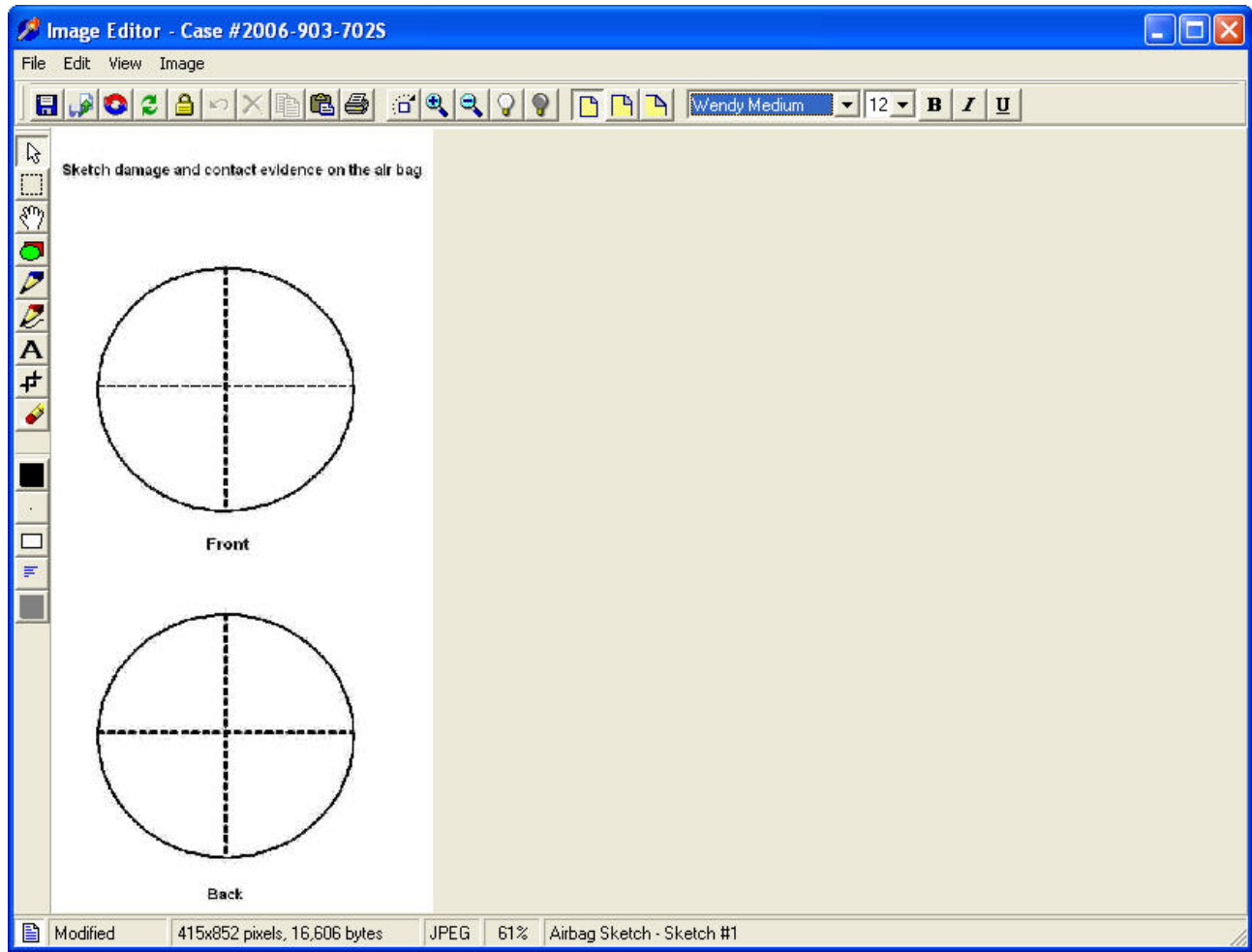

Air Bag/Sketches/Driver

Sketch 2: Driver Air Bag Module Cover Flap

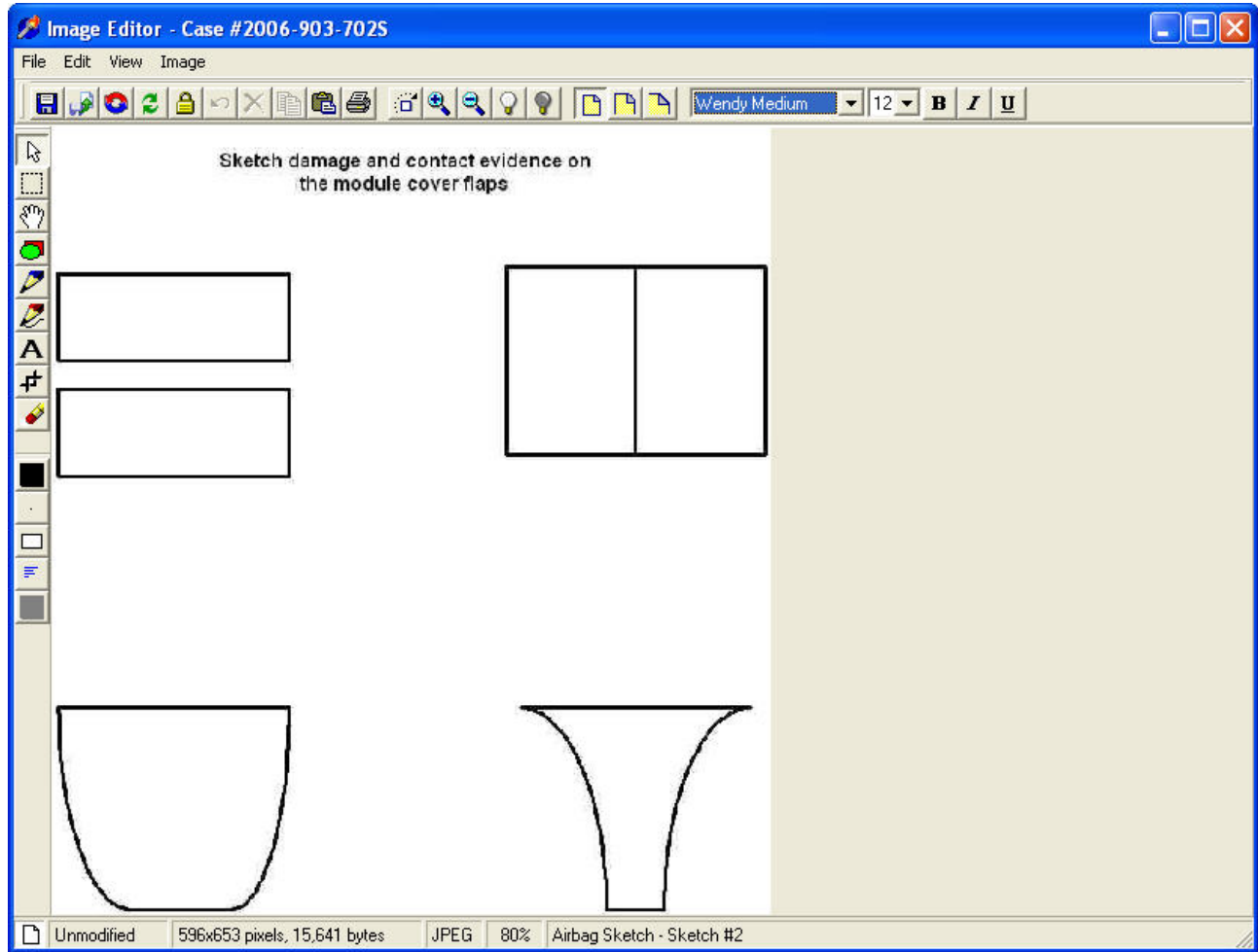

Air Bag/Sketches/Driver

Sketch 3: Sketch of Other Type of Air Bag Module

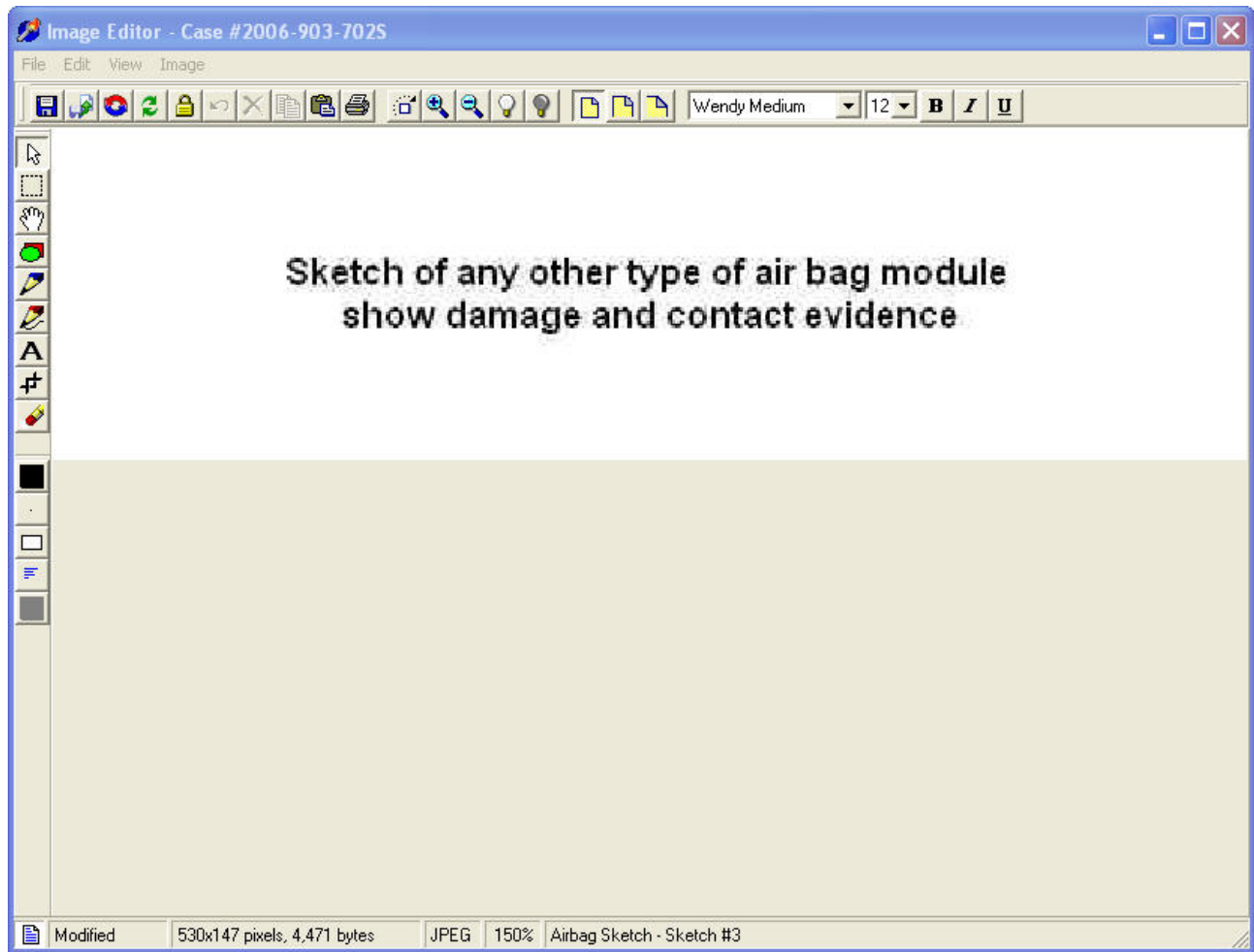

Air Bag/Sketches/Passenger

Sketch 1: Damage and Contact Evidence on Passenger Air Bag

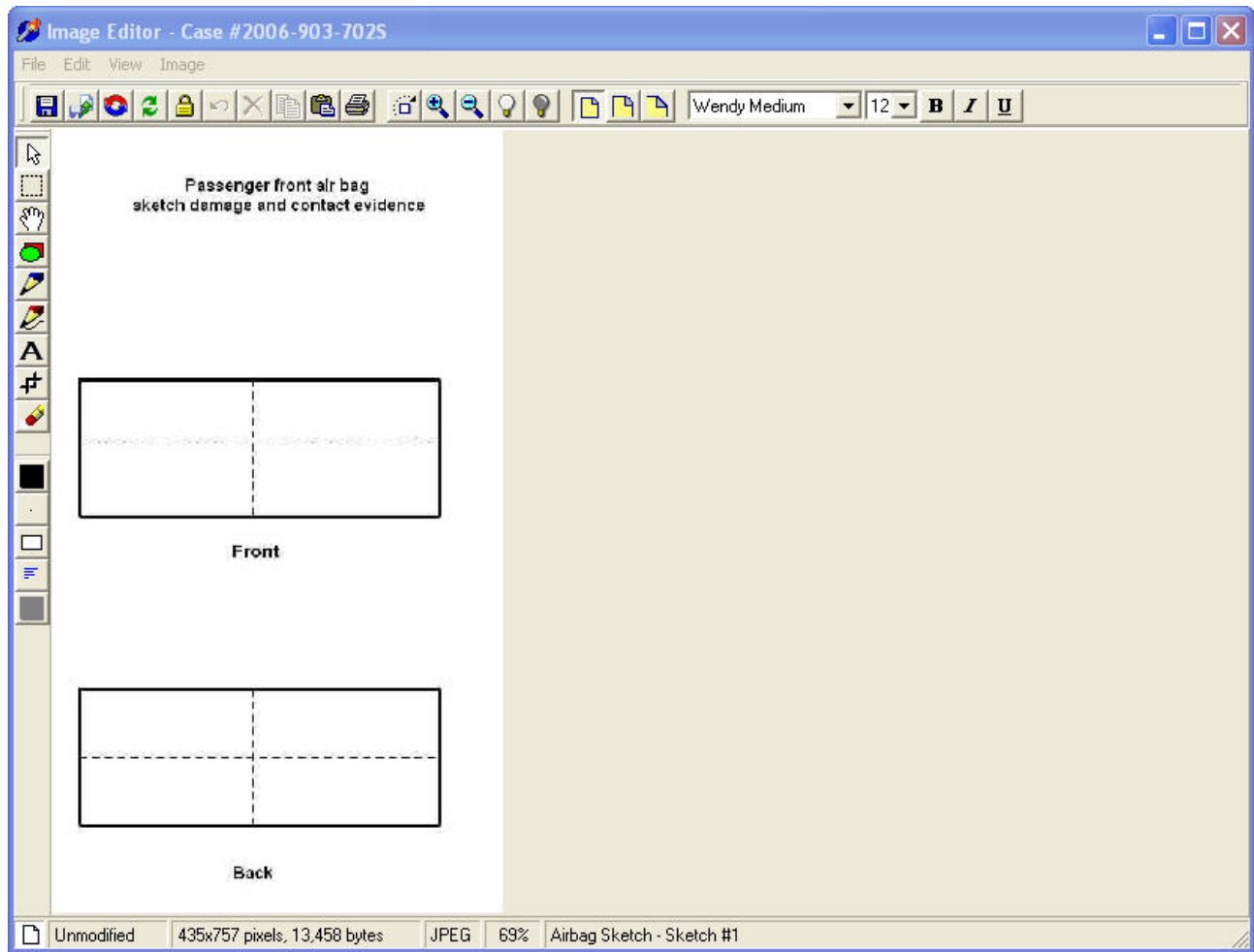

Air Bag/Sketches/Passenger

Sketch 2: Sketch Damage and Contact Evidence on Passenger Air Bag Module Cover Flap

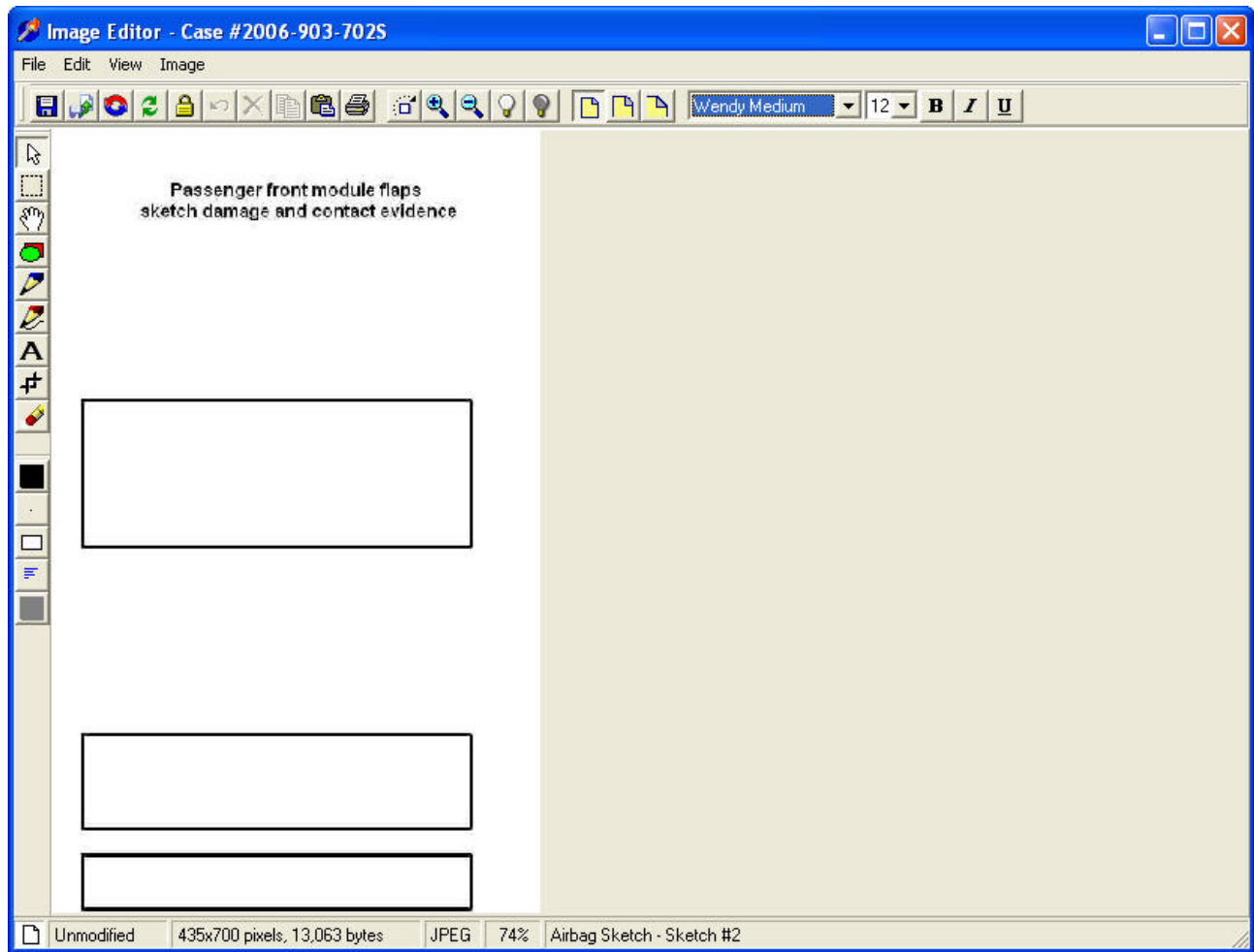

Air Bag/Sketches/Passenger

Sketch 3 Sketch any other Passenger Air Bag Module Flaps

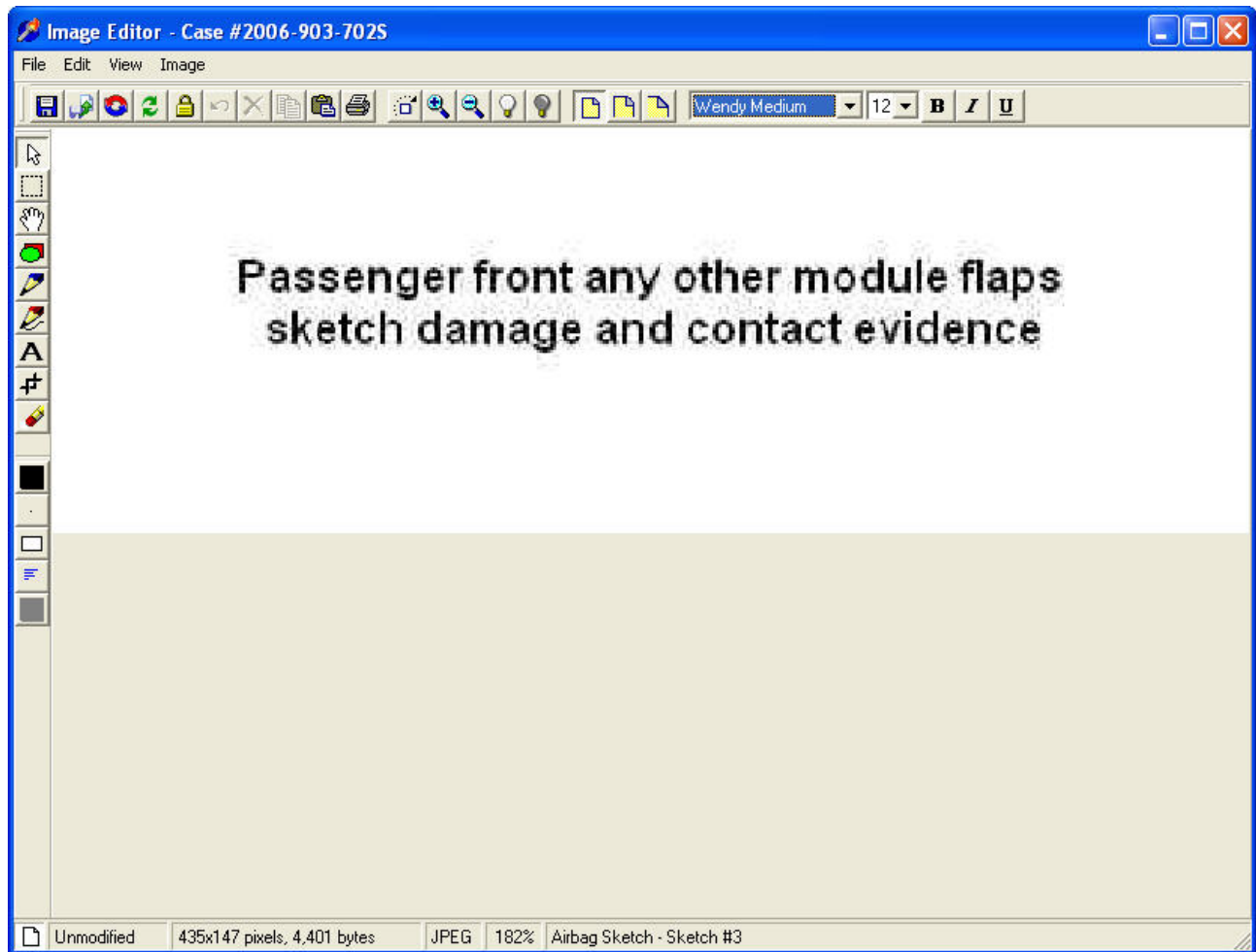



Air Bag/Sketches/Door Mounted

Sketch 1: Damage and Contact Evidence on Door Mounted Bag

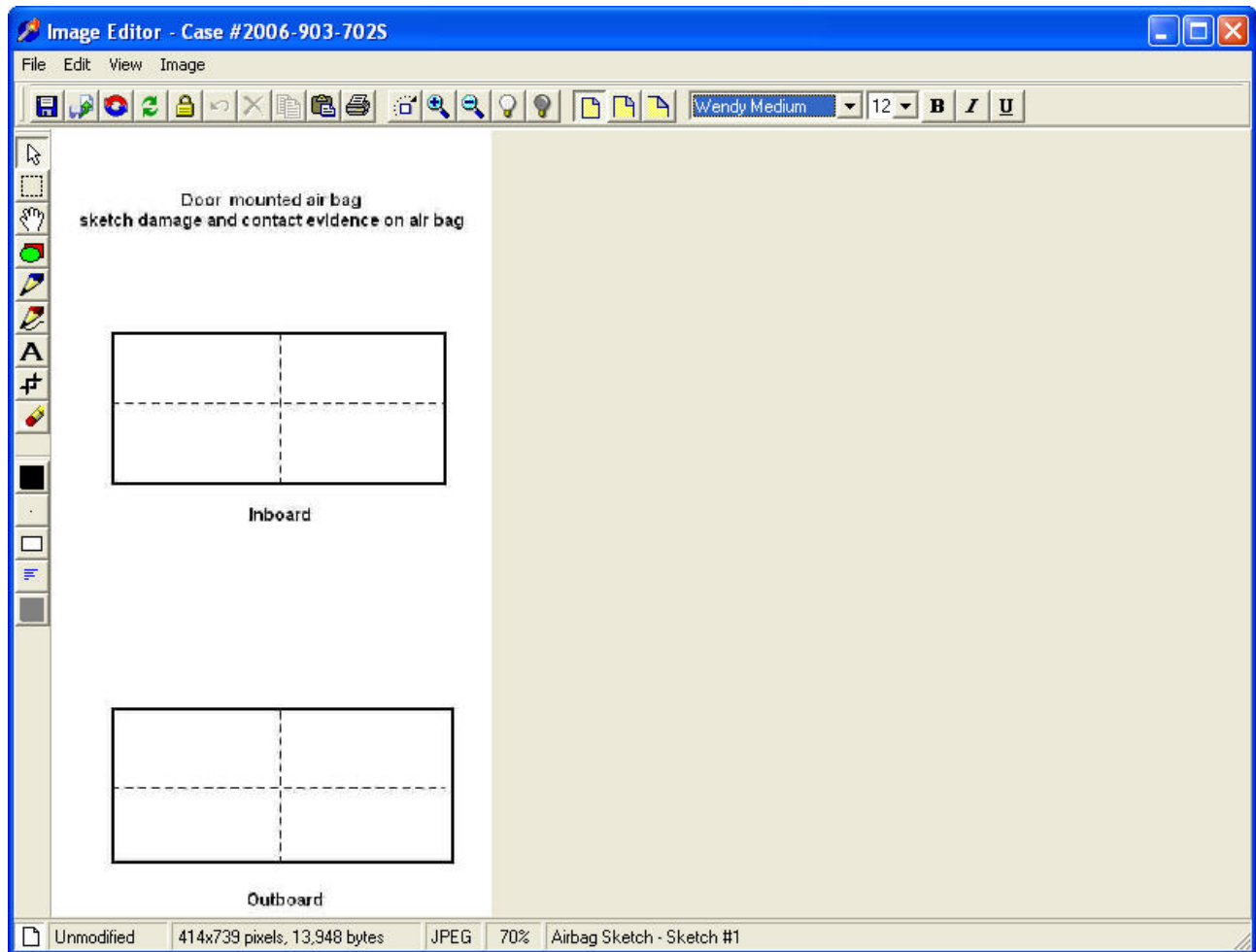

Air Bag/Sketches/Door Mounted

Sketch 2: Sketch any other Damage and Contact Evidence

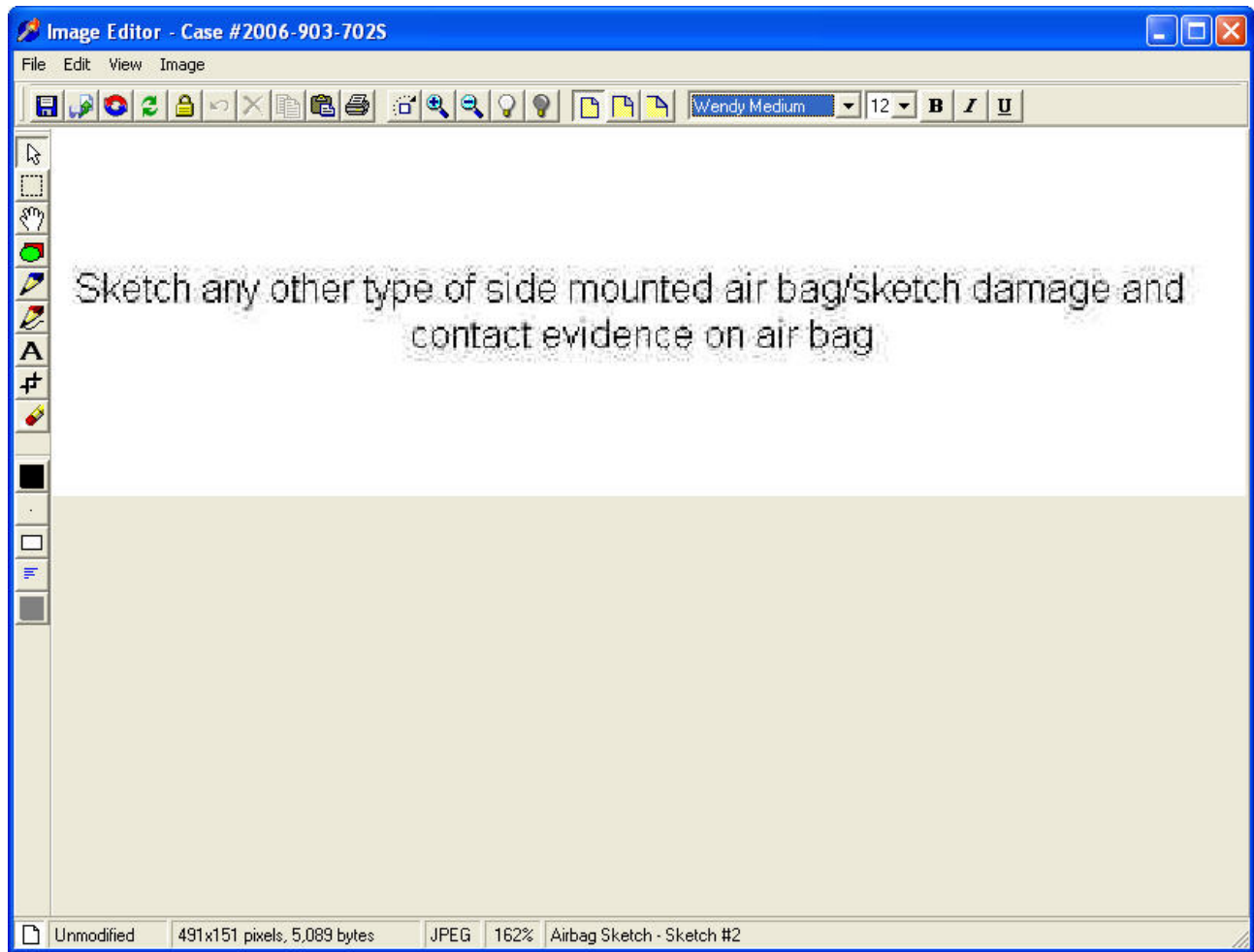

Air Bag/Sketches/Seat Back Mounted

Sketch 1: Damage and Contact Evidence on Seat Back Mounted Bag

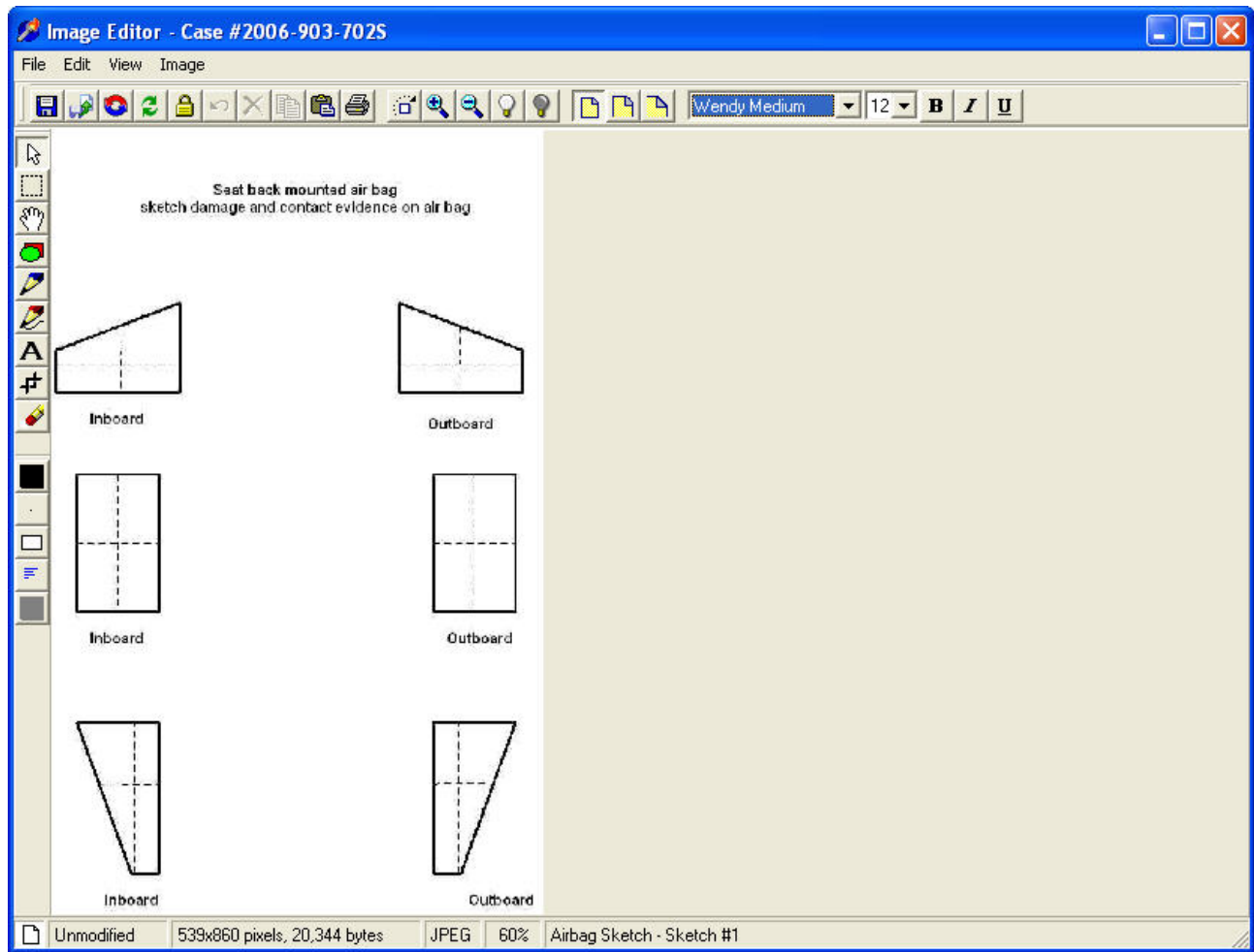

Air Bag/Sketches/Side Curtain or Tube Style Air Bag

Sketch 1: Damage and Contact Evidence on Side Curtain/Tube Bag.

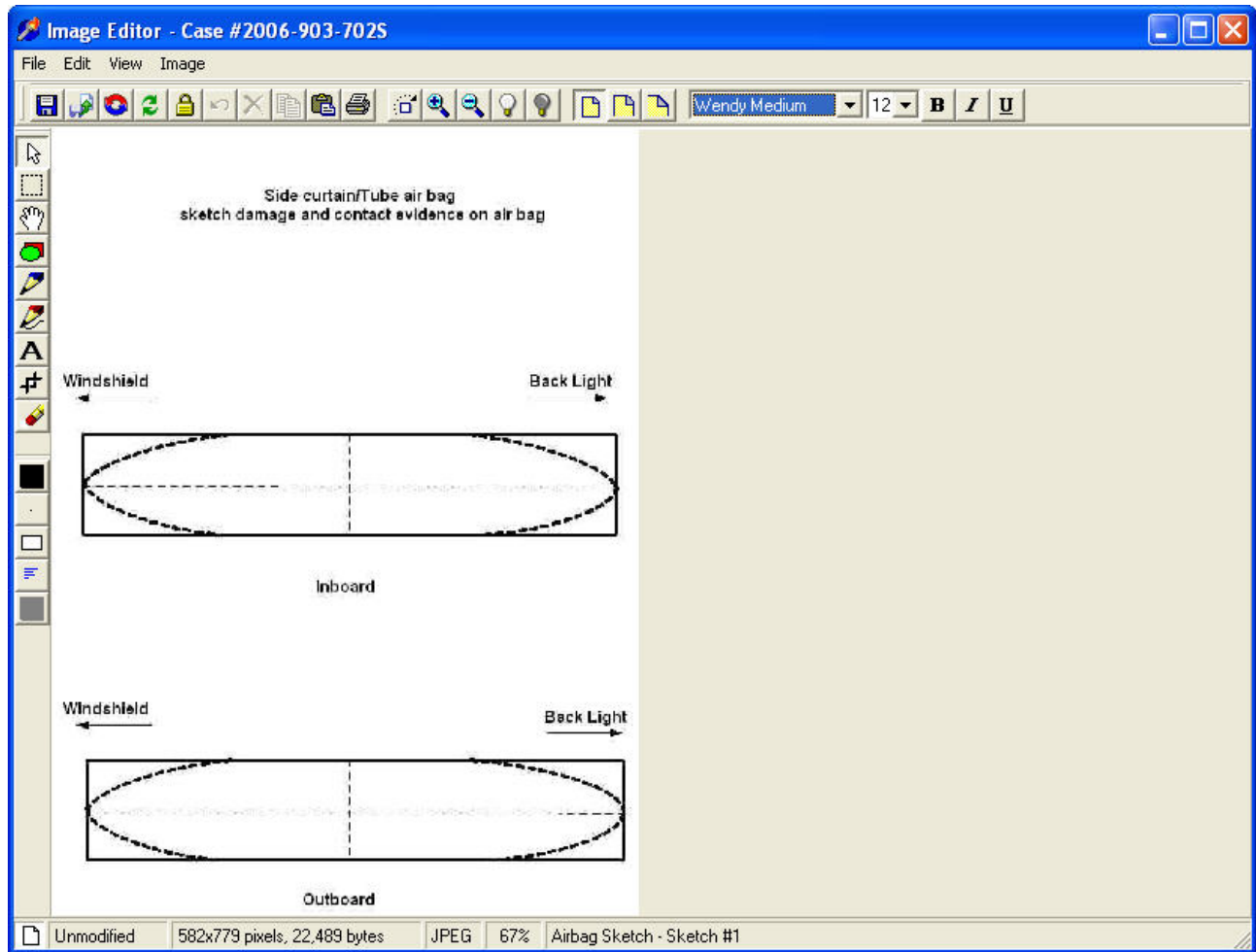

**SAFETY SYSTEM FORM**

**AIR BAG/SKETCHES**

Air Bag/Sketches/Side Curtain or Tube Style Air Bag

Sketch 2: Damage and Contact Evidence on Any other Side Curtain/Tube Bag.

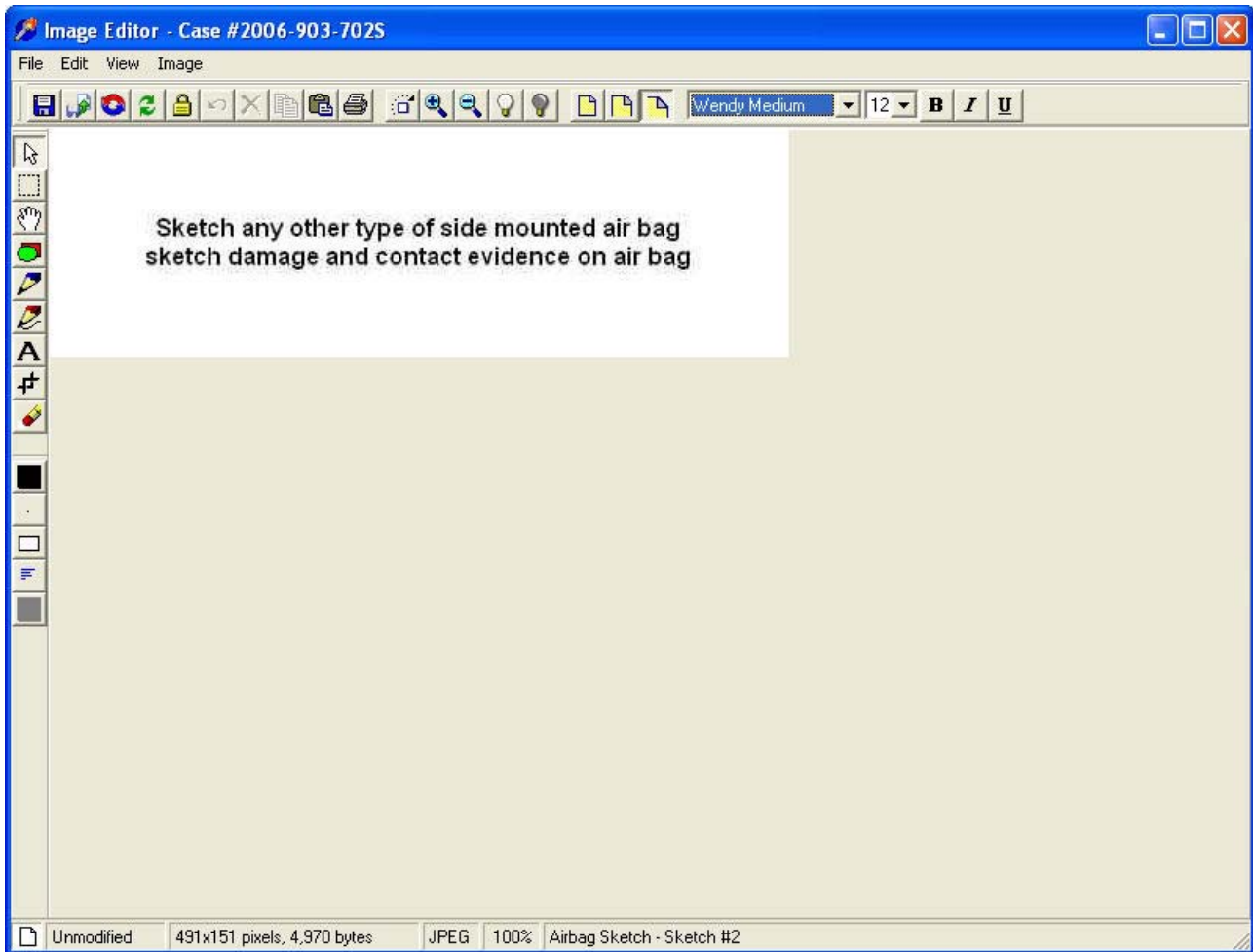

**Child Restraint Overview**

Page 1 of 2

The National Automotive Sampling System (NASS) is the premier data collection system of real-world crashes and as such it is relied upon to deliver data on high profile vehicle safety components such as child restraints. Complete and thorough documentation in this area is an essential element for the agency to achieve its mission. The variables on the Safety System and Occupant forms were designed to document the usage of Child Restraint Systems (CRS) installed in towed CDS applicable vehicles involved in crashes.

Motor vehicle crashes are the leading cause of death and disability for pediatric and adolescent children, and child passenger safety has long been an agency concern. Accordingly, there continues to be a need to collect and compile data on children involved in crashes. Data collected in the past have shown that children may become out of place when they are not secured properly within a CRS. Children frequently escape the CRS' internal harness and in some instances kneel or stand on the vehicle's seat cushion instead of remaining secured in the CRS. In other cases the child is placed within the CRS; however, the caregiver improperly restrained the child and/or incorrectly secured the CRS within the motor vehicle. Historically, correct use and installation of a CRS is a highly effective means of reducing the incidence of serious injury and death to children.

Most states have attempted to address the issue of child safety in motor vehicles with legislation requiring children to be restrained within a CRS and seated in the back row(s) of vehicles. These efforts have resulted in a sharp reduction of injuries and deaths among children, but more data related to the real-world use and performance of child restraints needs to be collected annually. One past and present source of child restraint data is the Police Accident Report (PAR); however, frequently, the PAR provides inaccurate or incomplete data on the type of CRS and how the child was positioned within it.

The National Highway Traffic Safety Administration (NHTSA) enacted two Federal Motor Vehicle Safety Standards (FMVSS) related to child occupant protection; they are: No. 213, Child Restraint Systems and No.225, Child Restraint Anchorage Systems [e.g., Lower Anchors and Tethers for Children (LATCH)]. Within these standards was the requirement that the testing and performance of child restraints would be under the purview of NHTSA and all CRS and vehicle manufacturers would be required to meet these standards. NHTSA performs controlled testing of child seats in laboratories and crash test facilities, and NASS data is collected to augment this research. Analysts will compare usage, injury severity, and delta V data to assess performance levels among different child restraints. After these analyses, the existing standards will be evaluated to determine their effectiveness and whether updates are warranted. These data also assist the agency in identifying any significant problems common among any particular child restraint types.

When discovering that a child was present within a CDS applicable vehicle, the researcher should ***conduct the inspection under the presumption that a CRS was present and occupied*** during the crash. In many cases, the CRS will have already been removed by the police and/or emergency personnel and may be in the possession of the owner, the police jurisdiction, or the treating hospital/trauma center.

When the CRS is not present in the vehicle at the time of the inspection, the researcher should make continual attempts to locate and inspect the CRS. Once located, the inspection shall consist of a detailed examination of the CRS, highlighting any observable damage; the internal harness, including evidence on the webbing (stretching, transfers, burn marks, etc.); height/weight/age recommendations (recorded from labeling on the CRS shell); make/model data (also recorded from labeling on the CRS shell); and evidence within the belt paths. After recording the data, a comprehensive set of digital images shall be taken of the CRS, including any damage, and all CRS labeling.

In addition to the physical inspection of the CRS, a comprehensive interview with the parent/caregiver is vital toward understanding how the CRS was installed in the vehicle and how the child was positioned and restrained during the crash. Information, including what the child was wearing, where the chest retainer clip was positioned, the height and weight of the child and the location of the CRS within the vehicle is critical to understanding whether the CRS functioned as it was designed. Each CRS within the vehicle should be documented regardless of whether it was occupied at the time of the crash.

Some vehicles, specifically some types of minivans and sport utility vehicles, integrate a CRS into the second and third rows of the vehicle. These types of child restraints are termed *integrated child restraint systems*, and they should be documented regardless of whether the CRS was occupied at the time of the crash.

**CHILD SEAT LIST**

Safety Systems Form, Case 2011-999-901575/ Vehicle #1

SEAT | RESTRAINTS | AIR BAG | CHILD RESTRAINT | LOG | REVIEW

LIST | DETAIL

Make	Model	Occ #	Seat

Save Close



**CHILD SEAT DETAIL**

Safety Systems Form, Case 2011-999-90157S/ Vehicle #1

SEAT | RESTRAINTS | AIR BAG | CHILD RESTRAINT | LOG | REVIEW

LIST | DETAIL

CHILD RESTRAINT | VEHICLE

Make	<input type="text"/>	Occ #s	<input type="text"/>
Model	<input type="text"/>	Date of Manufacture	<input type="text"/>
Model No	<input type="text"/>	Type	<input type="text"/>
		How Used	<input type="text"/>
Data Source	<input type="text"/>		

Design Feature Available		How Feature Used	
	Orientation	<input type="text"/>	<input type="text"/>
Harness/ Shield	<input type="text"/>	<input type="text"/>	<input type="text"/>
Retainer Clip	<input type="text"/>	<input type="text"/>	<input type="text"/>
Tether	<input type="text"/>	<input type="text"/>	<input type="text"/>
LATCH	<input type="text"/>	<input type="text"/>	<input type="text"/>
	Belt Routing / Use	<input type="text"/>	<input type="text"/>
	Locking Clip Use	<input type="text"/>	<input type="text"/>

Seat Location  Placement  Child Position

**[CHILD RESTRAINT NUMBER]**

**Screen Name:** N/A

**SAS Data Set:** *CHILDSEAT*

**SAS Variable:** *CHSEATNO*

**Oracle Name:** *CHILDSEAT.CHILDSEATID*

**Element Attributes:**

**Source:** As created by the system.

**Remarks:**

**CHILD RESTRAINT MAKE****Screen Name:** Make**SAS Data Set:** *CHILDSEAT***SAS Variable:** *CHMAKE***Oracle Name:** *CHILDSEAT.CHILDSEATMAKEID***Element Attributes:**

Oracle SAS

997 Refer to listing of Child Restraints  
Other make (specify)  
-999 Unknown make

**Source:** Vehicle inspection, child safety seat inspection, interview**Remarks:**

The manufacturer/make name is usually stamped, sewn or molded onto the exterior surface of the CRS. Removal of padding from the CRS, and an examination of the shell, may be necessary to identify the make, model, serial no. and/or date of manufacture of the CRS. The CRS owner's manual, when available, is a valuable source of information and should be referred to by the researcher. The CRS should also have a label permanently attached that identifies the restraint's date of manufacture and model number; this information alone may be used to identify the specific manufacturer and make of seat if no other identifiers exist. In the absence of any other identifying information, take several digital images of the CRS. Those images, used with other resources, are helpful in identifying the make and model of the CRS at a later date. When the make of the CRS cannot be determined, the attribute **unknown make** should be selected.

**CHILD RESTRAINT MODEL**

**Screen Name:** Model  
**SAS Data Set:** *CHILDSEAT*  
**SAS Variable:** *CHMODEL*  
**Oracle Name:** *CHILDSEAT.PICKMODELID*

**Element Attributes:**

Oracle	SAS	Refer to listing of child restraints
-998		Other (specify)
-999		Unknown model

**Source:** Vehicle inspection, child safety seat inspection, interview

The manufacturer/make name is usually stamped, sewn or molded onto the exterior surface of the CRS. Removal of padding from the CRS, and an examination of the shell, may be necessary to identify the make, model, serial no. and/or date of manufacture of the CRS. The CRS owner’s manual, when available, is a valuable source of information and should be referred to by the researcher. The CRS should also have a label permanently attached that identifies the restraint’s date of manufacture and model number; this information alone may be used to identify the specific manufacturer and make of seat if no other identifiers exist. In the absence of any other identifying information, take several digital images of the CRS. Those images, used with other resources, are helpful in identifying the make and model of the CRS at a later date. When the model of the CRS cannot be determined, the attribute **unknown make** should be selected. The image below illustrates a typical CRS label.



**Date of Manufacture:** 20AUG01 (August 20, 2001)  
**Model Number:** 2501176 P1

## CHILD RESTRAINT TYPE

Page 1 of 8

Screen Name: Type

SAS Data Set: CHILDSEAT

SAS Variable: CHTYPE

Oracle Name: CHILDSEAT.PICKCHILDSEATTYPE

## Element Attributes:

Oracle	SAS	
1	1	Infant seat (ISS)
2	2	Convertible seat (CSS)
3	3	Forward facing only (FSS)
4	4	Booster seat (BSS)
5	5	Booster/Forward facing seat (BSS/FSS)
6	6	Booster/Convertible facing seat (BSS/CSS)
7	7	Integrated seat (INT)
8	8	Harness (HSS)
9	9	Vest (VSS)
10	10	Special needs (SNSS)
98	98	Other (specify)
-99	99	Unknown

Source: Vehicle inspection, child safety seat inspection, interview

## Remarks:

Once the CRS has been identified by its make and model, the CRS *type* will sometimes automatically be defined. **Since this variable represents how the CRS was designed to be used,** this information should be determined during the child seat inspection and/or by asking appropriate questions during the interview. The type of CRS can be determined in the absence of the make and model names.

## CHILD RESTRAINT HOW USED

Page 1 of 8

Screen Name: How Used

SAS Data Set: *CHILDSEAT*SAS Variable: *CHHOWUSED*Oracle Name: *CHILDSEAT.PICKHOWUSED***Element Attributes:**

Oracle	SAS	
1	1	Infant seat (ISS)
2	2	Forward facing only (FSS)
3	3	Booster seat (BSS)
4	4	Integrated seat (INT)
5	5	Harness (HSS)
6	6	Vest (VSS)
7	7	Special needs (SNSS)
98	98	Other (specify)
-99	99	Unknown

**Source:** Vehicle inspection, child safety seat inspection, interview

**Remarks:**

**Since this variable represents how the CRS was actually used**, this information should be determined during the child seat inspection and/or by asking appropriate questions during the interview. How the CRS was used can be determined in the absence of the make and model names.

The following seven pages outline the different types of child restraints a researcher will encounter during a crash investigation.

**Infant Safety Seat (ISS)**

Designed and intended to be used as *rear-facing only* by newborns and infants weighing up to approximately 22 pounds and are typically equipped with either a 3- or 5-point harness. Some infant seats have detachable bases which can be left secured in the vehicle while the infant seat is removed and used as a carrier. When used in the vehicle as a child restraint, the carrier-type infant seat’s carrying handle should be folded back in the down position in most cases, and the CRS should recline at a 45-degree angle (carrying handle instructions and angles vary by manufacturer).

Infant seats are typically designed with 2 or 3 sets of harness strap slots in the back of the CRS which allows for proper harness strap placement (always adjusted at or below the infant’s shoulders). Most harness adjustment mechanisms are mounted behind the seat back and affixed/locked by a metal bar, or clip-type lock. These types of child restraints are also normally equipped with a harness retainer clip that should be positioned to the infant’s armpit level. Either the vehicle’s belt system (lap or lap portion of a lap/shoulder belt) or the lower LATCH anchors must be used to secure the seat and/or its base to the vehicle.



**Common infant seat with detachable base**



**LMY infant seat**



**LMY infant seat equipped with foot brace to abut seat back**

**Convertible Safety Seat (CSS)**

Designed and intended to be used either rear or forward facing for children ranging from birth to approximately 40 pounds (usage restrictions will normally be found on the CRS labeling as well as in the owner’s manual). All convertible seats have a harness system to secure the child to the CRS. The most common system consists of a 5-point harness with a harness retainer clip that should be adjusted to the armpit level of the child. Although not as common, some child seats may have a T-shield or tray-shield. Note: T- and tray-shield designs have been phased out as manufacturers have not employed this design in several years; however, they are still being used by small numbers of people.

Most convertible seats employ three or more sets of harness slots located on the CRS seat back which are used to adjust the height of the harness; proper slot usage is based on the age and size of the child. Generally, the lowest and middle slots are used when the CRS is in a rear facing orientation and the top slots are used when the CRS is used forward-facing (the slot position requirements vary by manufacturer). Child seats used in a rear facing orientation typically range from the birth of the child up to 20 pounds. Some seats have a range that extends to as high as 40



CRS with 5-point harness



CRS with T-shield



CRS with tray-shield

pounds. Refer to the CRS labeling and the owner’s manual for the height and weight requirements for each CRS.

Either the vehicle’s lap and shoulder safety belt system or the Lower Anchors and Tethers for Children (LATCH) system must be used to secure the child seat into the vehicle. As of 2011 it was still not recommended to use both systems simultaneously. However, the top tether should be used in conjunction with either system when in a forward-facing orientation. The LATCH system can only be used when both the CRS and vehicle are equipped with LATCH attachments.



**Forward Facing Only Safety Seat (FSS)**

A forward facing only safety seat is intended to be used by children who are over one year of age and who weigh between 20 and 40 pounds. The majority of these seats are equipped with an internal harness and adjustable chest retainer clip; however, some earlier models were designed as a backless booster safety seat with an attached shield. Most forward-facing seats are equipped with three sets of harness slots that allow for the adjustment of the harness straps, at or above the shoulders, as the child grows. Forward facing only safety seats are installed in the vehicle with either the lap and shoulder belts or the LATCH system. **Note:** The top tether should be used in conjunction with the lap and shoulder belts.

The majority of forward facing only safety seats convert to belt-positioning booster safety seats by removing the internal harness after the child reaches 40 pounds. Because different child seats have different design characteristics, it is important to check the owner’s manual for slight usage variations.

Shield booster seats are considered forward facing only safety seats when the shield is used. Otherwise, they are considered booster safety seats.



**CRS equipped with internal harness and adjustable chest retainer clip**



**Shield booster seat**

**Booster Safety Seat (BSS)**

Booster safety seats elevate and position the child and they are intended to be used in a forward-facing orientation with the vehicle's lap and shoulder restraint. There are two main types of booster seats: belt-positioning high-back booster seats and backless booster seats. Many booster seats are hybrid models equipped with detachable seat backs.

Belt-positioning high-back booster seats typically contain shoulder belt channels/positioners (circled in images) that guide the shoulder belt in the proper orientation around the child and the CRS. The head restraint area of the high-back is usually contoured in a half-moon configuration to provide added protection for the child's head.



**Belt positioning high back(ed) booster seat**

Backless booster seats have no seat back, but they also contain belt channels/positioners under the armrests for correct belt routing. Some backless booster seats are equipped with a shield (the aforementioned shield-boosters) that is removable. Child seats are considered booster seats only if the shield is not used during the crash. Otherwise, they are considered forward facing safety seats.



**Backless booster seat**

The detachable seat back booster seat is a hybrid version of those illustrated in to the right and can be used in either manner. The latest variations of these booster seats include lower anchor LATCH anchors (outlined in image) that were uncommon to booster safety seats until 2008. The seat to the right is a LATCH equipped booster seat, widely considered the first of these new types of booster seats. The subject of LATCH is discussed in greater detail later in this (Child Restraint) section of the manual.



**LATCH equipped booster seat**

**Integrated Child Safety Seat (INT)**

Integrated child safety seats (also known as built-in child seats) are usually mounted within the seatbacks in the back rows of certain vehicles. The majority of the older models were designed for forward-facing orientation usage only for children of at least one year of age, a height of 33 – 40 inches, and a weight of 20 – 40 pounds. Most integrated seats were equipped with a 5-point internal harness system; however, many newer vehicles are equipping their vehicles with integrated booster seats for use by children who weigh up to 80 pounds. Many of the forward facing platforms are being phased out as manufacturers focus on a new generation of booster seats. The newer seats come in many different designs and it is important to check the owner’s manual for specific requirements for each integrated child restraint.



**Older 5-point harness type of integrated CRS (typically seen in many older minivans)**



**Newer booster type of integrated CRS**



**Newer booster type of integrated CRS**

**Harness (HSS)**

Harnesses are intended to be used on children in a forward facing orientation who exceed the weight and age restrictions of forward facing child seats (over 40 pounds/exceeding 5-years-old). Harnesses are comprised of two straps, connected by a chest retainer clip, that converge into one strap which is designed to affix to the top tether hook of the vehicle. The bottom edges of the straps contain loops near the seat bight for the lap belt to be routed through. The lap belt webbing rests against the child’s lap securing the lower body while the straps attach to the top tether hook and protect the torso. Although harnesses are compliant with FMVSS guidelines, they have largely been supplanted by booster seats, and are currently produced by only one manufacturer (EZ-On Products). They are rated to restrain children up to 80 pounds; however, with the installation of an aftermarket tether kit, the harness can restrain children up to 168 pounds.



**Harness**

**Travel Vests (VSS)**

Vests are designed for forward facing use only and are generally intended for use by children weighing 25 – 40 pounds. There are models that can accommodate persons from 2 years of age through adulthood and up to 168 pounds, but they are rare. Vests are comprised of similar adjustable harnesses and loops to be used in conjunction with the vehicle’s lap or lap and shoulder belt and top tethers. Some vests are designed with a 5-point internal harness and zipper activated adjustors to regulate the strap length. Some vests such as those used on special-needs school buses may require a separate aftermarket seat mount to ensure proper usage.



**Travel vest**

**Special Needs Safety Seat (SNSS)**

Special Needs seats are intended for children with special transportation needs who range from newborn to 100 pounds. The majority of these seats are designed for forward facing use only; however, some can be used in both forward and rear facing orientations. All SNSS's are configured with 3- or 5-point internal harness systems or some other internal harness configuration. Some are also equipped with belt extenders to be used in coordination with other aftermarket special needs products. These seats are usually much larger than standard forward facing child restraints.



**Special needs safety seat**

**Other, specify** (Not meant for vehicle travel)

Other child seats include all other items a person might use that are not FMVSS 213 or 225 compliant. These products may consist of seats with no labeling identifiable either through post-1990 child seat listings, manufacturer's instructions, or located within the typical literature on the subject. Persons have been known to use infant carriers, phone or other books, restaurant/home style booster seats, portable cribs/cradles, wood and plastic platforms and cushions and pillows. All of these examples would fall into the category of Other.

**Unknown**

Unknown is used when any child restraint cannot be identified. Before defaulting to this attribute all available information should be thoroughly examined (photographs, PAR statements, interview statements, CRS manuals) in an attempt to determine the CRS make, model, and type.

**DATE OF MANUFACTURE**

**Screen Name:** Date of Manufacture

**SAS Data Set:** *CHILDSEAT*

**SAS Variable:** *MANDATE*

**Oracle Name:** *CHILDSEAT.DATEMADE*

**Element Attributes:**

Oracle SAS

MM/DD/YYYY

Indicate the date of manufacture as indicated on the child restraint

12/30/1899 99/99/9999 Unknown date

**Source:** Vehicle inspection, child restraint system inspection, interview

**Remarks:**

Indicate the manufacture date as labeled on the child restraint. This information is important in determining the model of the child restraint when it is not otherwise known. The image on the left displays the expiration date of the child restraint (**2005**) and the image on the right displays the date of manufacture (**04MAR97**), as well as the model number (**235210P2**).



**MODEL NUMBER**

**Screen Name:** Model No

**SAS Data Set:** *CHILDSEAT*

**SAS Variable:** *MODELNO*

**Oracle Name:** *CHILDSEAT.MODELNO*

**Element Attributes:**

Indicate the model number as indicated on the child restraint

**Source:** Vehicle inspection, child restraint system inspection, interview

**Remarks:**

Refer to the image on the previous page for the model number. The model number will default to capital letters.

**SOURCE OF DATA**

**Screen Name:** Source of Data

**SAS Data Set:**

**SAS Variable:**

**Oracle Name:** *CHILDSEAT.SOURCEID*

**Element Attributes:**

Oracle	SAS	
1	1	Vehicle
2	2	Interview
3	3	Vehicle and Inspection
4	4	Photographs Only
5	5	Official Records

**Source:** Researcher determined

**Remarks:**

Indicate the source of the data for the child restraint information. If the CRS is present within the vehicle at the time of the inspection, use **Vehicle Inspection**. If the CRS is inspected at the owner/driver's home, use **Interview**. If the CRS is inspected and no vehicle inspection is obtained, use **CRS Inspection Only**. Official records include medical records and police reports.



**CHILD RESTRAINT USAGE ORIENTATION**

**Screen Name:** Orientation

**SAS Data Set:** *CHILDSEAT*

**SAS Variable:** *ORIENT*

**Oracle Name:** *CHILDSEAT.PICKORIENTATION*

**Element Attributes:**

Oracle	SAS	
1	1	Rear facing
2	2	Forward facing
3	3	Supine
-9998	8	Other (specify)
-9999	9	Unknown

**Source:** Vehicle inspection, Child Seat inspection, Interview

**Remarks:**

Indicate the orientation of the child restraint. If the CRS is present within the vehicle at the time of the inspection, use **Vehicle Inspection**. If the CRS is inspected at the owner/driver's home, use **Interview**. If the CRS is inspected and no vehicle inspection is obtained, use **CRS Inspection Only**. Official records include medical records and police reports.

**CHILD RESTRAINT HARNESS/SHIELD DESIGN**

**Screen Name:** Harness/Shield  
**SAS Data Set:** *CHILDSEAT*  
**SAS Variable:** *HARDES*  
**Oracle Name:** *CHILDSEAT.PICKHARNESSEDESIGN*

**Element Attributes:**

Oracle	SAS	
-8887	0	No harness/shield available
1	1	3-pt harness
2	2	5-pt harness
3	3	T-shield
4	4	Tray-shield
5	5	Shield
6	6	6-pt harness
-9999	9	Unknown

**Source:** Vehicle inspection, child restraint system inspection, interview

**Remarks:**

This variable explains how the CRS is designed to be used. It does not specify how the CRS was actually used in the crash, or whether it was used as designed.

A harness is similar to a normal safety belt, but it is integrated within the CRS itself. It is designed to restrain the child within the CRS.

Specific examples of harness and shield designs are discussed on the following pages.

**3-Point Harness**

Two harness straps that cross the child's shoulders are attached to a latch plate that is inserted into a buckle on the CRS. A retainer clip is also attached to the two harness straps to be positioned to the child's armpit level. These types of harnesses are found mostly in older ISS types and are not as common in recent years.



**3-point harness**

**5-Point Harness**

These are the most common types of harness straps found in all types of child restraints. The system consists of two straps that cross the shoulders and two straps that cross the child's thighs. A two-piece chest retainer clip connects the shoulder straps and dual latch plates are inserted into the buckle on the CRS.



**5-point harness**

**T-Shield**

The harness straps are housed within a T-shaped shield that is inserted into a buckle on the CRS. The harness straps are also connected by an adjustable chest retainer clip. This is another harness system that has been largely phased out and will only be found in older models.



**T-shield**

**Tray-Shield**

The harness straps are attached to a padded tray that folds down in front of the child's torso and hips. The latch plate is inserted into the buckle on the CRS and is sometimes attached to the tray-shield or is independent. This is another harness system that has been largely phased out and will only be found in older models.



**Tray-shield**

**Shield Booster**

Shield Boosters are attached to BSS-type restraints and have an internal path for belt routing. They are designed for children up to 60 pounds when the CRS is used as a BSS. This is another type of system that has been largely phased out.



**Shield booster**

**6-Point Harness**

The 6-point harness system is very rare for child restraints. The most common type of 6-point harness is illustrated to the right.



**6-point harness**

**CHILD RESTRAINT RETAINER CLIP**

**Screen Name:** Retainer Clip

**SAS Data Set:** *CHILDSEAT*

**SAS Variable:** *CLIPDES*

**Oracle Name:** *CHILDSEAT.RETAINERCLIPID*

**Element Attributes:**

Oracle	SAS	
0	0	No clip available
1	1	Clip available
-9999	9	Unknown

**Source:** Vehicle inspection , child restraint system inspection, interview

**Remarks:**

This variable explains how the CRS was designed to be used. It does not specify how the CRS was actually used in the crash, or whether it was used as designed.

A chest retainer clip is a plastic device which attaches the two harness straps. The retainer clip should be threaded correctly and positioned at the child’s armpit level. It is designed to keep the shoulder harnesses over the child’s shoulders during a crash. The images below illustrate the chest retainer clip.



**Retainer clip with 5-point harness**



**Retainer clip with T-shield**

**CHILD RESTRAINT TETHER DESIGN**

**Screen Name:** Tether

**SAS Data Set:** *CHILDSEAT*

**SAS Variable:** *TETHDES*

**Oracle Name:** *CHILDSEAT.PICKTETHERDESIGN*

**Element Attributes:**

Oracle	SAS	
0	0	No tether available or not designed with tether
1	1	Tether available
-9999	9	Unknown

**Source:** Vehicle inspection

**Remarks:**

This variable explains how the CRS was designed to be used. It does not specify how the CRS was actually used in the crash, or whether it was used as designed.

The Lower Anchors and Tethers for Children (LATCH) system is comprised of a top tether strap and lower anchor straps. This variable is coded if the CRS was equipped with a top tether strap that is used to secure the top of the CRS to the vehicle.



**LATCH system top tether attached**

**Screen Name:** LATCH  
**SAS Data Set:** CHILDSEAT  
**SAS Variable:** LATCHDES  
**Oracle Name:** CHILDSEAT.LATCHDESIGNID

**Element Attributes:**

Oracle	SAS	
0	0	No LATCH available or not designed with LATCH
2	1	LATCH available
-9999	9	Unknown

**Source:** Vehicle inspection, child restraint system inspection, interview

**Remarks:**

This variable explains how the CRS was designed to be used. It does not specify how the CRS was actually used in the crash, or whether it was used as designed.

All child restraints manufactured after September 1, 2002 will have two lower anchor attachments designed to connect to anchorage points inside the vehicle. The lower anchorage points are mounted within the second and third row seat bights and will secure the CRS to the seat independent of the vehicle's safety belts. The child restraints will also have belt paths for use of the safety belt, and the CRS can be secured using either system.



**LATCH Lower anchor attachments**



**Lower seat anchorage points within vehicle**

**Diagram of LATCH system**

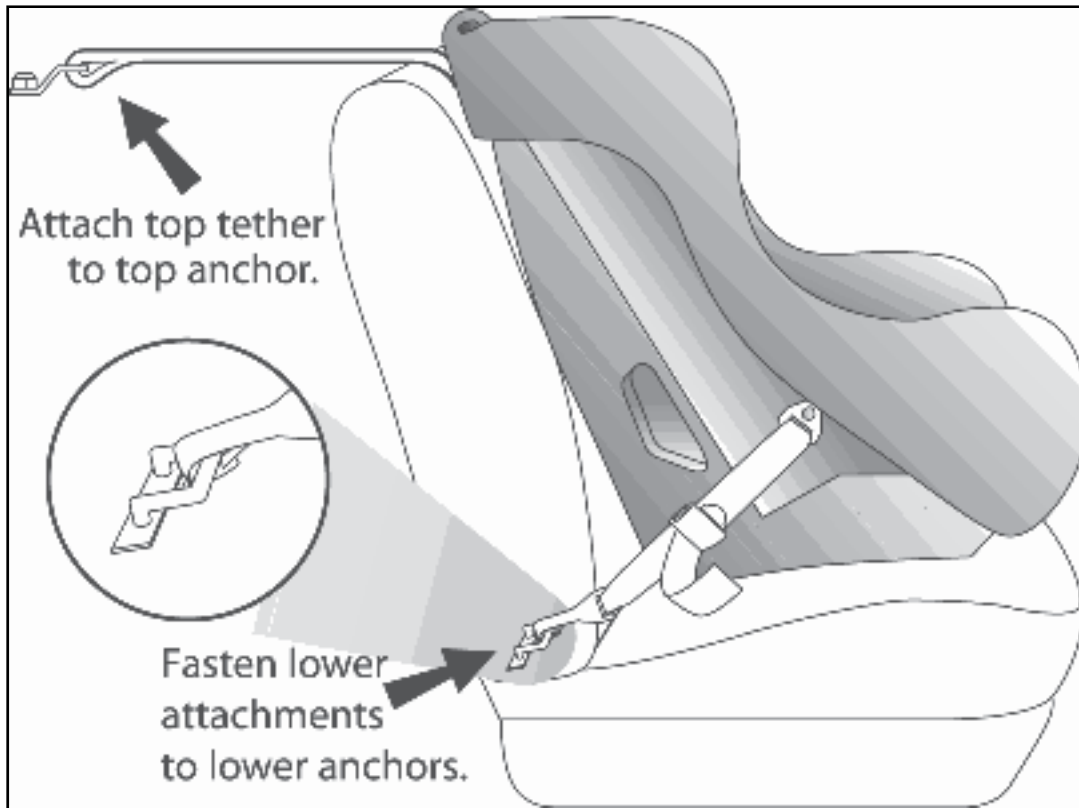



**CHILD RESTRAINT USAGE ORIENTATION**

**Screen Name:** Orientation

**SAS Data Set:** *CHILDSEAT*

**SAS Variable:** *ORIENT*

**Oracle Name:** *CHILDSEAT.PICKORIENTATION*

**Element Attributes:**

Oracle	SAS	
1	1	Rear facing
2	2	Forward facing
3	3	Supine
-9998	8	Other (specify)
-9999	9	Unknown

**Source:** Vehicle inspection, child restraint system inspection, interview

**Remarks:**

**Rear Facing**

The CRS was facing the rear of the vehicle at the time of the crash.

**Forward Facing**

The CRS was facing the front of the vehicle at the time of the crash.

**Supine**

The CRS was laying flat at the time of the crash.

**Other (specify)**

At the time of the crash the CRS was facing in another direction (i.e., sideways, on top, or underneath something).

**Unknown**

A CRS was present, but the orientation at the time of the crash cannot be determined.

## CHILD RESTRAINT HARNESS/SHIELD USE

Page 1 of 2

Screen Name: Harness/Shield

SAS Data Set: *CHILDSEAT*SAS Variable: *HARUSE*Oracle Name: *CHILDSEAT.PICKHARNESSUSAGE***Element Attributes:**

Oracle	SAS	
1	0	Not designed with a harness
2	1	Harness/shield not used
3	2	Harness straps in Top/Highest slot
4	3	Harness straps in the Middle slots
	4	Harness straps in Bottom/Lowest slots
5	5	Harness used – but slot used is unknown
6	6	Retrofitted with Harness
7	7	Shield used
8	9	Other (specify)
-9999	10	Unknown if harness/shield used

Source: Vehicle inspection, child restraint system inspection, interview

**Remarks:**

Make a determination of the harness/shield usage at the time of the crash.

**Not Designed with Harness**

This attribute is used if the CRS did not have an internal harness.

**Harness/Shield Not Used**

This attribute is used if the CRS had a harness/shield, but it was not used.

**Harness straps in Top/Highest slots**

This attribute is used if the harness straps were in the highest slots.

**Harness straps in Middle slots**

This attribute is used if the harness straps were in any one of the middle slots. **Note:** Some child restraints are equipped with five sets of slots. In these cases, use this code if the harness straps are routed through any of the middle slots.

**Harness straps in Bottom/Lowest slots**

This attribute is used if the harness straps were in the lowest slots.

**Harness Used, but slots used is unknown**

This attribute is used if the researcher was unable to determine what set of slots the harness straps were routed through.

**Retrofitted with Harness**

This attribute is used if the harness straps were replaced prior to the crash.

**Shield Used**

This attribute is used if the CRS was equipped with either a Tray or T-shield in lieu of an internal harness system.

**Other (specify)**

This attribute is used if the harness straps were routed unconventionally or through different slots. For example, if the right strap was routed through the top slot and the left slot was routed through a middle slot, this attribute would be selected. Whenever the harness strap usage is questionable, use this attribute and specify further.

**Unknown**

This attribute is used when the harness slot usage cannot be determined.

**CHILD RESTRAINT RETAINER CLIP USE**

**Screen Name:** Retainer Clip

**SAS Data Set:** *CHILDSEAT*

**SAS Variable:** *CLIPUSE*

**Oracle Name:** *CHILDSEAT.RETAINERCLIPUSEID*

**Element Attributes:**

Oracle	SAS	
1	0	Not designed with retainer clip
2	1	Retainer clip not used
3	2	Retainer clip used – neck level
4	3	Retainer clip used –chest/armpit level
5	4	Retainer clip used –stomach level
7	5	Retainer clip used – unknown level
6	6	Retrofitted with retainer clip
-9999	9	Unknown if retainer clip used

**Source:** Vehicle inspection, child restraint system inspection, interview

**Remarks:**

The actual CRS harness retainer clip use at the time of the crash must be determined and coded. The position of the retainer clip on the child is usually determined during the interview with the care giver.

**CHILD RESTRAINT TETHER USE****Screen Name:** Tether**SAS Data Set:** *CHILDSEAT***SAS Variable:** *TETHUSE***Oracle Name:** *CHILDSEAT.PICKTETHERUSAGE***Element Attributes:**

Oracle	SAS	
1	0	Not designed with tether
2	1	Tether not used
3	2	Tether used (original tether)
-9999	9	Unknown if tether Used

**Source:** Vehicle inspection, child restraint system inspection, interview**Remarks:**

If coded as used, the LATCH tether was anchored to the top tether hook in the vehicle.

**CHILD RESTRAINT LATCH ANCHOR HOOK USE****Screen Name:** LATCH**SAS Data Set:** *CHILDSEAT***SAS Variable:** *LATCHUSE***Oracle Name:** *CHILDSEAT.LATCHUSEID***Element Attributes:**

Oracle	SAS	
1	0	Not designed with LATCH anchor hooks
4	3	LATCH anchor hooks – not used
2	1	LATCH anchors hooks used
-9999	9	Unknown if LATCH anchors were used

**Source:** Vehicle inspection, child restraint system inspection, interview**Remarks:**

If coded as used, the LATCH anchor hooks were affixed to the lower anchors in the vehicle.

## CHILD RESTRAINT BELT ROUTING/USE

Page 1 of 2

Screen Name: Belt Routing/Use

SAS Data Set: CHILDSEAT

SAS Variable: BELTROUT

Oracle Name: CHILDSEAT.BELTROUTING

**Element Attributes:**

Oracle	SAS	
5	0	No belt routing
-9998	1	No belt used
1	2	Belt routed through belt positioning slots/channels
2	3	Belt routed through forward facing slots/channels
3	4	Belt routed through rear facing slots/channels
4	5	Belt routed unconventionally (specify)
-9999	9	Unknown belt path or if belt routed

Source: Vehicle inspection, child restraint system inspection, interview

**Remarks:****No belt routing**

The belt was not routed through any slots/channels in the CRS. The belt was used solely to restrain the child sitting in the CRS. This attribute is pre-coded for integral child restraints.

**No belt used**

No belt was used to either restrain the child or install the CRS.

**Belt routed through belt positioning slots/channels**

The belt was routed through the belt positioning slots built into the CRS.

**Belt routed through forward facing slots/channels**

The belt was routed through the forward facing slots or channels built into the CRS.

**Belt routed through rear facing slots/channels**

The belt was routed through the rear facing slots or channels built into the CRS.

**Belt routed unconventionally (specify)**

Any other type of unconventional belt routing.

**Unknown belt path or if belt routed**

It is not known what path the belt took around the CRS. If it is not known if the belt was used, indicate that in the safety belt section and choose this attribute for belt routing.



## USE OF LOCKING CLIP ON VEHICLE BELT

Page 1 of 2

Screen Name: Locking Clip Use

SAS Data Set: CHILDSEAT

SAS Variable: LOCKCLIP

Oracle Name: CHILDSEAT.LOCKINGCLIPID

**Element Attributes:**

Oracle	SAS	
1	0	None present
2	1	Locking clip used on lap and shoulder belt
3	2	Locking clip used on lap belt only
4	3	Locking clip used on shoulder belt only
5	8	Other (specify)
9	9	Unknown

Source: Vehicle Inspection, child restraint system inspection, interview

**Remarks:**

When a locking clip is found in a vehicle, photographs should be taken. This variable is not assessing the proper use of the locking clip, it is merely identifying where it is positioned on the belt.

A **locking clip** is usually included with the CRS at the time of purchase and is typically found on the back aspect of the CRS seatback. The purpose of a locking clip is to the lock belt systems of vehicles that contain sliding latch plates and emergency locking retractors only (e.g., vehicles that do not have automatic locking capability). Locking clips used on the lap and shoulder belt combination are to be positioned no more than one inch above the latch plate. Seat belts are usually labeled indicating the need of a locking clip and this need is also discussed in the vehicle owner's manual.

**None present**

When a locking clip was not used in the crash.

**Locking clip used on lap and shoulder belt**

When the lap and shoulder belts are threaded through as locking clip during the crash.

**Locking clip used on lap belt only**

When the lap belt is threaded through as locking clip during the crash.

**Locking clip used on shoulder belt only**

When the shoulder belt is threaded through as locking clip during the crash.

**Other (specify)**

When it is determined that a locking clip was used but not in a manner stated above. Specify how the locking clip was used.

**Unknown**

When locking clip usage cannot be determined.



**Locking clip affixed to belt webbing no more than 1 inch above latch plate**



**General instructions on how to position locking clip**



**Locking clip correctly positioned on belt webbing near sliding latch plate**



**Locking clip correctly positioned on belt webbing near sliding latch plate**

**Screen Name:** Seat Location

**SAS Data Set:** *CHILDSEAT*

**SAS Variable:** *SEATPOS*

**Oracle Name:** *SEATLOC.SEATROW and SEATLOCATION*

**Element Attributes:** Seat Number

***Front Row***

11 Left side  
12 Middle  
13 Right side

***Third Row***

31 Left side  
32 Middle  
33 Right side  
34 Other (specify)

***Second Row***

21 Left side  
22 Middle  
23 Right side  
24 Other (specify)

***Fourth Row***

41 Left side  
42 Middle  
43 Right side  
44 Other (specify)

***Fifth Row***

51 Left side  
52 Middle  
53 Right side  
54 Other (specify)

***Other Rows***

Cargo Area  
Unknown

**Source:** Vehicle Inspection, child restraint system inspection, interview

**Remarks:**

All child restraints found inside the vehicles are to be coded into EDS. This includes unoccupied child restraints. This variable assigns a seating location for each CRS. For example, if a vehicle has child restraints present in the second row center and the third row right positions, 22 and 33 should be selected.

There are cases where a child is sitting within a CRS but is not restrained with the lap and shoulder belts or the internal harness. The CRS will still be coded as used and the variables within the CRS section will be coded to reflect the child's unbelted status.

The majority of child restraints are taken from the vehicle either during the removal of the child from the vehicle post-crash or by an occupant/family member after the crash. These restraints can usually be inspected at the home of the interviewee or at the attending hospitals. However, on some occasions the child restraints are discarded prior to the case assignment. In those cases, some details about the CRS can be ascertained during the interview, by on-scene photographs, and by the interior vehicle inspection.

In all cases involving a CRS, it is imperative that the interview is obtained. To properly understand how the CRS was used and how it performed during the crash, the height, weight, and other supportive information about the child is needed. Moreover, to truly understand the experience of the person who was installed the CRS, a direct interview with that individual is vital.

**CHILD RESTRAINT PLACEMENT**

**Screen Name:** Placement

**SAS Data Set:** *CHILDSEAT*

**SAS Variable:** *PLCMNT*

**Oracle Name:** *CHILDSEAT.PLACEMENTID*

**Element Attributes:**

Oracle	SAS	
1	1	Seat
2	2	Floor
3	3	Lap of other occupant
4	4	Console
-9998	8	Other (specify)
-9999	9	Unknown

**Source:** Vehicle inspection, child restraint system inspection, interview

**Remarks:****Seat**

CRS placed on vehicle seat.

**Floor**

CRS placed on vehicle floor.

**Lap of Occupant**

CRS placed on lap of another occupant.

**Console**

CRS placed on console.

**Other (specify)**

Other position of CRS (specify).

**Unknown**

Position of CRS could not be determined.

**CHILD POSITION IN CHILD RESTRAINT**

**Screen Name:** Child Position

**SAS Data Set:** *CHILDSEAT*

**SAS Variable:** *POSTN*

**Oracle Name:** *CHILDSEAT.POSTUREINUSEID*

**Element Attributes:**

Oracle	SAS	
-9997	0	[Not occupied]
1	1	Upright
2	2	Reclined/lying back
3	3	Supine, facing upwards
4	4	Slumped forward
5	5	Slumped to the side
6	6	Kneeling
-9998	8	Other (specify)
-9999	9	Unknown

**Source:** Interview

**Remarks:**

**[Not Occupied]**  
Pre-coded

**Upright**  
Child was sitting upright, facing forward.

**Reclined/Lying Back**  
Child was reclined, between 90 and 45 degrees.

**Supine**  
Child was lying flat, facing upward.

**Slumped Forward**  
Child was leaning.

**Slumped to the Side**  
Child was leaning to the side from the waist up and their back was not against the back of the child restraint or vehicle, in case of a backless booster seat.

Child Position (cont'd)

Page 2 of 2

**Kneeling**

Child was kneeling while in the CRS.

**Other (specify)**

Any other position of the child that can be determined.

**Unknown**

Unknown position of the child in the CRS.

**VEHICLE**

Safety Systems Form, Case 2007-996-900015/ Vehicle #1

SEAT | RESTRAINTS | AIR BAG | CHILD SEAT | LOG | REVIEW

LIST | DETAIL

CHILD SEAT | VEHICLE

Belt Retractor Type

Latch Plate Type

Latch Anchor

Latch Tether

Save



**BELT RETRACTOR TYPE**

Page 1 of 2

**Screen Name:** Belt Retractor**SAS Data Set:** SEATLOC**SAS Variable:** ACTBLRET**Oracle Name:** MANUALEATBELT.RETRACTORTYPEID**Element Attributes:**

Oracle	SAS	
3	0	None Present
2	1	Emergency Locking Retractor
7	2	Automatic Locking Retractor
4	3	Switchable Retractor in ELR Mode
5	4	Switchable Retractor in ALR Mode
6	5	Switchable Retractor in Unknown Mode
9	9	Unknown Type of Retractor

**Source:** Vehicle Inspection, interview**Remarks:**

This variable is coded for all manual seat belts that are coded for any vehicle position.

If a sewn on latch plate is present, there will most likely be a retractor for both the shoulder portion and the lap portion of the belt. Most likely the shoulder portion will be an ELR and the lap portion will be switchable from ELR to ALR. In this variable we are only interested in the retractor of the lap portion of the belt.

Another type of switchable retractor switches when the belt is pulled all the way out causing the retractor to switch to ALR mode.

Retractors wind up the loose webbing of the unused 3-point safety belt, take up the slack, and provides slight tension on belts that are in use. They are usually located out of sight at an anchor point. Check the vehicle owner's manual and also look for labels on the belt webbing to determine the retractor type.

**NOTE** that some newer vehicles have a switchable retractor that can be manually adjusted from ELR to ALR. Most of them can be switched by pulling the webbing all the way out of the retractor to activate the ALR. In some models, the retractors switch from ELR to ALR with the push of a button. Most switchable retractors have a label on the belt with instructions on how to switch it. Enter the information for the position of the retractor.

**Automatic locking retractor (ALR)**

The ALR locks in place after being pulled out and allowed to retract about ½" The belt cannot be extended unless it is first fully rewound. It is generally uncomfortable for adults to wear.

**Emergency locking retractor (ELR)**

The ELR allows the belt to be freely extended or rewound. It locks only when the vehicle slows, changes direction, or stops suddenly. Since the retractor rarely locks during normal driving, it provides more freedom and comfort to an adult driver than an ALR. Some ELRs are vehicle sensitive and lock in direct response to the deceleration of the vehicle. Other ELRs are webbing or belt-sensitive and temporarily lock in response to a quick jerk or pull on the belt. Some ELRs are both vehicle and belt sensitive. Some ELRs have a window shade tension reliever system designed to make 3-point belts more comfortable by allowing "slack" in the shoulder belt. Occupants using these belts "tug" on the shoulder belt to tighten it after they lean forward.

**Unknown**

is used when the type of retractor cannot be determined.

**LATCH PLATE TYPE**

Page 1 of 2

**Screen Name:** Latch Plate**SAS Data Set:** SEATLOC**SAS Variable:** ACTLPLAT**Oracle Name:** MANUALEATBELT.LATCHTYPEID**Element Attributes:**

Oracle	SAS	
8	0	Not used/not available
1	1	Sliding
2	2	Light weight locking/cinching
3	3	Locking
4	4	Switchable
5	5	Sewn On
6	9	Unknown Type

**Source:** Vehicle Inspection**Remarks:**

This variable is coded for all manual seat belts that are coded for any vehicle position.

**Sliding**

The webbing is threaded through a slot in the latch plate and there is no locking bar. The latch plate slides freely along the webbing, regardless of the angle. Allows the webbing to slip through unrestricted.

**Locking**

The webbing threads through a locking bar or an adjuster in the latch plate. Once it is tightened, the belt will not loosen until the plate is tilted and the belt is unbuckled.

**Lightweight locking/cinching**

The same as locking but with more moving parts. As long as the plate is parallel with the webbing the latch plate is locked.

**Switchable**

Switchable has a switch that locks the belt webbing by sliding a button.

**Sewn on**

If a sewn on latch plate is present, there will be a retractor for both the shoulder portion and the lap portion of the belt. Most likely the shoulder portion will be an ELR and the lap portion will be switchable.

**Unknown type**

is used when the type of latch plate is not determined.



Sliding



Sliding



Lightweight locking/cinching



Lightweight locking/cinching



Locking



Locking



Switchable



Switchable



Sewn on



Sewn on

**LATCH LOWER ANCHOR AVAILABILITY****Screen Name:** LATCH Anchor**SAS Data Set:** SEATLOC**SAS Variable:** LATANCH**Oracle Name:** SEATLOC.LATCHANCHORID**Element Attributes:**

Oracle	SAS	
1	0	No
2	1	Yes
3	9	Unknown if anchor

**Source:** Interior Vehicle Inspection (and/or Interview)**Remarks:**

Currently, some new passenger vehicles are equipped with lower child seat anchorage points between a vehicle's seat cushion and seat back. Together, the two lower anchorage points and top tether anchorage make the Lower Anchor and Tether for Children (LATCH) system. Since 2002, this system is required in two rear seating positions of all cars, minivans, and light trucks.

A lower anchorage is a small rod or bar located between a vehicle's seat cushion and seat back allowing a child safety seat to be attached or snapped into the vehicle instead of being held secure by the vehicle's belt system. By September 1, 2002, all child safety seats will have two attachments which will connect to the vehicle's lower anchorage attachment points. (Some child seat manufacturers have included lower anchorage points in year 2000 models.)

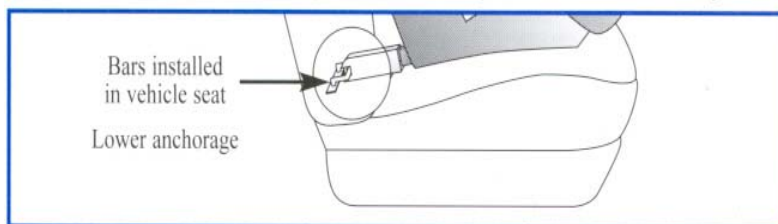

**LATCH TETHER AVAILABILITY**

**Screen Name:** LATCH Tether

**SAS Data Set:** SEATLOC

**SAS Variable:** LATTETH

**Oracle Name:** SEATLOC.LATCHANCHORID

**Element Attributes:**

Oracle	SAS	
1	0	No
2	1	Yes
3	9	Unknown if tether

**Source:** Interior Vehicle Inspection (and/or Interview)

**Remarks:**

In some vehicles, such as mini-vans and station wagons, the tether anchor may be found on the rear floor of the vehicle, on the back of the rear seat, and on the roof area. It may be concealed by some sort of covering which can be removed or “flipped up”.

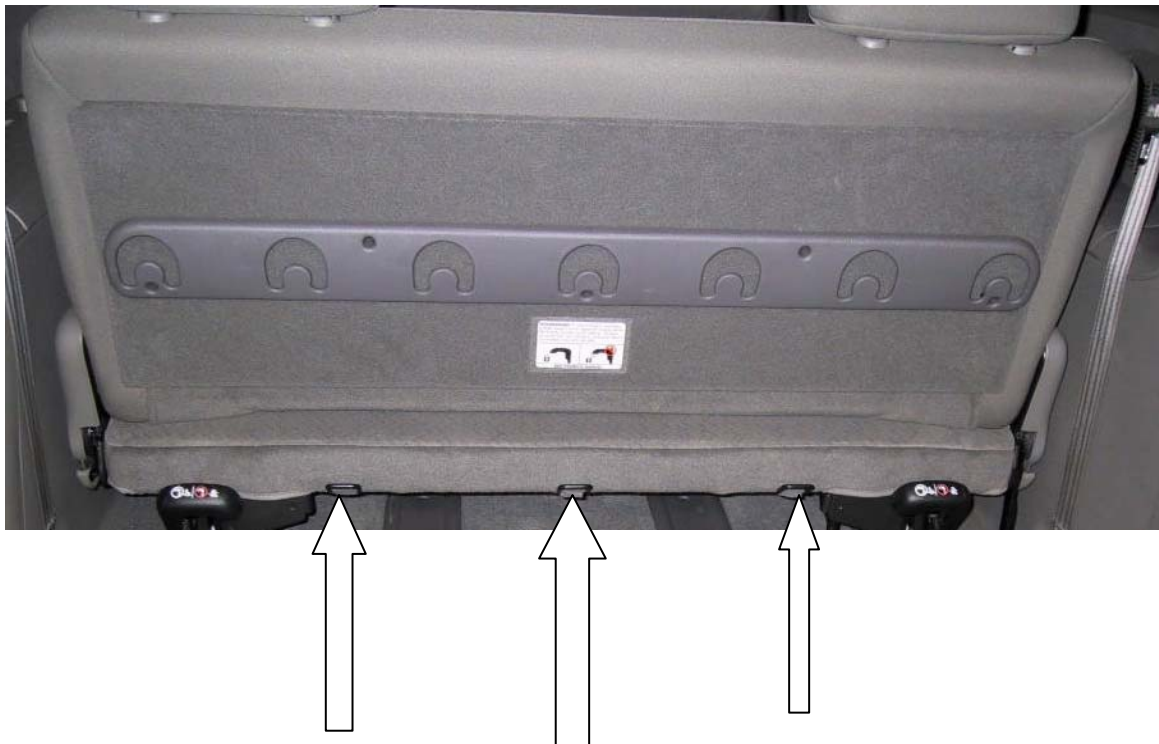

**LOG**

Safety Systems Form, Case 2007-996-900015/ Vehicle #1

SEAT | RESTRAINTS | AIR BAG | CHILD SEAT | LOG | REVIEW

**Documentation of**

Seat Belt

Air Bag

Seats

**Quality of Interior Slides**

Subject  Slides

 Save

**PSU REVIEW**

Safety Systems Form, Case 2007-996-900015/ Vehicle #1

SEAT | RESTRAINTS | AIR BAG | CHILD SEAT | LOG | REVIEW

PSU REVIEW | ZONE REVIEW

LIST | DETAIL

Form  Tab  Veh#  Occ#

Original  Suggested

Comment



**ZONE REVIEW**

Safety Systems Form, Case 2007-996-900015/ Vehicle #1

SEAT | RESTRAINTS | AIR BAG | CHILD SEAT | LOG | REVIEW

PSU REVIEW | ZONE REVIEW

LIST | DETAIL

Form  Tab  Veh #  Occ #

Original  Final

Reason  Change

Comment

OCCUPANT

Occupant Form, Case #2009-903-95732S/Vehicle # 1/Occupant #1

OCCUPANT | EJECTION | ENTRAPMENT | SEAT | AIR BAG | CHILD SEAT | SEAT BELT | INJURY | INJURY CODES | REVIEW | LOG

Number

Age  years

Height  cm.

Weight  kg.

Sex

Fetal mortality

Role

Race

Ethnicity

Eye Wear

Child Seat Used

**Police Reported**

Belt Use

Air Bag Avail/Function

PAR Severity

---

### Occupant Overview

This section provides a base of information that is vital to the analytical process. Ergonomic engineers design the interior of vehicles to be most comfortable for a range of occupants. The height and weight for a particular age bracket are considered in establishing the leg room, head room, and other interior dimensions for a vehicle. Restraint design relies heavily on this type of information. Initial designs of active belts were determined to be very uncomfortable and difficult to wear. The use of a wider range of heights and weights, which also has a bearing on seat adjustments, resulted in belts which were much more comfortable to wear and therefore encouraged use.

Occupant demographics and position play an important role in the injury mechanism, restraint system effectiveness, and vehicle design analysis. For example, the vehicle design, which includes the restraint system, must take into consideration the differences between a 163 centimeters, 45 kilograms driver and a 198 centimeters, 136 kilograms passenger. Both of these occupants must be provided with the same amount of protection by the vehicle in a crash.

Societal costs are also derived from these variables and the related injury assessment variables in this and the Occupant Injury Form.

In many cases the only source for this information is the interview. For this reason the researcher should ask probing questions to elicit complete and accurate responses to these, and all other, variables.

Federal Motor Vehicle Safety Standards--FMVSS 202 (Head Restraints), FMVSS 206 (Door Locks and Door Retention Components), FMVSS 207 (Seating Systems), FMVSS 208 (Occupant Protection), FMVSS 212 (Windshield Mountings), FMVSS 213 (Child Restraint System), FMVSS 214 (Side Door Strength), and FMVSS 216 (Roof Structure) are all assessed relative to their potential for reduction of injury to occupants. For this reason it is necessary to have the occupant's characteristics as complete as possible for correct and accurate assessment of the various vehicle components and FMVSSs which apply.

The Occupant Form is also where the Researcher makes their final determination of certain data that is collected from different sources within the case. For example, the Interviewee may say they were wearing the seatbelt; the interior vehicle inspection may indicate that no belt was in use at the time of the crash, as recorded in the Safety Systems Form; the medical report **may not** indicate either way. The researcher must then make their final decision, based on all available evidence, whether or not the seatbelt was worn on the Seatbelt Tab of this form.

**OCCUPANT NUMBER**

**Screen Name:** Number

**SAS Data Set:** *OA*

**SAS Variable:** *OCCNO*

**Oracle Name:** *OCCUPANT.OCCUPANTNUMBER*

**Element Attributes:**

Pre-assigned

**Source:** User assigned on Case Form

**Remarks:**

Occupants for this vehicle must be added into the case structure on the Case Form, Structure tab, Occupant sub-tab.

1. Occupant numbers must be assigned sequentially, beginning in the passenger compartment area with "1". No numbers may be skipped. Assign numbers left to right and front to back among occupants.
2. Assign numbers last to persons on the vehicle or in an unenclosed area. Persons appended to vehicle for motion (*e.g.*, bicyclist holding onto vehicle) are either pedestrians or other nonmotorists and not occupants; therefore, no form is completed, and no number is assigned.
3. For seating locations where more than one occupant occupies the seat, begin numbering the occupant seated in the seat first. For each additional occupant in the lap or lying across, assign one number higher. If an occupant is on the floor in front of a person(s) assign one number higher.
4. Occupants sharing a seating position should be assigned numbers using the guidelines stated in item #3.

**OCCUPANT'S AGE**

**Screen Name:** Age  
**SAS Data Set:** OA  
**SAS Variable:** AGEMONTH, AGEYEAR  
**Oracle Name:** OCCUPANT.AGE, DERIVED

**Element Attributes:**

Oracle SAS  
Enter actual age in months if under 2 years, in years or months if older than 2 years.  
-9999 99/999 Unknown

**Range:** AGEMONTH:  
1-24, 36, 48 (multiples of 12 up to 1440) 9999  
AGEYEAR:  
999

**Source:** Primary source is interviewee; secondary sources include police reports and other official records (*i.e.*, medical records).

**Remarks:**

The occupant's age at the time of the crash is recorded with respect to the occupant's last birthday.

If under the age of two years enter the actual age in months. If less than one month old enter one month.

If you are unable to obtain the age of a driver, request a driver's license record. **This action must be discussed with your zone center and COTR. Licensing file data takes precedence over police or interview data.**

**AGEMONTH** contains the age of the people two years and under and is expressed in months.  
**AGEYEAR** contains the age of the people two years and older and is expressed in years.

**OCCUPANT'S HEIGHT****Screen Name:** Height**SAS Data Set:** OA**SAS Variable:** *HEIGHT***Oracle Name:** *OCCUPANT.HEIGHT***Element Attributes:**

Oracle SAS

-9999	999	Entry defaults to inches, but may also be entered in centimeters
		Unknown

**Range:** 30 – 220+, 999 cms**Source:** Researcher determined--inputs include interviewee or official records (*e.g.*, medical).**Remarks:**

Enter actual height to nearest inch/centimeter (program automatically converts inches to centimeters). If the height is greater than 220 cms code as 220 cms and annotate the actual height.

The PAR may be used as a source if it contains this data, but it is superseded if other data exists.

Autopsies often include this information; use it when present.

If you are unable to obtain the height of a driver, request a driver's license record. **This action must be discussed and a policy determined with your zone center and COTR. Licensing file data takes precedence over police or interview data. If other sources are found to be more reliable, use that source and annotate.**

**OCCUPANT'S WEIGHT**

**Screen Name:** Weight  
**SAS Data Set:** OA  
**SAS Variable:** *WEIGHT*  
**Oracle Name:** *OCCUPANT.WEIGHT*

**Element Attributes:**

Oracle SAS  
-9999 9999 Entry defaults to pounds, but may also be entered in kilograms.  
Unknown

**Range:** 2 – 275+ kgs, 999

**Source:** Researcher determined--inputs include interviewee or official records (*e.g.*, medical).

**Remarks:**

Enter actual weight to nearest pound/kilogram. **The appropriate units must be selected for the English or Metric system.** If the weight is greater than 275 kgs code as 275 kgs and annotate the actual weight.

The PAR may be used as a source if it contains this data, but it is superseded if other data exists.

Autopsies often include this information; use it when present.

## OCCUPANT'S SEX

Page 1 of 2

**Screen Name:** Sex  
**SAS Data Set:** OA  
**SAS Variable:** SEX  
**Oracle Name:** OCCUPANT.SEX

**Element Attributes:**

Oracle	SAS	
1	1	Male
2	2	Female
3	3	Female — pregnant - 1st trimester (1st-3rd month)
4	4	Female — pregnant - 2nd trimester (4th-6th month)
5	5	Female — pregnant - 3rd trimester (7th-9th month)
6	6	Female — pregnant - trimester unknown
9	9	Unknown

**Source:** Primary source is the interview, secondary sources include police report and official records (*e.g.* medical).

**Remarks:****Male****Female**

This includes any females for whom pregnancy status is unknown.

**Female — pregnant - 1st trimester (1st-3rd month)**

consists of women and girls who are reported to be pregnant and were in the first three months of their pregnancy at the time of the crash.

**Female — pregnant - 2nd trimester (4th-6th month)**

consists of women and girls who were reported to be pregnant and were in the second three months of their pregnancy at the time of the crash.

**Female — pregnant - 3rd trimester (7th-9th+ month)**

consists of women and girls who were reported to be pregnant and were in the final third of their pregnancy at the time of the crash. Pregnant females who were over nine months pregnant are also included.



**Female — pregnant - trimester unknown**

consists of women and girls who were reported to be pregnant at the time of the crash but the stage of their pregnancy could not be determined.

**Unknown**

is used when the sex of the occupant cannot be determined.

**WAS THERE ANY INDICATION THAT THIS PREGNANT OCCUPANT LOST THE FETUS?**

**Screen Name:** Fetal Mortality

**SAS Data Set:**

**SAS Variable:**

**Oracle Name:** *OCCUPANT.FETALMORTALITY*

**Element Attributes:**

Oracle	SAS	
2	2	No
1	1	Yes
	8	[Not Applicable]

**Source:** Primary source is the interview, secondary sources include police report and official records (*e.g.* medical records and autopsy reports).

**Remarks:**

A fetal fatality is indicated when fetal death occurs within 30 days of the crash. The death must have occurred as a consequence of the crash.

**No**

No is used for a no response during the interview and when not reported. If the researcher determines that it is unknown if there was a fetal fatality then the correct response is No.

**Yes**

is used when a fetal death occurs with 30 days of the crash and as result of the crash.

**N/A**

Is a prefill when Sex is not equal to a pregnant female.

**OCCUPANT'S ROLE**

**Screen Name:** Role

**SAS Data Set:** *OA*

**SAS Variable:** *ROLE*

**Oracle Name:** *OCCUPANT.PICKROLE*

**Element Attributes:**

Oracle	SAS	
1	1	Driver
2	2	Passenger
9	9	Unknown

**Source:** Primary source is interviewee; secondary source is other official records.

**Remarks:**

Hit-and-run vehicles are assumed to have only one occupant (unless reliable evidence to the contrary exists), and that person is assumed to be the driver. A driver is an occupant who is in actual physical control of the vehicle. All other persons riding in or on the vehicle are considered to be passengers.

## RACE

Page 1 of 2

**Screen Name:** Driver Race

**SAS Data Set:** *GV*

**SAS Variable:** *D\_RACE*

**Oracle Name:** *OCCUPANT.RACE*

**Element Attributes:**

Oracle	SAS	
1	1	White
2	2	Black or African American
3	3	Asian
4	4	Native Hawaiian or Other Pacific Islander
5	5	American Indian or Alaska Native
7	7	Other (specify):
8	8	[No driver present]
-9999	9	Unknown

**Source:** Researcher determined; primary source is the interviewee; secondary sources include police report, medical records, and other official documents.

**Remarks:**

**Note:** Although this variable is on the **Official Records Tab**, this variable is a “self identification” by the occupant. This information can be obtained from any of the above sources, however is not always an “official record”. When using secondary sources, the Race must be specifically mentioned in the document.

The concept of race as used by the U.S. Census Bureau reflects self-identification; it does not denote any clear-cut scientific definition of biological stock. Self-identification represents self-classification by people according to the race with which they identify themselves. For drivers with parents of different races who cannot provide a single response, use the race of the driver's mother; however, if a single response cannot be provided for the driver's mother, the first race reported by the driver is encoded.

**Prioritization of data sources:**

**First, use interviewee data.** Ask the interviewee what the driver considers their race to be. If the response does not clearly fit into one of the race categories, then use the information provided by the interviewee concerning the driver's nationality to select the correct element value.

**Second, use the PAR.** If race is given on the PAR and the PAR scheme is compatible with this variable, then use the PAR information.

In addition, the driver's *name* is not a reliable indicator of race and **cannot be used** when selecting the applicable element value for this variable.

**Third, use official records (e.g., medical).** If the data needed cannot be obtained from the interviewee and is not available or usable from the PAR, then use official records, if available, to determine the correct element attribute.

### **Element Attributes**

#### **White**

is selected for drivers who consider themselves a person having origins in any of the original peoples of Europe, the Middle East or North Africa.

#### **Black or African American**

is for drivers who consider themselves a person having origins in any of the black racial groups of Africa. Terms such as "Haitian" or "Negro" can be used in addition to "Black or African American."

#### **Asian**

is selected for drivers who consider themselves a person having origins in any of the original peoples of the Far East, Southeast Asia, or the Indian subcontinent including, for example, Cambodia, China, India, Japan, Korea, Malaysia, Pakistan, the Philippine Islands, Thailand and Vietnam.

#### **Native Hawaiian or Other Pacific Islander**

is selected for drivers who consider themselves a person having origins in any of the original peoples of Hawaii, Guam, Samoa, or other Pacific Islands.

#### **American Indian or Alaska Native**

is selected for drivers who consider themselves a person having origins in any of the original peoples of North and South America (including Central America), and who maintains tribal affiliation or community attachment.

#### **Other**

is selected for drivers who consider themselves to be of a race not described above. Use this attribute for descriptions such as: Eurasian, Cosmopolitan, inter-racial, etc

#### **Unknown**

is selected when the source(s) available do not provide sufficient information to classify the driver's race.

## ETHNICITY

Page 1 of 2

**Screen Name:** Driver Ethnicity

**SAS Data Set:** *GV*

**SAS Variable:** *D\_ETHNIC*

**Oracle Name:** *OCCUPANT.ETHNICITY*

**Element Attributes:**

Oracle	SAS	
1	1	Hispanic or Latino
2	2	Not Hispanic or Latino
8	8	[No driver present]
-9999	9	Unknown

**Source:** Researcher determined; primary source is the interviewee; secondary sources include police report, medical records, and other official documents.

**Remarks:**

**Note:** Although this variable is on the **Official Records Tab**, this variable is a “self identification” by the occupant. This information can be obtained from any of the above sources, however it is not always an “official record”. When using secondary sources, the ethnicity must be specifically mentioned in the document.

The concept of ethnicity as used by the U.S. Census Bureau reflects self-identification; it does not denote any clear-cut scientific definition of biological stock. Self-identification represents self-classification by people according to the ethnicity with which they identify themselves. For drivers with parents of different ethnicity who cannot provide a single response, use the ethnicity of the driver's mother; however, if a single response cannot be provided for the driver's mother, the first ethnicity reported by the driver is encoded.

**Prioritization of data sources:**

**First, use interviewee data.** Ask the interviewee what the driver considers their ethnicity to be. If the response does not clearly fit into one of the ethnicity categories, then use the information provided by the interviewee concerning the driver's nationality/ethnic origin to select the correct element value.

**Second, use the PAR.** If ethnicity is given on the PAR and the PAR scheme is compatible with this variable, then use the PAR information.

If the PAR only indicates White/Caucasian, Black/Negro, or Other, then the PAR contains insufficient information for this variable. Additional information is required to determine the ethnicity. In addition, the driver's *name* is not a reliable indicator of ethnicity and **cannot be used** when selecting the applicable element value for this variable. For example, a name such as: Hector Smith, does not indicate the ethnicity (*e.g.*, Hispanic or Not Hispanic) since the person may or may not consider themselves to be of Hispanic descent.

**Third, use official records** (*e.g.*, *medical*). If the data needed cannot be obtained from the interviewee and is not available or usable from the PAR, then use official records, if available, to determine the correct element attribute.

**Element Attributes:****Hispanic or Latino**

is selected for drivers who consider themselves a person of Cuban, Mexican, Puerto Rico, South or Central American or other Spanish culture or origin, regardless of race. The term, "Spanish origin," can be used in addition to "Hispanic or Latino."

**Not Hispanic or Latino**

is selected for drivers who consider themselves as not being of Cuban, Mexican, Puerto Rico, South or Central American or other Spanish culture or origin, regardless of race.

**Unknown**

is selected when the source(s) available do not provide sufficient information to classify the driver's ethnic origin.

**OCCUPANT'S EYE WEAR**

**Screen Name:** Eye Wear  
**SAS Data Set:** OA  
**SAS Variable:** EYEWEAR  
**Oracle Name:** OCCUPANT.PICKEYEWEARTYPE

**Element Attributes:**

Oracle	SAS	
1	0	No
2	1	Eyeglasses/sunglasses
3	2	Contact lenses
4	3	Contact lenses with sunglasses
10	8	Other (specify)
9	9	Unknown

**Source:** Researcher determined — primary source is the interview and secondary sources includes vehicle inspection and medical records.

**Remarks:**

The occupant must be wearing the glasses/lenses at the time of the crash.

The presence of glasses in the vehicle does not in itself mean that an occupant was wearing them. Additional information must be obtained to determine that they were worn (injuries, air bag damage, etc.)

**No**

no eyeglasses/sunglasses or contact lenses were worn by this occupant.

**Eyeglasses/sunglasses**

if this occupant was wearing eyeglasses or sunglasses at the time of impact.

**Contact lenses**

if this occupant was wearing contact lenses at the time of impact.

**Contact lenses with sunglasses**

if the occupant is wearing contact lenses with sunglasses at the time of impact..

**Unknown**

it is not known if the occupant in this position was wearing eyewear at the time of impact..



**CHILD SAFETY SEAT USED**

**Screen Name:** Child Seat Used

**SAS Data Set:** OA

**SAS Variable:** CHUSED

**Oracle Name:** OCCUPANT.CHILDSEATAVAILABLE

**Element Attributes:**

Oracle	SAS	
1	0	No
2	1	Yes
3	9	Unknown

**Source:** Researcher determined-inputs include vehicle inspections, interview, police reports.

**Remarks:**

**No**  
is used when a child safety seat is not being used by this occupant.

**Yes**  
is used when a child safety seat is being used by this occupant.

**Unknown**  
is used when it is unknown if this person was using a child safety seat.

**POLICE REPORTED AIR BAG AVAILABILITY/FUNCTION**

**Screen Name:** Police Reported–Air Bag Avail/Function

**SAS Data Set:** *OA*

**SAS Variable:** *BAGAVRPT*

**Oracle Name:** *OCCUPANT.PICKPOLICEAIRBAG*

**Element Attributes:**

Oracle	SAS	
1	0	No air bag available
3	2	Deployed
4	3	Not deployed
5	4	Unknown if deployed
6	9	Police indicated "unknown"
10	7	Not reported

**Source:** Police report.

**Remarks:**

This variable captures what was documented on the PAR regarding the availability and functioning of any air bag system. The entire PAR (especially narrative) must be reviewed to make a determination to code this variable.

**Not reported**

is used if no coded data block exists on the crash report and no other information is available. If a coded data block exists and left blank use this attribute.

**POLICE REPORTED BELT USE**

**Screen Name:** Police Reported—Belt Use  
**SAS Data Set:** *OA*  
**SAS Variable:** *PARUSE*  
**Oracle Name:** *OCCUPANT.PICKPOLICEBELTUSE*

**Element Attributes:**

Oracle	SAS	
1	0	None used
3	2	Shoulder belt
4	3	Lap belt
5	4	Lap and shoulder belt
6	5	Belt used, type not specified
7	6	Child safety seat
8	7	Automatic belt
9	8	Other type belt (specify)
10	9	Police indicated "unknown"
11	10	Not Reported

**Source:** Police report.

**Remarks:**

This variable captures what was documented on the PAR regarding occupant use of available vehicle restraints (*i.e.*, manual belts, child safety seat, or automatic restraints). Select the first attribute which applies. The entire PAR (especially narrative) must be reviewed to make a determination to code this variable.

**None used**

includes if the PAR indicates the belt is unavailable.

**Belt used, type not specified**

is used when the PAR indicates that available *belts* were used, but it is unclear what type of belts were actually in use.

**Not reported**

is used if no coded data block exists on the crash report and no other information is available. If a coded data block exists and left blank use this attribute.

**POLICE INJURY SEVERITY (POLICE RATING)**

**Screen Name:** PAR Severity

**SAS Data Set:** OA

**SAS Variable:** INJSEV

**Oracle Name:** OCCUPANT.PARKABCOU

**Element Attributes:**

Oracle	SAS	
1	0	O — No injury
2	1	C — Possible injury
3	2	B — Nonincapacitating injury
4	3	A — Incapacitating injury
5	4	K — Killed
6	5	U — Injury, severity unknown
7	6	Died prior to crash
8	9	Unknown

**Source:** Police report.

**Remarks:**

If the police report contains a detailed description of the injuries but does not translate the injuries into the KABCO codes, use the police method for doing so. For example, injuries which are considered to be of an incapacitating nature are classified as "A", Nonincapacitating-evident injuries are classified as "B", and possible injuries are "C". Property damage only (i.e., no injury) is classified as "O".

Enter **Injured, Severity Unknown** if the police report indicates a "U" or in any other way communicates the idea that the person was injured but the severity is unknown.

Enter **Died Prior to Crash** only if the police explicitly states the person died prior to the crash. This code is also used if the police report indicates the person died as a result of natural causes (e.g., heart attack), disease, drug overdose or alcohol poisoning. This code does not apply if the police report specifically states that the cause of death is a result of crash-related injury or that on-set occurred after the crash. Further clarification: this code applies if the police report indicates that the person died as a result of natural causes (e.g., heart attack), disease, drug overdose or alcohol poisoning, but is silent about the time of on-set and if on-set is the result of injuries sustained in the crash.

As a general rule, if the PAR is "blank" where the injury severity is assessed and the person was at the scene during the police investigation, enter **No Injury (O)**. If the PAR is "blank" and the person was not present during the police investigation, enter **Unknown**.

**U — Injury, severity unknown**

is used when the police report indicates a "U" or in any other way communicates the idea that the person was injured but their severity is unknown.

**Died prior to crash**

is only used if the police explicitly so indicate.

The following states use the KABCO injury coding scheme: Illinois (incl. Chicago), Michigan, New Mexico, North Carolina, Texas (incl. Dallas), Wisconsin, and the city of Los Angeles.

Not all states use the KABCOU scheme. Listed below, by state, are alternative schemes; a mapping to the NASS scheme is provided.

State	PAR Code/Definition		NASS Scheme/Code
<b>Alabama</b>	K	= Killed	K - 4
	A	= Visible or carried from scene	A - 3
	B	= Bruise/abrasion/swelling	B - 2
	C	= Not visible - has pain/faint	C - 1
	Blank	= No documentation of driver or occupant injury	O - 0
	99	= Unknown injury	- 9
<b>Arizona</b>	5	= Fatal Injury	K - 4
	4	= Incapacitating injury	A - 3
	3	= Non-incapacitating Evident	B - 2
	2	= Possible Injury	C - 1
	1	= No injury	O - 0
	6	= Unknown	U - 9

## Police Injury Severity (Police Rating) (cont'd)

Page 3 of 8

<b>California</b>	1	= Fatal	K - 4
	2	= Severe injury	A - 3
	3	= Other visible injury	B - 2
	4	= Complaint of pain	C - 1
	Blank	= Occupant present	O - 0
	Blank	= Occupant not present	- 9

<b>Colorado</b>	5	= Fatal	K - 4
	4	= Evident - incapacitating	A - 3
	3	= Evident - non-incapacitating	B - 2
	2	= Possible injury	C - 1
	1	= No injury	O - 0

\*There is a box at the top of the PAR indicating number of persons injured. If this box is marked 0 and the injury code is left "blank", assume "No injury". If the box is marked 1 (or more) pertaining to the vehicle occupants in question and the injury code is "blank", assume "Injured, severity unknown". If "blanks" are present in both the persons injured box and the injury code box, assume "Unknown".

<b>Florida</b>	5	= Fatal (within 90 days) injury	K - 4
	4	= Incapacitating	A - 3
	3	= Non-Incapacitating	B - 2
	2	= Possible	C - 1
	1	= None	O - 0
		= No set unknown code	- 9
	6	= Non-traffic fatality	- 9

<b>Illinois</b>	K	= Fatal	K - 4
	A	= Incapacitating Injury	A - 3
	B	= Non-Incapacitating Injury	B - 2
	C	= Reported not evident	C - 1
	O	= No indication of injury	O - 0
		= No set unknown code	- 9

**Indiana**

**Injury Status:**

- i. Code “refused” as no injury when “Nature of Most Severe Injury” is blank.
- ii. If the officer selects a code for “Nature of Most Severe Injury” that does not correspond to the code for “Victim’s Injury Status,”
  - 1. Use the “Victim’s Injury Status” to determine the crash stratum and injury severity.
  - 2. If “Victim’s Injury Status” is blank, default to “Nature of Most Severe Injury.”
  - 3. If “Victim’s Injury Status” indicates a fatal injury, verify that someone was killed on the front of the PAR. Do not use the block on the front of the PAR showing number injured to verify other injuries.
  - 4. If the “Nature of Most Severe Injury” information reflects a more severe injury than that reflected by the “Injury Status” box, upgrade the injury to match iii. Use the table below to determine injury status.
- iii. Use the table below to determine injury status

\*There is a box at the top of the PAR indicating number of persons injured. If this box is marked 0 and the injury code is left "blank", assume "No injury". If the box is marked 1 (or more) pertaining to the vehicle occupants in question and the injury code is "blank", assume "Injured, severity unknown". If "blanks" are present in both the persons injured box and the injury code box, assume "Unknown".

Nature of Most Severe Injury	Victim's Injury Status	NASS Scheme/Code
Any Entry	Fatal injury	K (see note ii above)
Severed	Incapacitating - Nonfatal Injury	A
Internal	Incapacitating -- Nonfatal Injury	A
Minor Burn	Non-incapacitating B Nonfatal Injury	B
Severe Burn	Incapacitating -- Nonfatal Injury	A
Abrasion	Non-incapacitating B Nonfatal Injury	B
Minor Bleeding	Non-incapacitating B Nonfatal Injury	B
Severe Bleeding (arterial)	Incapacitating -- Nonfatal Injury	A
Fracture/dislocation	Incapacitating -- Nonfatal Injury	A
Contusion/bruise	Non-incapacitating B Nonfatal Injury	B
Complaint of pain	Possible B Nonfatal Injury	C
None Visible	Not Reported B Nonfatal Injury	O
Other (explain in narrative)	Possible B Nonfatal Injury	C
Unknown	Unknown B Nonfatal Injury	U



<b>State</b>	<b>PAR Code/Definition</b>		<b>NASS Scheme/ Code</b>
<b>Iowa</b>			
	1	= Fatal Injury	K - 4
	2	= Major (incapacitating)	A - 3
	3	= Minor (bruises and abrasions)	B - 2
	4	= Possible (complaint of pain)	C - 1
	5	= Uninjured	O - 0
	9	= Unknown	U - 9
<b>Kentucky</b>			
	1	= Fatal	K - 4
	2	= Incapacitating	A - 3
	3	= Non-Incapacitating	B - 2
	4	= Possible Injury	C - 1
	5	= None Detected	O - 0
<p>*There is a box at the top of the PAR indicating number of persons injured. If this box is marked 0 and the injury code is left "blank", assume "No injury". If the box is marked 1 (or more) pertaining to the vehicle occupants in question and the injury code is "blank", assume "Injured, severity unknown". If "blanks" are present in both the persons injured box and the injury code box, assume "Unknown".</p>			
<b>Maryland</b>			
	05	= Fatal	K - 4
	04	= Disabled (Incapacitated)	A - 3
	03	= Injured - not Incapacitated	B - 2
	02	= Possible injury	C - 1
	01	= Not Injured (& present)	O - 0
	01	= Not Known (if left scene)	- 9
	Blank	= No documentation of driver or occupants on front of PAR	- 9

<b>State</b>	<b>PAR Code/Definition</b>		<b>NASS Scheme/ Code</b>
<b>Massachusetts</b>			
	1	= Fatal Injury	K - 4
	2	= Incapacitating	A - 3
	3	= Non-incapacitating	B - 2
	4	= Possible	C - 1
	5	= No Injury	O - 0
	99	= Unknown	- 9
<b>Missouri</b>			
	1	= Fatal	K - 4
	2	= Disabling	A - 3
	3	= Evident-Not Disabling	B - 2
	4	= Probable-Not Apparent	C - 1
	5	= None Apparent	O - 0
	6	= Unknown	U - 9
<b>Nebraska</b>			
	1	= Killed	K - 4
	2	= Disabling - cannot leave scene without assistance	A - 3
	3	= Visible but not disabling	B - 2
	4	= Possible but not visible	C - 1
	Blank	= Occupant present	O - 0
	Blank	= Occupant not present	- 9
<b>North Carolina</b>			
	K-1	Killed	K - 4
	A-2	A-Type Injury (Disabling)	A - 3
	B-3	B-Type Injury (Evident)	B - 2
	C-4	C-Type Injury (Possible)	C - 1
	O-5	No Injury	O - 0
	-6	Unknown	- 9

**New Jersey**

<b>Victim's Physical Condition [PAR Column 86]</b>	<b>Location of Most Severe Injury [PAR Column 89]</b>	<b>Type of Most Severe Physical Injury [PAR Column 90]</b>	<b>NASS Scheme/Code</b>
01 Killed	01-12 Any Entry	01-08 Any Entry	K-4
02 Incapacitated	01-12 Any Entry	01-08 Any Entry	A-3
03 Moderate Injury or 04 Complaint of Pain	01-12 Any Entry	01 Amputation 02 Concussion 03 Internal 04 Fracture/Dislocation	A-3
03 Moderate Injury or 04 Complaint of Pain	03 Eye	04 Bleeding 06 Burn 08 Complaint of Pain	A-3
03 Moderate Injury	01-12 Any Entry	04 Bleeding 05 Contusion/Bruise/ Abrasion	B-2
04 Complaint of Pain-	01, 02, 04-12 Any Entry(Except Eye)	08 Complaint of Pain	C-1
( - )	( - ) = N/A	( - )	O-0
Blank	Blank	Blank	O-0
00 = Unknown	00 = Unknown	00 = Unknown	-9

**New York**

<b>Location of Most Severe Physical Complaint [PAR Column 14]</b>	<b>Type of Physical Complaint [PAR Column 15]</b>	<b>Victim's Physical Condition [PAR Column 16]</b>	<b>NASS Scheme/ Code</b>
1-12 Any Entry	1-14 Any Entry	1 Apparent Death	K-4
1-12 Any Entry	Any Entry	2 Unconscious 3 Semi-Conscious 4 Incoherent	A-3
1-12 Any Entry	1 Amputation 2 Concussion 3 Internal 5 Severe Bleeding 7 Moderate Burn 8 Severe Burn, 9 Fracture-Dislocation	5 Shock 6 Conscious	A-3
3 Eye	4 Minor Bleeding 6 Minor Burn 12 Complaint of Pain	5 Shock 6 Conscious	A-3
1, 2, 4-12 Any Entry (Except Eye)	4 Minor Bleeding 6 Minor Burn	5 Shock 6 Conscious	B-2
1-12 Any Entry	10 Contusion-Bruise 11 Abrasion	5 Shock 6 Conscious	B-2
2, 4-12 Any Entry (Except Eye)	12 Complaint of Pain 13 None Visible 14 Whiplash	5 Shock 6 Conscious	C-1
1-12 Any Entry or (X) = Unknown	13 None Visible	6 Conscious or ( - )	C-1
1, 2, 4-12 Any Entry (Except Eye)	(X) = Unknown	6 Conscious	C-1
Blank or ( - )	13 None Visible or ( - )	6 Conscious	O-0
Blank or ( - )	Blank or ( - )	Blank or ( - )	O-0
(X) = Unknown	(X) = Unknown	(X) = Unknown	-9

State	PAR Code/Definition		NASS Scheme/ Code
<b>Pennsylvania</b>			
	1	= Killed	K - 4
	2	= Major Injury	A - 3
	3	= Moderate Injury	B - 2
	4	= Minor Injury	C - 1
	0	= Not Injured	O - 0
	8	= Injury, Unknown Severity	- 5
	9	= Unknown if Injury	- 9
<b>Texas</b>			
	4	= Killed	K - 4
	1	= Incapacitating Injury	A - 3
	2	= Non-Incapacitating Injury	B - 2
	3	= Possible Injury	C - 1
	5	= Not Injured	O - 0
		= Not Set Unknown Code	- 9
<b>Washington</b>			
	1	= No Injury	O - 0
	2	= Dead at Scene	K - 4
	3	= Dead on Arrival	K - 4
	4	= Dead at Hospital	K - 4
	5	= Disabling	A - 3
	6	= Non Disabling (Evident Injury)	B - 2
	7	= Possible Injury	C - 1
	0	= Unknown	U - 9

## **Ejection Overview**

Page 1 of 2

Variables in this section provide an assessment of the occurrence of ejection of an occupant. These variables in this section are coded based upon vehicle inspection. Verification of questionable ejections will come from the interview.

Historically, ejection from the vehicle has been a major cause of increased fatalities and serious injuries. The chances of being killed if ejected are about 1 in 5; whereas, if the occupant remains inside the vehicle, the chances of dying are reduced to about 1 in 200. Unfortunately ejection from the vehicle is not that uncommon and has become a significant part of the fatality and severe injury crashes. Further contributing to the ejection problem is the increase in window surface area and more hatchback models. Despite the current emphasis on restraint use through legal requirements for occupants to be seat belted, a significant portion of the population continues to be unrestrained and at risk to ejection.

A problem not often addressed is that of partial ejection. This refers to those instances where some part but not all of an occupant's body is, at some time during the crash sequence, outside the occupant compartment. Although it would not seem to be a problem it can be, and often is, fatal if the part outside is the occupant's head. Because of the dynamics of the vehicle and the kinematics of the occupants during an ejection sequence, it is often the occupant's own vehicle which causes the injury as it rolls onto the occupant.

Federal Motor Vehicle Safety Standards (FMVSS) which were developed in response to the problems seen in these areas are FMVSS 201 (Occupant Protection in Interior Impact), FMVSS 205 (Glazing Materials), FMVSS 206 (Door Locks and Door Retention Components), FMVSS 212 (Windshield Mounting), and FMVSS 216 (Roof Crush Resistance Passenger Cars).

Analytically this group of variables is a stand alone package most of the time. It can form the basis of an analysis without the use or comparison to any other variables. This would be used mostly in exploring the number and types of ejections. Expanding the scope somewhat to include injury severity allows a determination of the increase or decrease in the ejection problem. Inclusion of injury source would provide an idea of the severity of all occurrences of entrapment and ejection. Injury source also provides an idea of the kinematics of the occupant during the sequence. The addition of a cross-tabulation for AIS level would show the relative severity between the injuries incurred inside the vehicle and those outside the vehicle.

Other areas of interest to the analyst are the ejection route and performance of integral structures. The integral structure performance is directly governed by the FMVSS 206 and 212. These areas are of increasing interest to NHTSA since the real world performance can help support the findings from the staged collisions and will help determine the effectiveness of the standards.

Gathering the data, which will allow the researcher to accurately select the variables, is a multistage process. It will begin with the PAR which may give an indication of ejection. Inspection of the

vehicle will provide the evidence needed to substantiate the ejection. Further, documentation should be obtained through the scene inspection, interview, and injury data. Particular attention should be paid to the vehicle inspection since most evidence of ejection will be less apparent and not easily discerned.

In summary, this group of variables assesses the level of a very significant problem in today's crash picture. Correct accurate assessment is a result of a multistage research process, which will be individualized by case. Attention to detail will result in a correct assessment. This is an example which is directly tied to the FMVSS, and all gathered data results are a direct evaluation of the applicable standards.

### **Special Conditions for *Ejection and Entrapment***

Using the guidelines given below, *Ejection/Entrapment* variables may be completed for towed CDS applicable vehicles based on PAR and crash severity when there is ***no vehicle inspection, no interview, and the answer is obvious***. If there is any doubt, annotate accordingly and select **Unknown**.

1. Select **Not entrapped** for occupants fleeing from towed CDS applicable vehicles.
2. For other towed CDS applicable vehicles:
  - (a) **No Ejection** may be used ***if the PAR specifically so states for a given occupant***. For all other occupants about whom the PAR is silent, select **Unknown**.

If the PAR indicates that an occupant is ejected, this is sufficient to select **Complete ejection** or **Partial ejection** if the PAR so states. If complete versus partial ejection is not stated on the PAR, then select **Ejection, unknown degree** may be used.

**Note**, however, that these three variables can be used only if the PAR provides sufficient detail.

- (b) Entrapment may be selected as **Not entrapped** ***if the PAR specifically so states for a given occupant***. For all other occupants about whom the PAR is silent, use **Unknown**.

Recall, however, that if the PAR states that an occupant is entrapped, this is ***not sufficient*** to select Entrapment (because PAR definition of entrapment is different from NASS definition). Unless Entrapment is verified through other sources, Entrapment must be selected as **Unknown**.

EJECTION LIST

Occupant Form, Case #2007-996-900015/Vehicle # 2/Occupant #1

OCCUPANT EJECTION ENTRAPMENT SEAT AIR BAG CHILD SEAT SEAT BELT INJURY INJURY CODES LOG REVIEW

LIST | DETAIL | COMMENTS

Ejection #	Occ #	Type	Area	Medium
------------	-------	------	------	--------

Save Close

EJECTION DETAIL

Occupant Form, Case #2007-996-900015/Vehicle # 2/Occupant #1

OCCUPANT EJECTION ENTRAPMENT SEAT AIR BAG CHILD SEAT SEAT BELT INJURY INJURY CODES LOG REVIEW

LIST | DETAIL | COMMENTS

Occupants

Type

Area

Medium

Medium Status

Ejection #  of 0



**TYPE OF EJECTION**

**Screen Name:** Type  
**SAS Data Set:** OA  
**SAS Variable:** EJECTION  
**Oracle Name:** EJECTION.PICKEJECTIONTYPE

**Element Value:**

Oracle	SAS	
1	0	No ejection
2	1	Complete ejection
3	2	Partial ejection
4	3	Ejection, unknown degree
5	9	Unknown

**Source:** Researcher determined--inputs include the vehicle inspection, interviewee, medical records, and the police report.

**Remarks:**

Ejection refers to persons being completely or partially thrown from the vehicle as a result of an impact or rollover. If a person already has a body part protruding from the vehicle (e.g., an elbow, arm, etc.) and the PDOF acting on the vehicle would likely cause further protrusions of the body part, then at least partial ejection is selected.

**No Ejection**

is selected when there is no indication of any occupant being either partially or fully ejected from the vehicle.

**Complete ejection**

is selected when an the occupant’s body is entirely outside of the vehicle during the crash sequence. It is important to note that even though the body may be outside the vehicle, it may still be in contact with the vehicle. This code also includes occupants who are not initially in the passenger and contiguous cargo area of the vehicle (e.g., pickup beds, boot of a convertible, and persons riding on open tailgates).

**Partial ejection**

is selected when part of the occupant’s body remains **in** the vehicle, and any part of it is forced outside of the vehicle during the crash sequence. This code **does not apply** to those occupants who are not initially in the passenger and contiguous cargo area of the vehicle, they are indicated as “**Complete ejection**”.

**Ejection, unknown degree**

is selected when it is suspected (or known) that an ejection of the occupant occurred, however, at the time of the vehicle inspection the researcher was unable to determine if the ejection was **Partial** or **Complete**.

**Unknown**

is selected when:

- the vehicle has been completely repaired
- it cannot be determined if an ejection is applicable.

**EJECTION AREA**

Page 1 of 2

**Screen Name:** Area**Oracle Name:** *EJECTION.PICKEJECTIONAREA***Element Attributes:**

Oracle	SAS	
11	0	[No ejection]
1	1	Windshield
2	2	Left front
3	3	Right front
4	4	Left rear
5	5	Right rear
6	6	Rear
7	7	Roof
	89	[Unknown if ejected]
8	98	Other area ( <i>e.g.</i> , back of pickup, etc.) (specify)
9	99	Unknown

**Source:** Researcher determined — inputs include the vehicle inspection, interviewee, and the police report.**Remarks:**

The coding of ejection for this variable is done by either linking it to an ejection that has been noted during the vehicle inspection, if present, or inserting one. If No Ejections is selected a link must be completed. In either condition, the information can be modified.

**Left Front**

is defined as starting at the front of the vehicle and ending at the rear portion of the left front door.

**Right Front**

is defined as starting at the front of the vehicle and ending at the rear portion of the right front door.

**Left Rear**

is defined as starting at the b-pillar and extending to the rear of the vehicle.

**Right Rear**

is defined as starting at the b-pillar and extending to the rear of the vehicle.

**Rear**

is restricted to persons riding in a passenger compartment, who are ejected through the rear window, tailgate (*e.g.*, station wagon), hatchback, etc.

**Roof**

applies to all hardtops, convertibles, sun roofs, t-bar roofs, and detachable hardtops (such as fiberglass tops) that are used to cover areas designed for passenger protection.

When **Ejection Area** equals **Roof**, follow examples illustrated below when selecting **Ejection Medium** and **Medium Status** (immediately prior to impact).

<b>Ejection</b>	<b>Roof Type</b>	<b>Area</b>	<b>Ejection Medium</b>	<b>Medium Status</b>
Ejection	Hardtop, ripped open during crash	Roof	Integral Structure	Integral Structure
Ejection	Removable hardtop, <u>attached</u> prior to the crash	Roof	Integral Structure	Integral Structure
Ejection	Removable hardtop, <u>detached</u> prior to crash	Roof	Non-fixed roof structure	Open
Ejection	Convertible, in down or open position prior to crash	Roof	Non-fixed roof structure	Open
Ejection	Convertible, in closed position	Roof	Non-fixed roof structure	Closed
Ejection	Sun or t-bar, closed and ripped open during the crash	Roof	Non-fixed roof structure	Closed
Ejection	Sun or t-bar, open/removed prior to the crash	Roof	Non-fixed roof structure	Open

The specific Ejection--Area attributes are designated for use with areas designed for passenger protection (e.g., passenger cars, vans, light truck cabs, self-contained mini- RVs and mini-motor homes). Trailers, add-on campers, etc., are to be assigned **Other area**.

**Other area**

also applies to persons riding on open tailgates.

**Unknown**

if the sole source for the ejection is the police report, unless the PAR provides a clear, distinguishable avenue of occupant ejection.

**EJECTION MEDIUM**

**Screen Name:** Medium

**SAS Data Set:** *OA*

**SAS Variable:** *EJECTMED*

**Oracle Name:** *EJECTION.PICKEJECTIONMEDIUM*

**Element Attributes:**

Oracle	SAS	
11	0	[No ejection]
1	1	Door/hatch/tailgate
2	2	Nonfixed roof structure
3	3	Fixed glazing
4	4	Nonfixed glazing (specify)
5	5	Integral structure
	79	[Unknown ejection area]
	89	[Unknown if ejected]
6	98	Other medium (specify)
7	99	Unknown

**Source:** Researcher determined — inputs include the vehicle inspection, interviewee, and the police report.

**Remarks:**

The coding of ejection for this variable is done by either linking it to an ejection that has been noted during the vehicle inspection, if present, or inserting one. In either condition, the information can be modified.

**Door/hatch/tailgate**

includes any door, hatch, or tailgate that is opened during the course of the impact sequence.

**Non-fixed roof structure**

applies only to convertible, sun roofs, t-bar roofs, and removable hardtops when detached / retracted prior to the crash.

**Fixed glazing**

refers to any glazing in the vehicle that cannot be opened

**Non-fixed glazing**

refers to any glazing in the vehicle that can be opened to any degree.

**Integral structure**

includes removable hardtops when attached to the vehicle prior to the crash. This also should be used when any vehicle structure, not designed to be opened (*e.g.*, standard roof), is torn open during the crash such as to permit ejection.

**Other medium**

applies to persons riding in pickup beds, on open tailgates, and for other situations which cannot be classified above. In addition, use this attribute when someone is ejected from a trailer, add-on camper, etc.

**Unknown**

if the sole source for the ejection is the police report, unless the PAR provides a clear, distinguishable avenue of occupant ejection.

## EJECTION MEDIUM STATUS (IMMEDIATELY PRIOR TO IMPACT)

Page 1 of 2

**Screen Name:** Medium Status

**SAS Data Set:** OA

**SAS Variable:** MEDSTA

**Oracle Name:** EJECTION.PICKEJECTIONMEDIUMSTATUS

**Element Attributes:**

Oracle	SAS	
11	0	[No ejection]
1	1	Open
2	2	Closed
3	3	[Integral Structure]
	79	[Unknown ejection area]
	89	[Unknown if ejected]
4	99	Unknown status

**Source:** Researcher determined — inputs include the vehicle inspection, interviewee, and the police report.

**Remarks:**

The coding of ejection for this variable is done by either linking it to an ejection that has been noted during the vehicle inspection, if present, or inserting one. In either condition, the information can be modified. This variable is a description of the status of the area through which an occupant was ejected and is the status of the medium immediately prior to the impact.

**Open**

applies to convertible roofs, sun roofs, t-bar roofs, windows, doors or tailgates that are completely or partially open immediately prior to impact, or to other open areas of vehicles such as pickup beds, etc.

**Closed**

refers to a window that is completely closed when damaged, or to a convertible, sun, or t-bar roof that is closed when damaged. Sun and t-bar roofs are captured here if the ejection occurred through the designed opening in the sun or t-bar roof. However, if the roof was of a sun or t-bar type but the ejection occurred because a sizable opening was torn in the roof structure, then select **Integral structure**. This is also used for fixed glazings such as windshields and backlights which are in place prior to the collision. This also refers to a door that is closed, but when damaged, experiences latch and/or hinge malfunction causing the door to open.

**Integral structure**

includes removable hardtops when attached to the vehicle prior to the crash. This also should be used when any vehicle structure, not designed to be opened (*e.g.*, standard roof), is torn open during the crash such as to permit ejection.

**Unknown**

if the sole source for the ejection is the police report, unless there is a clear indication on the PAR of the medium status.



EJECTION COMMENTS

Occupant Form, Case #2007-996-900015/Vehicle # 2/Occupant #1

OCCUPANT | EJECTION | ENTRAPMENT | SEAT | AIR BAG | CHILD SEAT | SEAT BELT | INJURY | INJURY CODES | LOG | REVIEW

LIST | DETAIL | COMMENTS

Save Close

This screen is for adding further annotations about any ejection.

### **Entrapment Overview**

Entrapment poses a different problem area. Recent years have brought about a vast improvement in the delivery of emergency medical attention to motor vehicle crash victims. This improvement has been achieved through the establishment of regional trauma centers, well equipped Mobile Intensive Care Units manned by trained paramedics even in rural areas, and a general increase in the knowledge of how to treat acute trauma. This improvement has not helped those victims who are restrained within the vehicle by deformed components. The improved care cannot be delivered because the personnel are unable to get to the victim, remove the victim from the vehicle, and deliver the victim to a treatment facility in a reasonable amount of time.

Entrapment is caused by the structure components of the vehicle entangling or intermingling with the occupants, preventing the occupants from exiting the vehicle. Manufacturers have designed crumple zones into vehicles to absorb energy. These structural parts are designed to crumple in a predetermined pattern to absorb the energy during a crash while maintaining the integrity of the passenger compartment. In so doing, the occupants of the vehicle can become entrapped by the structure of the vehicle deforming around them.

Enter any observations or indications of possible entrapment or mobility restrictions. Careful observations should be made of intruding vehicle components, i.e., jammed doors, crushed roof, or other mechanisms that might have restrained the occupants, restricted their mobility, or limited egress from the vehicle.

Extrication tool marks are an indication of entrapment. Although, the cutting off of the roof of a vehicle is not an indication of entrapment.

ENTRAPMENT DETAILS

Occupant Form, Case #2007-996-900015/Vehicle # 2/Occupant #1

OCCUPANT | EJECTION | ENTRAPMENT | SEAT | AIR BAG | CHILD SEAT | SEAT BELT | INJURY | INJURY CODES | LOG | REVIEW

DETAILS | COMMENT

Entrapment

Occupant Mobility

Intrusions > 2cm

## ENTRAPMENT

Page 1 of 2

**Screen Name:** Entrapment

**SAS Data Set:** *OA*

**SAS Variable:** *ENTRAP*

**Oracle Name:** *ENTRAPMENT.PICKENTRAPMENT*

**Element Attributes:**

Oracle	SAS	
1	0	Not entrapped/exit not inhibited
2	1	Entrapped/pinned — mechanically restrained
5	2	Could not exit vehicle due to jammed doors
6	3	Could not exit vehicle due to external circumstances (specify)
4	9	Unknown

**Source:** Researcher determined — inputs include the vehicle inspection, interview and police report.

**Remarks:****Not entrapped/exit not inhibited**

is used when this occupant exited the vehicle and his/her egress was not inhibited in any way by intruding vehicle components, jammed doors, etc.

**Entrapped/pinned — mechanically restrained**

is used when this occupant was physically restrained in the seat position by an intruding vehicle component. The occupant could not move from the post impact position without some part of the vehicle being cut away, bent or moved.

**Could not exit vehicle due to jammed doors**

is used when this occupant could not exit the vehicle due to jammed door(s). This occupant, however could move about within the vehicle. Refers to doors, not row specific. Doors are usually used for ingress/egress of the occupant seating area. A door must have hinges and a locking mechanism. Except as follows:

- If a barrier is placed between rows, such as in some taxis and limos, jammed doors would be coded by specific rows.

**Could not exit vehicle due to external circumstances (specify)**

is used when exiting the vehicle could cause more harm to the occupants. Examples are:

- Fire
- Live electrical wires
- High water

This code requires a specific annotation.

**Unknown**

is used when there is no knowledge of the manner of this occupant's exit from the vehicle and generally, no inspection of the vehicle.

**OCCUPANT MOBILITY**

**Screen Name:** Occupant Mobility

**SAS Data Set:** *OA*

**SAS Variable:** *OCCMOBIL*

**Oracle Name:** *ENTRAPMENT.MOBILITYRESTRICTION*

**Element Attributes:**

Oracle	SAS	
1	0	Occupant fatal before removed from vehicle
2	1	Removed from vehicle while unconscious or not oriented to time or place
3	2	Removed from vehicle due to perceived serious injuries
4	3	Exited from vehicle with some assistance
5	4	Exited from vehicle under own power
6	5	Occupant fully ejected
7	8	Removed from vehicle for other reasons (specify):
8	9	Unknown

**Source:** Researcher determined — inputs include fire and or EMS personnel/records, interviews, witnesses, medical records, PAR.

**Remarks:**

The variable attributes are hierarchical.

Do not rely on the interview alone to make this selection. Consider all information (EMS, medicals, etc.) when making your selection.

**Occupant fatal before removed from vehicle**

is used when it can be determined that the occupant was deceased prior to removal from the vehicle.

**Removed from vehicle while unconscious or not oriented to time or place**

is used when it can be determined that the occupant was unconscious or had diminished awareness (not oriented to time and place) due to the crash when they were removed from the vehicle.

**Removed from the vehicle due to perceived serious injuries**

is used when it can be determined that the occupant was injured but conscious and oriented and had to be removed from the vehicle due to their serious injuries (*e.g.* broken femur). A key factor to consider is the perceived seriousness of the injury. Generally this involves removal by EMS personnel.

**Exited the vehicle with some assistance**

is used when the occupant was able to exit the vehicle partially under their own power but their condition was such that some assistance in exiting was necessary.

**Exited the vehicle under own power**

is used when the occupant was able to exit the vehicle without assistance from another person.

**Occupant fully ejected**

is used when the occupant was completely ejected from the vehicle.

**Removed from vehicle for other reasons (specify):**

includes those people who require assistance in exiting the vehicle and would have required assistance even if there had not been a crash i.e., infants, severely disabled, intoxicated persons.

**Unknown**

is used when the researcher cannot reasonably determine the manner of exit by the occupant.

ENTRAPMENT/COMMENT

The screenshot shows a software window titled "Occupant Form, Case #2007-996-900015/Vehicle # 2/Occupant #1". The window has a menu bar with options: OCCUPANT, EJECTION, ENTRAPMENT, SEAT, AIR BAG, CHILD SEAT, SEAT BELT, INJURY, INJURY CODES, LOG, and REVIEW. Below the menu bar are two tabs: "DETAILS" and "COMMENT". The "COMMENT" tab is active, and a button labeled "No Entrapment" is visible. The main area of the form is a large, empty white rectangle. At the bottom right of the window, there are two buttons: "Save" (with a green checkmark icon) and "Close" (with a red 'X' icon).

This screen is for adding further annotations about any entrapment.

The screenshot shows the same software window as above. In this view, a button labeled "Clear All" is visible above the "No Entrapment" button. The main area of the form is a large, empty white rectangle. At the bottom right of the window, there are two buttons: "Save" (with a green checkmark icon) and "Close" (with a red 'X' icon).

If no entrapment is identified, select "No Entrapment" button and the application prefills.



SEAT DEFINITION





















Occupant Form, Case #2007-996-900015/Vehicle # 2/Occupant #1

OCCUPANT | EJECTION | ENTRAPMENT | SEAT | AIR BAG | CHILD SEAT | SEAT BELT | INJURY | INJURY CODES | LOG | REVIEW

DEFINITION | ATTRIBUTES

Row  Location  Posture

UNKNOWN

Role  Seat Type

Save Close

**OCCUPANT'S SEAT POSITION**

**Screen Name:** Seat Location Identification

**SAS Data Set:** *OA*

**SAS Variable:** *SEATPOS*

**Oracle Name:** *SEATLOC.SEATROW and SEATLOC.SEATLOCATION*

**Element Attributes:**

**Front Row**

- 11 Left side
- 12 Middle
- 13 Right side
- 19 Unknown seat

**Fourth Row**

- 41 Left side
- 42 Middle
- 43 Right side
- 44 Far right side
- 49 Unknown seat

**Second Row**

- 21 Left side
- 22 Middle
- 23 Right side
- 24 Far right side
- 29 Unknown seat

**Fifth Row**

- 51 Left side
- 52 Middle
- 53 Right side
- 54 Far right side
- 59 Unknown seat

**Third Row**

- 31 Left side
- 32 Middle
- 33 Right side
- 34 Far right side
- 39 Unknown seat

**Other or unknown seating**

- 97 In or on unenclosed area (specify)
- 98 Other enclosed area (specify)
- 99 Unknown seat location

**Source:** Interviewee, police report and vehicle inspection

**Remarks:**

SEATING POSITIONS INDICATE AREAS OF THE VEHICLE, AND MAY NOT INDICATE THE ACTUAL PRESENCE OF A SEAT.

Identify the seat location where this occupant was located. "Click" on the appropriate seat on the screen. "Far right side" is only to be used if the seat has four seating positions.

More than one person may be assigned to a seating position. When this happens, the appropriate **Posture** must be selected to account for this.

The seating position by the steering wheel should be assigned to the assumed driver of a hit-and-run vehicle unless evidence indicates a different position for the person or persons.

If a person is between two bucket seats, then they are assigned to that position and their **Posture** is "Sitting on a console". An occupant sitting side-by-side of another occupant in the same seating position is placed in that position with their **Posture** indicated as "Sitting side by side another occupant" and the posture is described in the place indicated.

If the only seat in the front seating area is a driver's seat (*e.g.*, bucket, pedestal, etc.) and the occupant was in the area but not in the seat, assign the appropriate seating position (maybe the front right seating location) and the "Posture" will be indicated appropriately

The area at the rear of the vehicle is the location to indicate those occupants riding on a fender, the boot of a convertible, the open cargo box on a light truck, etc. or for anyone in the sixth or higher numbered seat area. See below for clarification.

If seating in the vehicle is longitudinal rather than lateral, use the basic idea of a vehicle interior being divided laterally into roughly equal thirds and visualize lateral rows of seats to determine what seat position is the best descriptor.

Persons appended to the vehicle in motion are not considered to be occupants of the vehicle.

**In or on Unenclosed Area**

includes those occupants riding on a fender, the boot of a convertible, the open cargo box on a light truck, etc.

To select "Unenclosed area", you must first "click on" the large area in the rear of the vehicle on the screen. Then using the variable **Seat Type**, you will select "In or on other Unenclosed area (specify)."

**Other enclosed area (specify)**

is used when any seat row is folded down or removed prior to the crash. A pickup truck with jump seats that are folded away, the status of the seat is the determining factor. Cargo areas of hatchback and station wagons that are covered by a shelf or curtain are considered cargo areas. The area above the shelf or curtain is considered as "other enclosed area." Use concise language in identifying the area in the specify window.

**Other Seat**

is used for any position in the sixth or higher numbered seat area (highly unlikely). In addition, use this code when an occupant(s) is in an enclosed area where no defined seating exists.

To select "Other seat", you must first "click on" the large area in the rear of the vehicle on the screen. Then using the variable **Seat Type**, you will select "In other Enclosed area (specify)."

**Unknown Seat**

is used when the seating position for this occupant is unknown but the row is known. Unknown seat should be used only after exhausting all other means of determining seating position.

**OCCUPANT'S POSTURE**

**Screen Name:** Posture

**SAS Data Set:** OA

**SAS Variable:** POSTURE

**Oracle Name:** OCCUPANT.PICKPOSTURE

**Element Attributes:**

Oracle	SAS	
1	0	Normal posture
2	1	Kneeling or standing on seat
3	2	Lying on or across seat
4	3	Kneeling, standing or sitting in front of seat
5	4	Sitting sideways or turned
6	5	Sitting on a console
7	6	Lying back in a reclined seat position
8	7	Bracing with feet or hands on a surface of the vehicle
9	8	In the lap of another occupant
10	9	Sharing a seat-sitting side by side
11	10	In a child seat
80	88	Other posture (specify):
99	99	Unknown

**Source:** Primary source is interviewee; secondary sources include vehicle inspection, police report, or official records (*i.e.*, medical).

**Remarks:**

This variable is designed to capture those instances where an occupant was not in the usual upright, **forward facing seated position** except for occupants correctly seated in child safety seats.

The occupant's posture is assessed as the last known position that the occupant was in just prior to impact. If the occupant cannot recall his/her position just prior to impact, then assign the last known position just prior to recognizing an impending danger.

The posture of an occupant of a seat or a child safety seat is normal if the occupant is correctly seated in the seat as designed. If the occupant is not seated (*i.e.*, kneeling or standing) in the child safety seat as designed, then the occupant's posture is abnormal and **Other abnormal posture** is used.

It is extremely important in locating injuries associated with various items within the passenger compartment to know as much as possible about the occupant's trajectory or path inside the vehicle

during the collision. The accuracy of this analysis depends on knowing exactly where the occupant was before the collision. Therefore, details about the occupant's posture are necessary.

As an example, if the right front passenger was sitting sideways in the seat facing the driver immediately prior to a frontal collision, it is reasonable to assume that his injuries would be confined to the right side of his body from contact with the instrument panel area. If he is reported simply as "sitting on the seat", his normal position would be with his right toward the door. For the same collision situation described above he would probably then contact the instrument panel with the front of his body rather than the side.

**Kneeling or standing on seat**

is used whenever an occupant is not seated but is kneeling or standing on a seat.

**Lying on or across seat**

is used whenever an occupant is not seated but is lying with body, or body and legs across one or more seating positions.

**Kneeling, standing or sitting in front of seat**

is used whenever an occupant is not seated but is on the floor kneeling, standing, or sitting in front of a seat, which may be occupied.

**Sitting sideways or turned**

is used whenever an occupant is seated but is sitting sideways or turned to talk with another occupant or to look out a rear window just prior to impact.

**Sitting on a console**

is used whenever an occupant is not in a seat position but is sitting on a console.

**Lying back in a reclined seat position**

is used whenever an occupant in a seat position has reclined the seat back rearward and is lying back in the seat.

**Bracing with feet or hands on a surface of the vehicle**

is used whenever a seated occupant has assumed a position of bracing on any surface of the vehicle (not including the steering wheel for the driver) just prior to the collision.

**Sitting on or in the lap of another occupant**

is used whenever two occupants occupy the same seat position by sitting on, or in the lap of, the other occupant.

**Sharing a seat-sitting side by side**

is used when a seated occupant is in the same seating location as another occupant but is not in their lap. Both occupants are considered sharing a seat.

**Other abnormal posture (specify)**

includes but is not limited to:

- sitting normally (not kneeling, etc.) in a designed rearward or side-facing seat except for occupants correctly seated in child safety seat
- leaning over in the seat
- being in an enclosed area that does not have designated seating positions
- being in an unenclosed area
- incorrectly seated in a child safety seat

**Unknown**

if the occupant's posture cannot be determined.

**OCCUPANT'S ROLE**

**Screen Name:** Role

**SAS Data Set:** *OA*

**SAS Variable:** *ROLE*

**Oracle Name:** *OCCUPANT.PICKROLE*

**Element Attributes:**

Oracle	SAS	
1	1	Driver
2	2	Passenger
9	9	Unknown

**Source:** Primary source is interviewee; secondary source is police report.

**Remarks:**

Hit-and-run vehicles are assumed to have only one occupant (unless reliable evidence to the contrary exists), and that person is assumed to be the driver. All other persons riding in or on the vehicle are considered to be passengers.



SEAT ATTRIBUTES

Occupant Form, Case #2011-999-90157S/Vehicle # 1/Occupant #1

OCCUPANT | EJECTION | ENTRAPMENT | SEAT | AIR BAG | CHILD RESTRAINT | SEAT BELT | LOG | INJURY | INJURY CODES | REVIEW

DEFINITION | ATTRIBUTES

**Seat**

Type: [Dropdown]

Orientation: [Unknown] [Dropdown]

Track: [Unknown] [Dropdown]

Performance: [Unknown] [Dropdown]

Integrated Restraints: [No] [Dropdown]

**Head Restraint**

Type: [Dropdown]

Damage: [Dropdown]

Active: [Dropdown]

Rollover Protection:

Seat Location: [11]

**Seat Back Position**

Prior: [Unknown] [Dropdown]

Post: [Unknown] [Dropdown]

**Air Bag**

Ever Available: [No] [Dropdown]

[Save] [Close]

**Remarks:**

Attributes tab information will roll over from the completed Safety Systems Form except for Seat Back Position Post and Child Restraint Used variables.

## SEAT TYPE

Page 1 of 4

Screen Name: Seat – Type

SAS Data Set: OA

SAS Variable: SEATTYPE

Oracle Name: SEATLOC.PICKSEATTYPE

## Element Attributes:

Oracle	SAS	
1	0	Occupant not seated or no seat
2	1	Bucket
3	2	Bucket with folding back
4	3	Bench
5	4	Bench with separate back cushions
6	5	Bench with folding back(s)
7	6	Split bench with separate back cushions
8	7	Split bench with folding back(s)
9	8	Pedestal ( <i>i.e.</i> , column supported)
10	9	Box mounted seat ( <i>i.e.</i> , van type)
11	10	Other seat type (specify)
13	11	Stowed/Removed
12	99	Unknown seat type/location

**Source:** Primary source is the vehicle inspection, secondary sources include: interviewee; police report, or official records (*i.e.*, medical).

**Range:** 0-11, 99

**Remarks:**

This variable assesses the type of seat present at each position. Because the type of seat may have an effect on occupant kinematics, the type of seat is important to analysts.

The term “folding back(s)” refers to seat backs that are designed to fold significantly forward of upright. These seats usually fold forward to allow easier access to the area behind the seat for egress, ingress and cargo. Seats that recline only rearward are not considered to be folding backs. Folding backs, because of the additional possibility of malfunction of the folding mechanism, take precedence over solid or separate back cushions. “Folding back(s)” is not selected if only the lower part of the seat back folds forward (for an armrest, console or trunk access). If a center seat back is separate from the outboard seat backs and folds forward for an armrest or console (in many light truck type vehicles), it is not coded as a folding back.

If a seat was folded down at the time of inspection, record the data as if the seat was in the upright position.

If a seat was removed or stowed prior to the crash, the seat position will be defined. But, no seat or safety restraint systems except air bag data will be coded for that position. A seat is considered stowed if the seat back and bottom move in the act of stowing.

The first row seats in two-door vehicles will usually have folding backs. The first row seats in four-door vehicles will usually not have folding backs.

**Bucket**

A bucket seat is a standalone seat intended for a single occupant, and shares no seatback hardware or cushion with any other seating position. Its bottom anchorage or track is attached directly to the vehicle floor, and is also not shared with any other seating position.

**Bucket with folding back**

A seat may be coded with this attribute if it meets the definition of a bucket seat and also has a seatback that folds forward.

**Bench**

A bench seat is intended for multiple occupants, has a single-piece cushion, and a single-piece seatback.

**Bench with separate back cushions**

Seats may be coded with this attribute if they have a bench type cushion, and have multiple unconnected seatbacks, and the seatbacks do not fold forward.

**Bench with folding back(s)**

Seats may be coded with this attribute if they have a bench type cushion and have single-piece or multiple-piece seatbacks which fold forward.

**Split bench**

A split bench is a bench seat, the cushion of which is divided into two or more unconnected pieces.

**Split bench with separate back cushions**

Seats may be coded with this attribute if they have a split-bench type cushion, and have multiple unconnected seatbacks, and the seatbacks do not fold forward.

**Split bench with folding back(s)**

Seats may be coded with this attribute if they have a split-bench type cushion, and have single-piece or multiple-piece seatbacks which fold forward.

**Box mounted seat (i.e. van type)**

Identifies elevated seats that are attached to a box that is fastened to the floor. The seat tracks are bolted to the top of the box. This type of seat is often found in the front row of vans.

**Pedestal (i.e. column supported)**

Pedestal seats are often found in vans and may have a swivel mechanism.

**Examples** of some seat types and the appropriate attributes:

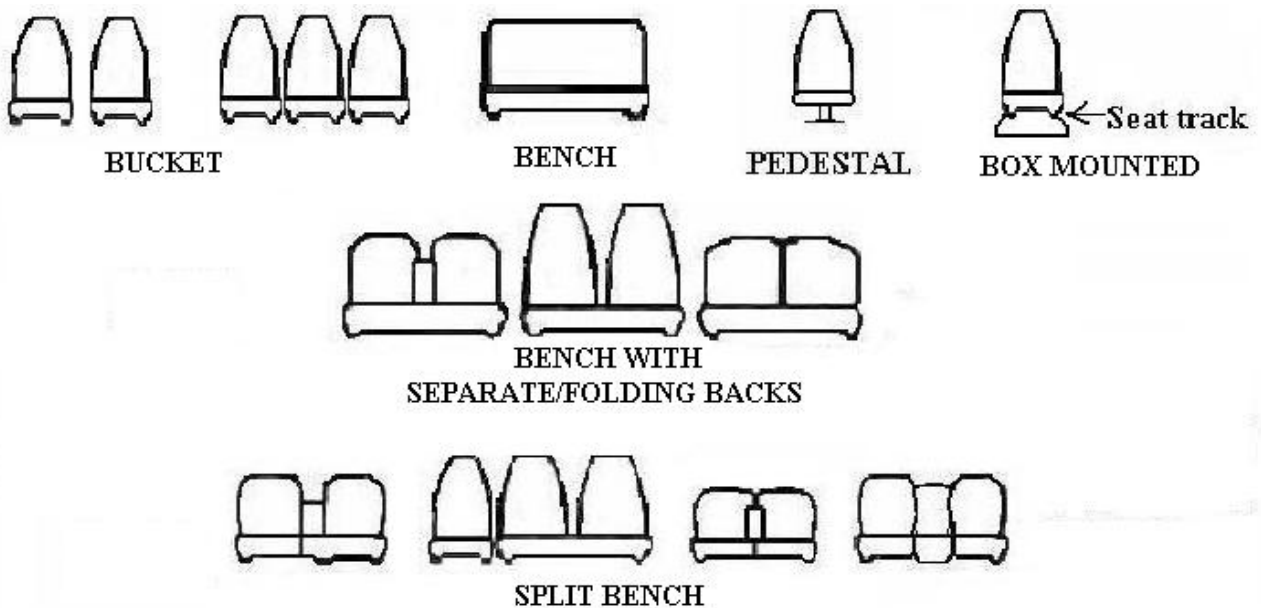

**Stowed/Removed**

A seat is considered stowed if the seat back and bottom both move during the act of stowing.

**Unknown**

Unknown will be coded if a seat was present for the crash but is unavailable for inspection.

BUCKET SEATS



BENCH SEATS

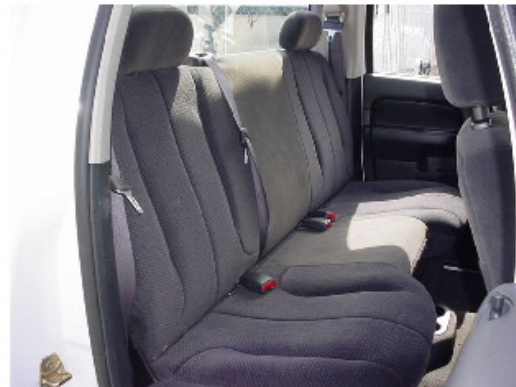

SPLIT BENCH SEATS



**Screen Name:** Seat—Orientation

**SAS Data Set:** *OA*

**SAS Variable:** *STORIENT*

**Oracle Name:** *SEATLOC.PICKSEATORIENTATION*

**Element Attributes:**

Oracle	SAS	
		[Not Applicable]
	0	[Occupant not seated, no seat]
1	1	Forward facing seat
2	2	Rear facing seat
3	3	Side facing seat (inward)
4	4	Side facing seat (outward)
5	8	Other (specify):
6	9	Unknown

**Source:** Primary source is the vehicle inspection, secondary sources include: interviewee; police report, or official records (*i.e.*, medical).

**Remarks:**

Most seats are fixed in terms of their orientation within the vehicle; however, some seats (*e.g.*, swivel or reversible) can be oriented in more than one direction. Swivel seats and reversible seats (*e.g.*, some station-wagons or vans) are entered according to their orientation at the time of impact [*i.e.*, **Forward facing seat** or **Rear facing seat**].

**Forward facing seat**

is used when the seat is oriented towards the front plane of the vehicle.

**Rear facing seat**

is used when the seat is oriented towards the rear plane of the vehicle.

**Side facing seat (inward)**

is used when the seat is oriented towards either the right or left planes of the vehicle and faces inward.

**Side facing seat (outward)**

is used when the seat is oriented towards either the right or left planes of the vehicle and faces outward.

Seat Orientation (cont'd)

Page 2 of 2

**Other**

is used when a seat is oriented such that the above attributes do not apply.

**Unknown**

is used when the seat orientation cannot be determined.

**SEAT TRACK POSITION**

**Screen Name:** Seat—Track

**SAS Data Set:** OA

**SAS Variable:** SEATRACK

**Oracle Name:** SEATLOC.PICKTRACKPOSITION

**Element Attributes:**

Oracle	SAS	
		[Not Applicable]
	0	[Occupant not seated, no seat]
1	1	Non-adjustable seat track
2	2	Seat at forward most track position
3	3	Seat between forward most and middle track positions
4	4	Seat at middle track position
5	5	Seat between middle and rear most track position
6	6	Seat at rear most track position
7	9	Unknown seat track position

**Source:** Researcher determined--Vehicle inspection, interviews confirming or secondary source.

**Remarks:**

The researcher should attempt to determine the seat position at impact. When the researcher begins the interior inspection, he/she should note the position of the seat. The researcher should then move the seat forward and back along its track and determine the number of positions. Once this has been done, the seat should be moved to the position initially observed and photographed.

If the seat has electric adjusters with no distinct track positions, attempt to determine the relative position of the seat and select accordingly.

**Non-adjustable seat track**

Use this for seats that cannot be moved longitudinally.

**Adjustable Seat Track**

**Seat at forward most track position**

Use this if the seat is at the forward limit of the track.

**Seat between forward most and middle track position**

Use this if the seat is at any position between the most forward and middle seat positions.



**Seat at middle track position**

Use this if the seat is in the position mid-range between the forward and rear most track position.

**Seat between middle and rear most track position**

Use this if the seat is at any position between the middle and rearmost track position.

**Seat at rear most track position**

Use this attribute if the seat is at the rear limit of the track.

**Unknown**

Use this attribute if the seat position at impact cannot be determined.

## SEAT PERFORMANCE

Page 1 of 3

**Screen Name:** Seat—Performance

**SAS Data Set:** OA

**SAS Variable:** SEATPERF

**Oracle Name:** SEATLOC.PICKSEATPERFORMANCE

**Element Attributes:**

Oracle SAS

		[Not Applicable]
	0	[Occupant not seated, no seat]
1	1	Seat assembly intact
2	2	Seat adjuster mechanism separated/deformed
3	3	Seat back folding locks or seat back structure separation (specify)
4	4	Seat tracks/anchors separated/deformed
5	5	Deformed by occupant of this seat
6	6	Deformed by passenger compartment intrusion (specify)
10	10	Deformed by Cargo
11	11	Deformed by Other Occupant
7	7	Combination of above (specify)
8	98	Other (specify)
9	99	Unknown

**Source:** Primary source is the vehicle inspection, secondary sources include: interviewee; police report, or official records (*i.e.*, medical) for verification.

**Remarks:**

This variable assesses the performance of the seat. The attributes are indications of whether the seat malfunctioned or was deformed in any way. Select the attribute which corresponds to the appropriate seat performance malfunction or deformation. Minor smudges, scrapes, dents, etc. are not considered deformation. If a malfunction or deformity occurs, then document the malfunction or deformation with a diagram and explanation. In addition, include photographs of the seat malfunction or deformity.

**Seat assembly intact**

is used if the seat was not deformed or no portion of the seat structure separated during the crash.

**Seat adjuster mechanism separated/deformed**

is used if any of the mechanisms used to adjust a seat's "comfort" position are separated or deformed during the crash as a result of occupant loading.

Seat adjuster mechanisms include:

- Height adjustment
- Longitudinal (horizontal) seat track adjustment
- Rocker adjustment
- Swivel/rotational adjustment
- Seat back recliner adjustment

For a seat back recliner separation, the seat back must have released in a rearward direction. Do not use this attribute if the seat back moved in a forward direction and the seat has a folding lock mechanism (*e.g.*, front seats in 2-door vehicles); see **Seat back folding locks or seat back structure separation** below. Be sure to include supportive written and photographic documentation to support all separations/deformities.

**Seat back folding locks or seat back structure separation (specify)**

is used when the mechanism which is designed to lock the seat back in its upright position deforms or separates allowing the seat back to move forward during the collision as a result of occupant loading. "Seat back" separation refers to forward facing seats where seat back structural deformities (*e.g.*, seat back hinge points) resulted in a separation of the seat back from its anchorage points. Again, to be considered applicable for this, the seat must have separated/deformed while moving forward during the collision as a result of occupant loading.

**Seat tracks/anchors separated/deformed**

is used if the seat separates, to any degree, from a seat track during the crash. In addition, use this if the seat anchor that attaches the seat track to the floorpan separates, to any degree, during the crash. Box mounted seats are included in this if a separation occurred between the box and the floor or the box and the seat track/anchor. Seat track or anchor separations/deformities must be a result of occupant loading.

**Deformed by occupant of this seat**

is used when the seat is changed in form from its original design from occupant loading during the crash. Situations where seats are deformed and also experience mechanical separations should be identified under **Combination of above**.

**Deformed by passenger compartment intrusion**

is used when the seat is deformed or separated by intrusion of an interior vehicle component(s) or exterior vehicle component(s) into the passenger compartment.

**Deformed by Cargo**

is used when the seat is changed in form from its original design by impact from cargo during the crash. Examples of cargo: spare tire, luggage, construction equipment, tool(s), and tool box(es).

**Deformed by Other Occupant**

is used when the seat is changed in form from its original design by an occupant other than the occupant in this position, during the crash. Situations where seats are deformed and also experience mechanical separations should be identified under **Combination of Above**.

**Combination of above**

is used when any combination of the above occurs and describes multiple seat malfunctions or deformations. Seat malfunctions or deformations which are not described in the above are reported below. Seat malfunctions or deformations listed in the above take priority over others.

**Other**

is used when the only seat malfunction(s) or deformation(s) which occur are not described in the above (*e.g.*, impact forces). If a seat doesn't have a comfort recline and is broken rearward code here.

**Unknown**

is used if the seat performance cannot be determined.

**DOES THE SEAT HAVE INTEGRATED PASSENGER BELTS?**

**Screen Name:** Seat—Integrated Restraints

**SAS Data Set:** SEATLOC

**SAS Variable:** INTGREST

**Oracle Name:** SEATLOC.INTEGRATEDRESTRAINTS

**Element Attributes:**

Oracle	SAS	
		[Not Applicable]
1	1	No
2	2	Yes
3	9	Unknown if integrated

**Source:** Vehicle inspection

**Remarks:**

An integrated seat belt is incorporated into the passenger seat. It is a three point seat belt system that includes a belt having one end affixed to the seat and an opposite end mounted to a retractor secured to the seat. A seat belt latch is mounted to the belt which has a releasable and lockable buckle on the opposite side of the seat. This allows the belt to pull across the passenger lap and the other portion of the belt to cross the upper torso. The belt extends through a guide located at the top of the seat. An integrated seat belt has no pillar attachment point.

If you were to remove the seat and the restraint comes with the seat indicate “Yes”.



**HEAD RESTRAINT TYPE AT THIS OCCUPANT POSITION**

**Screen Name:** Head Restraint--Type

**SAS Data Set:** OA

**SAS Variable:** HEADTYPE

**Oracle Name:** HEADRESTRAINT.PICKHEADRESTRAINTTYPE

**Element Attributes:**

Oracle	SAS	
		[Not Applicable]
	0	[Occupant not seated, no seat]
1	1	No head restraints
2	2	Integral
4	3	Adjustable
6	4	Add-on
8	8	Other (specify)
9	9	Unknown

**Source:** Primary source is the vehicle inspection, secondary sources include: interviewee; police report, or official records (*i.e.*, medical).

**Remarks:**

FMVSS 202 (Head Restraints) only applies to 1<sup>st</sup> row seating positions. Although, the presence or non-presence of head restraints are captured for all seating positions in the vehicle. Some examples of head restraint styles are shown below.

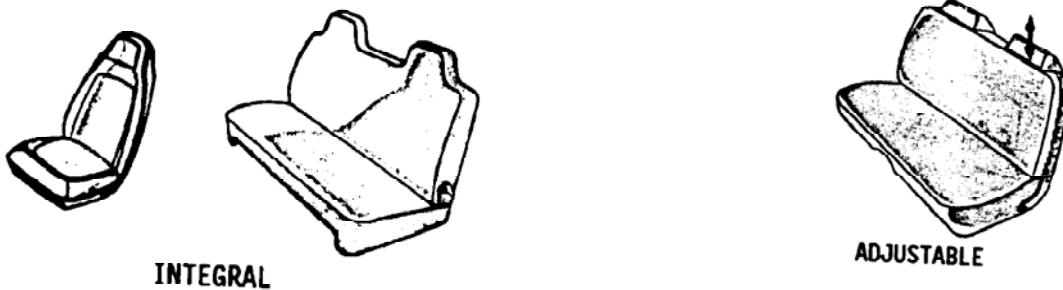

Some manufacturers are providing head restraints for rear seat occupants.

**No head restraints**

is used when (1) no head restraint is available for this seating position, or (2) there had been a head restraint but it had been removed prior to the crash.

**Integral**

refers to head restraints which are a continuous part of the seat back structure or those which are a separate structure but are not vertically adjustable. For rear seats only, if an obvious rise or sculpted head restraint is not observed, code as No Head Restraint.

**Adjustable**

applies to:

- head restraints which can be moved vertically to accommodate occupants of varying heights, **and**
- head restraints which have a fixed outer framework and a separate center section which is adjustable vertically.

**Add-on**

refer to clamp-on, strap-on, or even bolt-on head restraints on a vehicle not originally equipped with head restraints. This attribute should be infrequently used.

**Unknown**

is used when the type of head restraint cannot be determined.

**HEAD RESTRAINT DAMAGE BY OCCUPANT AT THIS OCCUPANT POSITION**

**Screen Name:** Head Restraint—Damage

**SAS Data Set:** OA

**SAS Variable:** HEADDAMG

**Oracle Name:** HEADRESTRAINT.PICKHEADRESTRAINTDAMAGE

**Element Attributes:**

Oracle	SAS	
		[Not Applicable]
	0	[Occupant not seated, no seat]
8	1	[No Head Restraints]
1	2	No damage
2	3	Damaged during crash
3	9	Unknown

**Source:** Primary source is the vehicle inspection, secondary sources include: interviewee; police report, or official records (*i.e.*, medical).

**Remarks:**

Some manufacturers are providing head restraints for rear seat occupants. These head restraints may be the same or similar to those used in the front seats, or they may be a slight rise in the rear seat back. Any damage to a rear seat head restraint by the occupant in the seat position must be captured regardless of the height of the restraint.

**No damage**

There was no damage to the head restraint by the occupant.

**Damaged during crash**

Any damage to a head restraint caused by the occupant in the seat position having the head restraint should be identified and photographed.

**Unknown**

is used when it is unknown if damage to the restraint was caused by an occupant in the appropriate seat position.



**ACTIVE HEAD RESTRAINT**

**Screen Name:** Head Restraint - Active

**SAS Data Set:** *OA*

**SAS Variable:** *HEADACT*

**Oracle Name:** *HEADRESTRAINT.ACTIVERESTRAINTD*

**Element Attributes:**

Oracle	SAS	
		[Not Applicable]
	0	[Occupant not seated, no seat]
0	1	None Present
2	2	Present
3	9	Unknown

**Source:** Vehicle Inspection, interview

**Remarks:**

There should be a label on the seat indicating the presence of the active head restraint.

**ROLLOVER PROTECTION**

**Screen Name:** Rollover Protection

**SAS Data Set:**

**SAS Variable:**

**Element Attributes:**

Check Box

Oracle	SAS	
0	0	No/Unknown (unchecked)
1	1	Yes (checked)

**Range:**

**Source:** Vehicle inspection, researcher determined

**Remarks:**

The purpose of this variable is to determine if the vehicle's rollover protection system was actuated.

Different types of systems are being used by manufacturers, also different names are used (i.e., Rollover Protection Systems (ROPS) or (RPS)). In the event of a crash that induces a certain amount of inclination roll-over sensors activate roll-bars that are integrated in or behind the seats, ensuring there is sufficient clearance for occupant's heads in the event of a crash. Also, an independent module behind each of the two rear-seat passengers' heads could deploy. A rollover need not occur for the rollover protection system to actuate.

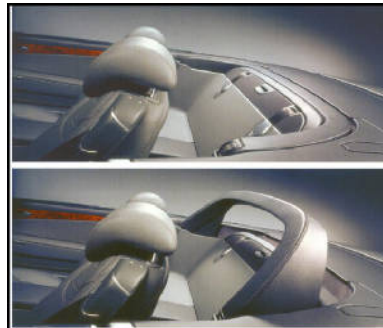

**SEAT BACK INCLINE PRIOR TO IMPACT****Screen Name:** Seat Back Position – Prior**SAS Data Set:** *OA***SAS Variable:** *STPRINCL***Oracle Name:** *SEATLOC.PICKPRIORINCLINE***Element Values:**

Oracle	SAS	
		[Not Applicable]
	0	[Occupant not seated, no seat]
1	1	Not adjustable
2	2	Upright
3	3	Slightly reclined
4	4	Completely reclined
9	9	Unknown

**Source:** Researcher determined--driver/occupant interview and vehicle inspection when the seat back incline position prior to impact can be determined from the vehicle inspection.**Remarks:****This variable is for adjustable (reclining) seat back only.****Not adjustable**

is used for seating positions where there is a seat back which is fixed in position.

**Upright**

is used when the seatback is in the fully upright position (i.e., perpendicular to the seat cushion).

**Slightly reclined**

is used when the seat back is in a slightly reclined position.

**Completely reclined**

is used when the seat back is in a position that is rearward to the limit of its range of movement.

**Unknown**

is used when the pre-impact seat back position could not be determined from any source.

**SEAT BACK INCLINE POSITION POST IMPACT**

**Screen Name:** Seat Back Position -- Post  
**SAS Data Set:** OA  
**SAS Variable:** STPSINCL  
**Oracle Name:** SEATLOC.PICKPOSTINCLINE

**Element Attributes:**

Oracle	SAS	
		[Not Applicable]
	0	[Occupant not seated, no seat]
	01	[Not adjustable]
1,8	11,21	Moved to completely rearward position
2,9,16	12,22,32	Moved to rearward midrange position
3,17	13,33	Moved to slightly rearward position
4,10,15	14,23,31	Retained pre-impact position
11,18	24,34	Moved to upright position
5,12,19	15,25,35	Moved to slightly forward position
6,20,13	16,36,26	Moved to Forward midrange position
7,14,21	17,27,37	Complete forward position
22	99	Unknown

**Source:** Researcher determined--driver/occupant interview and vehicle inspection when the seat back incline position post impact can be determined from the vehicle inspection.

**Remarks:**

This variable is for adjustable (reclining) seat backs only. This variable reflects the change in the seat back incline position as a result of forces upon it during the crash sequence. Select the attribute that describes the backrest position post-impact as a result of these forces.

**Unknown**

is used when the post crash seat back position could not be determined.

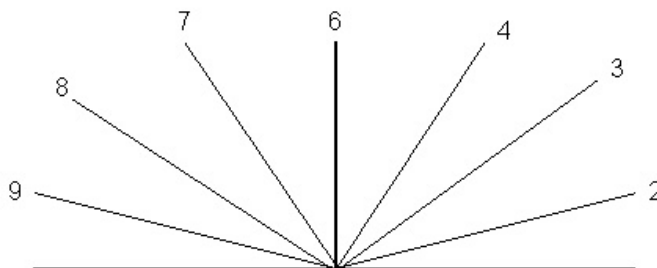

**AIR BAG EVER AVAILABLE**

**Screen Name:** Air Bag Ever Available

**SAS Data Set:** *OA*

**SAS Variable:** *BAGAVAIL*

**Oracle Name:** *SEATLOC.AIRBAGAVAIL*

**Element Attributes:**

Oracle	SAS	
1	0	No
2	1	Yes
3	9	Unknown

**Source:** Researcher determined — primary source is the vehicle inspection; secondary sources include the interview and medical records.

**Remarks:**

This variable indicates whether there was ever an air bag present of any type for this seating location. Additional information about the availability or non-availability is coded on the **Air Bag Tab**.

AIR BAG FUNCTION

Occupant Form, Case #2007-996-900015/Vehicle # 2/Occupant #1

OCCUPANT | EJECTION | ENTRAPMENT | SEAT | AIR BAG | CHILD SEAT | SEAT BELT | INJURY | INJURY CODES | LOG | REVIEW

FUNCTION | DAMAGE | EVALUATION

Location [dropdown]  
Status [dropdown]  
Type Of Air Bag [dropdown]  
System Deployment [dropdown]  
Indications of Failure [dropdown]  
Switch Type [dropdown]  
Switch Status [dropdown]

Seat Location [dropdown] Air Bag [input] of [input]  View Sketches [navigation buttons]

[Save] [Close]

**Remarks:**

Airbag Function and Damage Tabs roll over from Safety Systems Air Bag Tabs. The Air Bag Evaluation Tab is completed in the Occupant Form.

When the vehicle inspection is not completed and there is known air bag information from the interview, the air bag information is completed in the Occupant Form.

**[AIR BAG NUMBER FOR THIS VEHICLE]**

**Screen Name:** Air Bag

**SAS Data Set:** *AIRBAG*

**SAS Variable:** *BAGNO*

**Oracle Name:** *AIRBAG.AIRBAGNUM*

**Element Attributes:**

Air bag number

**Source:** Vehicle inspection

**Remarks:**

**Assigned by the system, one for every single air bag.**

If air bags are available for the occupant, indicate the information on all air bags. Do so by inserting another air bag. To insert another air bag use the menu bar and select Edit/Insert, then indicate its location, and complete the information about the air bag.

**LOCATION OF AIR BAG**

**Screen Name:** Location

**SAS Data Set:** AIRBAG

**SAS Variable:** BAGLOC

**Oracle Name:** AIRBAG.PICKLOCATION

**Element Attributes:**

Oracle	SAS	
1	1	Steering Wheel Hub
2	2	Top Instrument Panel
3	3	Mid Instrument Panel
4	4	Bottom Instrument Panel
5	5	Seat Back
8	6	Door/Panel
9	7	Roof Side Rail
6	8	Seat Belt
10	98	Other (specify)
11	99	Unknown

**Source:** Researcher determined: primary source; vehicle inspection, secondary source; interview

**Remarks:**

Enter the location of the air bag. If air bags are available for the occupant, indicate the information on all air bags. Do so by inserting another air bag. To insert another air bag go to the menu bar and select **Edit/Insert**, then indicate its location, and complete the information about the air bag.

**Steering Wheel**

is used for an air bag that is designed to deploy from a module integrated with the steering wheel. It is designed to protect the vehicle’s driver primarily from frontal impacts. Does not matter is the steering wheel is located on the right side of the vehicle, still code the location of the air bag to the steering wheel.

**Top Instrument Panel**

is used for those air bags that deploy rearward from a location on the top of the instrument panel. They are designed to protect front seat passengers primarily from frontal impacts.

**Mid Instrument Panel**

is used for those air bags that deploy rearward from a location in the middle of the instrument panel. They are designed to protect front seat passengers primarily from frontal impacts.



**Bottom Instrument Panel**

is used for those air bags that deploy rearward from a location in the bottom of the instrument panel. They are designed to protect front seat passengers primarily from frontal impacts. This includes “knee bags”.

**Seat Back**

is located on the outside portion of the seat back and is designed to protect the torso of occupants primarily from side impacts.

**Seat Cushion**

is located on the outside portion of the seat cushion and is designed to protect the torso of occupants primarily from side impacts.

**Pillar (A or B)**

is primarily a tubular shaped bag that is tethered at the A pillar and is stored in the roof side rail and is designed to protect the head of occupants primarily from side impacts

**Door/Panel**

is located in the door is designed to protect the torso of occupants primarily from side impacts. Included in this attribute are air bags that deploy from any side panels.

**Roof Side Rail**

is primarily a curtain type bag that is stored in the roof side rail and is designed to protect the head of occupants primarily from side impacts.

**Seat Belt**

is used for “air belts.” The “air belts” are designed to deploy from seat belts, allowing the forces of the crash to be spread over a larger area of the body.

**Other (specify)**

is used when the location of the air bag cannot be captured in the above attributes. This should be a rare occurrence. The location of the air bag must be specified.

**AIR BAG STATUS**

**Screen Name:** Status

**SAS Data Set:** *AIRBAG*

**SAS Variable:** *BAGFUNC*

**Oracle Name:** *AIRBAG.PICKAIRBAGFUNCTION*

**Element Attributes:**

Oracle	SAS	
1	1	Air Bag Available
2	2	Air bag disconnected (specify):
3	3	Air bag not reinstalled
4	9	Unknown status if available for this crash

**Source:** Researcher determined-- , primary source is vehicle inspection, secondary sources include interview, repair facilities, tow facility, medical records.

**Remarks:****Air bag available**

is used when the vehicle is equipped with an air bag for this seating position. Non-deployment of the air bag system has no bearing on this variable.

**Air bag disconnected**

is used when any component of the air bag was rendered inoperative prior to the collision (e.g., fuse removed).

**Air bag not reinstalled**

is used when the air bag for this seating position was not replaced after a prior deployment to the crash being researched.

**Unknown**

is used when it cannot be ascertained whether an air bag was available at the time of the crash.

**TYPE OF AIR BAG****Screen Name:** Type Of Air Bag**SAS Data Set:** *AIRBAG***SAS Variable:** *BAGTYPE***Oracle Name:** *AIRBAG.PICKAIRBAGCLASSID***Element Attributes:**

Oracle	SAS	
1	1	Original manufacturer install
3	3	Replacement Air Bag
2	2	Retrofitted Air Bag
-8871	70	[No air bag available for this crash (disconnected/not reinstalled)]
	79	[Unknown status if air bag available for this crash]
4	99	Unknown Type

**Source:** Researcher determined—primary source is the interview, secondary sources may include the repair facility and documents found in the vehicle.**Remarks:****Original manufacturer install**

is used when it can be determined that the vehicle was equipped with an air bag system in this seating position that was installed by the manufacturer at the time the vehicle was built (OEM—Original Equipment Manufacturer).

**Replacement air bag**

is used when it can be determined that the vehicle was equipped with an OEM air bag system for this seating position and that this system had been replaced due to a previous deployment.

**Retrofitted air bag**

is used when it can be determined that the vehicle was equipped with an air bag system for this seating position but that the vehicle was not built with a manufacturer equipped air bag system. This is an after market product and should not be confused with Replacement Air Bag. Replacement Retrofit Air Bags are also included in this category.

**Unknown type**

With no interview or other confirming source, assume that the type of air bag is unknown.

**AIR BAG DEPLOYMENT**

**Screen Name:** System Deployment

**SAS Data Set:** AIRBAG

**SAS Variable:** BAGDEPLY

**Oracle Name:** AIRBAG.PICKAIRBAGDEPLOY

**Element Attributes:**

Oracle	SAS	
1	1	Deployed during crash (as a result of impact)
2	2	Deployed inadvertently just prior to crash
3	3	Deployed, detail unknown
4	4	Non-collision deployment
6	7	Nondeployed
-8871	70	[No air bag available for this crash (disconnected/not reinstalled)]
-8870	79	[Unknown status if air bag available for this crash]
5	99	Unknown if deployed

**Source:** Researcher determined-- , primary source is vehicle inspection, secondary sources include interview, repair facilities, tow facility, medical records.

**Remarks:**

Although rarely occurring, an air bag may partially deploy. These air bags should be coded under **Deployed during crash.**

**Deployed during crash (as a result of impact)**

is used when the vehicle is equipped with an air bag and the air bag deployed (or partially deployed) as a result of an impact which produced a longitudinal deceleration through the vehicle of sufficient magnitude to cause inflation of the air bag. Note, an air bag is not designed to deploy in every collision.

**Deployed inadvertently just prior to crash**

is used when an air bag deploys without an impact having caused its deployment, and the vehicle is subsequently involved in a crash.

**Deployed, crash details unknown**

is used when the researcher cannot determine if the air bag deployed (1) prior to the crash or (2) during the crash as a result of an impact which produced a deceleration through the vehicle of sufficient magnitude to cause inflation of the air bag.

**Non-collision deployment**

is used if the air bag deploys during a crash but not as a result of an impact.

For example, the air bag deploys due to a vehicular fire, occurring as a result of:

- an impact
- or**
- a noncollision event

prior to any impacts to this vehicle.

**Unknown if deployed**

is used when it is known that the vehicle was equipped with an air bag but the researcher is unable to determine if the air bag deployed (for whatever reason). For example, if the vehicle was sufficiently damaged so that a determination of deployment cannot be made from the vehicle inspection or the deployment status at the time of the crash cannot be determined.

**Non-deployed**

is used when an air bag equipped vehicle has one or more impacts, and the air bag did not inflate during the crash.

**INDICATIONS OF AIR BAG MALFUNCTION**

**Screen Name:** Indications of Malfunction

**SAS Data Set:** *AIRBAG*

**SAS Variable:** *BAGFAIL*

**Oracle Name:** *AIRBAG.PICKAIRBAGFAILURE*

**Element Attributes:**

Oracle	SAS	
1	0	No
2	1	Yes (specify):
-8871	70	[No air bag available for this crash (disconnected/not reinstalled)]
-8870	79	[Unknown status if air bag available for this crash]
3	99	Unknown

**Source:** Researcher determined-- primary source is vehicle inspection, secondary sources include interview, repair facilities, tow facility, medical records.

**Remarks:**

This variable flags "indications of air bag malfunctions" and means that something abnormal has occurred to the air bag system. It may not necessarily mean that the air bag system was defective.

A vehicle inspection is required in order to report an indication of air bag malfunction because the vehicle's deceleration may have been below the *threshold* for the air bag's deployment.

**No**

is used whenever the air bag deployed and there are no indications of an air bag malfunction. Also use this when an air bag did not deploy and no malfunction is suspected and the vehicle inspection indicates that the deceleration sustained by the vehicle was near or below the *deployment threshold*.

**Yes, specify**

is used whenever an indication of an air bag malfunction is suspected and specify the malfunction. An indication of an air bag malfunction could be a blowout of the fabric, a rupture along a fabric seam, a cover which does not open properly causing a misaligned deployment, partial inflation, or any number of other problems. If an indication of an air bag malfunction is suspected, then document the condition with images, then call your zone center for assistance.

**Unknown**

is used when it is not known if the bag malfunctioned.

**TYPE OF CUTOFF SWITCH**

**Screen Name:** Switch Type  
**SAS Data Set:** AIRBAG  
**SAS Variable:** SWITCHTYP  
**Oracle Name:** AIRBAG.SWITCHTYPE

**Element Attributes:**

Oracle	SAS	
0	0	None present
1	1	Originally equipped
2	2	Retro fit
3	3	Switch present, type unknown
4	9	Unknown if switch present

**Source:** Researcher determined--, primary source is vehicle inspection, secondary sources include interview, repair facilities, tow facility.

**Remarks:**

This variable captures only manually operated switches, typically installed by the manufacturer. Air bag cutoff switches were designed to be installed by manufacturers in vehicles with only one row of occupant seating. This was done so that if a child seat was used, the air bag could be turned off. More recently NHTSA has permitted the public to request air bag cutoff switches to be installed by dealers. The retro fit switch can be located in the glove compartment. **Close up images of the switch are required.**

**None**

is used when there is no air bag cutoff switch present for this occupant position.

**Originally equipped**

is used when a vehicle is originally equipped by the manufacturer with an air bag cutoff switch for this occupant position is present. This switch will not be present for the driver’s position.

**Retro fit**

is used when an air bag cutoff switch for this occupant position has been added.

**Switch present, type unknown**

is used when an air bag cutoff switch for this occupant position is present and it is not known if it is original or retro fit.

Type of Cutoff Switch (cont'd)

Page 2 of 2

**Unknown if switch present**

is used when it is not known if an air bag cutoff switch is present.



**CUTOFF SWITCH POSITION STATUS**

**Screen Name:** Switch Status

**SAS Data Set:** AIRBAG

**SAS Variable:** SWITCHSET

**Oracle Name:** AIRBAG.SWITCHSTATUS

**Element Attributes:**

Oracle	SAS	
0	0	Switch on/automatic
1	1	Switch off
4	7	[None present]
3	8	[Unknown if switch present]
2	9	Switch status unknown

**Source:** Researcher determined--, primary source is vehicle inspection, secondary sources include interview, repair facilities, tow facility.

**Remarks:**

Air bag cutoff switches were designed to be installed by manufacturers in vehicles with only one row of occupant seating. This was done so that if a child seat was used, the air bag could be turned off. NHTSA has permitted the public to request air bag cutoff switches to be installed by dealers. The retro fit switch can be located in the glove compartment. **Close up images of the switch are required.**

**Switch on/automatic**

is used when an air bag cutoff switch for this occupant position is present and is in the on position.

**Switch off**

is used when an air bag cutoff switch for this occupant position is present and is in the off position. The switch manually rendered the air bag inoperative.

**Switch status unknown**

is used when an air bag cutoff switch for this occupant position is present and its position is unknown.

**None present**

is precoded when there is no air bag cutoff switch present for this occupant position.

**Unknown if switch present**

is precoded when it is not known if an air cutoff switch is present.

AIR BAG/DAMAGE

Occupant Form, Case #2008-903-90000S/Vehicle # 1/Occupant #1

OCCUPANT | EJECTION | ENTRAPMENT | SEAT | AIR BAG | CHILD SEAT | SEAT BELT | INJURY | INJURY CODES | REVIEW | LOG

FUNCTION | DAMAGE | EVALUATION

Module Cover Flap Open At Tear Pts

Module Cover Flap Damaged

Damage to Air Bag

Source of Damage

Seat Location  Air Bag 2 of 2  View Sketches

Save  Close

**DID AIR BAG MODULE COVER FLAP(S)/SEAM(S) OPEN AT DESIGNATED TEAR POINTS?**

**Screen Name:** Module Cover Flap Open at Tear Pts?

**SAS Data Set:** AIRBAG

**SAS Variable:** BAGFLOPN

**Oracle Name:** AIRBAG.PICKCOVERFLAPSOPEN

**Element Attributes:**

Oracle	SAS	
1	0	No
2	1	Yes
-8885	60	[Air bag did not deploy]
4	69	[Unknown if air bag deployed]
-8871	70	[No air bag available for this crash (disconnected/not reinstalled)]
-8870	79	[Unknown status if air bag available for this crash]
3	99	Unknown flaps/seams opened at tear points

**Source:** Vehicle inspection.

**Remarks:**

A designated tear point is a weakened area of the flap material designed to allow the air bag easy escape from its storage area during deployment. Some air bags in the seat cushion and seat back may not have cover flaps, but will deploy through a seam that separates during the air bag deployment.

**No**

is used when it can be determined that the module cover flap(s)/seam(s) for this air bag opened somewhere other than their designated tear points. A non-linear tear in the flap is an indication that the flap opened irregularly, not at the designated tear point.

**Yes**

is used when it can be determined that the module cover flap(s)/seam(s) for this air bag opened up at their designated tear points. Linear and symmetrical tears are good indications of proper separation of the cover flap(s) at their designated tear points.

**Unknown if flaps/seams opened at tear points**

is used when it is not known if the air bag opened at the tear points.

**WERE THE COVER FLAP(S) DAMAGED**

**Screen Name:** Module Cover Flap Damaged

**SAS Data Set:** AIRBAG

**SAS Variable:** BAGFLDAM

**Oracle Name:** AIRBAG.PICKCOVERFLAPSDAMAGE

**Element Attributes:**

Oracle	SAS	
1	0	No
2	1	Yes (specify)
-8885	60	[Not Deploy]
4	69	[Unknown if deployed]
-8871	70	[No air bag available for this crash]
-8870	79	[Unknown if air bag available for this crash]
3	99	Unknown if flaps damaged

**Source:** Vehicle inspection.

**Remarks:**

**No**

is used when it can be determined that no damage was present on the air bag module cover flap(s). Normal separation/tearing at the designated tear points does not constitute damage.

**Yes (specify)**

is used when it can be determined that the air bag module cover flap(s) sustained damage. Abnormal separation/tearing at the designated tear points constitutes damage. Damage can also be cuts, tears, holes, burns, abrasions, etc.. The researcher must specify the type of damage that is being reported.

**Unknown if flaps damaged**

is used when it cannot be determined if the air bag flap(s) sustained damage.

**WAS THERE DAMAGE TO THE AIR BAG?**

**Screen Name:** Damage to Air Bag?

**SAS Data Set:** AIRBAG

**SAS Variable:** BAGDAMAG

**Oracle Name:** AIRBAG.PICKAIRBAGDAMAGE

**Element Attributes:**

Oracle	SAS	
1	0	Not damaged
<b>Yes — Air Bag Damaged</b>		
2	1	Ruptured
3	2	Cut
4	3	Torn
5	4	Holed
6	5	Burned
7	6	Abraded
97	60	[Air bag did not deploy]
11	69	[Unknown if air bag deployed]
-8871	70	[No air bag available for this crash (disconnected/not reinstalled)]
-8870	79	[Unknown status if air bag available for this crash]
8	88	Other damage (specify)
9	95	Damaged, details unknown
10	99	Deployed, unknown if damaged
-8872	96	Post crash damage

**Source:** Vehicle inspection

**Remarks:**

Damage to the air bag must occur during the crash sequence. If multiple damage types apply select the attribute that most deteriorates the effectiveness of the air bag. If you cannot make this determination then select the attribute in a hierarchical manner from the top of the list down.

**Not damaged**

is used when no damage to the air bag for this occupant position was sustained.

**Ruptured**

describes damage to the air bag that resembles a stellate or starlike pattern of damage, with multiple tears originating from a single point of origin.

Was There Damage To The Air Bag? (cont'd)

Page 2 of 2

**Cut**

describes openings in the air bag which are generally linear and have smooth edges.

**Torn**

describes openings which have ragged edges but which are generally linear in appearance.

**Holed**

describes damage which is circular in appearance with or without ragged edges. If a burn causes a hole, then select burned

**Burned**

describes damage resulting from heat which scorches, melts or burns the bag.

**Abraded**

is a pattern of damage to the surface of the bag that appears as a fraying of the surface threads.

**Other damage (specify)**

is used to describe damage which is not captured in any of the attributes above.

**Damaged, details unknown**

is used when it is known that the air bag sustained damage, but the type of damage cannot be determined.

**Deployed, unknown if damaged**

is used when cannot be determined if the air bag sustained damage.

**Post crash damage**

is used when rescue or emergency efforts caused damage to the air bag. Also, use this for damage caused by towing.

**SOURCE OF AIR BAG DAMAGE**

**Screen Name:** Source of Damage

**SAS Data Set:** AIRBAG

**SAS Variable:** BAGDAMSO

**Oracle Name:** AIRBAG.PICKSOURCEOFDAMAGE

**Element Attributes:**

Oracle	SAS	
2	1	Object worn by occupant (specify)
3	2	Object carried by occupant (specify)
4	3	Adaptive/assistive controls, (specify)
12	4	Cover flaps
5	5	Fire in vehicle
6	6	Thermal burns
14	9	Glazing
-8872	96	[Post crash damage]
1	50	[Air Bag Not Damaged]
10	59	Deployed, unknown of damaged
97	60	[Air bag did not deploy]
11	69	[Unknown if air bag deployed]
-8871	70	[No air bag available for this crash (disconnected/not reinstalled)]
-9999	79	[Unknown status if air bag available for this crash]
8	88	Other damage source (specify)
9	99	Damaged unknown source

**Source:** Vehicle inspection (with interview/medical records as confirming source for objects worn/carried by occupant)

**Remarks:**

This is a hierarchical variable, that is, if more than one element applies, then select the first attribute that applies. The attribute **Rescue or emergency efforts** should **only** be used when:

- no other sources of damage apply,  
**AND**
- it is known the damage was from rescue or emergency efforts, or any other post-crash source.

**Object worn by occupant (specify)**

is selected when the object is fastened, attached, or worn by the occupant. Be sure to specify the object.

**Object carried by occupant (specify)**

is used when the object is held in the mouth, the hand(s), arm(s), etc., by the occupant. Be sure to specify the object.

**Adaptive/assistive controls (specify)**

is used when adaptive/assistive controls damages the air bag for this occupant position. Be sure to specify the object/control.

**Cover flaps**

is used when the air bag cover flaps damaged the air bag for this occupant position.

**Fire in vehicle**

is used when there was a fire in the occupant compartment which damaged the air bag.

**Thermal burns**

is used when the air bag is burned or scorched by the inflator or chemicals.

**Other damage source (specify)**

is used whenever there is damage to the air bag and it cannot be fit into any of the categories above. Be sure to specify the object/source.

**Unknown**

is used when there is damage to the air bag, but the source of the damage cannot be determined.



AIR BAG/EVALUATION

Occupant Form, Case #2008-903-90000S/Vehicle # 1/Occupant #1

OCCUPANT | EJECTION | ENTRAPMENT | SEAT | AIR BAG | CHILD SEAT | SEAT BELT | INJURY | INJURY CODES | REVIEW | LOG

FUNCTION | DAMAGE | EVALUATION | SKETCH #1 | SKETCH #2 | SKETCH #3

Vehicle Previous Accidents [dropdown]  
Prior Maintenance/Service [dropdown]  
Event Number [dropdown]

DELTA V PDDF [input] degrees CDC [input]

Total	Longtdl	Lateral	Energy	Impact	Barrier	Estimated	Rank
[input]	[input]	[input]	[input]	[input]	[input]	[dropdown]	[input]

CDC for Deployment Impact [dropdown]

Seat Location [11] Air Bag [1] of 1  View Sketches [left] [right]

Save Close

**HAD THE VEHICLE BEEN IN PREVIOUS CRASHES?**

**Screen Name:** Vehicle Previous Crashes

**SAS Data Set:** AIRBAG

**SAS Variable:** PREVACC

**Oracle Name:** AIRBAG.PICKPRIORACCIDENT

**Element Attributes:**

Oracle	SAS	
1	1	No previous crashes
2	2	Previous crash(es) without deployment(s)
3	3	One previous crash with deployment
4	4	More than one previous crash with at least one deployment
5	8	Previous crashes, unknown deployment status
6	9	Unknown

**Source:** Researcher determined — primary source is the interview, secondary source may include a repair facility.

**Remarks:**

**No previous crashes**

is used for vehicles which are equipped with an air bag for this occupant position, and have not been involved in any previous crashes.

**Previous crash(es) without deployment(s)**

is used when it can be determined that the vehicle had been in previous crash(es) which did not involve an air bag deployment for this occupant position.

**One previous crash with deployment**

is used when it can be determined that the vehicle had been in only one previous crash and the air bag for this occupant position deployed in that crash.

**More than one previous crash with at least one deployment**

is used when it can be determined that the vehicle had been in more than one previous crash at least one of which involved an air bag deployment for this occupant position.

**Previous crashes, unknown deployment status**

is used when it can be determined that the vehicle had been in at least one previous crash, but the deployment status for this occupant position in any of these previous crashes cannot be determined.

Had the Vehicle Been in Previous Crashes? (cont'd)

Page 2 of 2

**Unknown**

is used when it cannot be determined if the vehicle had been in previous crash(es) and/or the air bag deployment status for this occupant position cannot be determined.

**HAD ANY PRIOR MAINTENANCE/SERVICE BEEN PERFORMED ON THIS AIR BAG SYSTEM?****Screen Name:** Prior Maintenance/Service**SAS Data Set:** *AIRBAG***SAS Variable:** *BAGMAINT***Oracle Name:** *AIRBAG.PICKPRIORMAINTENANCE***Element Attributes:**

Oracle	SAS	
1	1	No prior maintenance
2	2	Yes, prior maintenance (specify)
3	9	Unknown

**Source:** Researcher determined — primary source is the interview, secondary sources may include repair facilities and or documents found in the vehicle.**Remarks:**

This variable is specific for the air bag at this occupant's position.

**No prior maintenance**

is used when it can be determined that the vehicle was equipped with an air bag system, but never had any maintenance/service performed on the air bag system.

**Yes, prior maintenance, specify**

is used when it can be determined that the vehicle was equipped with an air bag system and that the system had some previous maintenance/service performed. If possible, the researcher must specify exactly what type of maintenance/service was performed and a date of service if possible.

**Unknown**

is used when it cannot be determined if the vehicle's air bag system had previous maintenance/service.

**AIR BAG DEPLOYMENT ACCIDENT EVENT SEQUENCE NUMBER**

**Screen Name:** Event Number

**SAS Data Set:** *AIRBAG*

**SAS Variable:** *BAGEVENT*

**Oracle Name:** *EVENT.EVENTSEQUENCENUMBER*

**Element Attributes:**

- Event #
- 60 [Air bag did not deploy]
- 69 [Unknown if air bag deployed]
- 70 [No air bag available for this crash (disconnected/not reinstalled)]
- 79 [Unknown status if air bag available for this crash]
- 99 Deployed, unknown event

**Source:** Primary sources are the scene and vehicle inspections; secondary sources include the police report and the interviewee.

**Range:** 1-35, 60, 69, 70, 79, 99

**Remarks:**

**Event #**

Select the event number that is directly related to the deployment for of this occupant position air bag.

**Deployed, unknown event**

is used when this air bag for this occupant position deployed, but the event associated with the deployment cannot be determined.

**CDC FOR AIR BAG DEPLOYMENT IMPACT**

**Screen Name:** CDC For Deployment Impact

**SAS Data Set:** *AIRBAG*

**SAS Variable:** *BAGCDC*

**Oracle Name:** *AIRBAG.PICKCDCIMPACTDELTA V*

**Element Attributes:**

Oracle	SAS	
1	1	Highest Delta V
2	2	Second highest Delta V
3	3	Other Delta V (specify)
7	60	[Air bag did not deploy]
5	69	[Unknown if air bag deployed]
-8871	70	[No air bag available for this crash (disconnected/not reinstalled)]
-8870	79	[Unknown status if air bag available for this crash]
4	99	Deployed, unknown event

**Source:** Researcher determined — primary sources are the scene and vehicle inspection; secondary sources are the police report and the interviewee.

**Remarks:**

It is not necessary to run a reconstruction program to code this variable. Determination of the proper code can be made by visual estimation if no other means are available.

**Highest delta V**

is used when it is determined that the crash event which is associated with the air bag deployment for this occupant position is also the event which produced the highest delta V for this vehicle.

**Second highest delta V**

is used when it is determined that the crash event which is associated with the air bag deployment for this occupant position is also the event that produced the second highest delta V for this vehicle.

**Other Delta V (specify)**

is used when it is determined that the crash event which is associated with the air bag deployment for this occupant position did not produce either the highest or second highest delta V.

**Deployed, unknown event**

is used when it cannot be determined which crash event is associated with the air bag deployment for this occupant position.

**Child Restraint Overview**

The National Automotive Sampling System (NASS) is the premier data collection system of real-world crashes and as such it is relied upon to deliver data on high profile vehicle safety components such as child restraints. Complete and thorough documentation in this area is an essential element for the agency to achieve its mission. The variables on the Safety System and Occupant forms were designed to document the usage of Child Restraint Systems (CRS) installed in towed CDS applicable vehicles involved in crashes.

Motor vehicle crashes are the leading cause of death and disability for pediatric and adolescent children, and child passenger safety has long been an agency concern. Accordingly, there continues to be a need to collect and compile data on children involved in crashes. Data collected in the past have shown that children may become out of place when they are not secured properly within a CRS. Children frequently escape the CRS' internal harness and in some instances kneel or stand on the vehicle's seat cushion instead of remaining secured in the CRS. In other cases the child is placed within the CRS; however, the caregiver improperly restrained the child and/or incorrectly secured the CRS within the motor vehicle. Historically, correct use and installation of a CRS is a highly effective means of reducing the incidence of serious injury and death to children.

Most states have attempted to address the issue of child safety in motor vehicles with legislation requiring children to be restrained within a CRS and seated in the back row(s) of vehicles. These efforts have resulted in a sharp reduction of injuries and deaths among children, but more data related to the real-world use and performance of child restraints needs to be collected annually. One past and present source of child restraint data is the Police Accident Report (PAR); however, frequently, the PAR provides inaccurate or incomplete data on the type of CRS and how the child was positioned within it.

The National Highway Traffic Safety Administration (NHTSA) enacted two Federal Motor Vehicle Safety Standards (FMVSS) related to child occupant protection; they are: No. 213, Child Restraint Systems and No.225, Child Restraint Anchorage Systems [e.g., Lower Anchors and Tethers for Children (LATCH)]. Within these standards was the requirement that the testing and performance of child restraints would be under the purview of NHTSA and all CRS and vehicle manufacturers would be required to meet these standards. NHTSA performs controlled testing of child seats in laboratories and crash test facilities, and NASS data is collected to augment this research. Analysts will compare usage, injury severity, and delta V data to assess performance levels among different child restraints. After these analyses, the existing standards will be evaluated to determine their effectiveness and whether updates are warranted. These data also assist the agency in identifying any significant problems common among any particular child restraint types.

When discovering that a child was present within a CDS applicable vehicle, the researcher should ***conduct the inspection under the presumption that a CRS was present and occupied*** during the crash. In many cases, the CRS will have already been removed by the police and/or emergency personnel and may be in the possession of the owner, the police jurisdiction, or the treating hospital/trauma center.

When the CRS is not present in the vehicle at the time of the inspection, the researcher should make continual attempts to locate and inspect the CRS. Once located, the inspection shall consist of a detailed examination of the CRS, highlighting any observable damage; the internal harness, including evidence on the webbing (stretching, transfers, burn marks, etc.); height/weight/age recommendations (recorded from labeling on the CRS shell); make/model data (also recorded from labeling on the CRS shell); and evidence within the belt paths. After recording the data, a comprehensive set of digital images shall be taken of the CRS, including any damage, and all CRS labeling.

In addition to the physical inspection of the CRS, a comprehensive interview with the parent/caregiver is vital toward understanding how the CRS was installed in the vehicle and how the child was positioned and restrained during the crash. Information, including what the child was wearing, where the chest retainer clip was positioned, the height and weight of the child and the location of the CRS within the vehicle is critical to understanding whether the CRS functioned as it was designed. Each CRS within the vehicle should be documented regardless of whether it was occupied at the time of the crash.

Some vehicles, specifically some types of minivans and sport utility vehicles, integrate a CRS into the second and third rows of the vehicle. These types of child restraints are termed *integrated child restraint systems*, and they should be documented regardless of whether the CRS was occupied at the time of the crash.



CHILD SEAT/LIST

Occupant Form, Case #2007-996-900015/Vehicle # 2/Occupant #1

OCCUPANT | EJECTION | ENTRAPMENT | SEAT | AIR BAG | CHILD SEAT | SEAT BELT | INJURY | INJURY CODES | LOG | REVIEW

LIST | DETAIL

Make	Model	Occ #	Seat

Save Close

CHILD SEAT/DETAIL

Occupant Form, Case #2011-999-90157S/Vehicle # 1/Occupant #1

OCCUPANT | EJECTION | ENTRAPMENT | SEAT | AIR BAG | CHILD RESTRAINT | SEAT BELT | LOG | INJURY | INJURY CODES | REVIEW

LIST | DETAIL

CHILD RESTRAINT | VEHICLE

Make  Occ #s

Model  Date of Manufacture

Model No  Type  How Used

Data Source

Design Feature Available		How Feature Used	
	Orientation	<input type="text"/>	<input type="text"/>
Harness/ Shield	<input type="text"/>	<input type="text"/>	<input type="text"/>
Retainer Clip	<input type="text"/>	<input type="text"/>	<input type="text"/>
Tether	<input type="text"/>	<input type="text"/>	<input type="text"/>
LATCH	<input type="text"/>	<input type="text"/>	<input type="text"/>
	Belt Routing / Use	<input type="text"/>	<input type="text"/>
	Locking Clip Use	<input type="text"/>	<input type="text"/>

Seat Location  Placement  Child Position

**[CHILD RESTRAINT NUMBER]****Screen Name:** N/A**SAS Data Set:** *CHILDSEAT***SAS Variable:** *CHSEATNO***Oracle Name:** *CHILDSEAT.CHILDSEATID***Element Attributes:**

1, 2, 3, etc.,

**Source:** As created by system**Remarks:**

**CHILD RESTRAINT MAKE****Screen Name:** Make**SAS Data Set:** *CHILDSEAT***SAS Variable:** *CHMAKE***Oracle Name:** *CHILDSEAT.CHILDSEATMAKEID***Element Attributes:**

Oracle SAS

997 Refer to listing of Child Restraints  
Other make (specify)  
-999 Unknown make

**Source:** Vehicle inspection, child safety seat inspection, interview**Remarks:**

The manufacturer/make name is usually stamped, sewn or molded onto the exterior surface of the CRS. Removal of padding from the CRS, and an examination of the shell, may be necessary to identify the make, model, serial no. and/or date of manufacture of the CRS. The CRS owner's manual, when available, is a valuable source of information and should be referred to by the researcher. The CRS should also have a label permanently attached that identifies the restraint's date of manufacture and model number; this information alone may be used to identify the specific manufacturer and make of seat if no other identifiers exist. In the absence of any other identifying information, take several digital images of the CRS. Those images, used with other resources, are helpful in identifying the make and model of the CRS at a later date. When the make of the CRS cannot be determined, the attribute **unknown make** should be selected.

**CHILD RESTRAINT MODEL**

**Screen Name:** Model  
**SAS Data Set:** *CHILDSEAT*  
**SAS Variable:** *CHMODEL*  
**Oracle Name:** *CHILDSEAT.PICKMODELID*

**Element Attributes:**

Oracle	SAS	Refer to listing of child restraints
-998		Other (specify)
-999		Unknown model

**Source:** Vehicle inspection, child safety seat inspection, interview

The manufacturer/make name is usually stamped, sewn or molded onto the exterior surface of the CRS. Removal of padding from the CRS, and an examination of the shell, may be necessary to identify the make, model, serial no. and/or date of manufacture of the CRS. The CRS owner’s manual, when available, is a valuable source of information and should be referred to by the researcher. The CRS should also have a label permanently attached that identifies the restraint’s date of manufacture and model number; this information alone may be used to identify the specific manufacturer and make of seat if no other identifiers exist. In the absence of any other identifying information, take several digital images of the CRS. Those images, used with other resources, are helpful in identifying the make and model of the CRS at a later date. When the model of the CRS cannot be determined, the attribute **unknown make** should be selected. The image below illustrates a typical CRS label.



**Date of Manufacture:** 20AUG01 (August 20, 2001)

**Model Number:** 2501176 P1

## CHILD RESTRAINT TYPE

Screen Name: Type

SAS Data Set: *CHILDSEAT*

SAS Variable: *CHTYPE*

Oracle Name: *CHILDSEAT.PICKCHILDSEATTYPE*

## Element Attributes:

Oracle	SAS	
3	3	Infant seat (ISS)
1	1	Convertible seat (CSS)
2	2	Forward facing only (FSS)
4	4	Booster seat (BSS)
10	10	Booster/Forward facing seat (BSS/FSS)
11	11	Booster/Convertible facing seat (BSS/CSS)
5	5	Integrated seat (INT)
8	8	Harness (HSS)
7	7	Vest (VSS)
6	6	Special needs (SNSS)
98	98	Other (specify)
99	99	Unknown

Source: Vehicle inspection, child safety seat inspection, interview

## Remarks:

Once the CRS has been identified by its make and model, the CRS *type* will sometimes automatically be defined. **Since this variable represents how the CRS was designed to be used,** this information should be determined during the child seat inspection and/or by asking appropriate questions during the interview. The type of CRS can be determined in the absence of the make and model names.

**Screen Name:** How Used

**SAS Data Set:** *CHILDSEAT*

**SAS Variable:** *CHHOWUSED*

**Oracle Name:** *CHILDSEAT.PICKHOWUSED*

**Element Attributes:**

Oracle	SAS	
1	1	Infant seat (ISS)
2	2	Forward facing only (FSS)
3	3	Booster seat (BSS)
4	4	Integrated seat (INT)
5	5	Harness (HSS)
6	6	Vest (VSS)
7	7	Special needs (SNSS)
98	98	Other (specify)
-99	99	Unknown

**Source:** Vehicle inspection, child safety seat inspection, interview

**Remarks:**

Since this variable represents how the CRS was actually used, this information should be determined during the child seat inspection and/or by asking appropriate questions during the interview. How the CRS was used can be determined in the absence of the make and model names.

The following seven pages outline the different types of child restraints a researcher will encounter during a crash investigation.

**Infant Safety Seat (ISS)**

Designed and intended to be used as *rear-facing only* by newborns and infants weighing up to approximately 22 pounds and are typically equipped with either a 3- or 5-point harness. Some infant seats have detachable bases which can be left secured in the vehicle while the infant seat is removed and used as a carrier. When used in the vehicle as a child restraint, the carrier-type infant seat’s carrying handle should be folded back in the down position in most cases, and the CRS should recline at a 45-degree angle (carrying handle instructions and angles vary by manufacturer).

Infant seats are typically designed with 2 or 3 sets of harness strap slots in the back of the CRS which allows for proper harness strap placement (always adjusted at or below the infant’s shoulders). Most harness adjustment mechanisms are mounted behind the seat back and affixed/locked by a metal bar, or clip-type lock. These types of child restraints are also normally equipped with a harness retainer clip that should be positioned to the infant’s armpit level. Either the vehicle’s belt system (lap or lap portion of a lap/shoulder belt) or the lower LATCH anchors must be used to secure the seat and/or its base to the vehicle.



**Common infant seat with detachable base**



**LMY infant seat**



**LMY infant seat equipped with foot brace to abut seat back**



**Convertible Safety Seat (CSS)**

Designed and intended to be used either rear or forward facing for children ranging from birth to approximately 40 pounds (usage restrictions will normally be found on the CRS labeling as well as in the owner’s manual). All convertible seats have a harness system to secure the child to the CRS. The most common system consists of a 5-point harness with a harness retainer clip that should be adjusted to the armpit level of the child. Although not as common, some child seats may have a T-shield or tray-shield. Note: T- and tray-shield designs have been phased out as manufacturers have not employed this design in several years; however, they are still being used by small numbers of people.

Most convertible seats employ three or more sets of harness slots located on the CRS seat back which are used to adjust the height of the harness; proper slot usage is based on the age and size of the child. Generally, the lowest and middle slots are used when the CRS is in a rear facing orientation and the top slots are used when the CRS is used forward-facing (the slot position requirements vary by manufacturer). Child seats used in a rear facing orientation typically range from the birth of the child up to 20 pounds. Some seats have a range that extends to as high as 40



CRS with 5-point harness



CRS with T-shield



CRS with tray-shield

pounds. Refer to the CRS labeling and the owner’s manual for the height and weight requirements for each CRS.

Either the vehicle’s lap and shoulder safety belt system or the Lower Anchors and Tethers for Children (LATCH) system must be used to secure the child seat into the vehicle. As of 2011 it was still not recommended to use both systems simultaneously. However, the top tether should be used in conjunction with either system when in a forward-facing orientation. The LATCH system can only be used when both the CRS and vehicle are equipped with LATCH attachments.

**Forward Facing Only Safety Seat (FSS)**

A forward facing only safety seat is intended to be used by children who are over one year of age and who weigh between 20 and 40 pounds. The majority of these seats are equipped with an internal harness and adjustable chest retainer clip; however, some earlier models were designed as a backless booster safety seat with an attached shield. Most forward-facing seats are equipped with three sets of harness slots that allow for the adjustment of the harness straps, at or above the shoulders, as the child grows. Forward facing only safety seats are installed in the vehicle with either the lap and shoulder belts or the LATCH system. **Note:** The top tether should be used in conjunction with the lap and shoulder belts.

The majority of forward facing only safety seats convert to belt-positioning booster safety seats by removing the internal harness after the child reaches 40 pounds. Because different child seats have different design characteristics, it is important to check the owner’s manual for slight usage variations.

Shield booster seats are considered forward facing only safety seats when the shield is used. Otherwise, they are considered booster safety seats.



**CRS equipped with internal harness and adjustable chest retainer clip**



**Shield booster seat**

**Booster Safety Seat (BSS)**

Booster safety seats elevate and position the child and they are intended to be used in a forward-facing orientation with the vehicle’s lap and shoulder restraint. There are two main types of booster seats: belt-positioning high-back booster seats and backless booster seats. Many booster seats are hybrid models equipped with detachable seat backs.

Belt-positioning high-back booster seats typically contain shoulder belt channels/positioners (circled in images) that guide the shoulder belt in the proper orientation around the child and the CRS. The head restraint area of the high-back is usually contoured in a half-moon configuration to provide added protection for the child’s head.



**Belt positioning high back(ed) booster seat**

Backless booster seats have no seat back, but they also contain belt channels/positioners under the armrests for correct belt routing. Some backless booster seats are equipped with a shield (the aforementioned shield-boosters) that is removable. Child seats are considered booster seats only if the shield is not used during the crash. Otherwise, they are considered forward facing safety seats.



**Backless booster seat**

The detachable seat back booster seat is a hybrid version of those illustrated in to the right and can be used in either manner. The latest variations of these booster seats include lower anchor LATCH anchors (outlined in image) that were uncommon to booster safety seats until 2008. The seat to the right is a LATCH equipped booster seat, widely considered the first of these new types of booster seats. The subject of LATCH is discussed in greater detail later in this (Child Restraint) section of the manual.



**LATCH equipped booster seat**

**Integrated Child Safety Seat (INT)**

Integrated child safety seats (also known as built-in child seats) are usually mounted within the seatbacks in the back rows of certain vehicles. The majority of the older models were designed for forward-facing orientation usage only for children of at least one year of age, a height of 33 – 40 inches, and a weight of 20 – 40 pounds. Most integrated seats were equipped with a 5-point internal harness system; however, many newer vehicles are equipping their vehicles with integrated booster seats for use by children who weigh up to 80 pounds. Many of the forward facing platforms are being phased out as manufacturers focus on a new generation of booster seats. The newer seats come in many different designs and it is important to check the owner’s manual for specific requirements for each integrated child restraint.



**Older 5-point harness type of integrated CRS (typically seen in many older minivans)**



**Newer booster type of integrated CRS**



**Newer booster type of integrated CRS**

**Harness (HSS)**

Harnesses are intended to be used on children in a forward facing orientation who exceed the weight and age restrictions of forward facing child seats (over 40 pounds/exceeding 5-years-old). Harnesses are comprised of two straps, connected by a chest retainer clip, that converge into one strap which is designed to affix to the top tether hook of the vehicle. The bottom edges of the straps contain loops near the seat bight for the lap belt to be routed through. The lap belt webbing rests against the child’s lap securing the lower body while the straps attach to the top tether hook and protect the torso. Although harnesses are compliant with FMVSS guidelines, they have largely been supplanted by booster seats, and are currently produced by only one manufacturer (EZ-On Products). They are rated to restrain children up to 80 pounds; however, with the installation of an aftermarket tether kit, the harness can restrain children up to 168 pounds.



**Harness**

**Travel Vests (VSS)**

Vests are designed for forward facing use only and are generally intended for use by children weighing 25 – 40 pounds. There are models that can accommodate persons from 2 years of age through adulthood and up to 168 pounds, but they are rare. Vests are comprised of similar adjustable harnesses and loops to be used in conjunction with the vehicle’s lap or lap and shoulder belt and top tethers. Some vests are designed with a 5-point internal harness and zipper activated adjusters to regulate the strap length. Some vests such as those used on special-needs school buses may require a separate aftermarket seat mount to ensure proper usage.



**Travel vest**

**Special Needs Safety Seat (SNSS)**

Special Needs seats are intended for children with special transportation needs who range from newborn to 100 pounds. The majority of these seats are designed for forward facing use only; however, some can be used in both forward and rear facing orientations. All SNSS's are configured with 3- or 5-point internal harness systems or some other internal harness configuration. Some are also equipped with belt extenders to be used in coordination with other aftermarket special needs products. These seats are usually much larger than standard forward facing child restraints.



**Special needs safety seat**

**Other, specify** (Not meant for vehicle travel)

Other child seats include all other items a person might use that are not FMVSS 213 or 225 compliant. These products may consist of seats with no labeling identifiable either through post-1990 child seat listings, manufacturer's instructions, or located within the typical literature on the subject. Persons have been known to use infant carriers, phone or other books, restaurant/home style booster seats, portable cribs/cradles, wood and plastic platforms and cushions and pillows. All of these examples would fall into the category of Other.

**Unknown**

Unknown is used when any child restraint cannot be identified. Before defaulting to this attribute all available information should be thoroughly examined (photographs, PAR statements, interview statements, CRS manuals) in an attempt to determine the CRS make, model, and type.

**OCCUPANT FORM**

**CHILD RESTRAINT/DETAIL**

**DATE OF MANUFACTURE**

**Screen Name:** Date of Manufacture

**SAS Data Set:** *CHILDSEAT*

**SAS Variable:** *MANDATE*

**Oracle Name:** *CHILDSEAT.DATEMADE*

**Element Attributes:**

Oracle SAS

MM/DD/YYYY

Indicate the date of manufacture as indicated on the child restraint

12/30/1899

99/99/9999

Unknown date

**Source:** Vehicle inspection, child restraint system inspection, interview

**Remarks:**

Indicate the manufacture date as labeled on the child restraint. This information is important in determining the model of the child restraint when it is not otherwise known. The image on the left displays the expiration date of the child restraint (**2005**) and the image on the right displays the date of manufacture (**04MAR97**), as well as the model number (**235210P2**).



**MODEL NUMBER**

**Screen Name:** Model No

**SAS Data Set:** *CHILDSEAT*

**SAS Variable:** *MODELNO*

**Oracle Name:** *CHILDSEAT.MODELNO*

**Element Attributes:**

Indicate the model number as indicated on the child restraint

**Source:** Vehicle inspection, child restraint system inspection, interview

**Remarks:**

Refer to the image on the previous page for the model number. The model number will default to capital letters.



**SOURCE OF DATA**

**Screen Name:** Source of Data

**SAS Data Set:**

**SAS Variable:**

**Oracle Name:** *CHILDSEAT.SOURCEID*

**Element Attributes:**

Oracle	SAS	
1	1	Vehicle
2	2	Interview
3	3	Vehicle and Inspection
4	4	Photographs Only
5	5	Official Records

**Source:** Researcher determined

**Remarks:**

Indicate the source of the data for the child restraint information. If the CRS is present within the vehicle at the time of the inspection, use **Vehicle Inspection**. If the CRS is inspected at the owner/driver's home, use **Interview**. If the CRS is inspected and no vehicle inspection is obtained, use **CRS Inspection Only**. Official records include medical records and police reports.

## CHILD RESTRAINT HARNESS/SHIELD DESIGN

Page 1 of 3

**Screen Name:** Harness/Shield**SAS Data Set:** *CHILDSEAT***SAS Variable:** *HARDES***Oracle Name:** *CHILDSEAT.PICKHARNESSDESIGN***Element Attributes:**

Oracle	SAS	
-8887	0	No harness/shield available (or not designed with harness/shield)
1	1	3-pt harness
2	2	5-pt harness
3	3	T-shield
4	4	Tray-shield
5	5	Shield
6	6	6-pt harness
-9999	9	Unknown

**Source:** Vehicle inspection, child restraint system inspection, interview**Remarks:**

This variable explains how the CRS is designed to be used. It does not specify how the CRS was actually used in the crash, or whether it was used as designed.

A harness is similar to a normal safety belt, but it is integrated within the CRS itself. It is designed to restrain the child within the CRS.

Specific examples of harness and shield designs are discussed on the following pages.

**3-Point Harness**

Two harness straps that cross the child's shoulders are attached to a latch plate that is inserted into a buckle on the CRS. A retainer clip is also attached to the two harness straps to be positioned to the child's armpit level. These types of harnesses are found mostly in older ISS types and are not as common in recent years.



**3-point harness**

**5-Point Harness**

These are the most common types of harness straps found in all types of child restraints. The system consists of two straps that cross the shoulders and two straps that cross the child's thighs. A two-piece chest retainer clip connects the shoulder straps and dual latch plates are inserted into the buckle on the CRS.



**5-point harness**

**T-Shield**

The harness straps are housed within a T-shaped shield that is inserted into a buckle on the CRS. The harness straps are also connected by an adjustable chest retainer clip. This is another harness system that has been largely phased out and will only be found in older models.



**T-shield**

**Tray-Shield**

The harness straps are attached to a padded tray that folds down in front of the child's torso and hips. The latch plate is inserted into the buckle on the CRS and is sometimes attached to the tray-shield or is independent. This is another harness system that has been largely phased out and will only be found in older models.



**Tray-shield**

**Shield Booster**

Shield Boosters are attached to BSS-type restraints and have an internal path for belt routing. They are designed for children up to 60 pounds when the CRS is used as a BSS. This is another type of system that has been largely phased out.



**Shield booster**

**6-Point Harness**

The 6-point harness system is very rare for child restraints. The most common type of 6-point harness is illustrated to the right.



**6-point harness**

**CHILD RESTRAINT RETAINER CLIP**

**Screen Name:** Retainer Clip

**SAS Data Set:** *CHILDSEAT*

**SAS Variable:** *CLIPDES*

**Oracle Name:** *CHILDSEAT.RETAINERCLIPID*

**Element Attributes:**

Oracle	SAS	
0	0	No clip available, or not designed with retainer clip
1	1	Clip available
-9999	9	Unknown

**Source:** Vehicle inspection, child restraint system inspection, interview

**Remarks:**

This variable explains how the CRS was designed to be used. It does not specify how the CRS was actually used in the crash, or whether it was used as designed.

A chest retainer clip is a plastic device which attaches the two harness straps. The retainer clip should be threaded correctly and positioned at the child’s armpit level. It is designed to keep the shoulder harnesses over the child’s shoulders during a crash. The images below illustrate the chest retainer clip.



**Retainer clip with 5-point harness**



**Retainer clip with T-shield**

**CHILD RESTRAINT TETHER DESIGN**

**Screen Name:** Tether

**SAS Data Set:** *CHILDSEAT*

**SAS Variable:** *TETHDES*

**Oracle Name:** *CHILDSEAT.PICKTETHERDESIGN*

**Element Attributes:**

Oracle	SAS	
0	0	No tether available or not designed with tether
1	1	Tether available
-9999	9	Unknown

**Source:** Vehicle inspection, child restraint system inspection, interview

**Remarks:**

This variable explains how the CRS was designed to be used. It does not specify how the CRS was actually used in the crash, or whether it was used as designed.

The Lower Anchors and Tethers for Children (LATCH) system is comprised of a top tether strap and lower anchor straps. This variable is coded if the CRS was equipped with a top tether strap that is used to secure the top of the CRS to the vehicle.



**LATCH system top tether attached**

**CHILD RESTRAINT LATCH ANCHOR HOOK DESIGN**

**Screen Name:** LATCH  
**SAS Data Set:** CHILDSEAT  
**SAS Variable:** LATCHDES  
**Oracle Name:** CHILDSEAT.LATCHDESIGNID

**Element Attributes:**

Oracle	SAS	
0	0	No LATCH available or not designed with LATCH
1	1	LATCH available
-9999	9	Unknown

**Source:** Vehicle inspection, child restraint system inspection, interview

**Remarks:**

This variable explains how the CRS was designed to be used. It does not specify how the CRS was actually used in the crash, or whether it was used as designed.

All child restraints manufactured after September 1, 2002 will have two lower anchor attachments designed to connect to anchorage points inside the vehicle. The lower anchorage points are mounted within the second and third row seat bights and will secure the CRS to the seat independent of the vehicle's safety belts. The child restraints will also have belt paths for use of the safety belt, and the CRS can be secured using either system.



**LATCH Lower anchor attachments**



**Lower seat anchorage points within vehicle**

**Diagram of LATCH system**

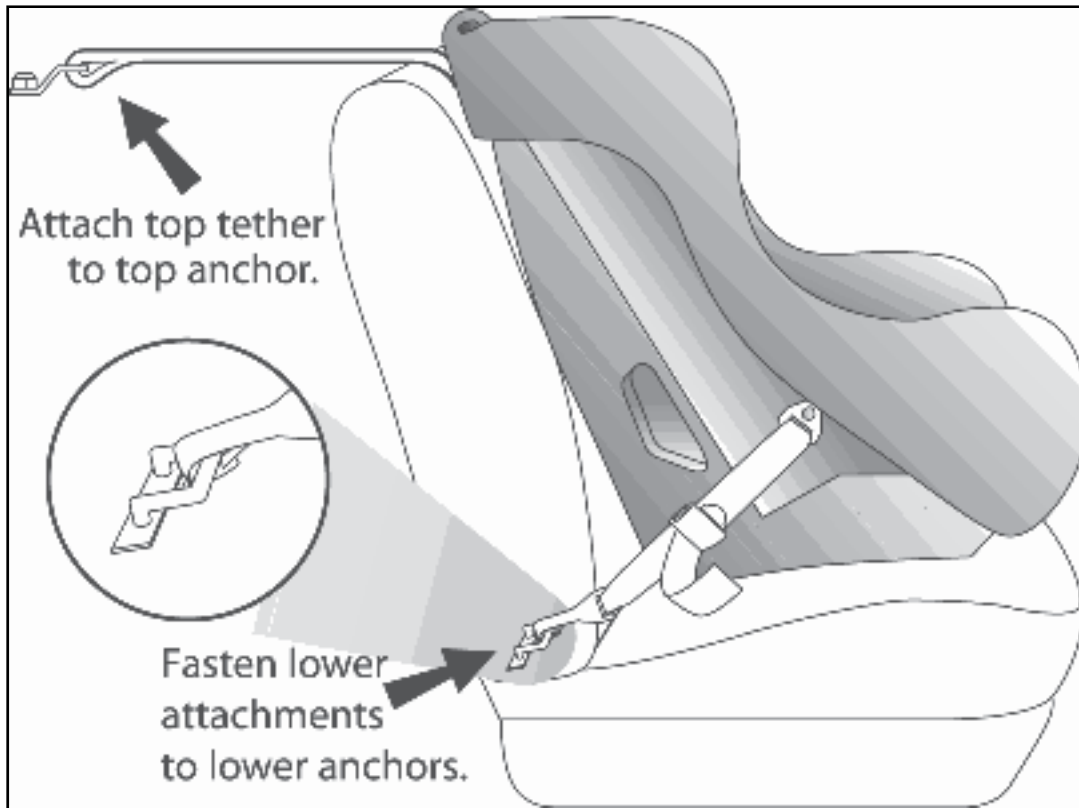



**CHILD RESTRAINT USAGE ORIENTATION**

**Screen Name:** Orientation

**SAS Data Set:** *CHILDSEAT*

**SAS Variable:** *ORIENT*

**Oracle Name:** *CHILDSEAT.PICKORIENTATION*

**Element Attributes:**

Oracle	SAS	
1	1	Rear facing
2	2	Forward facing
3	3	Supine
-9998	8	Other (specify)
-9999	9	Unknown

**Source:** Vehicle inspection, child restraint system inspection, interview

**Remarks:****Rear Facing**

The CRS was facing the rear of the vehicle at the time of the crash.

**Forward Facing**

The CRS was facing the front of the vehicle at the time of the crash.

**Supine**

The CRS was laying flat at the time of the crash.

**Other (specify)**

At the time of the crash the CRS was facing in another direction (i.e., sideways, on top, or underneath something).

**Unknown**

A CRS was present, but the orientation at the time of the crash cannot be determined.

## CHILD RESTRAINT HARNESS/SHIELD USE

Page 1 of 2

Screen Name: Harness/Shield

SAS Data Set: *CHILDSEAT*SAS Variable: *HARUSE*Oracle Name: *CHILDSEAT.PICKHARNESSUSAGE***Element Attributes:**

Oracle	SAS	
1	0	Not designed with harness
2	1	Harness/shield not used
3	2	Harness straps in Top/Highest slots
4	3	Harness straps in the Middle slots
	4	Harness straps in the Bottom/Lower slots
5	5	Harness used, but slots used is unknown
6	6	Retrofitted with Harness
7	7	Shield used
8	9	Other (specify)
-9999	10	Unknown if harness/shield used

Source: Vehicle inspection, child restraint system inspection, interview

**Remarks:**

Make a determination of the harness/shield usage at the time of the crash.

**Not designed with harness**

is used if the CRS did not have an internal harness.

**Harness/shield not used**

is used if the CRS had a harness/shield, but it was not used.

**Harness straps in the Top/Highest slots**

is used if the harness straps were in the highest slots.

**Harness straps in the middle slots**

is used if the harness straps were in any one of the middle slots. **Note:** Some child restraints are equipped with five sets of slots. In these cases, use this code if the harness straps were routed through any of the middle slots.

**Harness straps in the Bottom/Lower slots**

is used if the harness straps were in the lowest slots.

**Harness used – but slots used is unknown**

is used the researcher was unable to determine what slots the harness straps were routed through.

**Retrofitted with Harness**

is used if the original harness straps were replaced prior to the crash.

**Shield used**

is used if the CRS was equipped with a Tray or T-shield in lieu of an internal harness strap system.

**Other (specify)**

is used if the harness straps were routed unconventionally or through different slots. For example, if the right strap was routed through the top slot and the left strap was routed through a middle slot, this attribute would be selected. Whenever the harness strap usage is questionable, use this attribute and specify further.

**Unknown if harness/shield used**

is used when the harness system that used during the crash could not be determined.

**CHILD RESTRAINT RETAINER CLIP USE**

**Screen Name:** Retainer Clip

**SAS Data Set:** *CHILDSEAT*

**SAS Variable:** *CLIPUSE*

**Oracle Name:** *CHILDSEAT.RETAINERCLIPUSEID*

**Element Attributes:**

Oracle	SAS	
1	0	Not designed with retainer clip
2	1	Retainer clip not used
3	2	Retainer clip used – neck level
4	3	Retainer clip used – chest/armpit Level
5	4	Retainer clip used – stomach level
7	5	Retainer clip used – unknown level
6	6	Retrofitted with retainer clip
-9999	9	Unknown if retainer clip used

**Source:** Vehicle inspection, child restraint system inspection, interview

**Remarks:**

The actual CRS harness retainer clip use at the time of the crash must be determined and coded. The position of the retainer clip on the child is usually determined during the interview with the care giver.

**CHILD RESTRAINT TETHER USE****Screen Name:** Tether**SAS Data Set:** *CHILDSEAT***SAS Variable:** *TETHUSE***Oracle Name:** *CHILDSEAT.PICKTETHERUSAGE***Element Attributes:**

Oracle	SAS	
1	0	Not designed with tether
2	1	Tether not used
3	2	Tether used (original tether)
-9999	9	Unknown if tether used

**Source:** Vehicle inspection, child restraint system inspection, interview**Remarks:**

If coded as used, the LATCH tether was anchored to the top tether hook in the vehicle.

**CHILD SEAT LATCH ANCHOR HOOK USE****Screen Name:** LATCH**SAS Data Set:** *CHILDSEAT***SAS Variable:** *LATCHUSE***Oracle Name:** *CHILDSEAT.LATCHUSEID***Element Attributes:**

Oracle	SAS	
1	0	Not designed with LATCH anchor hooks
4	3	LATCH anchor hooks – not used
2	1	LATCH anchor hooks used
-9999	9	Unknown if LATCH anchors were used

**Source:** Vehicle inspection, child restraint system inspection, interview**Remarks:**

If coded as used, LATCH anchor hooks were affixed to the lower anchors in the vehicle.

**BELT ROUTING/USE**

Page 1 of 2

**Screen Name:** Belt Routing/Use**SAS Data Set:** *CHILDSEAT***SAS Variable:** *BELTROUT***Oracle Name:** *CHILDSEAT.BELTROUTING***Element Attributes:**

Oracle	SAS	
5	0	No belt routing
-9998	1	No belt used
1	2	Belt routed through belt positioning slots/channels
2	3	Belt routed through forward facing slots/channels
3	4	Belt routed through rear facing slots/channels
4	5	Belt routed unconventionally (specify)
-9999	9	Unknown belt path

**Source:** Vehicle inspection, child restraint system inspection, interview**Remarks:****No belt routing**

The belt was not routed through any slots/channels in the CRS. The belt was used to solely restrain the child was sitting in the CRS. This attribute is pre-coded for Integrated child restraints.

**No belt used**

No seat belt was used to either restrain the child or install the CRS.

**Belt routed through belt positioning slots/channels**

The belt was routed through the belt positioning slots built into the CRS.

**Belt routed through forward facing slots/channels**

The belt was routed through the forward facing slots or channels built into the CRS.

**Belt routed through rear facing slots/channels**

The belt was routed through the rear facing slots or channels built into the CRS.

**Belt routed unconventionally (specify)**

Any type of unconventionally belt routing.

Belt Routing/Use (cont'd)

Page 2 of 2

**Unknown belt path**

It is not known what path the belt took around the CRS. If it is not known if the belt was used indicate that on the safety belt section and choose this attribute for belt routing.



**USE OF LOCKING CLIP ON VEHICLE BELT**

**Screen Name:** Locking Clip Use

**SAS Data Set:** *CHILDSEAT*

**SAS Variable:** *LOCKCLIP*

**Oracle Name:** *CHILDSEAT.LOCKINGCLIPID*

**Element Attributes:**

Oracle	SAS	
1	0	None present
2	1	Locking clip used on lap and shoulder belt
3	2	Locking clip used on lap belt only
4	3	Locking clip used on shoulder belt only
5	8	Other (Specify)
9	9	Unknown

**Source:** Vehicle inspection, child restraint system inspection, interview

**Remarks:**

When a locking clip is found in a vehicle, photograph should be taken. This variable is not assessing the proper use of the locking clip, it is merely identifying where is it positioned on the belt.

A **locking clip** is usually included with the CRS at the time of purchase and typically found on the back aspect of CRS seat back. The purpose of a **locking clip** is to lock belt systems of vehicles that contain sliding latch plates and emergency locking retractors only (e.g., vehicles that do not have automatic locking capability). Locking clips used on the lap and shoulder belt combination are to be positioned not more than one inch above the latch plate. Seat belts are usually labeled indicating the need of a locking clip and this need is also discussed in the vehicle owner's manual.

**None Present**

When there is no locking clip used in this crash.

**Locking Clip Used on Lap and Shoulder Belt**

When the lap and shoulder belts are threaded through the locking clip during the crash.

**Locking Clip Used on Lap Belt Only**

When the lap belt is threaded through the locking clip during the crash.

**Locking Clip Used on Shoulder Belt Only**

When the shoulder belt is threaded through the locking clip during the crash.

**Other (Specify)**

is used when it is determines a locking clip was used but not in a manner as stated above, Specify how the locking clip was used.

**Unknown**

is used when the usage cannot be determined.



**Locking clip affixed to belt webbing no more than 1 inch above latch plate**



**Locking clip correctly positioned on belt webbing near sliding latch plate**

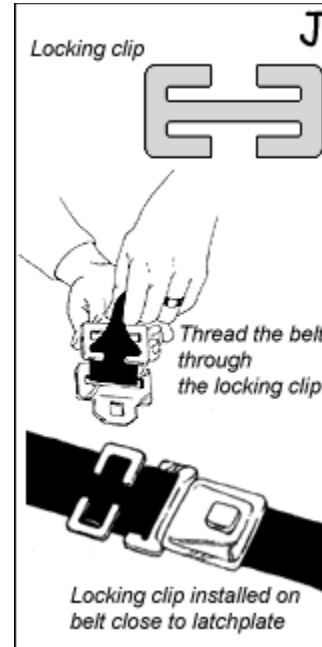

**General instructions on how to position locking clip**



**Locking clip correctly positioned on belt webbing near sliding latch plate**

**Screen Name:** Seat Location

**SAS Data Set:** *CHILDSEAT*

**SAS Variable:** *SEATPOS*

**Oracle Name:** *SEATLOC.SEATROW and SEATLOCATION*

**Element Attributes:**

Seat Number

**Front Row**

11 Left side  
12 Middle  
13 Right side

**Third Row**

31 Left side  
32 Middle  
33 Right side  
34 Other (specify)

**Fifth Row**

51 Left side  
52 Middle  
53 Right side  
54 Other (specify)

**Other Seating**

Cargo Area  
Unknown

**Second Row**

21 Left side  
22 Middle  
23 Right side  
24 Other (specify)

**Fourth Row**

41 Left side  
42 Middle  
43 Right side  
44 Other (specify)

**Source:** Vehicle Inspection/interview

**Remarks:**

See the variable Occupant's Seat Position for more detail on this variable.

All child restraints found inside the vehicles are to be coded into EDS. This includes unoccupied child restraints. This variable assigns a seating location for each CRS. For example, if a vehicle has child restraints present in the second row center and the third row right positions, 22 and 33 should be selected.

There are cases where a child is sitting within a CRS but is not restrained with the lap and shoulder belts or the internal harness. The CRS will still be coded as used and the variables within the CRS section will be coded to reflect the child's unbelted status.

The majority of child restraints are taken from the vehicle either during the removal of the child from the vehicle post-crash or by an occupant/family member after the crash. These restraints can usually be inspected at the home of the interviewee or at the attending hospitals. However, on some occasions the child restraints are discarded prior to the case assignment. In those cases, some details about the CRS can be ascertained during the interview, by on-scene photographs, and by the interior vehicle inspection.

In all cases involving a CRS, it is imperative that the interview is obtained. To properly understand how the CRS was used and how it performed during the crash, the height, weight, and other supportive information about the child is needed. Moreover, to truly understand the experience of the person who was installed the CRS, a direct interview with that individual is vital.

**CHILD RESTRAINT PLACEMENT**

**Screen Name:** Placement

**SAS Data Set:** *CHILDSEAT*

**SAS Variable:** *PLCMNT*

**Oracle Name:** *CHILDSEAT.PLACEMENTID*

**Element Attributes:**

Oracle	SAS	
1	1	Seat
2	2	Floor
3	3	Lap of other occupant
4	4	Console
-9998	8	Other (specify)
-9999	9	Unknown

**Source:** Vehicle inspection, child restraint system inspection, interview

**Remarks:**

**Seat**

CRS placed on vehicle seat.

**Floor**

Child restraint sitting on vehicle floor.

**Lap of Other Occupant**

CRS sitting on lap of another occupant.

**Console**

CRS placed on a console.

**Other (specify**

Other position of CRS (specify).

**Unknown**

Position of CRS could not be determined.

**CHILD POSITION IN CHILD RESTRAINT**

Page 1 of 2

**Screen Name:** Child Position**SAS Data Set:** *CHILDSEAT***SAS Variable:** *POSTN***Oracle Name:** *CHILDSEAT.POSTUREINUSEID***Element Attributes:**

Oracle	SAS	
-9997	0	[Not occupied]
1	1	Upright
2	2	Reclined/lying back
3	3	Supine, facing upwards
4	4	Slumped forward
5	5	Slumped to the Side
6	6	Kneeling
-9998	8	Other (specify)
-9999	9	Unknown

**Source:** Interview**Remarks:****Upright**

Child was sitting upright, facing forward.

**Reclined/Lying Back**

Child was reclined, between 90 and 45 degrees.

**Supine**

Child was laying flat, facing upward.

**Slumped Forward**

Child was leaning.

**Slumped to the Side**

Child was leaning to the side from the waist up and their back was not against the back of the CRS or the vehicle, in the case of a backless booster seat.

**Kneeling**

Child was kneeling while in the CRS.

Child Position In Child Restraint (cont'd)

Page 2 of 2

**Other (specify)**

Any other position of child that can be determined.

**Unknown**

Unknown position of child in the CRS.

**VEHICLE**

Occupant Form, Case #2007-996-900015/Vehicle # 2/Occupant #1

OCCUPANT | EJECTION | ENTRAPMENT | SEAT | AIR BAG | CHILD SEAT | SEAT BELT | INJURY | INJURY CODES | LOG | REVIEW

LIST | DETAIL



CHILD SEAT | **VEHICLE**

Belt Retractor Type

Latch Plate Type

Latch Anchor

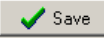
Latch Tether

 Save  Close



**BELT RETRACTOR TYPE**

Page 1 of 2

**Screen Name:** Belt Retractor**SAS Data Set:** SEATLOC**SAS Variable:** ACTBLRET**Oracle Name:** DUPMANUALSEATBELT.RETRACTORTYPEID**Element Attributes:**

Oracle	SAS	
3	0	None Present
2	1	Emergency Locking Retractor
7	2	Automatic Locking Retractor
4	3	Switchable Retractor in ELR Mode
5	4	Switchable Retractor in ALR Mode
6	5	Switchable Retractor in Unknown Mode
9	9	Unknown Type of Retractor

**Source:** Vehicle Inspection, interview**Remarks:**

This variable is coded for all manual seat belts that are coded for any vehicle position.

If a sewn on latch plate is present, there will most likely be a retractor for both the shoulder portion and the lap portion of the belt. Most likely the shoulder portion will be an ELR and the lap portion will be switchable from ELR to ALR. In this variable we are only interested in the retractor of the lap portion of the belt.

Another type of switchable retractor switches when the belt is pulled all the way out causing the retractor to switch to ALR mode.

Retractors wind up the loose webbing of the unused 3-point safety belt, take up the slack, and provides slight tension on belts that are in use. They are usually located out of sight at an anchor point. Check the vehicle owner's manual and also look for labels on the belt webbing to determine the retractor type.

**NOTE** that some newer vehicles have a switchable retractor that can be manually adjusted from ELR to ALR. Most of them can be switched by pulling the webbing all the way out of the retractor to activate the ALR. In some models, the retractors switch from ELR to ALR with the push of a button. Most switchable retractors have a label on the belt with instructions on how to switch it. Enter the information for the position of the retractor.

**Automatic locking retractor (ALR)**

The ALR locks in place after being pulled out and allowed to retract about ½" The belt cannot be extended unless it is first fully rewound. It is generally uncomfortable for adults to wear.

**Emergency locking retractor (ELR)**

The ELR allows the belt to be freely extended or rewound. It locks only when the vehicle slows, changes direction, or stops suddenly. Since the retractor rarely locks during normal driving, it provides more freedom and comfort to an adult driver than an ALR. Some ELRs are vehicle sensitive and lock in direct response to the deceleration of the vehicle. Other ELRs are webbing or belt-sensitive and temporarily lock in response to a quick jerk or pull on the belt. Some ELRs are both vehicle and belt sensitive. Some ELRs have a window shade tension reliever system designed to make 3-point belts more comfortable by allowing "slack" in the shoulder belt. Occupants using these belts "tug" on the shoulder belt to tighten it after they lean forward.

**Unknown**

is used when the type of retractor cannot be determined.

**LATCH PLATE TYPE**

Page 1 of 2

**Screen Name:** Latch Plate**SAS Data Set:** SEATLOC**SAS Variable:** ACTLPLAT**Oracle Name:** DUPMANUALSEATBELT.LATCHPLATETYPEID**Element Attributes:**

Oracle	SAS	
8	0	Not used/not available
1	1	Sliding
2	2	Light weight locking/cinching
3	3	Locking
4	4	Switchable
5	5	Sewn On
6	9	Unknown Type

**Source:** Vehicle Inspection**Remarks:**

This variable is coded for all manual seat belts that are coded for any vehicle position.

**Sliding**

The webbing is threaded through a slot in the latch plate and there is no locking bar. The latch plate slides freely along the webbing, regardless of the angle. Allows the webbing to slip through unrestricted.

**Locking**

The webbing threads through a locking bar or an adjuster in the latch plate. Once it is tightened, the belt will not loosen until the plate is tilted and the belt is unbuckled.

**Lightweight locking/cinching**

The same as locking but with more moving parts. As long as the plate is parallel with the webbing the latch plate is locked.

**Switchable**

Switchable has a switch that locks the belt webbing by sliding a button.

**Sewn on**

If a sewn on latch plate is present, there will be a retractor for both the shoulder portion and the lap portion of the belt. Most likely the shoulder portion will be an ELR and the lap portion will be switchable.

**Unknown type**

is used when the type of latch plate is not determined.

Sliding



Sliding



Lightweightlocking/cinching

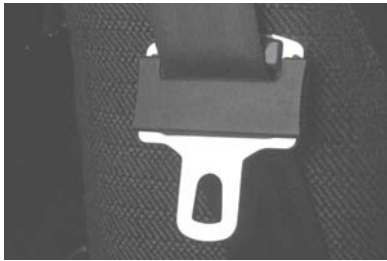

Lightweight locking/cinching



Locking



Locking



Switchable



Switchable  
Sewn on

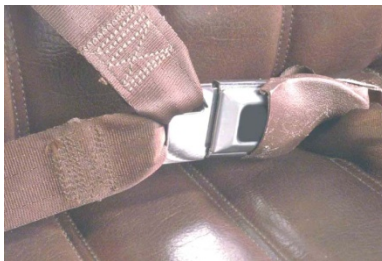

Sewn on

**LATCH LOWER ANCHOR AVAILABILITY**

**Screen Name:** LATCH Anchor

**SAS Data Set:** SEATLOC

**SAS Variable:** LATANCH

**Oracle Name:** SEATLOC.LATCHANCHORID

**Element Attributes:**

Oracle	SAS	
1	0	No
2	1	Yes
9	9	Unknown if anchor

**Source:** Interior Vehicle Inspection (and/or Interview)

**Remarks:**

Currently, some new passenger vehicles are equipped with lower child seat anchorage points between a vehicle's seat cushion and seat back. Together, the two lower anchorage points and top tether anchorage make the Lower Anchor and Tether for Children (LATCH) system. Since 2002, this system is required in two rear seating positions of all cars, minivans, and light trucks.

A lower anchorage is a small rod or bar located between a vehicle's seat cushion and seat back allowing a child safety seat to be attached or snapped into the vehicle instead of being held secure by the vehicle's belt system. By September 1, 2002, all child safety seats will have two attachments which will connect to the vehicle's lower anchorage attachment points. (Some child seat manufacturers have included lower anchorage points in year 2000 models.)

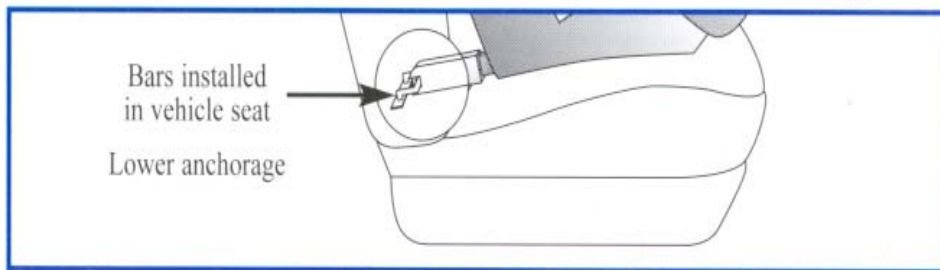

**LATCH TETHER AVAILABILITY**

**Screen Name:** LATCH Tether

**SAS Data Set:** SEATLOC

**SAS Variable:** LATTETH

**Oracle Name:** SEATLOC.LATCHTETHERID

**Element Attributes:**

Oracle	SAS	
1	0	No
2	1	Yes
9	9	Unknown if tether

**Source:** Interior Vehicle Inspection (and/or Interview)

**Remarks:**

In some vehicles, such as mini-vans and station wagons, the tether anchor may be found on the rear floor of the vehicle, on the back of the rear seat, and on the roof area. It may be concealed by some sort of covering which can be removed or “flipped up”.

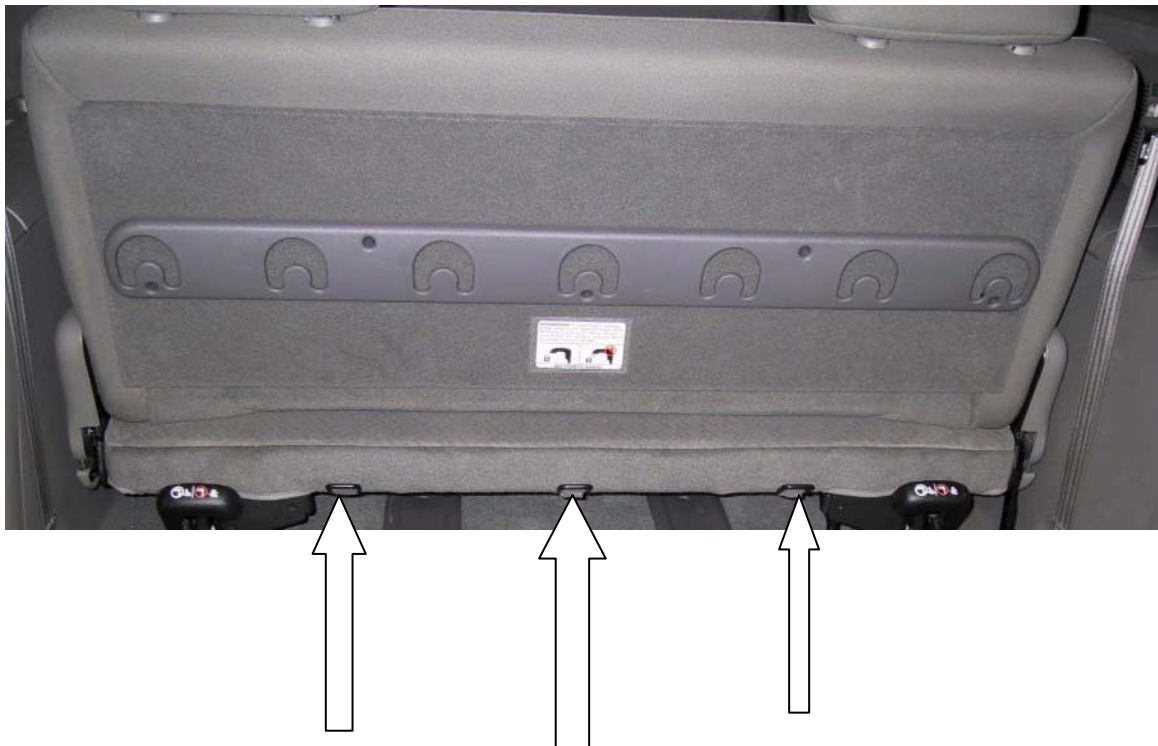

MANUAL SEAT BELT

Occupant Form, Case #2010-8701-030A/Vehicle # 1/Occupant #1

OCCUPANT | EJECTION | ENTRAPMENT | SEAT | AIR BAG | CHILD SEAT | SEAT BELT | LOG | INJURY | INJURY CODES | REVIEW

MANUAL

BELT | COMPONENTS

Availability   **Vehicle Inspection**

Used in this crash?

Position

Lap

Shoulder

Malfunction

Anchorage Adjustment

Source of Belt Use

**MANUAL (ACTIVE) BELT SYSTEM AVAILABILITY**

Page 1 of 3

**Screen Name:** Availability**SAS Data Set:** OA**SAS Variable:** MANAVAIL**Oracle Name:** MANUALEATBELT.PICKMANUALBELTAVAIL**Element Attributes:**

Oracle	SAS	
1	0	None available
2	1	Belt removed/destroyed
3	2	Shoulder belt
4	3	Lap belt
5	4	Lap and shoulder belt
6	5	Belt available - type unknown
7	6	Shoulder belt (lap belt destroyed/removed)
8	7	Lap belt (shoulder belt destroyed/removed)
9	8	Other belt (specify)
10	9	Unknown

**Source:** Researcher determined—primary source is vehicle inspection, secondary sources include medical records, and the interview.

**Remarks:**

The **Vehicle Inspection** portion of this screen shows what was determined **at the vehicle inspection** which is the primary source of information for these variables. **However**, the researcher should use all the available information, placing emphasis on the vehicle inspection information, to make the final determination for completion of this variable.

Some belt restraint systems are a combination of manual (active) and automatic (passive) occupant protection devices. For this variable, consider only the manual portion of the system. Select the manual belt system which was available at the time of the crash for this occupant.

Select the manual belt system which was available for use by the occupant relative to the seat position in the vehicle.

**Not available**

indicates: (1) that at the time of the crash the designated seating position was not equipped with a manufacturer installed or post manufacturer installed manual belt (lap, shoulder, or lap and shoulder) or (2) the seat position was equipped only with an automatic (passive) belt system.



**Belt removed/destroyed**

indicates that the manual belt, initially installed at this occupant's seating position, was subsequently removed or destroyed (*e.g.*, unbolted, cutout, etc.). If the belt is present but nonfunctional, then select the type of manual belt available on this variable and use **Inoperative** for **Used In This Crash?**

Belts which are knotted, buckled at the rear of the seat (bench or bucket), stored below the seat, etc., are available if they were otherwise operative.

**Shoulder belt**

is used when this occupant's seat position was equipped with a manual upper torso restraint and no lap belt. The population of vehicles equipped with only manual shoulder belts is very small, therefore, care must be taken that a two-point passive belt is not identified as a manual belt.

**Lap belt**

is used when this occupant's seat position is equipped with a manual belt that secures the pelvic area of the occupant in the seat and there is no manual upper torso belt.

**Lap and shoulder belt**

is used when both a manual upper torso belt and a manual lap (pelvic area) belt are present at this occupant's seat position.

**Belt available — type unknown**

is used when there is no vehicle inspection and there is disagreement regarding the type of manual belt system among the secondary sources. When the specific manual belt system cannot be determined, but it is known some type of belt is present, then use this attribute.

**Shoulder belt (lap belt destroyed/removed)**

is used for integral noncontinuous loop manual belt systems when the lap belt portion of the belt has been removed or destroyed leaving only the shoulder belt portion present at this occupant's seating position.

**Lap belt (shoulder belt destroyed/removed)**

is used for an integral noncontinuous loop manual belt systems when the shoulder belt portion of the belt has been removed or destroyed leaving only the lap belt portion present at this occupant's seating position.

**Other belt (specify)**

is used when the belt system is nonstandard or cannot be described with other attributes. Specify (write out in the Specify Box) the type of manual belt (*e.g.*, 5 point competition harness, 4 inch wide webbing, etc.) In addition, use this attribute if a properly positioned "built-in" child safety seat was available at this occupant's seating position. Other child restraints are not recorded here.

**Unknown**

is used when it cannot be determined whether or not manual belts were available for this occupant's seat position.

**OCCUPANT FORM**  
**MANUAL (ACTIVE) BELT SYSTEM USED IN THIS CRASH?**

**SEAT BELT/MANUAL/BELT**

**Screen Name:** Used in this crash?

**SAS Data Set:** *OA*

**SAS Variable:** *MANUSE*

**Oracle Name:** *MANUALBELTUSE.MANUALBELTTYPEUSED*

**Element Attributes:**

Oracle	SAS	
0	0	None used not available/removed or destroyed
1	1	Inoperative (specify)
2	2	Shoulder belt
3	3	Lap belt
4	4	Lap and shoulder belt
5	5	Belt used — type unknown
6	8	Other belt used (specify)
7	12	Shoulder belt with child safety seat
8	13	Lap belt with child safety seat
9	14	Lap and shoulder belt with child safety seat
10	15	Belt with child safety seat — type unknown
11	18	Other belt with child safety seat (specify)
12	99	Unknown if belt used

**Source:** Researcher determined—primary source is vehicle inspection, secondary sources include medical records, and the interview.

**Remarks:**

The **Vehicle Inspection** portion of this screen shows what was determined **at the vehicle inspection** which is the primary source of information for these variables. **However**, the researcher should use all the available information, placing emphasis on the vehicle inspection information, to make the final determination for completion of this variable.

Select the manual belt system or portion of the system which was in use at the time of the crash by the occupant. The correctness of the use is not assessed on this variable. This variable only identifies manual belt usage; do not consider the presence and use of a passive belt system.

**None used/not available/removed or destroyed**  
is used when a manual belt was available but not worn.

**Inoperative (specify)**  
includes belts which are knotted, jammed, tucked behind the seat, or in any other fashion rendered unusable. In addition, use this attribute for belts which are inoperative because of extreme

deterioration from aging. A belt system that was completely removed from or cut out of a vehicle is assigned None used/not available /removed or destroyed.

**Shoulder belt**

is used when a manual shoulder belt alone was in use. This can occur when: (1) the vehicle was not equipped with a lap belt, (2) only the shoulder belt portion of a nonintegral system was in use, or (3) when the lap belt portion of a noncontinuous loop integral lap and shoulder belt system was cut out leaving only a functional shoulder belt portion in use.

**Lap belt**

is used when a manual lap belt alone was in use. This can occur when: (1) the vehicle was not equipped with a shoulder belt, (2) only the lap belt portion of a nonintegral system was in use, or (3) when the shoulder belt portion of a noncontinuous loop integral lap and shoulder belt system was cut out leaving only a functional lap belt portion in use. **Note**, manual lap belts can be used in conjunction with a two-point automatic belt system. For manual and automatic belt combinations, use this attribute for the manual lap belt usage.

**Lap and shoulder belt**

is used when the occupant is: (1) "encompassed" **both** in the lap and upper torso region by a manual lap and shoulder belt combination, or (2) using only a portion of an **intact integral** lap and shoulder belt system. For example, if a person has an integral lap and shoulder belt but is only using the lap portion (*i.e.*, having the shoulder belt behind his or her back), then use this attribute.

**Belt used — type unknown**

is used when it is known that the type of manual belt system being used cannot be determined.

**Other belt (specify)**

is used when the belt system is nonstandard or cannot be described with other attributes. Specify the type of manual belt (*e.g.*, 5 point competition harness, 4 inch wide webbing, etc).

**Shoulder with child safety seat**

is used when the vehicle's manual shoulder belt system anchors a child safety seat to the vehicle, or when the shoulder belt is used to restrain a child who is sitting on a booster seat. These attributes do not refer to the belts which are part of the child seat itself.

**Lap with child safety seat**

is used when the vehicle's manual lap belt system anchors a child safety seat to the vehicle, or when the lap belt is used to restrain a child who is sitting on a booster seat. These attributes do not refer to the belts which are part of the child seat itself.

**Lap and shoulder w/child safety seat**

is used when the vehicle's manual lap and shoulder belt system anchors a child safety seat to the vehicle, or when the lap/shoulder belt is used to restrain a child who is sitting on a booster seat. These attributes do not refer to the belts which are part of the child seat itself.

**Belt with child safety seat — type unknown**

is used when the vehicle belt type is unknown, not the child safety seat type.

**Other belt with child safety seat (specify)**

is used when a built-in child safety seat is “self contained” (does not use any part of the regular existing manual belt system available at the occupant seating position).

**Unknown if belt used**

is used if it cannot be determined whether or not a manual belt was in use by the occupant at the time of the crash.

## POSITION OF MANUAL BELT/LAP PORTION OF BELT

Page 1 of 2

Screen Name: Lap

*SAS Data Set:**SAS Variable:**Oracle Name: MANUALBELTUSE.LAPPOSITIONID***Element Attributes:**

Oracle	SAS	
0	0	[Not equipped/not available/not used]
1	1	Snug and low across hips
2	2	Across abdomen
3	3	Used to install child restraint
4	4	Low across hips with extra "slack room"
5	5	Across abdomen with extra "slack room"
98	98	Other position (specify)
99	99	Unknown position

**Source:** Interview and injuries and medical records**Remarks:**

If the manual lap belt is being used to install a child restraint than chose "Other position (specify)" and annotate. The routing of the manual lap belt/lap portion (if any) through the child restraint is indicated in the variable "Seat Belt Routing" on the Child Restraint Tab.

If two occupants are using one belt code as "Other (specify)" to both occupants and annotate.

**Snug and low across hips**

the manual lap belt or lap portion of a 3 pt manual belt is snug and low across the hips so that it goes around the front of pelvis, with the webbing lying across the top of thighs.

**Across abdomen**

the manual lap belt or lap portion of a 3 pt manual belt snug and is across the "belly" or abdomen.

**Low across hips with extra "slack room"**

the manual lap belt or lap portion of a 3 pt manual belt is low across the hips so that it goes around the front of pelvis, with the webbing lying across the top of thighs and is not tight against the person, but has extra "slack room".

Position of manual belt/Lap portion of belt (cont'd)

Page 2 of 2

**Across abdomen with extra “slack room”**

the manual lap belt or lap portion of a 3 pt manual belt is across the “belly” or abdomen and is not tight against the person, but has extra “slack room”.

**Other position (specify)**

is used to document the use of the lap portion in a manner not identified in the above.

**Unknown position**

is used if it cannot be determined the position of the manual belt/lap portion by the occupant at the time of the crash.

**POSITION OF MANUAL SHOULDER BELT/SHOULDER PORTION OF BELT**

**Screen Name:** Shoulder

**SAS Data Set:**

**SAS Variable:**

**Oracle Name:** *MANUALBELTUSE.SHLDPOSITIONID*

**Element Attributes:**

Oracle	SAS	
0	0	[Not equipped/not available/not used]
1	1	Snugly across the collarbone and over shoulder
2	2	Resting on neck
3	3	On edge of shoulder
4	4	Under arm
5	5	Behind occupant’s back or seat
10	10	Used to install child restraint
6	6	Across the collarbone and over shoulder with extra “slack room”
7	7	Resting on neck with extra “slack room”
8	8	On edge of shoulder with extra “slack room”
9	9	Under arm with extra “slack room”
98	98	Other position (specify)
99	99	Unknown belt position

**Source:** Interview and medical records

**Remarks:**

If the manual shoulder belt is being used to install a child restraint then chose "Other position (specify)" and annotate. The routing of the manual lap belt/shoulder portion (if any) through the child restraint is indicated in the variable “Seat Belt Routing” on the Child Restraint Tab.

If two occupants are using one belt code as "Other (specify)" to both occupants and annotate.

**Snugly across the collarbone and over shoulder**

the manual shoulder belt or shoulder portion of a 3 pt manual belt fits snugly and is routed over the collarbone and over the shoulder.

**Resting on neck**

the manual shoulder belt or shoulder portion of a 3 pt manual belt is routed such that it is rubbing against the neck.



**On edge of shoulder**

the manual shoulder belt or shoulder portion of a 3 pt manual belt is worn on the edge of the shoulder.

**Under arm**

the manual shoulder belt or shoulder portion of a 3 pt manual belt is placed under the arm.

**Behind occupant's back or seat**

the manual shoulder belt or shoulder portion of a 3 pt manual belt is placed behind the back of the occupant or behind the back of the seat.

**Across the collarbone and over shoulder with extra "slack room"**

the manual shoulder belt or shoulder portion of a 3 pt manual belt is routed over the collarbone and over the shoulder and is not tight against the person, but has extra "slack room".

**Resting on neck with extra "slack room"**

the manual shoulder belt or shoulder portion of a 3 pt manual belt is routed such that it is rubbing against the neck and is not tight against the person, but has extra "slack room".

**On edge of shoulder with extra "slack room"**

the manual shoulder belt or shoulder portion of a 3 pt manual belt is worn on the edge of the shoulder and is not tight against the person, but has extra "slack room".

**Under arm with extra "slack room"**

the manual shoulder belt or shoulder portion of a 3 pt manual belt is placed under the arm and is not tight against the person, but has extra "slack room".

**Other position (specify)**

is used to document the use of the shoulder portion in a manner not identified in the above.

**Unknown position**

is used if it cannot be determined the position of the manual belt/shoulder portion by the occupant at the time of the crash.

## MANUAL (ACTIVE) BELT MALFUNCTION MODES DURING CRASH

Page 1 of 2

Screen Name: Malfunction

SAS Data Set: OA

SAS Variable: MANFAIL

Oracle Name: MANUALBELTUSE.MANUALBELTFAILURE

**Element Attributes:**

Oracle	SAS	
0	0	[None used/not available/removed or destroyed]
1	1	No manual belt malfunction(s)
2	2	Torn webbing (stretched webbing not included)
3	3	Broken buckle or latch plate
4	4	Upper anchorage separated
5	5	Other anchorage separated (specify)
6	6	Broken retractor
7	7	Combination of above (specify)
8	8	Other manual belt malfunction (specify)
9	9	Unknown

**Source:** Researcher determined—primary source is vehicle inspection, additional input may include the interview and police report if a vehicle inspection is obtained.

**Remarks:**

The **Vehicle Inspection** portion of this screen shows what was determined **at the vehicle inspection** which is the primary source of information for these variables. **However**, the researcher should use all the available information, placing emphasis on the vehicle inspection information, to make the final determination for completion of this variable.

If any component of the manual belt system malfunctions during the impact as a result of occupant loading, the malfunction is captured in this variable. The malfunction is also recorded on the **Case Form/Summary Tab** and documented with photographs.

If a malfunction occurs, select the attribute which corresponds to the appropriate manual belt malfunction mode that describes the component of the restraint system which malfunctioned (*i.e.*, torn webbing, broken buckle or latchplate, anchorage separation, broken retractor). A complete and documented description of the malfunctioned component and the way it malfunctioned must accompany the case.

**No manual belt malfunction(s)**

is used when there is no physical evidence from the vehicle inspection to indicate that a malfunction occurred.

**Combination of above (specify)**

is used when any combination of specified attributes occur and describes multiple manual belt malfunction modes. Manual belt malfunction modes which are not described are reported in **Other manual belt malfunction (specify)**. Manual belt malfunctions **with specific attributes** take priority over the **Other manual belt malfunction** code.

**Other manual belt malfunction (specify)**

is used when the only manual belt malfunction(s) which occur are not described with a specific attribute.

**Unknown**

is used when it can not be determined if the manual belt malfunctioned.

## MANUAL SHOULDER BELT UPPER ANCHORAGE ADJUSTMENT

Page 1 of 2

**Screen Name:** Anchorage Adjustment

**SAS Data Set:** *OA*

**SAS Variable:** *MANANCH*

**Oracle Name:** *MANUALBELTUSE.PICKUPPERANCHORPOSITION*

**Element Attributes:**

Oracle	SAS	
0	0	[No manual shoulder belt]
1	1	None for manual shoulder belt
2	2	In full up position
3	3	In mid position
4	4	In full down position
5	5	Position unknown
6	9	Unknown if adjuster present

**Source:** Researcher determined—primary source is vehicle inspection, secondary sources include the interview.

**Remarks:**

Complete this variable regardless of manual shoulder belt usage.

The **Vehicle Inspection** portion of this screen shows what was determined **at the vehicle inspection** which is the primary source of information for these variables. **However**, the researcher should use all the available information, placing emphasis on the vehicle inspection information, to make the final determination for completion of this variable.

**None for manual shoulder belt**

is used when a manual shoulder belt is present but there is no adjustment mechanism at the upper anchorage point.

**In full up position**

is used when the manual shoulder belt is equipped with an adjustable upper anchorage point and it was in its highest position at the time of the crash (*e.g.* closest position to the roof).

**In mid position**

is used when the manual shoulder belt is equipped with an adjustable upper anchorage point and it was in a middle position at the time of the crash (somewhere between full up and full down).

**In full down position**

is used when the manual shoulder belt is equipped with an adjustable upper anchorage point and it was in its lowest position at the time of the crash (closest position to the floor).

**Position unknown**

is used when the manual shoulder belt is equipped with an adjustable upper anchorage point but it cannot be determined what the position was at the time of the crash.

**Unknown if adjuster present**

is used when it cannot be determined if the manual shoulder belt was equipped with an adjustable upper anchorage device.

**SOURCE OF RESEARCHER'S DETERMINATION OF BELT USE**

**Screen Name:** Source of Belt Use

**SAS Data Set:** *OA*

**SAS Variable:** *MBELTSOU*

**Oracle Name:** *MANUALBELTUSE.SOURCEBELTUSE*

**Element Attributes:**

Oracle	SAS	
1	0	Not equipped/not available
2	1	Vehicle Inspection
3	2	Official Injury Data
4	3	Driver/occupant interview
5	8	Other (specify)
6	9	Unknown if belt used

**Source:** Researcher determined

**Remarks:**

This variable explains what preponderance of information the researcher used to make the determination whether the manual seat belt was used, **not** whether the belt system was available. **The PAR is not an acceptable source to list for belt use determination.** If multiple sources of information are available, select the source that gives the most reliable information.

**Vehicle Inspection**

is used if the vehicle inspection gave definitive indications that the belt was in use.

**Official Injury Data**

is used if the official injury data makes a specific mention of injury patterns that can be attributed to the use of a seat belt, and the vehicle inspection did not give definitive indications of usage.

**Driver/occupant interview**

is used if the vehicle inspection did not give definitive indications of usage or there was no vehicle inspection, however the interview(s) provided significant information to code belt use.

**Other (specify)**

is used when information from other official sources such as the EMS, fire department (e.g., rescue or extrication personnel), or on-scene photographs indicates that the occupant was or was not restrained by a manual or automatic belt at the time of the crash. Specify the source of the information.

Occupant Form, Case #2007-996-900015/Vehicle # 2/Occupant #1

OCCUPANT | EJECTION | ENTRAPMENT | SEAT | AIR BAG | CHILD SEAT | SEAT BELT | INJURY | INJURY CODES | LOG | REVIEW

MANUAL | AUTOMATIC

BELT | COMPONENTS

**Vehicle Inspection**

Pretensioner

Belt Positioning

Presence

Use

Source of Belt Use

**SEAT BELT POSITIONING DEVICE PRESENCE**

Page 1 of 2

**Screen Name:** Positioning Device Presence**SAS Data Set:** *OA***SAS Variable:** *POSPRES***Oracle Name:** *MANUALBELTUSE.BELTPOSDEVICEID***Element Attributes:**

Oracle	SAS	
1	0	None present
2	1	Buckle Buddy – Shoulder Belt Adjuster
3	2	Sta-n-Place – Shoulder Belt Adjuster
4	3	Belt-A-Way – Shoulder Belt Adjuster
5	4	Shoulder Strap Adjuster – Shoulder Belt Adjuster
6	5	Child Protector – Lap and Shoulder Belt Adjuster
7	6	SafeFit – Shoulder Belt Adjuster
8	7	SafeFit Supreme - Shoulder Belt Adjuster
9	8	Seat Belt Adjuster – Shoulder Belt Adjuster
10	9	Klunk-Klip – Shoulder Belt Adjuster
11	10	Child Safer – Shoulder Belt Adjuster
12	11	Comfort Ride – Shoulder Belt Adjuster
13	12	Belt Buddy
14	97	OEM device
15	98	Other (specify)
-9999	99	Unknown if present

**Source:** Vehicle Inspection and/or interview.**Remarks:**

This variable is coded for any position containing a shoulder belt.

Aftermarket seat belt positioning devices are typically manufactured for use by small stature adults, large adults and children to adjust lap and shoulder belt fit and comfort.

These products are not considered “safety devices” and are not tested or regulated by NHTSA.

**Other (specify)**

includes belt extension devices. Annotate the name and type of device.



Examples of seat belt positioning devices:



GM rear seat shoulder belt comfort guide



Belt buddy



Buckle buddy



Shoulder strap

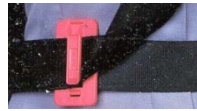

Shoulder strap adjusters

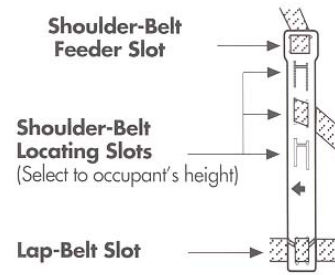

**SEAT BELT POSITIONING DEVICE USE**

**Screen Name:** Position Device Use

**SAS Data Set:** *OA*

**SAS Variable:** *POSUSE*

**Oracle Name:** *MANUALBELTUSE.BELTPOSDEVICEUSEID*

**Element Attributes:**

Oracle	SAS	
3	3	[None present]
1	1	Device not used
2	2	Device used
-9999	9	Unknown if device used

**Source:** Vehicle Inspection and Interview

**Remarks:**

INJURY/PSU

Occupant Form, Case #2007-996-900015/Vehicle # 2/Occupant #1

OCCUPANT | EJECTION | ENTRAPMENT | SEAT | AIR BAG | CHILD SEAT | SEAT BELT | INJURY | INJURY CODES | LOG | REVIEW

INJURY

PAR Severity

Mortality

Treatment

Initial Facility

Hospital Stay  days

Work Days Lost  days

Save Close

**Screen Name:** PAR Severity  
**SAS Data Set:** OA  
**SAS Variable:** INJSEV  
**Oracle Name:** OCCUPANT.PARKABCOU

**Element Attributes:**

Oracle	SAS	
1	0	O — No injury
2	1	C — Possible injury
3	2	B — Nonincapacitating injury
4	3	A — Incapacitating injury
5	4	K — Killed
6	5	U — Injury, severity unknown
7	6	Died prior to crash
8	9	Unknown

**Source:** Police report.

**Remarks:**

**Rolled up from Occupant Tab.**

If the police report contains a detailed description of the injuries but does not translate the injuries into the KABCO codes, use the police method for doing so. For example, injuries which are considered to be of an incapacitating nature are classified as "A", Nonincapacitating-evident injuries are classified as "B", and possible injuries are "C". Property damage only (i.e., no injury) is classified as "O".

Enter **Injured, Severity Unknown** if the police report indicates a "U" or in any other way communicates the idea that the person was injured but the severity is unknown.

Enter **Died Prior to Crash** only if the police explicitly states the person died prior to the crash. This code is also used if the police report indicates the person died as a result of natural causes (e.g., heart attack), disease, drug overdose or alcohol poisoning. This code does not apply if the police report specifically states that the cause of death is a result of crash-related injury or that on-set occurred after the crash. Further clarification: this code applies if the police report indicates that the person died as a result of natural causes (e.g., heart attack), disease, drug overdose or alcohol poisoning, but is silent about the time of on-set and if on-set is the result of injuries sustained in the crash.

As a general rule, if the PAR is "blank" where the injury severity is assessed and the person was at the scene during the police investigation, enter **No Injury (O)**. If the PAR is "blank" and the person was not present during the police investigation, enter **Unknown**.

**U — Injury, severity unknown**

is used when the police report indicates a "U" or in any other way communicates the idea that the person was injured but their severity is unknown.

**Died prior to crash**

is only used if the police explicitly so indicate.

The following states use the KABCO injury coding scheme: Illinois (incl. Chicago), Michigan, New Mexico, North Carolina, Texas (incl. Dallas), Wisconsin, and the city of Los Angeles.

Not all states use the KABCOU scheme. Listed below, by state, are alternative schemes; a mapping to the NASS scheme is provided.

<b>State</b>	<b>PAR Code/Definition</b>		<b>NASS Scheme/Code</b>
<b>Alabama</b>	K	= Killed	K - 4
	A	= Visible or carried from scene	A - 3
	B	= Bruise/abrasion/swelling	B - 2
	C	= Not visible - has pain/faint	C - 1
	Blank	= No documentation of driver or occupant injury	Blank - 0
	99	= Unknown injury	- 9
		-	
<b>Arizona</b>	5	= Fatal Injury	K - 4
	4	= Incapacitating injury	A - 3
	3	= Non-incapacitating Evident	B - 2
	2	= Possible Injury	C - 1
	1	= No injury	O - 0
	6	= Unknown	U - 9

<b>California</b>	1	= Fatal	K - 4
	2	= Severe injury	A - 3
	3	= Other visible injury	B - 2
	4	= Complaint of pain	C - 1
	Blank	= Occupant present	O - 0
	Blank	= Occupant not present	- 9

<b>Colorado</b>	5	= Fatal	K - 4
	4	= Evident - incapacitating	A - 3
	3	= Evident - non-incapacitating	B - 2
	2	= Possible injury	C - 1
	1	= No injury	O - 0

\*There is a box at the top of the PAR indicating number of persons injured. If this box is marked 0 and the injury code is left "blank", assume "No injury". If the box is marked 1 (or more) pertaining to the vehicle occupants in question and the injury code is "blank", assume "Injured, severity unknown". If "blanks" are present in both the persons injured box and the injury code box, assume "Unknown".

<b>Florida</b>	5	= Fatal (within 90 days) injury	K - 4
	4	= Incapacitating	A - 3
	3	= Non-Incapacitating	B - 2
	2	= Possible	C - 1
	1	= None	O - 0
		= No set unknown code	- 9
	6	= Non-traffic fatality	- 9

<b>Illinois</b>	K	= Fatal	K - 4
	A	= Incapacitating Injury	A - 3
	B	= Non-Incapacitating Injury	B - 2
	C	= Reported not evident	C - 1
	O	= No indication of injury	O - 0
		= No set unknown code	- 9

**Indiana**

**Injury Status:**

- i. Code “refused” as no injury when “Nature of Most Severe Injury” is blank.
- ii. If the officer selects a code for “Nature of Most Severe Injury” that does not correspond to the code for “Victim’s Injury Status,”
  - 1. Use the “Victim’s Injury Status” to determine the crash stratum and injury severity.
  - 2. If “Victim’s Injury Status” is blank, default to “Nature of Most Severe Injury.”
  - 3. If “Victim’s Injury Status” indicates a fatal injury, verify that someone was killed on the front of the PAR. Do not use the block on the front of the PAR showing number injured to verify other injuries.
  - 4. If the “Nature of Most Severe Injury” information reflects a more severe injury than that reflected by the “Injury Status” box, upgrade the injury to match iii. Use the table below to determine injury status.
- iii. Use the table below to determine injury status

\*There is a box at the top of the PAR indicating number of persons injured. If this box is marked 0 and the injury code is left "blank", assume "No injury". If the box is marked 1 (or more) pertaining to the vehicle occupants in question and the injury code is "blank", assume "Injured, severity unknown". If "blanks" are present in both the persons injured box and the injury code box, assume "Unknown."

Nature of Most Severe Injury	Victim’s Injury Status	NASS Scheme/Code
Any Entry	Fatal injury	K (see note ii above)
Severed	Incapacitating - Nonfatal Injury	A
Internal	Incapacitating -- Nonfatal Injury	A
Minor Burn	Non-incapacitating B Nonfatal Injury	B
Severe Burn	Incapacitating -- Nonfatal Injury	A
Abrasion	Non-incapacitating B Nonfatal Injury	B
Minor Bleeding	Non-incapacitating B Nonfatal Injury	B
Severe Bleeding (arterial)	Incapacitating -- Nonfatal Injury	A
Fracture/dislocation	Incapacitating -- Nonfatal Injury	A
Contusion/bruise	Non-incapacitating B Nonfatal Injury	B
Complaint of pain	Possible B Nonfatal Injury	C
None Visible	Not Reported B Nonfatal Injury	O
Other (explain in narrative)	Possible B Nonfatal Injury	C
Unknown	Unknown B Nonfatal Injury	U

<b>State</b>	<b>PAR Code/Definition</b>		<b>NASS Scheme/ Code</b>
<b>Iowa</b>			
	1	= Fatal	K - 4
	2	= Incapacitating	A - 3
	3	= Non-incapacitating	B - 2
	4	= Possible	C - 1
	5	= Uninjured	O - 0
	9	= Unknown	U - 9
<b>Kentucky</b>			
	1	= Fatal	K - 4
	2	= Incapacitating	A - 3
	3	= Non-Incapacitating	B - 2
	4	= Possible Injury	C - 1
	5	= None Detected	O - 0
<p>*There is a box at the top of the PAR indicating number of persons injured. If this box is marked 0 and the injury code is left "blank", assume "No injury". If the box is marked 1 (or more) pertaining to the vehicle occupants in question and the injury code is "blank", assume "Injured, severity unknown". If "blanks" are present in both the persons injured box and the injury code box, assume "Unknown".</p>			
<b>Maryland</b>			
	05	= Fatal	K - 4
	04	= Disabled (Incapacitated)	A - 3
	03	= Injured - not Incapacitated	B - 2
	02	= Possible injury	C - 1
	01	= Not Injured (& present)	O - 0
	01	= Not Known (if left scene)	- 9
	Blank	= No documentation of driver or occupants on front of PAR	9



**OCCUPANT FORM****INJURY/PSU**

Police Injury Severity (Police Rating) (cont'd)

Page 6 of 9

<b>State</b>	<b>PAR Code/Definition</b>		<b>NASS Scheme/ Code</b>
<b>Massachusetts</b>			
	1	= Fatal Injury	K - 4
	2	= Incapacitating	A - 3
	3	= Non-incapacitating	B - 2
	4	= Possible	C - 1
	5	= No injury	O - 0
	99	= Unknown	- 9
<b>Missouri</b>			
	1	= Fatal	K - 4
	2	= Disabling	A - 3
	3	= Evident-Not Disabling	B - 2
	4	= Probable-Not Apparent	C - 1
	5	= None Apparent	O - 0
	6	= Unknown	U - 9
<b>Nebraska</b>			
	1	= Killed	K - 4
	2	= Disabling - cannot leave scene without assistance	A - 3
	3	= Visible but not disabling	B - 2
	4	= Possible but not visible	C - 1
	Blank	= Occupant present	O - 0
	Blank	= Occupant not present	- 9
<b>North Carolina</b>			
	K-1	Killed	K - 4
	A-2	A-Type Injury (Disabling)	A - 3
	B-3	B-Type Injury (Evident)	B - 2
	C-4	C-Type Injury (Possible)	C - 1
	O-5	No Injury	O - 0
	-6	Unknown	- 9

**New Jersey**

<b>Victim's Physical Condition [PAR Column 86]</b>	<b>Location of Most Severe Injury [PAR Column 89]</b>	<b>Type of Most Severe Physical Injury [PAR Column 90]</b>	<b>NASS Scheme/Code</b>
01 Killed	01-12 Any Entry	01-08 Any Entry	K-4
02 Incapacitated	01-12 Any Entry	01-08 Any Entry	A-3
03 Moderate Injury or 04 Complaint of Pain	01-12 Any Entry	01 Amputation 02 Concussion 03 Internal 04 Fracture/Dislocation	A-3
03 Moderate Injury or 04 Complaint of Pain	03 Eye	04 Bleeding 06 Burn 08 Complaint of Pain	A-3
03 Moderate Injury	01-12 Any Entry	04 Bleeding 05 Contusion/Bruise/ Abrasion	B-2
04 Complaint of Pain-	01, 02, 04-12 Any Entry(Except Eye)	08 Complaint of Pain	C-1
( - )	( - ) = N/A	( - )	O-0
Blank	Blank	Blank	O-0
00 = Unknown	00 = Unknown	00 = Unknown	-9

**New York**

<b>Location of Most Severe Physical Complaint [PAR Column 14]</b>	<b>Type of Physical Complaint [PAR Column 15]</b>	<b>Victim's Physical Condition [PAR Column 16]</b>	<b>NASS Scheme/ Code</b>
1-12 Any Entry	1-14 Any Entry	1 Apparent Death	K-4
1-12 Any Entry	Any Entry	2 Unconscious 3 Semi-Conscious 4 Incoherent	A-3
1-12 Any Entry	1 Amputation 2 Concussion 3 Internal 5 Severe Bleeding 7 Moderate Burn 8 Severe Burn, 9 Fracture-Dislocatio	5 Shock 6 Conscious	A-3
3 Eye	4 Minor Bleeding 6 Minor Burn 12 Complaint of Pain	5 Shock 6 Conscious	A-3
1, 2, 4-12 Any Entry (Except Eye)	4 Minor Bleeding 6 Minor Burn	5 Shock 6 Conscious	B-2
1-12 Any Entry	10 Contusion-Bruise 11 Abrasion	5 Shock 6 Conscious	B-2
2, 4-12 Any Entry (Except Eye)	12 Complaint of Pain 13 None Visible 14 Whiplash	5 Shock 6 Conscious	C-1
1-12 Any Entry or (X) = Unknown	13 None Visible	6 Conscious or ( - )	C-1
1, 2, 4-12 Any Entry (Except Eye)	(X) = Unknown	6 Conscious	C-1
Blank or ( - )	13 None Visible or ( - )	6 Conscious	O-0
Blank or ( - )	Blank or ( - )	Blank or ( - )	O-0
(X) = Unknown	(X) = Unknown	(X) = Unknown	-9

<b>State</b>	<b>PAR Code/Definition</b>		<b>NASS Scheme/ Code</b>
<b>Pennsylvania</b>			
	1	= Killed	K - 4
	2	= Major Injury	A - 3
	3	= Moderate Injury	B - 2
	4	= Minor Injury	C - 1
	0	= Not Injured	O - 0
	8	= Injury, Unknown Severity	- 5
	9	= Unknown if Injury	- 9
<b>Texas</b>			
	4	= Killed	K - 4
	1	= Incapacitating Injury	A - 3
	2	= Non-Incapacitating Injury	B - 2
	3	= Possible Injury	C - 1
	5	= Not Injured	O - 0
		= Not Set Unknown Code	- 9
<b>Washington</b>			
	1	= No Injury	O - 0
	2	= Dead at Scene	K - 4
	3	= Dead on Arrival	K - 4
	4	= Dead at Hospital	K - 4
	5	= Disabling	A - 3
	6	= Non Disabling (Evident Injury)	B - 2
	7	= Possible Injury	C - 1
	0	= Unknown	U - 9

**MORTALITY**

**Screen Name:** Mortality

**SAS Data Set:** OA

**SAS Variable:** MORTLTY

**Oracle Name:** OCCUPANTINJURY.PICKMORTALITY

**Element Attributes:**

Oracle	SAS	
1	0	Not Fatal
2	1	Fatal
3	2	Fatal — ruled disease (specify)

**Source:** Researcher determined — inputs include interviewee, police report, and medical records.

**Remarks:**

Official sources (if they exist) take precedence over interview data.

**Not Fatal**

is used when death does not occur or occurs more than 30 days after the crash.

**Fatal**

is used when death occurs within 30 days of the crash. Death must have occurred as a consequence of injuries sustained in the traffic crash. Interview information alone should not be sufficient to select this attribute.

**Fatal — ruled disease (specify)**

is used in two situations. The first is when the effects of a disease can be deemed as a cause of the crash. Cause means that the on-set of the disease occurred prior to the first harmful event. When determining the time of on-set (relative to the first harmful event), the researcher can use any information source available. The researcher makes his/her determination after weighing all the evidence. (**NOTE:** The use of all available information sources is restricted to the determination of when the on-set occurred.)

Second is when a medical examiner (or other official vested by the state to verify the cause of death) or an official medical report verifies that the death resulted from either (1) a diseased condition, or (2) not from crash related injuries.

**TREATMENT**

**Screen Name:** Treatment

**SAS Data Set:** *OA*

**SAS Variable:** *TREATMNT*

**Oracle Name:** *OCCUPANTINJURY.PICKINITIALTREATMENT*

**Element Attributes:**

Oracle	SAS	
0	0	No treatment
8	1	Dead on Arrival (DOA) at hospital
10	2	Dead Prior To Admission
1	3	Hospitalization
2	4	Transported and released
3	5	Treatment at scene - non-transported
4	6	Treatment later
6	7	Transported to a medical facility - unknown if treated
5	8	Treatment - other (specify)
7	9	Unknown

**Source:** Researcher determined — inputs include interviewee, police report, and medical records.

**Remarks:**

Official sources (if they exist) take precedence over interview data.

**No treatment**

includes persons transported to a hospital but who refuse treatment. A person who is declared dead at the scene of the crash and is not transported to a hospital is coded **No treatment**.

**Dead On Arrival (DOA) at hospital**

includes persons who are transported from the scene to a hospital facility and pronounced dead on arrival **at the hospital**. This means that no treatment was attempted at the hospital facility (e.g., no CPR, no examination, no x-rays, etc.)

**Dead Prior To Admission**

includes persons who are transported from the scene to a hospital facility and treated in the ER, but died prior to admission. See **Hospital Stay** for hospitalization criteria.

**Hospitalization**

is used when hospitalization occurs as a result of injury (need *not* be taken directly to a hospital). See Hospital Stay for hospitalization criteria. Also use this attribute if a person is treated and released, then is subsequently hospitalized as a result of injuries sustained in the crash.

**Transported and released**

is used when the person went *directly* from the crash scene to a treatment facility (hospital, clinic, doctor's office, etc.), and the person *is examined* for injuries at the facility. The person need not have been injured. The means of transportation is *not* a consideration.

**Treatment at scene — non-transported**

includes treatment at scene such as: first aid, self-treatment, EMT treatment, doctor treatment, etc.-- and the person is not transported or does not go to a treatment facility (*e.g.*, doctor, clinic, hospital, etc.) as a result of injuries sustained in this crash.

**Treatment later**

includes only professional treatment (*e.g.*, doctor, clinic, hospital, etc.) where the person:

- did not go directly from the scene to treatment,  
**and**
- was treated and released.

If a person is treated at the scene, is not transported from the scene, and subsequently receives later treatment (without being hospitalized), then use this attribute.

**Treatment — other (specify)**

includes non-professional treatment such as first aid, self-treatment, etc., not at the scene of the crash. If this is used, then Type of Medical Facility (for Initial Treatment), must be assigned Not treated at a medical facility.

**Transported to a medical facility-unknown if treated**

is used when the person went *directly* from the crash scene to a treatment facility (hospital, clinic, doctor's office, etc.), and no other information about treatment is known.

If a person survives the injuries and receives treatment at a hospital, but is not admitted for hospitalization, that person's treatment is either Transported and released or Treatment later, depending upon whether the person went directly or indirectly to the hospital. It does not matter if the person is treated for one hour or twelve, only that the person is released following treatment. Nor does it matter if the treatment begins prior to midnight and spans into the following day.

**TYPE OF MEDICAL FACILITY (FOR INITIAL TREATMENT)**

**Screen Name:** Initial Facility

**SAS Data Set:** *OA*

**SAS Variable:** *MEDFACIL*

**Oracle Name:** *OCCUPANTINJURY.PICKFACILITYTYPE*

**Element Attributes:**

Oracle	SAS	
1	0	Not treated at a medical facility
2	1	Trauma center
3	2	Hospital
4	3	Medical clinic
5	4	Physician's office
6	5	Treatment later at medical facility
7	8	Other (specify)
8	9	Unknown

**Source:** Researcher determined — inputs include police report, interviewee, official records, and the American College of Surgeons classification criteria.

**Remarks:**

The treatment of injuries by a physician immediately (*i.e.*, within one hour) following a crash is of utmost importance in serious injury crashes. In order to assess the quality of immediate care available to the victims in CDS crashes, the following criteria are used to categorize the various treatment facilities. Teams must develop a listing of treatment facilities serving their PSU and categorize each into this variable's scheme. Teams must communicate their list to their respective zone center.

**Not treated at a medical facility**

is used when the person was not injured or receives nonprofessional treatment such as first-aid, self-treatment, etc. In addition, use this attribute for persons who "died" at the scene or "died in-route" to a medical facility. Treatment at the scene or in-route to a medical facility by emergency medical personnel is *not* considered initial treatment for the purposes of this variable. This is true even if the facility has radio communications with their EMTs. If a person arrives at a medical facility and subsequently dies or is declared dead after some treatment, but prior to admission, then use one of the other attributes. For example, an occupant arrives with no vital signs, CPR in progress, and a "flat" EKG and is declared "dead on arrival" on the ER report.



**Trauma center**

is used when the occupant was initially treated at a Level I or Level II Trauma Center as defined by the American College of Surgeon's Committee on Trauma's "Resources for optimal care of the injured patient: 2006."

The fact that a medical facility calls itself a "Trauma Center" or something of the same nature does not mean that it satisfies the criteria for Trauma center. The facility must meet the criteria as noted in the preceding paragraph. Most states have legislation which determines the process for designation of Trauma Centers within their state. The ACS describes that responsibility as "a geopolitical process by which empowered entities, government or otherwise, are authorized to designate." Teams should contact their "hospitals" and ask each what they consider themselves to be (according to criteria referenced above). Teams should also be alert for communication releases (*i.e.*, newspapers, radio, TV, etc.) which concern the trauma capability status of their area emergency rooms. **If the status of a hospital should change, notify your Zone Center.**

**Hospital**

is used for all "hospitals" which do not fall into the definition of a Level I or Level II Trauma Center as defined.

**Medical clinic**

is used for treatment facilities which provide outpatient medical care with related in-house laboratory facilities (e.g, x- ray). These are usually a group practice in which several physicians work cooperatively. This also includes school clinics, work place clinics, or similar facilities if they are staffed by a physician while open. If a doctor is not normally present at a clinic while it is open, then the appropriate attribute is Other.

**Physician's office**

is used when the person is initially treated in an office of a professional health care provider which does not qualify for Trauma center, Hospital, or Medical clinic.

**Treatment later at medical facility**

includes only professional treatment (*e.g.*, doctor, clinic, hospital, etc.) where the person:

- did not go directly from the scene to treatment,  
**and**
- was treated and released.

If a person is treated at the scene, is not transported from the scene, and subsequently receives later treatment (without being hospitalized), then use this attribute.

**Other (specify)**

is used when a health care provider's facility is used for the initial treatment, and the facility does not qualify as a Trauma center, Hospital, Medical clinic, or Physician's office above.

Type of Medical Facility (for Initial Treatment) (cont'd)

Page 3 of 3

**Unknown**

is used when it is unknown what type of initial treatment facility was used or when it is unknown if treatment of any kind was obtained.

**HOSPITAL STAY**

**Screen Name:** Hospital Stay

**SAS Data Set:** *OA*

**SAS Variable:** *HOSPSTAY*

**Oracle Name:** *OCCUPANTINJURY.NUMDAYSHOSPITALIZED*

**Element Attributes:**

Oracle	SAS	
	0	Not hospitalized Enter the number of days (up through 60)
	61	61 days or more
-9999	99	Unknown

**Source:** Researcher determined — inputs include interviewee and medical reports.

**Remarks:**

Official sources (if they exist) take precedence over interview data.

**Not hospitalized**

is used when the person was not injured or injured but not admitted to the facility (*i.e.*, admission to the facility's emergency room is not "admission" to the facility for the purposes of the hospitalization question). In addition, use this attribute if fatal at scene, pronounced dead on arrival, or survival does not extend beyond the emergency room.

The basis for the number of days is an overnight criterion. Every time a person remains past midnight subsequent to admission, it is one day. However, there are two exceptions. One exception occurs when a person dies on the same day as the admission. In this situation, 1 is entered. The other exception occurs when a person is *admitted* in the early morning hours (between midnight and 7:00 a.m.), usually for observation, and is subsequently released later in the same day (usually late morning or early afternoon) 1 is entered because the person was hospitalized, Treatment equals Hospitalized.

If your information indicates that the person died while in a critical care unit [*e.g.*, intensive (*i.e.*, ICU), coronary (*i.e.*, CCU), etc.], then at least 1 is entered even if the person expires on the same day. In other words, a person is considered admitted if they are still alive when they are transferred to a critical care unit. On the other hand, in the event that the person survives the emergency room but subsequently dies during surgery, then Not hospitalized is used, because a person who goes directly from the emergency room to an operating room is not considered to have been admitted.

If a person is admitted, lives four days in the hospital, and subsequently expires, enter 4.

This variable reports the number of days this occupant is hospitalized at a primary care facility. Primary care facilities includes medical facilities that receive patients via air transfer (*e.g.*, "lifeline" and "med-evac"). However, the number of days spent at secondary care facilities (*i.e.*, rehabilitation or convalescent units, centers, facilities; or nursing homes) are **not** included in this variable.

**WORKING DAYS LOST**

**Screen Name:** Work Days Lost

**SAS Data Set:** OA

**SAS Variable:** WORKDAYS

**Oracle Name:** OCCUPANTINJURY.PICKWORKINGDAYSLOST

**Element Attributes:**

Oracle	SAS	
	0	No working days lost
		Enter the number of days (up through 60)
	61	61 days or more
	62	Fatally injured
-8888	97	Not working prior
-9999	99	Unknown

**Source:** Primary source is the interviewee; a secondary source is the person's employer.

**Remarks:**

Report the actual number of "work" days lost due to the crash by an employed person or a full-time college student. Children, adolescents, retirees, or unemployed persons are included in **Not working prior to crash**.

If no interview is obtained, assume that persons over 65 or under 17 are not employed full-time; for these persons Not working prior to crash is used unless the person is fatally injured.

Employed is defined to mean that the person was scheduled to work at least four hours on each of the days lost. Each such day is counted as a full day so long as the person was scheduled to work at least four hours on the day lost. Do **not** accumulate the hours and convert to equivalent full-time days; however, if the person works less than full-time but greater than four hours per day annotate "part-time" or "PT".

If during the interview a reasonable projection of future days lost can be made, then add those days to those already known to have been lost. If a reasonable projection cannot be made, then select Unknown.

- The days lost need not be due to injury.
- Days lost include Saturdays, Sundays, and afternoon and evening shifts if so scheduled. Do not count double shifts or days at time and one-half pay, etc., as more than one day.

- If the reported work days lost includes a fraction, round one-half ( $\frac{1}{2}$ ) day or greater up to a whole day. Less than one-half day is excluded (rounded down).
- If someone loses their job as a result of the crash, then count only the work days lost between the crash and the date of termination, inclusive.
- Do not include days lost by persons who were not directly involved in the crash but who lost days because of it (*e.g.*, husband who was not in crash but stayed home to take care of wife who was injured and required assistance).
- If an involved person changes their work schedule as a result of a crash (*e.g.*, to take care of someone injured in the crash), then the work time, which was given up as a result of the crash, shall not be considered as lost.

**Not working prior to crash**

is used when a person is not employed, not a full-time college student, or works less than four hours per day. This includes all persons (except fatals) who do not qualify to lose working days.

INJURY-ZONE

Occupant Form, Case #2006-903-7025/Vehicle # 1/Occupant #1

OCCUPANT | EJECTION | ENTRAPMENT | SEAT | AIR BAG | CHILD SEAT | SEAT BELT | INJURY | INJURY CODES | LOG | REVIEW

PSU | ZONE

Death - Date: [ ] Time: [ ]

Time to Death: [ ] [Not Fatal](#) hrs. (NASS - Valid only within 30 days)

Num Injuries: [ 2 ]

GCS: [ ]

Occupant Given Blood: [ ]

ABG(HCO3): [ ]

Medically Reported Cause Of Death [Ctrl I = Insert Cause of Death](#)

Order	Injury
▶	

Save Close

**DEATH DATE**

**Screen Name:** Death - Date

**SAS Data Set:** N/A

**SAS Variable:** N/A

**Oracle Name:** *OCCUPANTINJURY.DEATHDATE*

**Element Attributes:**

Enter Date of Death

**Source:** Zone Center determined from police report, hospital/medical records, autopsy report, or other official records for actual date of death for fatally injured occupants.

**Remarks:**

Enter the date that the occupant died.



**DEATH TIME****Screen Name:** Time**SAS Data Set:** N/A**SAS Variable:** N/A**Oracle Name:** ***OCCUPANTINJURY.DEATHTIME*****Element Attributes:**

Enter Time of Death, 0001-2400 hours

**Source:** Zone Center determined from police report, hospital/medical records, autopsy report, or other official records for actual time of death for fatally injured occupants.**Remarks:**

Enter the time that the occupant died using the 24 hour military clock. Do not use the 0000 hours time.

**[TIME TO DEATH]****Screen Name:** Time to Death**SAS Data Set:** *OA***SAS Variable:** *DEATH***Oracle Name:** *OCCUPANTINJURY.TIMETODEATH***Element Attributes:**

Oracle	SAS	
-8887	0	[Not Fatal]
	1-24	[Hours to death]
	31-60	[1 day to 30 days]
-8888	96	[Fatal, ruled disease]
-9999	99	[Unknown]

**Source:** Zone Center determined from police report, hospital/medical records, autopsy report, or other official records for actual time of death for fatally injured occupants.**Range:** 0, 1-24, 31-60, 96, 99**Remarks:**

Enter date and time of death. The system computes the time to death based on the crash date and the date and time of death entered previously. This value is valid in NASS only up to 30 days.

**[NUMBER OF INJURIES FOR THIS OCCUPANT]**

**Screen Name:** Num Injuries

**SAS Data Set:** *OA*

**SAS Variable:** *INJNUM*

**Oracle Name:** *DERIVED*

**Element Attributes:**

0 [No injuries]  
[The actual number of injuries recorded for this occupant will be rolled up]  
97 [Injured, severity unknown]  
99 [Unknown if injured]

**Source:** Zone Center determined — inputs include official medical records and interviewee data from the PSU and PAR (see limitations below).

**Range:** 0, 1- 95, 97, 99

**Remarks:**

The system rolls the number of injuries coded in the NASSINJURY program to the number of injuries variable.

No injuries are recorded by the system when no injuries have been coded in the NASSINJURY program.

## GLASGOW COMA SCALE (GCS) SCORE (AT MEDICAL FACILITY)

Page 1 of 2

Screen Name: GCS

SAS Data Set: OA

SAS Variable: GLASGOW

Oracle Name: OCCUPANTINJURY.PICKGCSSCORE

## Element Attributes:

Oracle	SAS	
0	0	Not injured
1	1	Injured — not treated at medical facility
2	2	No GCS Score at medical facility
3-15	3-15	Enter the actual value of the initial GCS Score recorded at medical facility
97	97	Injured, details Unknown
99	99	Unknown if injured

Source: Zone Center determined from official medical records.

## Remarks:

Report the actual value of the *initial* GCS score obtained at a medical facility. The Glasgow Coma Scale assesses three neurological functions: **eye opening**, **motor response**, and **verbal response**. The GCS value can often be found in medical records by looking for the abbreviation "GCS". The number following the abbreviation is the score unless the value is less than "03" or greater than "15". It is not uncommon to find the GCS Score accompanied by information about eye pupil size and motor strength.

If more than one Glasgow Coma Scale (GCS) Score is recorded in the document without reference to initial GCS Score, then select the GCS Score to be entered in the following order:

- (a) enter the GCS Score from the medical record with the earliest time to hospital treatment (*i.e.*, enter ER record over discharge summary)
- (b) enter the GCS Score that appears first in a medical record other than the ER record
- (c) if two or more GCS Scores are recorded in the same record without reference to time, enter the lowest GCS Score.

"15" is entered when the occupant's medical record does not specifically indicate the GCS Score but does indicate one or more of the following pieces of information:

- AxOx3 (alert and oriented times three)
- neurologically intact, normal, etc., or
- CN II-XII okay, normal, intact, etc.

**Injured — not treated at medical facility**

is used when the person was injured and received only nonprofessional treatment such as first-aid, self-treatment, etc., or was treated at the scene by emergency medical personnel. In addition, use this for persons who "died" at the scene or "died in-route" to a medical facility. This is true even if the medical facility has radio communications with the emergency medical personnel.

**No GCS Score at medical facility**

is used when the occupant was injured and received professional medical treatment but no Glasgow Coma Scale Score was assessed or recorded at a medical facility. Use this if the only GCS Score obtained was reported on an emergency medical report. If GCS Scores are obtained by both emergency medical personnel and at a medical facility, then report the initial score obtained at the medical facility.

Use this attribute if a person was treated at a medical facility and their medical records are pending.

**Injured, details unknown**

is used when the occupant was injured but the details of the injuries are unknown.

**Unknown if injured**

is used when the PAR injury severity is "C-injury" and there is no interview and it is unknown if the person received medical treatment.

**WAS THE OCCUPANT GIVEN BLOOD?**

**Screen Name:** Occupant Given Blood?

**SAS Data Set:** *OA*

**SAS Variable:** *BLOOD*

**Oracle Name:** *OCCUPANTINJURY.BLOODGIVENUNITS*

**Element Attributes:**

Oracle	SAS	
0	0	No blood given
1	1	1 unit given
2	2	2 units given
3	3	3 units given
4	4	4 units given
5	5	5 units given
6	6	6 units given
7	7	7 units given
8	8	8 units given
9	9	9 units given
10	10	10 or more units given
11	97	Blood given, # units unknown
-99	99	Unknown if blood given

**Source:** Zone Center determined from official medical records or Emergency Medical Service (EMS) reports.

**Remarks:**

In general, blood consists of red blood cells (erythrocytes), white blood cells (leukocytes) and platelets (thrombocytes) suspended in plasma. In a transfusion, blood can be given in four separate forms: whole blood, packed red blood cells, plasma, or platelets; or in a combination of these forms.

**Whole blood**

is blood from which none of the elements have been removed.

**Packed red blood cells**

are whole blood from which plasma has been removed.

**Plasma**

is the fluid (pale yellow liquid) of the blood in which the particulate components are suspended. Plasma is often given to burn patients.

Was the Occupant Given Blood? (cont'd)

Page 2 of 2

**Platelets**

are known for their role in blood coagulation. Platelets are often given when blood clotting is desired.

**No blood given**

is used whenever, Glasgow Coma Scale (GCS) Score equals Not injured or Injured - not treated at medical facility, or it is known that the person did not receive any professional treatment. In addition, use this when:

- it is known that the occupant was injured and not given blood; or
- an occupant is transported and released **and** not subsequently hospitalized independent of whether the occupant's records are acquired.

**Enter the number of units of blood**

when this occupant was given "blood" in any of the four forms, or combinations, discussed above for injuries sustained as a result of their motor vehicle traffic crash. **Excluded** are transfusions which result from noninjury. For example, if a spontaneous abortion results to a mother who was not injured, but who was given a transfusion, then do not consider this occupant to have had blood given. Whenever an occupant is "taken to surgery" researchers should be alert to the possibility that a blood transfusion occurred. Whenever a transfusion occurs, select the number of units of blood given.

**Blood given, # units unknown**

is used when this occupant was given blood, but the amount was not specified.

**Unknown if blood given**

use this when the occupant is:

- injured and treated at a medical facility but it cannot be determined if blood was given.
- hospitalized **and** the occupant's records are inconclusive regarding whether blood was given;
- taken to surgery, regardless of hospitalization (*e.g.*, died prior to being hospitalized), **and** the occupant's records are inconclusive regarding whether blood was given; or
- hospitalized **or** taken to surgery **and** the medical records are pending.

**ARTERIAL BLOOD GASES -- ABG (HCO3)**

**Screen Name:** ABG (HCO3)

**SAS Data Set:** OA

**SAS Variable:** BICARB

**Oracle Name:** OCCUPANTINJURY.PICKABGRESULTS

**Element Attributes:**

Oracle	SAS	
0	0	Not injured
1	1	Injured, ABGs not measured or reported
2-50	2-50	ABG=2, 3, 4, , , . . . . , 50
96	96	ABGs reported, HCO <sub>3</sub> unknown
97	97	Injured, details unknown
99	99	Unknown if injured

**Source:** Zone Center determined from official medical records.

**Remarks:**

The table below presents the normal measures of arterial blood gases followed by the definitions of these measures and other keywords.

**Arterial Blood Gases (ABGs)**

Measure	Normal	Respiratory Acidosis	Respiratory alkalosis	Metabolic acidosis	Metabolic alkalosis
pH	7.35 to 7.45	Normal or Decreased	Increased	Decreased	Increased
PO <sub>2</sub>	90 to 95 mm Hg	Decreased	Altered	Normal or increased	Normal or decreased
PCO <sub>2</sub>	34 to 46 mm Hg	Increased	Decreased	Decreased	Increased
HCO <sub>3</sub>	24 to 26 mEq/L	Increased	Decreased	Decreased	Increased
RR	10/min to 20/min	Irregular	Altered	Increased	Decreased



**Definitions of Measures**

**pH** — the symbol relating the hydrogen ion (H<sup>+</sup>) concentration or activity of a solution to that of a given standard solution. Numerically the pH is approximately equal to the negative logarithm of H<sup>+</sup> concentration expressed in molarity pH 7 is neutral; above it alkalinity increases and below it acidity increases.

**PO<sub>2</sub>, pO<sub>2</sub>, P<sub>O</sub><sub>2</sub>** oxygen partial pressure (tension).

**PCO<sub>2</sub>, pCO<sub>2</sub>, P<sub>C</sub><sub>O</sub><sub>2</sub>** carbon dioxide partial pressure or tension.

**HCO<sub>3</sub>** bicarbonate radical.

**RR** respiratory rate.

**Alphabetical Definitions of Keywords**

**acidosis** (as"i-do/sis) — a pathologic condition resulting from accumulation of acid or depletion of the alkaline reserve (bicarbonate content) in the blood and body tissues, and characterized by an increase in hydrogen ion concentration (decrease in pH). metabolic a. — a disturbance in which the acid-base status of the body shifts toward the acid side because of loss of base or retention of noncarbonic, or fixed (nonvolatile), acids; called also nonrespiratory a. respiratory a. — a state due to excess retention of carbon dioxide in the body; called also hypercapnic a.

**alkali** (al'kah-li) — any of a class of compounds which form soluble soaps with fatty acids ... and form soluble carbonates.

**alkalosis** (al"kah-lo/sis) — a pathologic condition resulting from accumulation of base, or from loss of acid without comparable loss of base in the body fluids, and characterized by decrease in hydrogen ion concentration (increase in pH). metabolic a. — a disturbance in which the acid-base status of the body shifts toward the alkaline side because of retention of base or loss of noncarbonic, or fixed (nonvolatile), acids. respiratory a. — a state due to excess loss of carbon dioxide from the body.

**anion** (an'i-on) — an ion carrying a negative charge owing to a surplus of electrons.

**bicarbonate** (bi-kar'bo-na t) — any salt containing the HCO<sub>3</sub><sup>-</sup> anion. blood b. — the bicarbonate of the blood, an index of the alkali reserve.

**ion** (i'on) — an atom or radical having a charge of positive (cation) or negative (anion) electricity owing to the loss (positive) or gain (negative) of one or more electrons.

**mEq/L** milliequivalent per liter: a milliequivalent is the number of grams of a solute contained in one milliliter of a normal solution; therefore, the normal range for the bicarbonate of blood is 0.024–0.026 grams per milliliter. Thus, for a thousand milliliters, the normal values become 24 to 26 grams.

Medical records often provide ABG information in a condensed format. For example, a medical record presented the ABG information as follows.

**ABG:7.56 / 25 / 171 / 100 %**

This equates to: pH = 7.56; PCO<sub>2</sub> = 25; PO<sub>2</sub> = 171 -- at 100 percent saturation

In this example, the measure desired is not reported; use ABGs reported, HCO<sub>3</sub> unknown. The measure of interest is the HCO<sub>3</sub> (also referred to as the **bicarbonate**). Researchers must look carefully at their reported ABGs to insure that the desired measure is being obtained. The closeness in range between the normal values of HCO<sub>3</sub> and PCO<sub>2</sub>, makes mistaking them easy. In general, when ABGs are reported as a set of three values, consider them to be the pH, PCO<sub>2</sub>, and PO<sub>2</sub>.

#### **Actual Values**

are used to report the measured HCO<sub>3</sub> (bicarbonate) value obtained for this occupant. If multiple ABG HCO<sub>3</sub> values are reported, enter the lowest value.

#### **Injured, ABGs not measured or reported**

is used when the occupant is injured

*and:*

- (1) was not treated at a medical facility
- (2) was treated at a medical facility but no official medical records were obtained, or
- (3) no ABG measures are reported in any of the occupant's obtained official medical records.

#### **ABGs reported, HCO<sub>3</sub> unknown**

is used when ABG value(s) are reported in this occupant's medical records but the HCO<sub>3</sub> measure is unknown.

**MEDICALLY REPORTED CAUSE OF DEATH**

**Screen Name:** Medically Reported Cause of Death

**SAS Data Set:** *OA*

**SAS Variable:** *DCAUSE1, DCAUSE2, DCAUSE3, DCAUSE4, DCAUSE5*

**Oracle Name:** *CAUSEOFDEATH.PICKCAUSEOFDEATH*

**Element Attributes:**

Oracle	SAS	
	0	Not fatal
	#	Select the injuries which have been identified that reportedly contributed to this occupant's death
-96	96	Mode of death given but specific injuries are not linked to cause of death (specify)
-97	97	Other result (includes fatal ruled disease) (specify)
-99	99	Unknown

**Source:** Zone Center determined from official records

**Range:** 1-95, 96, 97, 99

**Remarks:**

This variable records the injury(s) which was/were determined by the medical professional completing the report, or by trained Zone Center injury coders using official medical records, to be the cause of death. A "cause of death" statement may appear at the beginning or end of an official medical record or it may also appear in a "diagnosis" section or body of a medical record. Like the coding rule for injuries, probable or possible causes of death are not used. If the occupant was killed and no official medical data was obtained, or the data obtained inadequately describes injuries which could have an affect on the occupant's death, then assign cause of death equal to **Unknown**. If the occupant was killed and acquired medical data do not provide a specific official medically reported cause of death, then the Zone Center injury coder will determine if injury data are sufficient to enter the 1<sup>st</sup> cause of death, and/or 2<sup>nd</sup>, and/or 3<sup>rd</sup> with an appropriate injury row(s).

Select the injury(s) which caused the death.

If the "cause of death" statement consist of nonspecific indefinite injuries (e.g., multiple injuries of head, trunk, etc., blunt force injuries of the chest etc., massive injury, and multiple traumatic injuries) and injuries are detailed in the official medical records such that the cause of death can be logically determined, then choose up to three specific injuries using the following guidelines:

- Proceed by first considering specific AIS-6 injuries, followed by AIS-5, then AIS-4, then AIS-3.

Note: AIS levels do not automatically identify an injury as the selected cause of death. For example, if the occupant has an AIS-6 burn injury but the medical says that the occupant was dead prior to the occupant's vehicle catching on fire, then burn was not the cause of death.

- Within each AIS level, determine the contribution the specific injury had on the occupant's chance of survival.

**Mode of death given but specific injuries are not linked to cause of death (specify)**

is used when it is determined that the occupant qualifies for Fatal in variable, Mortality, but specific injuries are not medically reported for the cause of death. The official medical report may give a mode of death such as (1) acute pulmonary embolis, (2) respiratory failure, (3) cardiac arrest, or (4) asphyxiation. This is also used when the cause of death is reported from complications or consequences of injuries.

**Other result (specify)**

is used when it is determined that the occupant qualifies for **Fatal-ruled disease** in **Mortality**.

If no cause of death is directly from an injury and there is no officially reported mode of death, then encode cause of death as **Other-result**.

INJURIES LIST

Occupant Form, Case #2007-996-900015/Vehicle # 2/Occupant #1

OCCUPANT | EJECTION | ENTRAPMENT | SEAT | AIR BAG | CHILD SEAT | SEAT BELT | INJURY | INJURY CODES | LOG | REVIEW

INJURIES | VITAL SIGNS | MANNEQUINS

LIST | DETAIL

Num	AIS Code	Rank	Medical Record Type	Aspects	Injury Source	Confidence	Direct/Indirect	Direct Intrusion

Max AIS

Save Close

INJURIES DETAIL

Occupant Form, Case #2007-996-900015/Vehicle # 2/Occupant #1

OCCUPANT | EJECTION | ENTRAPMENT | SEAT | AIR BAG | CHILD SEAT | SEAT BELT | INJURY | INJURY CODES | LOG | REVIEW

INJURIES | VITAL SIGNS | MANNEQUINS

LIST | DETAIL

NASS Code

Description

Aspect

Source

Area

Element

Confidence Level

Direct Intrusion

Indirect Intrusion

Air Bag Related

Direct/Indirect Injury

Rank

Medical Record Type

**INJURY NUMBER**

**Screen Name:** N/A

**SAS Data Set:** *OI*

**SAS Variable:** *INJNO*

**Oracle Name:** *INJURY.INJURYNUMBER*

**Element Attributes:**

Sequential number assigned by the system to each coded injury.

**Source:** Application assigned field

**Remarks:**

The NASSINJURY application generates a consecutive number for each injury inserted per occupant beginning with the number 1. No duplicate numbers or skipped numbers allowed.

**AIS CODE**

**Screen Name:** NASS Code

**SAS Data Set:** *OI*

**SAS Variable:** *AISCODE*

**Oracle Name:** *INJURY.AISCODES*

**Element Attributes:**

AIS 2005/08 Update codes (7-digit numeric field describing injury)

**Source:** Zone center determined based on the current NASS 2000 Injury Coding Manual; inputs include medical records, interviewee, and PAR data.

**Remarks:**

Select the appropriate NASS injury code using the list of codes developed for use in CDS. For guidance in selecting the appropriate code click on the F10 key. Coding conventions and rules included in the Source document will appear appropriate to the injury code selected.

**INJURY DESCRIPTION**

**Screen Name:** Description

**SAS Data Set:** *OI*

**SAS Variable:** *AISCODE*

**Oracle Name:** *DERIVED*

**Element Attributes:**

Standardized word description of injury code selected in previous variable.

**Source:** Automatically filled based upon prior coding.

**Remarks:**

Description of injury from AIS dictionary section of the 2010 NHTSA Injury Coding Manual. This field is self-populated when an AIS code is entered.



**ASPECT**

**Screen Name:** N/A

**SAS Data Set:** OI

**SAS Variable:** ASPECT05

**Oracle Name:** INJURYASPECT.ASPECTID

**Attributes:**

**Primary**

Oracle	SAS	
1	1	Right
2	2	Left
3	3	Bilateral
4	4	Central
5	5	Anterior/Front/Ventral
6	6	Posterior/Back/Dorsal
7	7	Superior/Upper
8	8	Inferior/Lower
9	9	Unknown
0	0	Whole Region

**Secondary**

Oracle/ SAS		Oracle/ SAS		Oracle/ SAS	
10	Upper Arm	26	C6C7	43	C1
11	Elbow	27	T1T2	44	C2
12	Forearm	28	T2T3	45	C3
13	Wrist	29	T3T4	46	C4
14	Hand/Digits	30	T4T5	47	C5
15	Buttock	31	T5T6	48	C6
16	Thigh	32	T6T7	49	C7
17	Knee	33	T7T8	50	T1
18	Lower Leg	34	T8T9	51	T2
19	Ankle	35	T9T10	52	T3
20	Foot/Toes	36	T10T11	53	T4
21	C1C2	37	T11T12	54	T5
22	C2C3	38	L1L2	55	T6
23	C3C4	39	L2L3	56	T7
24	C4C5	40	L3L4	57	T8
25	C5C6	41	L4L5	58	T9

## Secondary (Cont'd)

Oracle/ SAS	Oracle/ SAS	Oracle/ SAS
59 T10	240 Ventricle	305 Right Eyebrow
60 T11	241 Atria	306 Left Eyebrow
61 T12	250 Right Front	307 Right Forehead
62 L1	251 Left Front	308 Left Forehead
63 L2	252 Right Back	309 Eyelid
64 L3	253 Left Back	310 Mid Forehead
65 L4	260 C7T1	311 Lateral Wall
66 L5	261 T12L1	889 R Rib 1
68 Cauda Equina	262 L5S1	890 R Rib 2
110 Lateral	270 Ascending	891 R Rib 3
121 Medial	271 Descending	892 R Rib 4
200 Head/Face	280 Upper Extremity	893 R Rib 5
201 Cheek	281 Torso	894 R Rib 6
202 Chin	282 Flank	895 R Rib 7
205 Lips	283 Groin	896 R Rib 8
206 Ear	284 Lower Extremity	897 R Rib 9
207 Nose	285 OC1	898 R Rib 10
220 Temporal	286 Arch	899 R Rib 11
221 Medulla	290 Central Front	900 R Rib 12
222 Right Lobe	291 Central Back	901 L Rib 1
223 Hypothalmus	292 Whole Front	902 L Rib 2
224 Parietal	293 Whole Back	903 L Rib 3
225 Midbrain	294 Coccyx	904 L Rib 4
226 Nasal Spine	295 Sacrum	905 L Rib 5
227 Left Lobe	296 Right Ilium	906 L Rib 6
228 Pons	297 Left Ilium	907 L Rib 7
230 Occipital-Right	298 Right Ischium	908 L Rib 8
231 Occipital-Left	299 Left Ischium	909 L Rib 9
232 Anterior Fossa	300 Right Pubic Ramus	910 L Rib 10
233 Middle Fossa	301 Left Pubic Ramus	911 L Rib 11
234 Posterior Fossa	302 Pubic Symphysis	912 L Rib 12
235 Frontal-Right	303 Right Sacroiliac Joint	913 Shoulder
236 Frontal-Left	304 Left Sacroiliac Joint	914 Hip

**Tertiary**

Oracle/ SAS		Oracle/ SAS	
1000	Right Process	1021	Lateral Rib
1001	Left Process	1022	Anterio-lateral Rib
1010	Stable	1023	Posterior-lateral Rib
1011	Unstable	1024	Posterior Rib
1020	Anterior Rib		

**Source:** Zone Center determined--inputs include interviewee, medical records, and PAR data.

**Remarks:**

One primary aspect must be selected for each injury.

Prior to 2004, aspects for location of injuries were limited to ten attributes (shown as Primary in the list above). The aspect codes are linked to NASS AIS codes based on valid combinations developed for use in the NASS CDS system. In 2004 secondary aspects codes were added to better identify the exact location of the injury. Coding of tertiary aspects began in 2010.

**Rules for coding secondary aspects:**

- Code secondary aspects for bone injuries to the rib cage.
- Code secondary aspects for injuries to the spinal column.
- Code secondary aspects for integumentary injuries involving extremities.
- The secondary aspect should be included if the medical record specifies. The injuries with secondary aspects will include injuries beginning with NASS AIS codes: 45 (only rib cage, not sternum), 63, 64, 65, 79, 89
- Secondary aspects are optional but may be multiple in the case of rib and integumentary injuries.
- Instances where two bone injuries to the rib cage have different secondary aspects (e.g. Left Rib 1 and Right Rib 4) and a single source should be coded as one injury with a bilateral primary aspect. The secondary aspects must also be included.
- Extremity integumentary injuries that have a bilateral primary aspect should only have secondary aspects listed if the same secondary aspect exists on both sides. For example: contusions to the right thigh and left lower leg would be coded as bilateral primary aspect but no secondary aspects.

**SOURCE/AREA**

**Screen Name:** Source - Area  
**SAS Data Set:** N/A  
**SAS Variable:** N/A  
**Oracle Name:** *INJURY.INJURYCATID*

**Element Attributes:**

Oracle	SAS
1	Front
2	Left Side
15	Left Door Panel
3	Right Side
16	Right Door Panel
4	Interior
5	Air Bag
6	Roof
7	Floor
8	Rear
9	Adaptive (Assistive) Driving Equipment
10	Exterior of Occupant's Vehicle
11	Exterior of Other Motor Vehicle
12	Other Vehicle or Object in the Environment
13	Noncontact Injury
14	Injured, unknown source

**Source:** Zone Center determined--inputs include vehicle inspection, interviewee, and medical records.

**Remarks:**

Categorization of the injury source list into groups inside and external to the vehicle provides a means for easier selection of the individual component. Selection of the source area leads to filtering of the attribute list in the Source/Element variable.

**Injured, unknown source**

This code is used in situations where there is no source for determining the injury mechanism, i.e. no inspection, interview or medical records are available. Selection of this attribute automatically codes the dependent variables.

“Injured, unknown source” may be used when the vehicle is inspected and:

- The vehicle has all interior components destroyed by fire or damaged such that no contact evidence can be collected;
- Occupant injuries are so severe, e.g. torso transaction, etc. that reconstruction of the injury mechanism is impossible;
- Vehicle is completely repaired.

**AIR BAG LOCATION**

**Screen Name:** Air Bag Location

**SAS Data Set:** N/A

**SAS Variable:** N/A

**Oracle Name:** ***INJURY.AIRBAGRELATEDID***

**Element Attributes:**

[Not air bag related]  
<Seat position>-<Bag type>  
Unknown Airbag

**Source:** Zone Center determined--inputs include vehicle inspection, interviewee, and medical records.

**Remarks:**

This variable displays only when Air Bag is selected in Source – Area. After the variable space opens, a list of all air bags associated with the vehicle appears. The appropriate air bag for the injury can then be selected.

## INJURY SOURCE

Page 1 of 5

Screen Name: N/A

SAS Data Set: OI

SAS Variable: INJSOU

Oracle Name: INJURY.PICKINJURYSOURCE

## Element Attributes:

## Element Values:

Oracle SAS

## FRONT

1	1	Windshield
2	2	Mirror
3	3	Sunvisor
4	4	Steering wheel rim
5	5	Steering wheel hub/spoke
6	6	Steering wheel (combination of rim and hub/spoke)
7	7	Steering column, transmission selector lever, other attachment
8	8	Cellular telephone or CB radio
9	9	Add on equipment <i>e.g.</i> , tape deck, air conditioner)
13	13	Glove compartment door
15	15	Windshield including one or more of the following: front header, A A1/A2)-pillar, instrument panel, mirror, or steering assembly driver side only)
16	16	Windshield including one or more of the following: front header, A A1/A2)-pillar, instrument panel, or mirror (passenger side only)
17	17	Windshield reinforced by exterior object (specify)
19	19	Other front object (specify):
20	20	Sunvisor reinforced by front header (specify)
21	21	Left instrument panel
22	22	Center instrument panel
23	23	Right instrument panel
24	24	Left lower instrument panel (includes knee bolster)
25	25	Center lower instrument panel (includes knee bolster)
26	26	Right lower instrument panel (includes knee bolster)

## LEFT SIDE

53	53	Left A (A1/A2)-pillar
54	54	Left B-pillar
55	55	Other left pillar (specify):

56	56	Left side window glass
57	57	Left side window frame
58	58	Left side window sill
59	59	Left side window glass including one or more of the following: frame, window sill, A (A1/A2)-pillar, B-pillar, or roof side rail.
60	60	Other left side object (specify)
61	61	Left side glass (laminated) reinforced by exterior object (specify)
62	62	Left side panel forward of A1/A2 pillar
63	63	Left side panel rear of the B-pillar

**LEFT DOOR PANEL**

73	73	Left forward upper quadrant
74	74	Left forward lower quadrant
75	75	Left rear upper quadrant
76	76	Left rear lower quadrant
77	77	Left hardware/armrest forward upper quadrant
78	78	Left hardware/armrest forward lower quadrant
79	79	Left hardware/armrest rear upper quadrant
80	80	Left hardware/armrest rear lower quadrant

**RIGHT SIDE**

103	103	Right A (A1/A2)-pillar
104	104	Right B-pillar
105	105	Other right pillar (specify):
106	106	Right side window glass
107	107	Right side window frame
108	108	Right side window sill
109	109	Right side window glass including one or more of the following: frame, window sill, A (A1/A2)-pillar, B-pillar, or roof side rail.
110	110	Right side glass (laminated) reinforced by exterior object (specify)
111	111	Other right side object (specify)
112	112	Right side panel forward of A1/A2 pillar
113	113	Right side panel rear of the B-pillar

**RIGHT DOOR PANEL**

121	121	Right forward upper quadrant
122	122	Right forward lower quadrant
123	123	Right rear upper quadrant
124	124	Right rear lower quadrant
125	125	Right hardware/armrest forward upper quadrant
126	126	Right hardware/armrest forward lower quadrant



127 127 Right hardware/armrest rear upper quadrant  
128 128 Right hardware/armrest rear lower quadrant

**INTERIOR**

151 151 Seat, back support  
152 152 Belt restraint webbing/buckle  
153 153 Belt restraint B-pillar or door frame attachment point  
154 154 Other restraint system component (specify):  
155 155 Head restraint system  
160 160 Other occupants (specify):  
161 161 Interior loose objects (specify):  
163 163 Other interior object(s) (specify):  
164 164 Center console first row  
165 165 Center console second row  
166 166 Center console other row  
167 167 Fold down armrest first row  
168 168 Fold down armrest second row  
169 169 Fold down armrest other row  
271 271 Child safety seat shell, (i.e., Shell interior, exterior, base, cup holder,  
padding, head restraint, handle)  
272 272 Child safety seat harness system, (i.e., Harness system straps, retainer clip, t-  
shield, tray-shield, shield, latchplate, buckle  
273 273 Unknown child safety seat component  
570 570 Same occupant contact (specify) (ex. knee)  
572 572 Seat latch points for child restraints  
573 573 Grab handles  
574 574 Engine shroud/cover  
575 575 Seatback trays  
576 576 Cargo in vehicle

**ROOF**

201 201 Front header  
202 202 Rear header  
203 203 Roof left side rail  
204 204 Roof right side rail  
205 205 Roof or convertible top  
206 206 Roof map light/console  
207 207 Sunroof/components'  
208 208 Roll bar

**FLOOR**

251 251 Floor (including toe pan)  
252 252 Floor or console mounted transmission lever, including console  
253 253 Parking brake handle

254 254 Foot controls including parking brake

**REAR**

301 301 Backlight (rear window)  
302 302 Backlight storage rack, door, etc.  
303 303 Other rear object (specify):

**AIR BAG**

320 320 Air bag  
321 321 Air bag and eyewear  
322 322 Air bag and jewelry  
323 323 Air bag and object held  
324 324 Air bag and object in mouth  
325 325 Air bag compartment cover  
326 326 Air bag compartment cover and eyewear  
327 327 Air bag compartment cover and jewelry  
328 328 Air bag compartment cover and object held  
329 329 Air bag compartment cover and object in mouth

**ADAPTIVE (ASSISTIVE) DRIVING EQUIPMENT**

401 401 Hand controls for braking/acceleration  
401 402 Steering control devices (attached to OEM steering wheel)  
403 403 Steering knob attached to steering wheel  
405 405 Replacement steering wheel (*i.e.*, reduced diameter)  
406 406 Joy stick steering controls  
407 407 Wheelchair tie-downs  
408 408 Modification to seat belts,(specify):  
409 409 Additional or relocated switches, (specify):  
410 410 Raised roof  
411 411 Wall mounted head rest (used behind wheel chair)  
412 412 Other adaptive device (specify):

**EXTERIOR OF OCCUPANT'S VEHICLE**

451 451 Hood  
452 452 Outside hardware (*e.g.*, outside mirror, antenna)  
453 453 Other exterior surface or tires (specify):  
454 454 Unknown exterior objects

**EXTERIOR OF OTHER MOTOR VEHICLE**

501 501 Front bumper  
502 502 Hood edge  
503 503 Other front of vehicle (specify):  
504 504 Hood  
505 505 Hood ornament  
506 506 Windshield, roof rail, A-pillar  
507 507 Side surface  
508 508 Side mirrors  
509 509 Other side protrusions (specify):

Injury Source (cont'd)

510	510	Rear surface
511	511	Undercarriage
512	512	Tires and wheels
513	513	Other exterior of other motor vehicle (specify):
514	514	Unknown exterior of other motor vehicle

**OTHER VEHICLE OR OBJECT**

551	551	Ground
598	598	Other object (specify):
599	599	Unknown object (specify)
552	598	Tree
553	598	Pole
554	598	Traffic barrier (includes: jersey barrier, guardrail, etc.)

**NONCONTACT INJURY**

601	601	Fire in vehicle
602	602	Flying glass
603	603	Other noncontact injury source (specify):
604	604	Air bag exhaust gases
697	697	Injured, unknown source

**Source:** Zone Center determined--inputs include vehicle inspection, interviewee, and medical records

**Remarks:**

Code the attribute that caused the injury, disregarding any reinforcement by other objects. Use all available information including occupant kinematics, posture, and safety system function to select the component.

**Cargo**

is described as cargo inside the vehicle. Examples: spare tire, construction equipment, tools and tool box(es).

**Air bag compartment cover**

is the flap(s) portion of a deployed air bag.

**CONFIDENCE**

**Screen Name:** Confidence Level

**SAS Data Set:** *OI*

**SAS Variable:** *SOUCON*

**Oracle Name:** *INJURY.PICKSOURCECONFIDENCELEVEL*

**Element Attributes:**

Oracle	SAS	
1	1	Certain
2	2	Probable
3	3	Possible
9	9	[Unknown]

**Source:** Zone Center determined--inputs include vehicle inspection, interviewee, and medical records.

**Remarks:**

The intent of this variable is to give analysts an assessment of the likelihood the injury source coded by the injury coder actually caused the injury.

**Certain**

This code is used when the coder has a very strong indication that a particular component caused the injury, given the occupant location, vehicle dynamics, and injury mechanism. This code may also be used in cases with little or no physical evidence where the vehicle dynamics and occupant injuries indicate only one possible scenario

**Probable**

This code is used when a reasonable interpretation of injury causation can be approximated. There is some evidence present but source could be attributed to more than one component.

**Possible**

This code is used when there is no supporting physical evidence but factors point to an area of the vehicle or an object as the injury source. Contact points, detailed injury information or occupant demographics are missing. A scenario exists but cannot be verified with the information available.

**Unknown**

This code is used in situations where there is no source for determining the injury mechanism, i.e. no inspection, interview or medical records are available.

Unknown may be used when the vehicle is inspected and:

- The vehicle has all interior components destroyed by fire or damaged such that no contact evidence can be collected;
- Occupant injuries are so severe, e.g. torso transaction, etc. that reconstruction of the injury mechanism is impossible;
- Vehicle is completely repaired.
- 

This attribute is automatically entered when “Injured, unknown source” is entered in SOURCE/Area.

**DIRECT INTRUSION**

**Screen Name:** Direct Intrusion

**SAS Data Set:**

**SAS Variable:**

**Oracle Name:** *INJURY.DIRECTINTRUSIONID*

**Element Attributes:**

< Select appropriate intrusion from list >

Not directly related to intrusion

Unknown

**Source:** Zone Center determined--inputs include vehicle inspection, interviewee, and medical records.

**Remarks:**

Injuries directly related to intrusion occur when the intruding component directly contacts the occupant causing injury.

If intrusions exist, this variable space will display a filtered list of intrusions for the vehicle based on the Source/Element

There is not a one to one relationship between the list of possible intruding components and the list of injury sources. Table A-15 defines the relationship between the list of intrusions and their associated injury source. Refer to table at the end of this section of manual for the correct combinations.

**Not directly related to intrusion**

Use this attribute for injuries assigned to components that have not intruded. If there are no intrusions listed for this vehicle, this attribute is automatically coded.

**Unknown**

Use this attribute when the vehicle was not inspected. This attribute is also used for injuries when it is not possible to identify the injury source.

**INDIRECT INTRUSION**

**Screen Name:** Indirect Intrusion

**SAS Data Set:**

**SAS Variable:**

**Oracle Name:** *INJURY.INDIRECTINTRUSIONID*

**Element Attributes:**

<Select appropriate intrusion from list>  
Not directly related to intrusion  
Unknown

**Source:** Zone Center determined--inputs include vehicle inspection, interviewee, and medical records.

**Remarks:**

Indirect intrusions are where the intruding component reinforces a Source/Element causing injury.

If intrusions exist for an occupant's vehicle, this variable will display all intrusions. Unlike Direct Intrusion, the injury source may not be related to the intruding component.

**Not indirectly related to intrusion**

Use this attribute for injuries that are not indirectly associated with an intrusion.

**Unknown**

Use this attribute when the vehicle was not inspected. This attribute is also used for injuries when it is not possible to identify the injury source.

**AIR BAG RELATED**

**Screen Name:** Air bag related

**SAS Data Set:**

**SAS Variable:**

**Oracle Name:** *INJURY.AIRBAGRELATEDID*

**Element Attributes:**

Injury not air bag related  
Select appropriate air bag location  
Injured, unknown source

**Source:** Zone Center determined--inputs include vehicle inspection, interviewee, and medical records.

**Remarks:**

Air bag related is coded when a body part set in motion by a deploying air bag contacts a component which produces and injury. These are commonly referred to as “fling” injuries.

For example, a driver has their left arm on the steering wheel when the steering wheel air bag deploys. The deploying air bag directs the left arm into the A-pillar and contact with the A-pillar fractures the arm.

This variable identifies the air bag that causes the acceleration. This variable will list all those air bags which have been entered through the Occupant or Safety Systems form.

DO NOT use airbag related in instances where the air bag directly causes an injury.

**Injury not air bag related**

Air bag either directly caused the injury or did not accelerate the body part into another vehicle component.

**<Injury, unknown source>**

Automatically system coded when the Injury Source is coded **Injury, unknown source**.



**DIRECT/INDIRECT INJURY**

**Screen Name:** Direct/Indirect Injury

**SAS Data Set:** *OI*

**SAS Variable:** *DIRINJ*

**Oracle Name:** *INJURY.PICKDIRECTINDIRECTINJURY*

**Element Attributes:**

Oracle	SAS	
1	1	Direct contact injury
2	2	Indirect contact injury
3	3	Noncontact injury
7	7	Injured, unknown source

**Source:** Zone Center determined--inputs include vehicle inspection, interviewee, and medical records.

**Remarks:**

Injury source is defined as the vehicle component or object that directly caused the injury (direct injury) or initiated the injury mechanism (indirect injury).

**Direct contact injury**

An injury to a particular body region caused by the traumatic contact of that body region with a vehicle component or other object. The vehicle component or other object is coded as the injury source for that injury. Brain injuries, anatomic or non-anatomic, and skull injuries may be caused by the face or head striking a component or object. For these cases, consider the brain or skull injury as a direct injury.

If an object on the occupant (e.g. eyeglasses, pen, pencil, etc.) produces an injury due to contact, consider the object a medium through which force is transmitted rather than the injury source itself. Determine and code the mechanism that contacted the object on the occupant.

Example: Driver’s face strikes steering wheel rim causing eyeglasses to lacerate eyebrow, code injury source as steering wheel rim.

**Indirect contact injury**

An injury to a particular body region caused by a blow or a traumatic contact in some other body region (e.g. head/neck). In the case of the lower or upper extremities, an injury to a particular body member caused by a blow or traumatic contact to a different body member within the same body region (e.g. knee/acetabulum). The injury source for an indirect injury would be the vehicle component contacted by the other body region or member.

Direct/Indirect Injury (cont'd)

Page 2 of 2

**Noncontact injury**

Use when the Source equals **Fire in vehicle, Flying glass, Other noncontact injury source, or Air bag exhaust gases.**

**<Injury, unknown source>**

Automatically system coded when the Injury Source is coded **Injury, unknown source.**

**INJURY RANK**

**Screen Name:** Rank

**SAS Data Set:** *OI*

**SAS Variable:** *RANK*

**Oracle Name:** *INJURY.RANK*

**Element Attributes:**

1

**Source:** Zone center determined

**Remarks:**

The injury with the highest AIS (1-6) is assigned the rank of 1. If there are two or more injuries that meet the criteria of the highest AIS, the injury rank should be based on the source of injury information and confidence of all data.

The injury with the rank of 1 is not necessarily the cause of death.

**MEDICAL RECORD TYPE**

**Screen Name:** Medical Record Type

**SAS Data Set:** *OI*

**SAS Variable:** *SOUDAT*

**Oracle Name:** *INJURY.PICKSOURCE*

**Element Attributes:**

Enter the source of the injury information

Oracle	SAS	
16	16	Internal Autopsy
17	17	External Autopsy
2	2	Post ER Medical Record
8	3	Emergency Room Records
9	4	Private physician
10	5	Lay Coroner
11	6	EMS Record
12	7	Interviewee
13	9	Police report
14	8	Other (specify)

**Source:** Zone center determined

**Remarks:**

Enter the source of the injury information

**Autopsy Internal**

Internal examination of a deceased individual by a licensed or official medical examiner. The examination should be a systematic review all major body regions and organs. Overall anatomical structure and condition should be detailed in conjunction with injury detail (location and measurement) and evidence of possible pre- morbid conditions. An accurate cause of death should be documented.

**Autopsy External only**

External examination of a deceased individual by a licensed or official medical examiner. The examination will consist of a visual record of the individual from general body build and features to details of visible external injury (lacerations, contusions, open fractures). A cause of death will be determined from the examiners external findings. A Death Certificate signed by a medical professional would be included in this attribute.

**Post-ER Medical Record**

Medical chart documentation for an individual admitted to a hospital after initial evaluation in the Emergency Room (ER) or Trauma Resuscitation Unit (TRU). Documentation may be from physicians, nurses, therapists or other health care providers who provide services for the individual during their stay in the hospital. This documentation will cover the period of time from transfer from the ER/TRU till discharge. **Emergency Room Records** - Medical chart documentation for an individual during their stay in the Emergency Room. Documentation may be from physicians, nurses, therapists or other health care providers. Documentation should include an H&P and a disposition plan.

**Private Physician**

Documentation from a physician encounter in a private office or other non-hospital, clinic, or out-patient facility.

**Lay Coroner**

Documentation from an individual appointed by local government to assign cause of death in fatal injury cases in their jurisdiction. These individuals are usually not medical doctors and the injury/cause of death is typically derived from an external exam of the expired individual. This includes death certificates signed by someone other than a medical professional.

**EMS record**

A report from the transporting emergency team detailing an individual's health status at the crash scene and during transport to a health care facility. The report may document visible injury (lacerations) and possible injury (deformed ankle). Vital signs are generally documented as well. Details related to extrication and restraint status might be included in this record.

**Interviewee**

Documented information from an interview with the case occupant or an individual with sufficient knowledge of the occupant's injuries/condition.

**Police Report**

Official document from the reporting officer recording different aspects and details of the crash.

**Other (specify)**

Documentation of medical or injury status not previously mentioned. Specify type of document.

Date	Time	Pulse	Systolic	Diastolic	Respiratory Rate	Source
------	------	-------	----------	-----------	------------------	--------

**VITAL SIGNS** data is rolled up from the EMS Form and medically reported vitals.

Only Zone Centers can edit medically reported vitals.

The date and time is recorded for each set of coded vital signs. Medically reported vital signs are coded a maximum of four times, taken at six hour intervals. During the first 24 hours of arrival at the medical facility, this period is measured from arrival at the emergency room and could include time spent in the emergency room and any hospital admission. If the date/time information is vague, the coder should use their judgment and code the first, second, third and last readings that appear on any record during this time.

After the 24 hours, the first vital sign data recorded for each day should be the vital signs recorded for the individual for that date. If no time or date appears on the medical record or if it is difficult to determine the exact date or time of any recorded vital sign, then code the vital sign but leave the date/time as "unknown".

**Note:** The system will only save one "unknown" time vitals were taken, regardless of the data source.

**OCCUPANT FORM**

**INJURY CODES/INJURIES/MANNEQUINS**

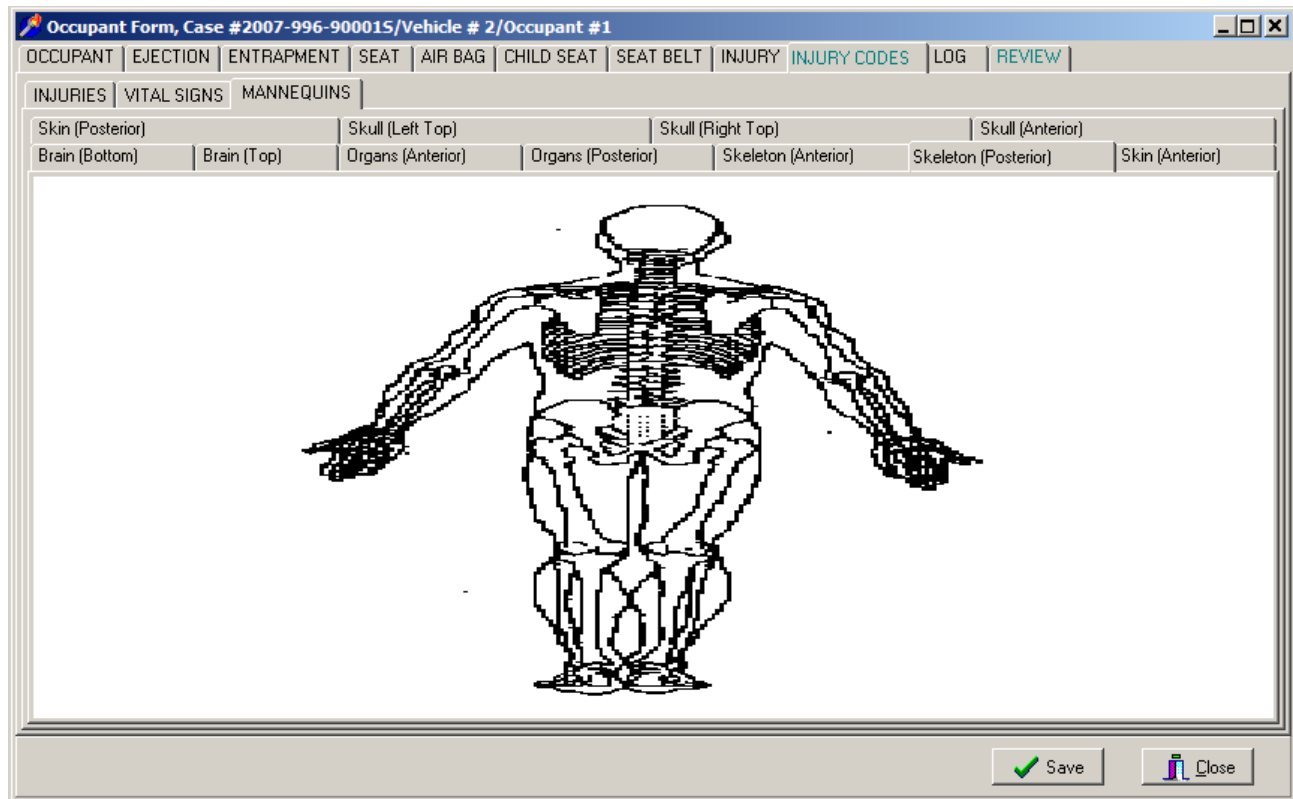

Only Zone Centers can insert/edit this data using the NASSINJURY program.

Occupant Form, Case #2007-996-900015/Vehicle # 2/Occupant #1

OCCUPANT | EJECTION | ENTRAPMENT | SEAT | AIR BAG | CHILD SEAT | SEAT BELT | INJURY | INJURY CODES | LOG | REVIEW

INTERVIEW | MEDICAL

Interviewer

Interviewee

Last Interview Attempt

- Manner

- Result

Interview Date

Save Close

**Note:** Information must be coded by the researcher. This data does not roll up from the Contact Log.



**INTERVIEWER**

**Screen Name:** Interviewer

***SAS Data Set:***

***SAS Variable:***

***Oracle Name:***

**Element Attributes:**

PSU Specific

**Source:** NASS Personnel Roster

**Remarks:**

Select the name of the Researcher completing the interview.

**INTERVIEWEE**

**Screen Name:** Interviewee

**SAS Data Set:**

**SAS Variable:**

**Oracle Name:**

**Element Attributes:**

- No Interview
- Same Person
- Surrogate, Other Occupant
- Surrogate, Relative or friend
- Surrogate, Multiple interviews from above categories (specify)

**Source:**

**Remarks:**

**No Interview**

**Same Person**

**Surrogate, Other Occupant**

**Surrogate, Relative or friend**

**Surrogate, Multiple interviews from above categories (specify)**

**MANNER**

Page 1 of 2

**Screen Name:** Manner

**SAS Data Set:**

**SAS Variable:**

**Oracle Name:**

**Element Attributes:**

No attempt  
Telephone  
In-person  
Questionnaire  
Unknown

**Source:**

**Remarks:**

**INTERVIEW RESULTS**

**Screen Name:** Result

**SAS Data Set:**

**SAS Variable:**

**Oracle Name:**

**Element Attributes:**

Oracle	SAS
1	Unable to contact or locate
2	Hit and Run
3	Fatal-surrogate not available
4	In intensive care-surrogate not available
6	Refused interview
7	Insurance company refusal
8	Attorney refusal or litigation
9	No return of questionnaire
10	Other (specify)
11	Partial interview
12	Complete interview
-8887	Not applicable

**Source:** System Assigned – primary, Researcher - secondary.

**Remarks:**

Select the last response from the appropriate driver or occupant interview section of the Interview Contact Log.

**Unable to contact or locate**

is used only when an appropriate response cannot be selected from the other attributes.

**Hit and Run**

is used when the occupant’s vehicle left the scene of the crash and no data are available about to the identity of the occupant(s).

**Fatal - surrogate not available**

is used when this occupant was fatally injured in the crash and no surrogates exist to obtain a partial interview.

Interview Results (cont'd)

Page 2 of 2

**In intensive care - surrogate not available**

is used when this occupant was admitted into intensive care as a result of this crash and no surrogates exist to obtain a partial interview before file close-out.

**Refused interview**

is used when the owner of the vehicle has been contacted and refuses to allow an interview.

**Insurance company refusal**

is used when the insurance company responsible for the vehicle is contacted and refuses to authorize an interview of the occupant.

**Attorney refusal or litigation**

is used when an interview is denied by an attorney, generally as a result of litigation.

**No return of questionnaire**

is used when the only contact to the occupant is via a questionnaire, and the questionnaire is not returned before file close-out.

**Other (specify)**

is used when no interview was obtained and the above attributes do not adequately capture the reason an interview was not obtained.

**Partial interview**

is used when an interview is obtained but all required questions (listed under the "Complete interview" definition) have not been answered.

**Complete interview**

is used when all required data with respect to crash sequence, vehicle information and injuries are obtained from either the driver or another occupant of the same vehicle.

**Not Applicable**

is used when an interview is not required for this occupant.

**INTERVIEW COMPLETION DATE**

**Screen Name:** Completed

**SAS Data Set:** N/A

**SAS Variable:** N/A

**Oracle Name:**  
*CASESTRUCTUREOCCUPANTS.INTERVIEWCOMPLETEDDATE*

**Element Attributes:**

Month: 01-12  
Day: 01 through 31  
Year: As appropriate

**Source:** Researcher determined

**Remarks:**

When the researcher completes the interview the date of completion is entered here.

Occupant Form, Case #2007-996-900015/Vehicle # 2/Occupant #1

OCCUPANT | EJECTION | ENTRAPMENT | SEAT | AIR BAG | CHILD SEAT | SEAT BELT | INJURY | INJURY CODES | LOG | REVIEW

INTERVIEW | MEDICAL

Injured?

Medical Facility

Medical Facility

Save Close

**Note:** Medical Facility must be entered using the Edit/Insert. Enter all the (primary care) facilities a person went to, related to this crash.

DETAIL

Occupant Form, Case #2007-996-900015/Vehicle # 2/Occupant #1

OCCUPANT | EJECTION | ENTRAPMENT | SEAT | AIR BAG | CHILD SEAT | SEAT BELT | INJURY | INJURY CODES | LOG | REVIEW

PSU REVIEW | ZONE REVIEW

LIST | DETAIL

Form  Tab  Veh#  Occ #

Original  Suggested

Comment

Save Close



DETAIL

Occupant Form, Case #2007-996-900015/Vehicle # 2/Occupant #1

OCCUPANT | EJECTION | ENTRAPMENT | SEAT | AIR BAG | CHILD SEAT | SEAT BELT | INJURY | INJURY CODES | LOG | REVIEW

PSU REVIEW | ZONE REVIEW

LIST | DETAIL

Form  Tab  Veh #  Occ #

Original  Final

Reason  Change

Comment

**EMERGENCY MEDICAL SERVICE (EMS) OVERVIEW**

Emergency Medical Service (EMS) personnel are integral to the survivability of the people involved in crashes. The following variables attempt to collect some basic information on their involvement with crashes.

Information is required for the first EMS unit that responded to the scene of the crash and administered care or transported any occupants. Correspondingly any occupant who receives care or is transported must have information added.

ANY TIME THERE IS INFORMATION THAT AN EMERGENCY UNIT RESPONDED TO THE SCENE OF THE CRASH AN EMS RECORD SHOULD BE REQUESTED FOR EACH OCCUPANT WITH A PAR REPORTED INJURY.

Any time an EMS unit responds to the scene of a crash, all crash involved persons are deemed to receive care if a run sheet is filled out for them.

Do not collect EMS information for those occupants who are declared dead at the scene of the crash. These occupants will have **Treatment** coded as **No Treatment** and **Mortality** coded as **Fatal** or **Fatal Ruled Disease**.

VEHICLES

Emergency Medical Services (EMS)

VEHICLES | CARE | VITAL SIGNS

Agency Type	Type	Mode	Notified	Arrived	Departed	Arvd Medical

Crash Date: 1/14/2007 at

Save Close

**[EMS UNIT NUMBER]**

**Screen Name:** N/A

**SAS Data Set:** *EMS*

**SAS Variable:** *EMSNO (EMS data set);*  
*EMSNO1, EMSNO2, EMSNO3, EMSNO4 (OA data set)*

**Oracle Name:** *DERIVED*

**Element Attributes:**  
System assigned

**Source:** Derived from entered data by the data entry system.

**Remarks:**

The number of the EMS unit. This is derived by the data entry system.

**AGENCY TYPE**

**Screen Name:** Responding Agency

**SAS Data Set:** *EMS*

**SAS Variable:** *EMSTYPE*

**Oracle Name:** *EMSRESPONSE.EMSTYPE*

**Element Attributes:**

Oracle	SAS	
1	1	Fire Department
2	2	Rescue Squad
3	3	Police Department
4	4	Trauma Unit
5	5	Disaster Unit
6	6	Ambulance Service Unit
7	7	Hospital
8	8	Mortuaries/Funeral Home
98	98	Other, Specify
99	99	Unknown

**Source:** EMS records, Emergency room records, PAR, interviewee

**Remarks:**

Indicate the responding agency of the EMS vehicle. The classification of that vehicle will be entered under **EMS Form/Vehicles/Responding Emergency Vehicle Type**.

**Fire Department**

Any vehicle that belongs to a fire department will be classified here.

**Rescue Squad**

Make this selection only if it is not associated with a fire department, police department, or hospital.

**Police Department**

Any vehicle that belongs to a police department will be classified here.

**Trauma Unit**

All trauma units that cannot be classified as a fire department, police department or hospital will fall here.

**Disaster Unit**

This will primarily occur during some national disaster.

Responding Agency (cont'd)

Page 2 of 2

**Remarks:****Ambulance Service Unit**

An ambulance not otherwise connected with any other type will be entered here.

**Hospital**

Any unit that belongs to a hospital will be classified here.

**Mortuaries/Funeral Home**

In some very rural areas, the only unit available may be from a mortuary or funeral home. In those cases, make this selection.

**Other, Specify**

Use this attribute if the agency type can not be selected from the above listed attributes. An example would be a military ambulance.

**Unknown**

If a determination could not be made of the agency type from the available documentation or interviews, select this attribute.

**RESPONDING EMERGENCY VEHICLE TYPE**

**Screen Name:** Type of Vehicle

**SAS Data Set:** *EMS*

**SAS Variable:** *EMSVTYPE*

**Oracle Name:** *EMSRESPONSE.VEHICLETYPEID*

**Element Attributes:**

Oracle	SAS	
1	1	Ambulance
2	2	Fire Truck/Apparatus
5	8	Other
9	9	Unknown

**Source:** EMS records, Emergency room records, PAR

**Remarks:**

This variable captures information irrespective of the operating authority or organization that is sponsoring/running the vehicle. Thus a fire department or hospital that uses an ambulance for EMS will be coded as **Ambulance**.

**Ambulance**

An ambulance is a vehicle that is specifically designed to provide care and transport people. An ambulance run by a Fire department should be included here. Helicopters/planes should be included here.

**Fire Truck/Apparatus**

Includes any vehicle other than an ambulance run by the Fire department.

**Other**

Any other unit not covered above will be entered here. This is very unlikely to occur.

**Unknown**

If a determination could not be made of the emergency vehicle type from the available documentation or interviews, select this attribute.

**TRANSPORTATION MODE**

**Screen Name:** Mode

**SAS Data Set:** *EMS*

**SAS Variable:** *EMSMODE*

**Oracle Name:** *EMSRESPONSE.EMSMODE*

**Element Attributes:**

Oracle	SAS	
1	1	Land
3	2	Air

**Source:** EMS records, Emergency room records, PAR, interviewee

**Remarks:**

Indicate what type of EMS vehicle came to the crash scene or transfer vehicle. Assume it is a road vehicle, unless contrary information is present.

**Land**

**Air**



**NOTIFICATION TIME**

**Screen Name:** Notified

**SAS Data Set:** *EMS*

**SAS Variable:** *NOTTIME*

**Oracle Name:** *EMSRESPONSE.NOTIFICATIONTIME*

**Element Attributes:**

- Enter the EMS notification time in military time format.
- 8888 Not Applicable
- 9999 Unknown

**Source:** EMS records, Emergency room records, PAR, interviewee

**Remarks:**

This variable indicates the notification **time** that **this vehicle was notified** to come to the crash scene. The notification can be made by any source (police, involved persons, witnesses, etc.).

Indicate the time that this unit was notified to come to the crash scene for any occupant in the crash.

**ARRIVAL TIME**

**Screen Name:** Arrived

**SAS Data Set:** *EMS*

**SAS Variable:** *ARRTIME*

**Oracle Name:** *EMSRESPONSE.ARRIVALTIME*

**Element Attributes:**

Enter the EMS arrival on scene time in military time format.  
8888 Not Applicable  
9999 Unknown

**Source:** EMS records, Emergency room records, PAR, interviewee

**Remarks:**

This variable indicates the **time** that **this vehicle arrived at** the crash scene. The notification can be made by any source (police, involved persons, witnesses, etc.).

Indicate the time that the EMS unit stops physical motion at the scene. If an individual EMT arrives at the scene by private vehicle, that time is NOT the recorded value for this variable.

**TIME OF DEPARTURE FROM THE SCENE**

**Screen Name:** Departed

**SAS Data Set:** *EMS*

**SAS Variable:** *DEPTIME*

**Oracle Name:** *EMSRESPONSE.DEPARTURETIME*

**Element Attributes:**

- Enter the EMS departure time in military time format.
- 8886 Transport refused
- 8888 Not Applicable
- 9999 Unknown

**Source:** EMS records, Emergency room records, PAR, interviewee.

**Remarks:**

Enter the time that the unit departed for the treatment unit or transfer vehicle.

**Transport refused**

Use this attribute when a person refuses transport to a treatment facility, regardless of treatment level at the crash site.

**Not applicable**

Units which just provide treatment at the crash site and do not transport occupants are entered as **Not applicable**.

Units which do not respond to the crash site, but do receive patient(s) at a transfer point in order to transfer them to a treatment facility, are entered as **Not Applicable**.

**Unknown**

Use this attribute for instances where the time of departure cannot be determined from any source.

**ARRIVED AT MEDICAL FACILITY**

**Screen Name:** Arvd Medical

**SAS Data Set:** *EMS*

**SAS Variable:** *MEDTIME*

**Oracle Name:** *EMSRESPONSE.MEDARRIVALTIME*

**Element Attributes:**

Enter the EMS arrival time in military time format.  
8888 Not Applicable  
9999 Unknown

**Source:** EMS records, Emergency room records, PAR, interviewee.

**Remarks:**

Enter the time that the unit with the occupant arrived at the treatment facility.

This may be the unit that responded to the crash site or a unit which received the occupant at a point between the crash site and the treatment facility.

**Not applicable**

Units which just provide treatment at the crash site and do not transport occupants are entered as **Not applicable** .

Units which leave the scene and only transport occupant(s) to a transfer vehicle are entered as **Not applicable**.

**Unknown**

Use this attribute for instances where the time of arrival cannot be determined from any source.

EMS CARE

Emergency Medical Services (EMS)

VEHICLES | CARE | VITAL SIGNS

EMS Vehicle

Vehicle/Occupant	Care	Note

Crash Date

**Note:** Select edit/insert from the main menu. A new screen appears (see below) from which you select Vehicle #, Occupant # and Care.

EMSCare

Fire Department

Vehicle

Occupant

Care

Note

**VEHICLE #**

**Screen Name:** Vehicle #

**SAS Data Set:** N/A

**SAS Variable:** N/A

**Oracle Name:** ***VEHICLE.VEHICLENUMBER***

**Element Attributes:**

Enter the vehicle # for the occupant being reported on

**Source:** EMS records, Emergency room records, PAR

**Remarks:**

**OCCUPANT #**

**Screen Name:** Occupant #

**SAS Data Set:** N/A

**SAS Variable:** N/A

**Oracle Name:** ***OCCUPANT.OCCUPANTNUMBER***

**Element Attributes:**

Enter the occupant # for the occupant being reported on

**Source:** EMS records, Emergency room records, PAR

**Remarks:**

## TYPE OF EMS CARE ADMINISTERED

Page 1 of 2

Screen Name: Type of Care

SAS Data Set: OA

SAS Variable: CARETYP1, CARETYP2, CARETYP3, CARETYP4

Oracle Name: EMS\_X\_CARE.CARETYPE

## Element Attributes:

Oracle	SAS	
0	0	No Care Administered
1	1	Basic Life Support
2	2	Advanced Life Support
7	7	Care administered, type unknown
9	9	Unknown if care administered

Source: EMS records, Emergency room records, PAR

## Remarks:

For this variable, the taking of a pulse, blood pressure, or just the general assessment of a person's health is considered care. Therefore all crash involved persons receive care from any EMS unit at the scene. This minimal level of care is considered **Basic Life Support**. However, not all persons are transported, and some persons refuse transport.

Indicate what type of EMS care was administered:

**No Care Administered**

Select this when this occupant was transported but did not receive any treatment **including monitoring of vital signs.**

**Basic Life Support**

Includes non-invasive care such as stabilizing the patient, stop bleeding, and opening of air way, vitals, and basic CPR.

**Advanced Life Support**

In addition to the care listed under **Basic Life Support**, this includes invasive procedures (IV Fluids, intubation), burn care, emergency cardiac care/CPR (use of defibrillator).

**Care Administered, Type Unknown**

Use this attribute in instances where treatment was definitely administered, e.g. severity of injuries but NO details are available.



Type of EMS Care Administered (cont'd)

Page 2 of 2

**Unknown if Care Administered**

Use if there is evidence that EMS responded to the crash site but no further information is available about this occupant and the police crash report assigns this occupant an injury code of K, A, B or C.

VITAL SIGNS

The screenshot shows a software window titled "Emergency Medical Services (EMS)". It has three tabs: "VEHICLES", "CARE", and "VITAL SIGNS", with "VITAL SIGNS" being the active tab. Below the tabs, there are input fields for "EMS Vehicle" (containing "Fire Department"), "Vehicle #" (containing "1"), and "Occupant #" (containing "1"). A table with the following columns is visible: "Date", "Time", "Pulse", "Systolic", "Diastolic", and "Respiratory Rate". The table is currently empty. At the bottom of the window, there is a "Crash Date" field containing "1/14/2007 at", and two buttons: "Save" (with a green checkmark icon) and "Close" (with a red X icon).

If no vital signs, do not enter "U" across the grid, if one variable is known enter that data, the other variables would be coded as "U". Enter initial and final vitals taken (regardless of vehicle type for the same individual (ex. Land or air vehicle.)

**[VITAL SIGN NUMBER]**

**Screen Name:** N/A

**SAS Data Set:** *VSIGN*

**SAS Variable:** *VSIGNNO*

**Oracle Name:** *DERIVED*

**Element Attributes:**

Sequentially numbered by system

**Source:** EMS and other medical records

**Remarks:**

**TIME OF READING****Screen Name:** Time**SAS Data Set:** *VSIGN***SAS Variable:** *VTIME***Oracle Name:** *PHYSIOLOGIC.SIGNTIME***Element Attributes:**

9999 Enter time, in military time format, for the vital signs reading that was taken  
Unknown

**Source:** EMS records**Range:** 1-2400, 9999**Remarks:**

Enter the time that the vital signs readings were taken.

**Unknown**

Enter in the first space of the variable, the program will fill in the remainder of the attribute.

**Note:** Only one vital sign with an unknown time can be entered into the electronic system.

**PULSE**

**Screen Name:** Pulse

**SAS Data Set:** *VSIGN*

**SAS Variable:** *PULSE*

**Oracle Name:** *PHYSIOLOGIC.PULSE*

**Element Attributes:**

Oracle	SAS	
0-300	0-300	Enter pulse of patient
-8888	P	Palpable
-9999	U	Unknown

**Source:** EMS records

**Remarks:**

Enter the recorded pulse count of the patient. Range is 0-300.

**P Palpable**

Enter P (the rest of the word is automatically filled in) when palpable is used in the EMS record.

**U Unknown**

Enter U (the rest of the word is automatically filled in) when there is no recorded value for pulse.

**[ELAPSED TIME SINCE CRASH OF VITAL TIME READING]**

**Screen Name:**

*SAS Data Set:*        *VSIGN*

*SAS Variable:*        *VTIME*

*Oracle Name:*        *PHYSIOLOGIC.SIGNTIME*

**Element Attributes:**

                          Number of minutes since crash when vital sign reading is taken  
          9999           Unknown

**Source:**   EMS records

**Range:**

**Remarks:**

Information is computed by the system relating to date and time of crash as compared to date and time of vital sign reading.

**SYSTOLIC BLOOD PRESSURE**

**Screen Name:** Systolic Systolic Blood Pressure

**SAS Data Set:** *VSIGN*

**SAS Variable:** *SYST*

**Oracle Name:** *PHYSIOLOGIC.SYSTOLIC*

**Element Attributes:**

Oracle	SAS	
0-300	0-300	Enter systolic value for patient
-8888	P	Palpable
-9999	U	Unknown

**Source:** EMS records

**Remarks:**

Enter the recorded systolic pressure value of the patient. Range is 0-300.

**P Palpable**

Enter P (the rest of the word is automatically filled in) when palpable is used in the EMS record.

**U Unknown**

Enter U (the rest of the word is automatically filled in) when there is no recorded value for systolic blood pressure.

**DIASTOLIC BLOOD PRESSURE**

**Screen Name:** Diastolic

**SAS Data Set:** *VSIGN*

**SAS Variable:** *DIAST*

**Oracle Name:** *PHYSIOLOGIC.DIASTOLIC*

**Element Attributes:**

Oracle	SAS	
0-300	0-300	Enter diastolic value for patient
-8888	P	Palpable
-9999	U	Unknown

**Source:** EMS records

**Remarks:**

Enter the recorded diastolic pressure value of the patient. Range is 0-300.

**P Palpable**

Enter P (the rest of the word is automatically filled in) when palpable is used in the EMS record.

**U Unknown**

Enter U (the rest of the word is automatically filled in) when there is no recorded value for diastolic blood pressure.



**RESPIRATORY RATE**

**Screen Name:** Respiratory Rate

**SAS Data Set:** *VSIGN*

**SAS Variable:** *REPRATE*

**Oracle Name:** *PHYSIOLOGIC.RESPRATE*

**Element Attributes:**

Oracle	SAS	
		Enter the respiratory rate of the patient
-8888	A	Agonal
-9999	U	Unknown

**Source:** EMS records

**Range:** 0-98, 997, 999

**Remarks:**

Enter the recorded diastolic pressure value of the patient.

**A Agonal**

Enter A (the rest of the word is automatically filled in) when agonal is used in the EMS record.

**U Unknown**

Enter U (the rest of the word is automatically filled in) when there is no recorded value for respiratory rate.

**APPENDIX A**  
**MAKE MODEL**  
**Year 2011**

Model	Includes	Start	End	SAS Model	ModelID
<b>ACURA / 54</b>					
INTEGRA	RS, LS, GS (use 9 stiffness for front impacts, size value for side or rear impacts)	1986	1998	031	435
LEGEND	(use 9 stiffness for front impacts, size value for side or rear impacts)	1986	1995	032	19571
RL	(use 9 stiffness for front impacts, size value for side or rear impacts)	1996	2000		437
NSX	NTX-T	1991	2000	033	440
VIGOR	(use 9 stiffness for front impacts, size value for side or rear impacts)	1992	1994	034	476
CL	Coupe (use 9 stiffness for front impacts, size value for side or rear impacts)	1996	1998	035	6849
TL	(Stiffness 9 applies only to frontal impacts. Use size value for rear or side impacts.)	1996	1998		19947
RSX		2002		038	45074
TSX		2004		039	158101
ZDX	Body Type = 05/ 5-door/4-door hatchback	2010		040	274505
SLX	(Applies to front and rear impacts. Use side value for side impacts.)	1996	1998	401	6851
RDX		2007		402	232936
MDX		2001		421	39814

**ALFA ROMEO / 31**

SPIDER	All roadsters, Veloce, 1750/2000 roadsters	1933	1994	031	785
SPORTS SEDAN	All 4 door sedans; Giulia, Super, Berlina, Alfetta, Milano, 1750/2000 sedans	1933	1989	032	6776
SPRINT SPECIAL	All 2-door coupes; Alfetta GT, 1750/2000 sedans	1933	1980	033	786
GTV-6		1981	1986	034	6779
164		1990	1995	035	6781

**AM GENERAL / 3**

DISPATCHER - Post Office (Jeep)	Post Office (Jeep)	1965	1994	401	6195
HUMMER H3		2006		402	233078
HUMMER H1/H2		1993		421	6197
DISPATCHER - DJ series Post Office Van	DJ series Post Office Van	1965	1991	466	6199
MEDIUM/HEAVY TRUCK	Military off-road	1965	1994	884	6201
BUS - REAR ENGINE/FLAT FRONT	Transit	1965	1994	983	152

**AMC/AMERICAN MOTORS / 1**

Model	Includes	Start	End	SAS Model	ModelID
<b>AMC/AMERICAN MOTORS / 1</b>					
RAMBLER/AMERICAN	Rogue, Scambler, 220, 440	1954	1969	001	5821
REBEL/MATADOR	Matador: WB=115"		1978	002	6148
	Barcelona, Classic, Brougham, 550, 660, 770, Marlin: WB=114"		1998		
	Matador: WB=114"	1958	1974		
	Barcelona, Classic, Brougham, 550, 660, 770, Marlin: WB=115"	1964	1978		
AMBASSADOR	Brougham, DPL, SST, DL, Limited, 880. 990		1998	003	6153
PACER	Limited, DL	1975	1980	004	131
AMX	2-seater only	1968	1970	005	6156
JAVELIN	SST		1998	006	6158
	AMX	1971	1974		
HORNET/CONCORD	Sportabout, limited, DL, SC-360, SST		1998	007	6161
	AMX	1975	1978		
SPIRIT/GREMLIN	Limited, DL. Custom., X		1998	008	132
	AMX	1979	1998		
	GT	1983	1998		
EAGLE	Concord based	1980	1987	009	129
EAGLE SX-4	Spirit/Gremilin based	1981	1984	010	130

**ASTON MARTIN / 69**

LAGONDA		1968	2000	031	9595
VANTAGE		1968	2000		9597
SALOON		1968	2000		9601
VOLANTE		1968	2000		9599

**AUDI / 32**

SUPER 90		1970	1972	031	6795
100/A6	S, LS, GL	1970	1977	032	797
	Quattro	1989	1994		
	A6	1995	1998		
FOX		1974	1979	033	6797

Model	Includes	Start	End	SAS Model	ModelID
<b>AUDI / 32 (con't)</b>					
4000	Quattro, Coupe GT, CS, S	1980	1988	034	803
5000	Quattro, CS, S, Turbo	1978	1988	035	16507
80/90	Quattro-80	1988	1992	036	809
	Quattro-90	1988	1995		
200	Quattro	1989	1992	037	802
V8 QUATTRO		1990	1994	038	817
COUPE QUATTRO		1990	1993	039	814
S4/S6	S4	1993	1994	040	816
	S6	1995	1998		
CABRIOLET		1994	1998	041	6799
A4		1996	1998	042	6801
A3		1996	1998	043	6803
A8		1996	1998	044	6805
TT	(Stiffness 9 applies only to frontal impacts. Use size value for rear or side impacts.)	2000	2000	045	20200
S8		2001		046	39816
ALLROAD		2001		047	44656
A5		2008		049	232940
R8		2008		050	232942
Q7		2007		401	210233
Q5		2008		402	232948
OTHER LIGHT TRUCK		2007		498	210235
UNKNOWN LIGHT TRUCK		2007		499	210237

**AUSTIN / AUSTIN HEALEY / 33**

MARINA	GT		1998	031	6807
AMERICA			1998	032	6809
HEALEY SPRITE			1998	033	6811
HEALY 3000	Healy 100		1998	034	6813
MINI			1998	035	6815

**BMW / 34**

Model	Includes	Start	End	SAS Model	ModelID
<b>BMW / 34 (con't)</b>					
1600, 2002	Tii, 1800i, 200CS		1976	031	6822
COUPE	2800CS, 3.0CS	1969	1976	032	6824
BAVARIA SEDAN	2500, 2800	1969	1974	033	6826
3 SERIES	318i, 318ti, 320i, 325e, 325es, 325i, 328, M3	1977	1998	034	824
5 SERIES	524i, 258i, 530i, 533i, 535i, TD	1975	1998	035	826
	525i (wagon), M5, 540iA, 540i	1993	1998		
6 SERIES	630, 633, 635, csi, M6	1977	1998	036	829
7 SERIES	733i, 435i, L7, 740i, 750iL	1978	1998	037	830
8 SERIES	850, 840ci	1990	1997	038	6828
Z3	M coupe (Brickland)	1996	1998	039	6830
Z8		2000		040	45076
V5		2007		041	232954
Z4		2003		042	146512
1 SERIES	128i, 135i	2008		043	269758
X6		2008		044	269760
X5	4WD	2000		401	37074
X3		2004		402	158103

**BROCKWAY / 80**

MEDIUM/HEAVY TRUCK BASED MOTORHOME			1998	850	9676
MEDIUM/HEAVY - CBE			1998	881	9678
MEDIUM/HEAVE - COE/LOW ENTRY			1998	882	9680
MEDIUM/HEAVY - COE HIGH ENTRY			1998	883	9682
MEDIUM/HEAVY - UNKNOWN ENGINE LOCATION			1998	884	9685
MEDIUM/HEAVY - COE/ENTRY POSITION UNKNOWN			1998	890	9687
MEDIUM/HEAVY - OTHER			1998	898	9689

**BUICK / 18**

SPECIAL/SKYLARK (thru 1972)	GS, GS-350, GS-400, GS-455, GS California, Sport wagon, Custom		1972	001	6512
LESABRE/CENTURION/WILDCAT	Wagon, Luxus, Invicta, Custom, Limited		1976	002	1140

Model	Includes	Start	End	SAS Model	ModelID
<b>BUICK / 18 (con't)</b>					
LESABRE/CENTURION/WILDCAT	Wagon, Luxus, Invicta, Custom, Limited	1977	1985	002	1140
	T-Type (use 9 stiffness for front impacts, size value for side or rear impacts)	1986	1998		
ELECTRA/ELECTRA 225/PARK AVENUE (91-ON)	Limited, Park Avenue, Ultra		1976	003	1145
	Limited, Park Avenue, Ultra	1977	1984		
	Limited, Park Avenue, Ultra (use 9 stiffness for front impacts, size value for side or rear impacts)	1985	1998		
ROADMASTER	Estate Wagon, Limited	1991	1996	004	1163
RIVIERA	S-Type, T-Type	1963	1965	005	1161
	S-Type, T-Type	1966	1976		
	S-Type, T-Type	1977	1985		
	S-Type, T-Type (use 9 stiffness for front impacts, size value for side or rear impacts)	1986	1993		
	S-Type, T-Type (use 9 stiffness for front impacts, size value for side or rear impacts)	1994	1998		
CENTURY	Luxus, Custom		1977	007	1135
	Luxus, Regal	1972	1977		
	Custom	1978	1981		
	Custom, FWD (use 9 stiffness for front impacts, size value for side or rear impacts)	1982	1998		
APOLLO/SKYLARK (73-76)	Skylark (75), S/R	1973	1976	008	27310
REGAL	Turbo, Luxus, Gran National, GNX, T-Type	1978	1988	010	1153
SKYHAWK	S-Type, Roadhawk, T-Type, GT	1975	1981	012	1166
	(use 9 stiffness for front impacts, size value for side or rear impacts)	1982	1998		
SKYLARK (76-85)	S/R, S, Limited, Sport, T-Type	1976	1979	015	1168
	S/R, S, Limited, Sport, T-Type (use 9 stiffness for front impacts, size value for side or rear impacts)	1980	1985		
SOMERSET(85-87)/SKYLARK(86-ON)	Somerset, GS Regal, Custom, Limited, T-Type (use 9 stiffness for frontal impacts).	1985	1987	018	1169
	Skylark ('86-on) (Use 9 stiffness for frontal impacts).	1986	1999		
REGAL (FWD)	Limited	1988	1998	020	1154
REATA		1988	1991	021	1152
LACROSSE		2005		022	174884
LUCERNE		2006		023	210239

Model	Includes	Start	End	SAS Model	ModelID
<b>BUICK / 18 (con't)</b>					
ENCLAVE		2008		024	232958
OPEL KADETT			1975	031	6514
OPEL MANTA	1900, Luxus, Rallye, Sports Coupe		1975	032	6516
OPEL GT			1975	033	6518
OPEL ISUZU	Deluxe, Sport	1976	1979	034	6521
RENDEZVOUS		2002		401	40757
RAINIER		2004		402	158105
TERRAZA		2005		441	174886

**CADILLAC / 19**

DEVILLE/FLEETWOOD	Coupe de Ville, Sedan de Ville, Fleetwood Brougham, Fleetwood 60 Special, d'Elegance (use 9 stiffness for front impacts, size value for side or rear i		1976	003	1195
	RWD--Coupe de Ville, Sedan de Ville, Fleetwood Brougham, Fleetwood 60 Special, d'Elegance (use 9 stiffness for front impacts, size value for side or r	1977	1996		
	FWD d'Elegance (use 9 stiffness for front impacts, size value for side or rear impacts)	1985	1998		
	Concourse (use 9 stiffness for front impacts, size value for side or rear impacts)	1994	1998		
LIMOUSINE	Fleetwood 75, Formal, DeVille-Based		1998	004	1183
ELDORADO	Biarritz, El-doro, Touring Coupe		1978	005	1187
	Biarritz, El-doro, Touring Coupe	1979	1985		
	Biarritz, El-doro, Touring Coupe (use 9 stiffness for front impacts, size value for side or rear impacts)	1986	1998		
COMMERCIAL SERIES	Ambulance/Hearse		1998	006	6537
ALLANTE		1987	1998	009	1178
SEVILLE	Elegante	1976	1985	014	1197
	STS (use 9 stiffness for front impacts, size value for side or rear impacts)	1986	1998		
CIMARRON	D'oro (use 9 stiffness for front impacts, size value for side or rear impacts)	1982	1988	016	1180
CATERA	RWD	1997	1998	017	6539
CTS		2003		018	45079
XLR		2004		019	146514
SRX		2004		020	158107
STS		2005		021	174888



Model	Includes	Start	End	SAS Model	ModelID
<b>CADILLAC / 19 (con't)</b>					
DTS		2006		022	210241
ESCALADE ESV		2003		431	146516
ESCALADE EXT		2002		481	146518
<b>CHECKER / 29</b>					
MARATHON			1982	002	9548
TAXI			1982		9564
SUPERBA			1982		9562
AEROBUS			1982		9566
UNKNOWN AUTOMOBILE			1982		9570
OTHER AUTOMOBILE			1982		9569
<b>CHEVROLET / 20</b>					
CHEVELLE/MALIBU (thru 83)	Classic, Concours, S-3, Laguna, Nomad, 300, Greenbriar, Estate, Deluxe, SS 396/454	1964	1977	001	1024
	Classic, Concours, S-3, Laguna, Nomad, 300, Greenbriar, Estate, Deluxe, SS 396/454	1978	1983		
IMPALA/CAPRICE	Biscayne, Belair, Super sport, Classic Classic Brougham, Townsman		1976	002	1017
	St. Wgn. Biscayne, Belair, Super sport, Classic Classic Brougham, Townsman		1976		
	Brookwood, Kingswood	1977	1998		
CORVETTE	Stingray	1953	1962	004	1001
	Stingray	1963	1998		
CORVAIR	Monza, Corsa, 500, Yenko	1960	1969	006	6574
EL CAMINO	Royal Knight, SS (use 8 stiffness for end impacts, size value for side impacts)	1959	1960	007	6545
	Royal Knight, SS (use 8 stiffness for end impacts, size value for side impacts)	1964	1977		
	Royal Knight, SS (use 8 stiffness for end impacts, size value for side impacts)	1978	1998		
NOVA (-79)	Chevy II, LN, LE, Concours SS-350/396, Rally	1962	1979	008	6576
CAMARO	SS, RS, LT, Berlinetta, IROC-Z, Z28	1967	1998	009	979
MONTE CARLO ('70-'88) (RWD ONLY)	LS, SS, Aerocoupe, Landau	1970	1977	010	1025
	LS, SS, Aerocoupe, Landau	1978	1988		
VEGA	GT, Cosworth	1971	1977	011	6578

Model	Includes	Start	End	SAS Model	ModelID
<b>CHEVROLET / 20 (con't)</b>					
MONZA	Spyder, 2+2, Towne Coupe	1975	1980	012	1030
CHEVETTE	S, Scooter, CS--2 door	1976	1987	013	996
	S, Scooter, CS-4 door	1976	1987		
CITATION	X-11, Citation II (use 9 stiffness for front impacts, size value for side or rear impacts)	1980	1985	015	997
CAVALIER	CS, RS, Z24, LS	1982	1998	016	989
CELEBRITY	CS, Eurosport, VR	1982	1998	017	994
BERETTA/CORSICA	GT (use 9 stiffness for front impacts, size value for side or rear impacts)	1988	1998	019	998
LUMINA	Z-34, Euro (use 9 stiffness for front impacts, size value for side or rear impacts)	1990	1998	020	1019
COBALT		2005		022	174890
HHR		2006		023	210243
TRAVERSE	LS, LT, LTZ	2009		024	268609
SPECTRUM		1985	1998	031	1032
NOVA/GEO PRIZM	CL, NUMMI-built vehicle (use 9 stiffness for front impacts, size value for side or rear impacts)	1985	1998	032	1007
SPRINT/GEO SPRINT		1985	1998	033	1010
GEO METRO	LSi, Xfi	1989	1998	034	1004
GEO STORM	Gsi	1985	1998	035	1012
MONTE CARLO (1995+) (FWD ONLY)	Z34 (use 9 stiffness for front impacts, size value for side or rear impacts)	1995	1998	036	6580
MALIBU (1997+)		1997	2009	037	6582
SSR		2004		038	157958
AVEO		2004		039	158109
S-10 BLAZER, BLAZER	S-10 p/u based (100.5" WB) (use 7 stiffness for end impacts, size value for side impacts)	1983	1994	401	6584
	Blazer (use 7 stiffness for end impacts, size value for side impacts)	1995	1998		
GEO TRACKER	Lsi (use 8 stiffness for end impacts, size value for side impacts)	1989	1998	402	1014
TRAILBLAZER (2002 and later)		2002		403	133074
EQUINOX		2005		404	158113
FULLSIZE BLAZER (K, Tahoe)	K-series, fullsized p/u based (use 8 stiffness for end impacts, size value for rear impacts)	1969	1994	421	6587
	Tahoe (use 8 stiffness for end impacts, size value for side impacts)	1995	1998		

Model	Includes	Start	End	SAS Model	ModelID
<b>CHEVROLET / 20 (con't)</b>					
SUBURBAN	(use 8 stiffness for end impacts, size value for side impacts)		1998	431	6590
ASTRO VAN	Minivan (use 7 stiffness for end impacts, size value for side impacts)	1985	1998	441	6592
LUMINA APV/VENTURE	Venture, (use 7 stiffness for end impacts, size value for side impacts)	1990	1998	442	6594
UPLANDER		2005		444	174892
G-SERIES VAN	Beauville, Chevy Van, Sport Van, G10-G30, Express (use 7 stiffness for end impacts, size value for side impacts)		1998	461	6599
P-SERIES VAN	(use 7 stiffness for end impacts, size value for side impacts)		1998	466	6601
VAN DERIVATIVE	Hi-cube, Parcel Van (use 7 stiffness for end impacts, size value for side impacts)		1998	470	6603
S-10/T-10	4 X 4 (use 8 stiffness for end impacts, size value for side impacts)	1982	1998	471	6605
LUV	Imported pickup (use 7 stiffness for end impacts, size value for side impacts)		1998	472	6607
COLORADO		2004		473	158111
C, K, R, V-SERIES PICKUP	C10-C30, K10-K30, R10-R30, V10-V30, Silverado, C-K 1500, 2500, 3500 (use 8 stiffness for end impacts, size value for side impacts)		1998	481	6609
AVALANCHE		2002		482	44657
MEDIUM/HEAVY CBE	C50/60/65; M60/65; H70/80/90; J70/80/90; Bison 90; all other CBE		1998	881	6611
MEDIUM/HEAVY COE LOW ENTRY	T60/65 - all other COE low entry		1998	882	6613
MEDIUM/HEAVY COE HIGH ENTRY	Titan 90, all other COE high entry		1998	883	6615
MEDIUM/HEAVY; UNKNOWN ENGINE LOCATION	MKIII, 1500		1979	890	6619
BUS	S-60 series		1998	981	1042

**CHRYSLER / 6**

CORDOBA	Crown, 300, LS	1975	1983	009	159
RAMPAGE 2.2 (CAR BASED PICKUP)	GT, Sport	1982	1984	013	6274
RWD ONLY-NEW YORKER/NEWPORT/5TH AVENUE/IMPERIAL	300		1971	014	160
	Custom, Royal, Brougham, Town and Country		1978		
	Custom, Royal, Brougham, Town and Country	1979	1981		
	Custom, Royal, Brougham, Town and Country	1982	1989		
NEW YORKER/E CLASS/IMPERIAL/5TH AVENUE	FWD vehicles, Turbo (use 9 stiffness for front impacts, size value for side or rear impacts)	1983	1993		163

Model	Includes	Start	End	SAS Model	ModelID
<b>CHRYSLER / 6 (con't)</b>					
NEW YORKER/E CLASS/IMPERIAL/5TH AVENUE	Imperial (use 9 stiffness for front impacts, size value for side or rear impacts)	1990	1993	014	163
LASER	Turbo, XE, XT (use 9 stiffness for front impacts, size value for side or rear impacts)	1984	1986	015	164
LEBARON	Medallion, Salon (RWD), Landau, LX	1977	1981	016	165
	FWD except GTS or GTC Sport Coupe (use 9 stiffness for front impacts, size value for side or rear impacts)	1982	1998		
LEBARON GTS/GTC	GTS-Turbo (use 9 stiffness for front impacts, size value for side or rear impacts)	1985	1998	017	166
	GTC-Sport Coupe (use 9 stiffness for front impacts, size value for side or rear impacts)	1987	1998		
TC (MASERATI SPORT)	Turbo Convertible	1988	1991	031	181
CONQUEST	TSI, Turbo	1987	1989	035	158
CONCORDE		1993	1998	041	157
LHS	New Yorker (use 9 stiffness for front impacts, size value for side or rear impacts)	1994	1998	042	171
SEBRING		1995	1998	043	180
CIRRUS	(use 9 stiffness for front impacts, size value for side or rear impacts)	1995	1998	044	156
300/300M/300C		1999	2000	051	20209
PT CRUISER		2001		052	36181
PROWLER		2001	2002	053	146522
PACIFICA		2004		054	146524
CROSSFIRE		2004		055	158115
ASPEN		2007		421	232963
TOWN AND COUNTRY	Minivan (use 7 stiffness for end impacts, size value for side impacts)	1990	1998	441	183
VOYAGER		2000		442	38486

**CONSULIER / 29**

OTHER AUTOMOBILE			1998	398	9589
UNKNOWN AUTOMOBILE			1998		9591

**DAEWOO / 64**

LANOS		1999	2000	031	20213
LEGANZA		1999	2000	033	20217

**DAIHATSU / 60**

Model	Includes	Start	End	SAS Model	ModelID
<b>DAIHATSU / 60 (con't)</b>					
CHARADE		1990	1992	031	458
ROCKY	(use 8 stiffness for end impacts, size value for side impacts)	1990	1992	401	459
<b>DESOTO / 29</b>					
OTHER AUTOMOBILE			1998	398	9568
UNKNOWN AUTOMOBILE			1998		9572
<b>DIAMOND REO/REO / 81</b>					
MEDIUM/HEAVY TRUCK BASED MOTORHOME			1998	850	9655
MEDIUM/HEAVY - CBE			1998	881	9657
MEDIUM/HEAVY - COE/LOW ENTRY			1998	882	9666
MEDIUM/HEAVY - COE/HIGH ENTRY			1998	883	9668
MEDIUM/HEAVY - UNKNOWN ENGINE LOCATION			1998	884	9670
MEDIUM/HEAVY - OTHER			1998	898	9673
<b>DODGE / 7</b>					
DART	Custom, Swinger, Sport, GT, Demon, Special, Special Edition, 170, 270, 340, 360: WB=111"	1962	1976	001	6259
	Custom, Swinger, Sport, GT, Demon, Special, Special Edition, 170, 270, 340, 360: WB=108"	1962	1976		
CORONET/CHARGER/MAGNUM	Charger		1978	002	226
	Brougham, Custom, Superbee, Crestwood, Deluxe, XE, R/t, SE 440, 500, Police		1979		
POLARA/MONACO/ROYAL MONACO	Custom, Special, Crestwood, Brougham, Police Taxi		1976	003	6264
	Custom, Special, Crestwood, Brougham, Police Taxi	1977	1978		
VIPER	RT/10, GTS	1992	1998	004	6268
CHALLENGER (1970-1974)	R/T, T/A, Rallye	1970	1974	005	6270
ASPEN	Custom, Special Edition, Police, R/T, Sport: WB=113"	1976	1980	006	195
	Custom, Special Edition, Police, R/T, Sport: WB=109"	1976	1980		
DIPLOMAT	Medallion, Salon, S	1977	1989	007	215
OMNI/CHARGER	O24, DeTomaso, Miser, GLH, GLHS, Shelby, America, Expo	1978	1990	008	124
	Charger 2.2	1983	1990		
MIRADA		1980	1983	009	227

Model	Includes	Start	End	SAS Model	ModelID
<b>DODGE / 7 (con't)</b>					
ST REGIS	Police, Taxi	1979	1981	010	9
ARIES (K)	Custom, SE, LE (use 9 stiffness for front impacts, size value for side or rear impacts)	1981	1989	011	192
400	LS (use 9 stiffness for front impacts, size value for side or rear impacts)	1983	1983	012	6272
600	ES, Turbo (use 9 stiffness for front impacts, size value for side or rear impacts)	1983	1988	014	191
DAYTONA	Turbo Z, Shelby Z, Pacifica, C/S Competition, IROC R/T (use 9 stiffness for front impacts, size value for side or rear impacts)	1984	1994	015	208
LANCER	Pacifica, Turbo, ES, Shelby (use 9 stiffness for front impacts, size value for side or rear impacts)	1985	1989	016	223
SHADOW	ES, Turbo (use 9 stiffness for front impacts, size value for side or rear impacts)	1987	1998	017	6276
DYNASTY	(use 9 stiffness for front impacts, size value for side or rear impacts)	1988	1998	018	216
SPIRIT	ES, Shelby, R/T (use 9 stiffness for front impacts, size value for side or rear impacts)	1989	1994	019	5
NEON	Expresso (use 9 stiffness for front impacts, size value for side or rear impacts)	1994	1998	020	230
MAGNUM		2005		021	174894
CHARGER (2006+)		2006		024	174896
CALIBER		2007		025	210245
AVENGER ('08 - on)		2008		026	232965
JOURNEY	SE, SXT, R/T	2009		027	260186
CHALLENGER (2008 - ON)		2008		028	263284
CHALLENGER (1978-1983) (ALL IMPORTED)	all imported	1978	1983	033	200
COLT (EXCLUDES VISTA)	RS, Turbo, Custom, GTS, DL, E, Premier, Deluxe Carousel, GT	1974	1976	034	203
	RS, Turbo, Custom, GTS, DL, E, Premier, Deluxe Carousel, GT	1977	1980		
	RS, Turbo, Custom, GTS, DL, E, Premier, Deluxe Carousel, GT: WB<93"	1977	1980		
	RS, Turbo, Custom, GTS, DL, E, Premier, Deluxe Carousel, GT	1980	1994		
CONQUEST	Turbo	1984	1986	035	206
STEALTH		1991	1998	039	10
MONACO		1990	1992	040	228
INTREPID		1993	1998	041	221
AVENGER ('95 - '00)	Model Years 1995 thru 2000	1995	1998	042	196

Model	Includes	Start	End	SAS Model	ModelID
<b>DODGE / 7 (con't)</b>					
STRATUS	(use 9 stiffness for front impacts, size value for side or rear impacts)	1995	1998	043	11
RAIDER	Sport (use 8 stiffness for end impacts, size value for side impacts)	1986	1998	401	127
NITRO		2007		403	232967
RAMCHARGER	(use 8 stiffness for end impacts, size value for side impacts)		1998	421	6278
DURANGO	Use 8 stiffness for end impacts, size value for side impacts.	1998	2000	422	18847
VISTA	4 X 4 (use 7 stiffness for end impacts, size value for side impacts)	1984	1991	441	204
CARAVAN	Mini-Ram, SE, ES: WB=112" (use 7 stiffness for end impacts, size value for side impacts)	1984	1998	442	197
	Mini-Ram, SE, ES: WB=119" (use 7 stiffness for end impacts, size value for side impacts)	1984	1998		
B-SERIES VANS	Sportsman, Royal, Maxiwagon, Ram, B150-B350, Tradesman (use 7 stiffness for front impacts, size value for side or rear impacts)		1998	461	6280
SPRINTER		2004		462	158117
VAN DERIVATIVE	Kary Van (use 7 stiffness for end impacts, size value for side impacts)		1998	470	6282
D50, COLT P/U, RAM 50/RAM 100	D50, Colt P/U (use 8 stiffness for end impacts, size value for side impacts)		1982	471	126
	Ram 50/Ram 100 (use 8 stiffness for end impacts, size value for side impacts)	1983	1998		
DAKOTA	WB=112" (use 8 stiffness for end impacts, size value for side impacts)	1987	1998	472	6284
	WB=124" (use 8 stiffness for end impacts, size value for side impacts)	1987	1998		
D, W-SERIES PICKUP, W100-W350	Ram, Custom, Royal, Miser, D100-D350 (use 8 stiffness for end impacts, size value for side impacts)		1998	481	6287
RAM	1500/2500/3500, P/U (use 8 stiffness for end impacts, size value for side impacts)	1994	1998	482	6289
MEDIUM BUS	not van based		1998	981	20

**EAGLE / 10**

SUMMIT	DL, LX, ES	1989	1998	034	65
TALON	TSI	1990	1998	037	67
PREMIER	LX, ES	1988	1992	040	63
VISION		1993	1998	041	68
MEDALLION	DL, LX	1988	1990	044	62
SUMMIT WAGON	WB=99.2" (use 7 stiffness for end impacts, size value for side impacts)	1992	1998	441	66

**EXCALIBER / 29**

Model	Includes	Start	End	SAS Model	ModelID
<b>EXCALIBER / 29 (con't)</b>					
OTHER AUTOMOBILE			1998	398	9573
UNKNOWN AUTOMOBILE			1998		9574
<b>FERRARI / 69</b>					
SUPERAMERICA		2006		035	210247
<b>FIAT / 36</b>					
124 (COUPE/SEDAN)	Sport	1967	1975	031	6487
124 SPIDER/RACER	Spider 2000/1500	1968	1983	032	766
BRAVA - 131		1975	1982	033	765
850 (COUPE/SPYDER)		1967	1973	034	6489
128		1972	1979	035	6491
X-1/9		1975	1983	036	768
STRADA		1979	1983	037	767
<b>FORD / 12</b>					
FALCON	Sprint, GT, Futura		1970	001	6377
FAIRLANE	Torino		1970	002	6379
MUSTANG/MUSTANG II	Mach, Boss, Granada, Cobra	1965	1973	003	100
	Ghia, SVO, GT, LX, Shelby	1974	1998		
THUNDERBIRD (ALL SIZES)	Landau, Heritage, Turbo coupe, Elan, Fila	1955	1957	004	118
	Landau, Heritage, Turbo coupe, Elan, Fila	1958	1971		
	Landau, Heritage, Turbo coupe, Elan, Fila	1972	1976		
	Landau, Heritage, Turbo coupe, Elan, Fila	1977	1979		
	Landau, Heritage, Turbo coupe, Elan, Fila	1980	1988		
	Landau, Heritage, Turbo coupe, Elan, Fila	1989	1998		
LTD II	S, Squire, Brougham	1977	1979	005	98
LTD/CUSTOM/GALAXIE (ALL SIZES)	XL, Landau, Ranch Wagon, Country Squire, S, 500, Brougham, XL, GT		1977	006	94
	XL, Landau, Ranch Wagon, Country Squire, S, 500, Brougham, XL, GT	1978	1982		
	XL, Landau, Ranch Wagon, Country Squire, S, 500, Brougham, XL, GT	1983	1986		
RANCHERO	Flacon/Fairlane based		1971	007	6381



Model	Includes	Start	End	SAS Model	ModelID
<b>FORD / 12 (con't)</b>					
RANCHERO	Torino/LTD II based	1972	1979	007	6381
MAVERICK	Grabber	1970	1977	008	6384
PINTO	Pony, MPG, ESS (Stiffness for front impacts, Stiffness 2 for rear or side impacts)	1971	1980	009	105
TORINO/GRAN TORINO/ELITE	GT, Cobra, Sport, Squire, Brougham	1971	1976	010	6386
GRANADA	ESS, Ghia	1975	1982	011	6388
FAIRMONT	Futura, Sport Coupe	1978	1983	012	87
ESCORT/EXP	L, GL, GLX, SS, GT, LX, ZX2 (use 9 stiffness for front impacts, size value for side or rear impacts)	1981	1991	013	80
TEMPO	L, GL, GLX, Sport, 4X4 (use 9 stiffness for front impacts, size value for side or rear impacts)	1992	1999	015	115
CROWN VICTORIA		1981	1989	016	79
TAURUS	Mt-5, L, GL, LX, SHO	1986	1989	017	110
PROBE	GL, LX, GT	1988	1998	018	6390
FIVE HUNDRED		2005		021	174898
FREESTYLE		2005		022	174900
FUSION		2006		023	210249
EDGE		2007		024	232969
FLEX	Includes SE, SEL, Limited	2009		025	268100
ENGLISH FORD	Cortina		1998	031	6392
FIESTA	Sport, Ghia	1978	1980	032	92
FESTIVA		1988	1993	033	88
LASER			1998	034	6394
CONTOUR		1994	1998	035	77
ASPIRE	(use 9 stiffness for front impacts, size value for side or rear impacts)	1994	1998	036	76
GT		2004		038	158122
EXPLORER/BRONCO ii/BRONCO (-77)	Bronco (use 7 stiffness for end impacts, size value for side impacts)		1977	401	6396
	Bronco II--Eddie Bauer, XL, XLT, Limited (use 7 stiffness for end impacts, size value for side impacts)	1983	1989		
	Explorer (use 7 stiffness for end impacts, size value for side impacts)	1990	1998		
ESCAPE		2001		402	37748

Model	Includes	Start	End	SAS Model	ModelID
<b>FORD / 12 (con't)</b>					
BRONCO-FULLSIZE	Eddie Bauer, Custom, XL, XLT (use 8 stiffness for end impacts, size value for side impacts)	1978	1998	421	6400
EXPEDITION		1997	1998	422	6402
EXCURSION		2000		431	37078
AEROSTAR	XLT, Cargo Van (use 7 stiffness for end impacts, size value for side impacts)	1984	1998	441	6404
WINDSTAR	(use 7 stiffness for end impacts, size value for side impacts)	1994	1998	442	6406
FREESTAR		2004		443	158120
TRANSIT CONNECT		2010		444	277245
E-SERIES VANS	Econoline, Clubwagon, Chateau, E150-E350 (use 7 stiffness for end impacts, size value for side impacts)		1998	461	6408
VAN DERIVATIVE	Parcel van (use 7 stiffness for end impacts, size value for side impacts)		1998	470	6411
RANGER	Supercab, 4X4, STX, Splash: WB=108" (use 8 stiffness for end impacts, size value for side impacts)	1982	1998	471	6413
	Supercab, 4X4, STX, Splash: WB=108" (use 8 stiffness for end impacts, size value for side impacts)	1982	1998		
COURIER	Imported pickup (use 7 stiffness for end impacts, size value for side impacts)		1998	472	6416
SPORT TRAC		2001		473	44658
F-SERIES PICKUP	F100-F350 (use 8 stiffness for end impacts, size value for side impacts)		1998	481	6418
MEDIUM/HEAVY CBE	F-5 through F-8, L-series, FT-series		1998	881	6420
MEDIUM/HEAVY COE LOW ENGRY	C/Ct series		1998	882	6422
MEDIUM/HEAVY COE HIGH ENTRY	C/CLT series		1998	883	6424
MEDIUM BUS	B-series (not van based)		1998	981	1090

**FREIGHTLINER/WHITE / 82**

SPRINTER/ADVANTAGE		2002		461	104594
MEDIUM/HEAVY TRUCK BASED MOTORHOME			1998	850	9691
MEDIUM/HEAVY - CBE			1998	881	9693
MEDIUM/HEAVY - COE/LOW ENTRY			1998	882	9695
MEDIUM/HEAVY - COE/HIGH ENTRY			1998	883	9697
MEDIUM/HEAVY - UNKNOWN ENGINE LOCATION			1998	884	9699
MEDIUM/HEAVY - COE/ENTRY POSITION UNKNOWN			1998	890	9701
MEDIUM/HEAVY - OTHER			1998	898	9703

**GMC / 23**

Model	Includes	Start	End	SAS Model	ModelID
<b>GMC / 23 (con't)</b>					
CABALLERO/SPRINT	Sierra Madre del Sur, SP (use 8 stiffness for end impacts, size value for side impacts)		1977	007	6687
	Sierra Madre del Sur, SP (use 8 stiffness for end impacts, size value for side impacts)	1978	1998		
ACADIA		2007		008	232971
JIMMY/TYPHOON/ENVOY	S15 based (100.5" WB) (use 7 stiffness for end impacts, size value for side impacts)	1983	1998	401	6690
TERRAIN	SLE, SLT	2009		402	275837
FULLSIZE JIMMY/YUKON	fullsize pickup based (use 8 stiffness for end impacts, size value for side impacts)		1998	421	6692
SUBURBAN	all models (use 8 stiffness for end impacts, size value for side impacts)		1998	431	6694
SAFARI (MINIVAN)	(use 7 stiffness for end impacts, size value for side impacts)	1986	1998	441	6696
G-SERIES VAN	Rally Van, Vandura, G15-G35 (use 7 stiffness for end impacts, size value for side impacts)		1998	461	6698
P-SERIES VAN	(use 7 stiffness for end impacts, size value for side impacts)		1998	466	6700
VAN DERIVATIVE		1987	1987	470	6702
S15/T15/SONOMA	4X4, Cyclone (use 8 stiffness for end impacts, size value for side impacts)	1982	1998	471	6704
CANYON		2004		472	158124
C, K, R, V-SERIES PICKUP	C15-C35, K15-K35, R15-R35, V15-V35, SIERRA (use 8 stiffness for end impacts, size value for side impacts)		1998	481	6706
MEDIUM/HEAVY CBE	W5000/6000/7000 series, Brigadier/General models		1998	881	6709
MEDIUM/HDAVY COE LOW ENTRY	W6000/W7000, all other COE, low entry		1998	882	6711
MEDIUM/HEAVY COE HIGH ENTRY	Astro 95, all other COE, high entry		1998	883	6713
MEDIUM/HEAVY: UNKNOWN ENGINE LOCATION			1998	884	6715
MEDIUM BUS	B6000		1998	981	920

**GRUMMAN / 25**

LLV	Postal vehicles (see Chevrolet for VIN)		1998	441	6727
STEP-IN VAN	Multi-stop, step van		1998	442	6729
BUS-FLAT FRONT, REAR ENGINE	Transit		1998	983	6736

**HONDA / 37**

CIVIC/CRX/DEL SOL	1300, 1500, CVCC, DX, EX, VX, CRX, S, Si, HF, 4WD Wagon		1998	031	775
	del Sol	1993	1998		

Model	Includes	Start	End	SAS Model	ModelID
<b>HONDA / 37 (con't)</b>					
ACCORD	LX, CVCC, SE-i, LX-i, EX, EX wagon		1981	032	774
	LX, CVCC, SE-i, LX-i, EX, EX wagon (use 9 stiffness for front impacts, size value for side or rear impacts)	1982	1986		
	LX, CVCC, SE-i, LX-i, EX, EX wagon, 6 cylinder LX/EX (use 9 stiffness for front impacts, size value for side or rear impacts)	1987	1998		
PRELUDE	Si	1980	1983	033	651
	Si (use 9 stiffness for front impacts, size value for side or rear impacts)	1984	1998		
600	Coupe, Sedan		1998	034	6504
S2000		2000		035	31630
INSIGHT		2000		037	37080
FCX		2004		038	158126
FIT		2006		039	210251
PASSPORT	(use 8 stiffness for end impacts, size value for side impacts)	1994	1998	401	6506
CR-V	(use 8 stiffness for end impacts, size value for side impacts)	1997	2000	402	16407
ELEMENT		2003		403	146526
PILOT		2003		421	146528
ODYSSEY	(use 7 stiffness for end impacts, size value for side impacts)	1995	1998	441	650
RIDGELINE		2006		471	174902

**HUDSON / 29**

OTHER AUTOMOBILE			1998	398	9577
UNKNOWN AUTOMOBILE			1998		9587

**HYUNDAI / 55**

PONY		1984	1988	031	7878
EXCEL	GL, GLS	1984	1994	032	480
SONATA		1989	1998	033	482
SCOUPE		1991	1995	034	7880
ELANTRA		1992	1998	035	7882
ACCENT		1995	1998	036	7884
TIBURON		1997	1998	037	7886

Model	Includes	Start	End	SAS Model	ModelID
<b>HYUNDAI / 55 (con't)</b>					
XG300/350		2001		038	44659
AZERA		2006		039	210253
EQUUS		2008		040	233005
GENESIS	3.8, 4.6	2009		041	269395
SANTA FE		2000		401	31626
TUCSON		2005		402	174904
VERACRUZ		2007		403	233007
ENTOURAGE		2007		441	233013

**IMPERIAL / 8**

IMPERIAL	Lebaron		1976	010	6297
	Mark Croww, Frank Sinatra editions	1981	1983		

**INFINITI / 58**

M30		1990	1992	031	444
Q45		1990	1998	032	445
G20		1991	1996	033	442
		1999	2000		
J30		1993	1998	034	443
I30		1996	1998	035	7896
I35		2002		036	146530
G35/G37		2003		037	146532
M35/M45		2003		038	146534
FX35/45/50	FX50 (2009 - )	2003		039	146536
EX35	Includes Journey	2008		040	260573
QX4		1997	1998	401	7898
QX56		2004		421	158128

**INTERNATIONAL HARVESTER**

SCOUT	Scout II, Utility pu, SS-2, Roadstar, 800 series, Traveler, Terra Traveltop (use 8 stiffness for front and rear impacts, size value for side impacts)		1998	421	9632
TRAVELALL	1010-1210, 100-200 (use 8 stiffness for front and rear impacts, size value for side impacts)		1998	431	9634

Model	Includes	Start	End	SAS Model	ModelID
<b>INTERNATIONAL HARVESTER</b>					
MULTISTOP VAN	Metro RM, 120-160, MS 1210, MS 1510 (use 7 stiffness for front and rear impacts, size value for side impacts)		1998	466	9636
PICKUP	R-100-500, 900A-1500C/D, 1010-1510 (use 8 stiffness for front and rear impacts, size value for side impacts)		1998	481	9638
MEDIUM HEAVY - CBE	Loadstar/Fleetstar, Paystar, CBE Transtar, 4200, S-series Mixer		1998	881	9641
MEDIUM/HEAVY - COE LOW ENTRY	CO, VCO, DCO, 190-1950, Cargostar, LFM, 5370 (Garbage)		1998	882	9643
MEDIUM/HEAVY - COE HIGH ENTRY	DCO, DCOT, UCO, VCOT, 405-series, COE Transtar, Unistar, Conco 707B, 9600		1998	883	9645
OTHER MEDIUM/HEAVY TRUCK	Fire Truck - R140-R306, CO 8190-		1998	898	231
CONVENTIONAL BUS	R153-1853 - Loadstar, 1603-1853		1998	981	9649
BUS-FLAT FRONT, FRONT ENGINE	173FC, 183FC		1998	982	9651
BUS-FLAT FRONT, REAR ENGINE	183RE, 193RD-transit		1998	983	9653

**ISUZU / 38**

I-MARK	S, RS, Turbo	1985	1989	031	672
IMPULSE	Turbo, RS	1984	1998	032	673
STYLUS		1990	1998	033	677
TROOPER/TROOPER II	Deluxe, LS (use 8 stiffness for end impacts, size value for side impacts)	1984	1998	401	678
RODEO	(use 8 stiffness for end impacts, size value for side impacts)	1991	1998	402	676
AMIGO	(use 8 stiffness for end impacts, size value for side impacts)	1989	1994	403	671
VEHICROSS		1999		404	37454
AXIOM		2002		405	44662
ASCENDER		2003		421	146538
OASIS	(use 7 stiffness for end impacts, size values for side impacts)	1996	1998	441	674
P'UP (PICKUP) HOMBRE	4x4 (use 8 stiffness for end impacts, size value for side impacts)		1995	471	675
	Hombre (use 8 stiffness for end impacts, size value for side impacts)	1996	1998		
i-280/i-290	S, LS, Luxury	2006		473	210258
i-350/i-370	LS, Limited, S	2006		474	210260

**JAGUAR / 39**

XJ-S COUPE		1976	1998	031	688
------------	--	------	------	-----	-----

Model	Includes	Start	End	SAS Model	ModelID
<b>JAGUAR / 39 (con't)</b>					
XJ6/12 SEDAN/COUPE/XJ8/	L, XJ, C, 340/420 Sedan		1998	032	691
VANDEN PLAS		1999	2000		20220
XKE	V12, Roadster, 120		1998	033	6531
	2+2		1998		
X100		1997	1998	034	6534
S-TYPE		2000			40034
X-TYPE		2000		035	44661

**JEEP / KAISER-JEEP / 2**

COMPASS		2007		001	233015
CJ-2/CJ-3/CJ-4	Military: WB=81" (use 8 stiffness for end impacts, size value for side impacts)		1966	401	6169
	Military: WB=101" (use 8 stiffness for end impacts, size value for side impacts)		1966		
CJ-5/CJ-6/CH-7/CH-8	Scrambler, Bolde Eagle, Renegade, Laredo, Wrangler: WB=104" (use 8 stiffness for end impacts, size value for side impacts)	1967	1998	402	6174
	Scrambler, Bolde Eagle, Renegade, Laredo, Wrangler: WB=84" (use 8 stiffness for end impacts, size value for side impacts)	1967	1998		
YJ-SERIES/WRANGLER	Wrangler (use 8 stiffness for end impacts, size value for side impacts)	1986	2009	403	6178
CHEROKEE (1984 ON)	Limited, Loreda, Pioneer, Briarwood (use 8 stiffness for end impacts, size value for side impacts)	1984	1998	404	6180
	Grand (use 8 stiffness for end impacts, size value for side impacts)	1992	1998		
LIBERTY		2002		405	45081
COMMANDER		2006	2009	406	210262
PATRIOT		2007		407	233019
CHEROKEE (1963 - 1983)	Wide Track, Chief, Commando, Jeepster (use 8 stiffness for end impacts, size value for side impacts)	1963	1983	421	6183
GRAND WAGONEER	Custom, Bougham Limited (use 8 stiffness for end impacts, size value for side impacts)	1971	1991	431	6186
	Wagoneer (use 8 stiffness for end impacts, size value for side impacts)	1971	1991		
PICKUP	J-10, J-20, Honcho (use 8 stiffness for end impacts, size value for side impacts)		1998	481	6189
COMANCHE	Chief: WB=111" (use 8 stiffness for end impacts, size value for side impacts)	1986	1992	482	6191
	Chief: WB=119" (use 8 stiffness for end impacts, size value for side impacts)	1986	1992		

**JENSEN / 69**

Model	Includes	Start	End	SAS Model	ModelID
<b>JENSEN / 69 (con't)</b>					
HEALY			1998	037	9603
<b>KIA / 63</b>					
SEPHIA	(use 9 stiffness for front impacts, size value for side or rear impacts)		1998	031	471
SPECTRA		2000		032	38480
RIO/RIO 5		2000		033	38482
OPTIMA		2001		034	38484
AMANTI		2004		035	158130
RONDO		2008		036	233021
SOUL		2009		037	269675
FORTE		2010		038	270415
SPORTAGE	(use 8 stiffness for end impacts, size value for side impacts)	1996	1998	401	472
SORENTO		2003		402	146540
BORREGO	includes EX, LX (Body Type = 15/Large utility)	2009		421	274503
SEDONA		2002		441	45083
<b>LAMBORGHINI / 69</b>					
COUNTACH 5000S			1998	038	9605
JALPA			1998		9607
<b>LANCIA / 40</b>					
BETA SEDAN-HPE			1980	031	696
BETA COUPE - ZAGATO			1982	032	697
SCORPION			1978	033	6538
<b>LAND ROVER / 62</b>					
DISCOVERY (LR)	(use 8 stiffness for end impacts, size value for side impacts)	1994	1998	401	7914
RANGE ROVER	County LWB (RR) (use 8 stiffness for end impacts, size value for side impacts)		1994	421	7918
	County Classic (RR) (use 8 stiffness for end impacts, size value for side impacts)	1994	1998		
DEFENDER 90 (LR)	(use 8 stiffness for end impacts, size value for side impacts)	1994	1998	422	7916
4.0 SE (RR)	(use 8 stiffness for end impacts, size value for side impacts)	1995	1998		7922
FREELANDER		2002			146542



Model	Includes	Start	End	SAS Model	ModelID
<b>LAND ROVER / 62 (con't)</b>					
LR3		2005		423	174906
LR2		2007		424	233023

**LEXUS / 59**

ES-250/300/330/350		1990	1998	031	449
LS	Includes 400/430/460/L/600h/L	1990		032	452
SC-300/SC-400	2-door Coupe	1992	1998	033	453
GS-300/350/400/430/450h	Includes Hybrid	1993		034	451
IS-250/300/350/500		2001		035	37082
SC 430		2002		036	133514
RX300	(use 8 stiffness for end impacts, size value for side impacts)	1999	2000	401	20801
GX470		2003		402	146552
RX330/350/400h	Hybrid, Thundercloud, Mark Levinson Package	2004		403	263711
LX 450/470	(use 8 stiffness for end impacts, size value for side impacts)	1996		421	7906

**LINCOLN / 13**

CONTINENTAL/TOWN CAR	Continental		1979	001	1099
	Continental	1980	1981		
	Town Car	1982	1998		
MARK	I, II, III, IV, V		1970	002	1096
	LSC, all Signature/Designer Series	1971	1980		
	VI	1980	1983		
	VII	1984	1998		
	VII	1993	1998		
CONTINENTAL (82-ON)	All Signature/Designer Series	1982	1987	005	6438
	All Signature/Designer Series	1988	1998		
VERSAILLES		1977	1980	011	1100
LS		2000	2000	012	20803
ZEPHYR / MKZ		2006		013	210264
MKX		2007		014	233036

Model	Includes	Start	End	SAS Model	ModelID
<b>LINCOLN / 13 (con't)</b>					
MKS		2008		015	233038
MKT		2009		016	276053
AVIATOR		2003		401	146554
NAVIGATOR	(use 8 stiffness for end impacts, size value for side impacts)	1997	1998	421	6441
BLACKWOOD		2002		481	44663
MARK LT		2006		482	174909
<b>LOTUS / 69</b>					
EUROPE			1998	039	9609
ESPRIT			1998		9611
ELISE		2005			193699
<b>MASERATI / 69</b>					
BITURBO			1998	040	9613
<b>MAZDA / 41</b>					
RX2		1972	1974	031	6553
RX3		1972	1978	032	6555
RX4		1974	1978	033	6557
RX7	S, GS, GSL, SE	1979	1998	034	714
GLC/PROTEGE/323	323	1977	1994	035	701
	DX	1977	1998		
	Protege	1990	1998		
COSMO		1976	1978	036	6559
626	GT, GS, GSL, SE	1979	1998	037	702
808		1972	1977	038	6563
MIZER		1976	1976	039	6565
R-100			1972	040	6567
616/618			1972	041	6569
1800			1972	042	6571
929		1988	1996	043	703

Model	Includes	Start	End	SAS Model	ModelID
<b>MAZDA / 41 (con't)</b>					
MX-6	Turbo	1988	1998	044	712
MIATA		1990	1998	045	711
MX-3	GS	1992	1998	046	710
MILLENNIA		1995	1998	047	708
MP3		2001		048	45085
RX-8		2003		049	146556
MAZDA 6		2003		050	146558
MAZDA3		2004		051	158132
MAZDA 5		2006		052	210266
CX-7		2007		053	210268
CX9		2007		054	233040
NAVAJO	(use 8 stiffness for end impacts, size value for side impacts)	1991	1998	401	6573
TRIBUTE		2000		402	31624
MPV	(use 7 stiffness for end impacts, size value for side impacts)	1989	1998	441	709
MAZDA PICKUP	B-2000, B-2200, B-2600, SE-5, LX (use 8 stiffness for end impacts, size value for side impacts)		1998	471	704
	Cab Plus, B-4000 (use 8 stiffness for end impacts, size value for side impacts)	1994	1998		

**MERCEDES BENZ / 42**

200/220/230/240/250/260/280/300/320 SE,CD,D,SD,ETC	Sedan and 5 passenger "C" only, SE, CD, D, SD, TD, TE, CE, E, (DOES NOT include 280 SE) (75 on)		1998	031	725
230/280 SL	2 seater only		1998	032	6588
300/350/380/450/500SL/560SL	2 seater only		1994	033	632
	300/500 SL	1990	1994		
350/380/420/450/560/ SLC			1998	034	6593
280/300SEL			1998	035	616
380/420/450/500/560SEL/500SEC/560SEC/350SDL/300SDL			1998	036	631
300 SE/380/450 SE	280 S, 300 SD Sedan/350 SD		1998	037	621
	280 SE	1975	1998		
600, 6.9 SEDAB	Pullman		1998	038	633
190	D, E, 2.3, 2.5		1998	039	720

Model	Includes	Start	End	SAS Model	ModelID
<b>MERCEDES BENZ / 42 (con't)</b>					
300	CE Cabriolet	1993	1998	040	727
400/500 E	SE	1992	1998	041	641
C CLASS (94 on)	C220/C230 (Kompressor)/C240/C280/C320/C300/C350/C36/C43 , C32/55/63 AMG	1994		042	636
SLK		1998		045	22156
CL		1998		046	22158
CLK		1998		047	22160
SLR MCLAREN		2005		049	174911
R-CLASS		2006		050	210270
CLS CLASS		2006		051	210272
M	(use 8 stiffness for end impacts, size value for side impacts)	1997	2000	401	6597
G CLASS		2002		402	45087
VAN DERIVATIVE	Kurbstar	1982	1998	470	6600

**MERCURY / 14**

CYCLONE	GT, CJ, Spoiler		1971	002	6467
CAPRI-DOMESTIC	RS, Turbo, GS, Black Magic	1979	1986	003	1105
COUGAR/XR7	XR-7, RS, LS, GS, Eliminator, Brougham, Villager, (includes all body styles)	1967	1976	004	1109
	XR-7, RS, LS, GS, Eliminator, Brougham, Villager, (includes all body styles): WB=114"	1977	1979		
	XR-7, RS, LS, GS, Eliminator, Brougham, Villager, (includes all body styles): WB=118"	1977	1979		
	XR-7, RS, LS, GS, Eliminator, Brougham, Villager, (includes all body styles)	1980	1988		
	XR-7, RS, LS, GS, Eliminator, Brougham, Villager, (includes all body styles)	1989	1998		
MARQUIS/MONTEREY	Marauder, X-100, Parklane, S-55, Custom, Brougham, Montclair, Grand Marquis: WB=121"		1978	006	1108
	Marauder, X-100, Parklane, S-55, Custom, Brougham, Montclair, Grand Marquis: WB=124"		1978		
	Marauder, X-100, Parklane, S-55, Custom, Brougham, Montclair, Grand Marquis	1979	1982		
	Marauder, X-100, Parklane, S-55, Custom, Brougham, Montclair, Grand Marquis: WB=106"	1982	1998		
	Marauder, X-100, Parklane, S-55, Custom, Brougham, Montclair, Grand Marquis: WB=114"	1982	1998		
COMET	Caliente, GT, Voyager, 202	1962	1967	008	6469
	Capri	1966	1967		

Model	Includes	Start	End	SAS Model	ModelID
<b>MERCURY / 14 (con't)</b>					
COMET	Caliente, GT, Voyager, 202	1971	1977	008	6469
BOBCAT	Runabout, Villager (Stiffness 1 for front and side impacts, Stiffness 2 for rear impacts)	1975	1980	009	1104
MONTEGO	Comet	1968	1970	010	6473
	GT, MX, Villager, Brougham	1968	1973		
	GT, MX, Villager, Brougham: WB=114"	1972	1976		
	GT, MX, Villager, Brougham: WB=114"	1972	1976		
MONARCH	Ghia	1975	1980	011	1119
ZEPHYR	GS, Z-7	1978	1983	012	1131
LYNX/LN-7 (82-83)	L, LS, GS, RS, XR-3 (use 9 stiffness for front impacts, size value for side or rear impacts)	1981	1987	013	1113
TOPAZ	L, LS, GS, 4 X 4 (use 9 stiffness for front impacts, size value for side or rear impacts)	1984	1998	015	1124
SABLE	LS, GS	1986	1998	017	1121
MONTEGO (2005+)		2005		020	174913
MILAN		2006		021	210274
CAPRI-FOREIGN	Capri II	1970	1977	031	1106
	2 + 2	1989	1994		
PANTERA	deTomaso	1972	1974	033	6478
TRACER	L, GL	1994	1998	036	1129
MYSTIQUE	(use 9 stiffness for front impacts, size value for side or rear impacts)	1994	1998	037	1120
MARAUDER		2003		039	146560
MOUNTAINEER	(use 7 stiffness for end impacts, size value for side impacts)	1996	1998	401	6480
MARINER		2005		402	174915
VILLAGER	LS, GS (use 7 stiffness for end impacts, size value for side impacts)	1993	1998	443	6482
MONTEREY (2004+)		2004		444	158134
<b>MERKUR / 56</b>					
XR4Ti	Turbo	1985	1989	031	487
SCORPIO	Turbo	1987	1990	032	486
<b>MG / 43</b>					
MGB ('76-'79)		1976	1979	032	6621

Model	Includes	Start	End	SAS Model	ModelID
<b>MG / 43 (con't)</b>					
MGB ('67-'75)	GT	1967	1975	033	6623
MGA			1998	034	6625
TA/TC/TD/TF			1998	035	6627
MGC	GT		1969	036	6629

**MINI / 69**

COOPER,COOPER S		2002		054	143056
-----------------	--	------	--	-----	--------

**MITSUBISHI / 52**

STARION	2+2, LE, Turbo	1983	1990	031	391
TREDIA	L, LS, Turbo	1983	1988	032	393
CORDIA	L, Turbo	1983	1988	033	382
GALANT	Sigma	1985	1988	034	384
	ECS	1985	1998		
MIRAGE	L, Turbo	1985	1998	035	385
ECLIPSE		1990	1998	037	383
SIGMA		1989	1990	038	390
3000GT	Spyder, VR-4	1991	1998	039	381
DIAMANTE		1992	1998	040	6819
LANCER		2002		046	46434
MONTERO	Sport (use 8 stiffness for end impacts, size value for side impacts)	1985	1998	401	386
OUTLANDER		2003		402	146562
ENDEAVOR		2004		403	158136
MINIVAN	LS (use 8 stiffness for end impacts, size value for side impacts)	1987	1998	441	395
EXPO WAGON	LRV, Sport WB=99.2" (use 7 stiffness for end impacts, size value for side impacts)	1992	1995	442	396
	LRV, Sport WB=107.1" (use 7 stiffness for end impacts, size value for side impacts)	1992	1995		
PICKUP	Mighty Max, SPX, 4 X 4 (use 8 stiffness for end impacts, size value for side impacts)		1998	471	389
RAIDER/DUROCROSS		2006		472	233043
MEDIUM/HEAVY - COE LOW ENTRY	FUSO FE		1998	882	6821

**MORRIS / 69**

Model	Includes	Start	End	SAS Model	ModelID
<b>MORRIS / 69 (con't)</b>					
MINOR			1998	041	9615
<b>NISSAN / DATSUN / 35</b>					
F10		1977	1978	031	6855
200/240 SX		1974	1983	032	846
		1984	1998		
1200/210/B210	Honeybee	1971	1982	033	842
Z-CAR, ZX	240/260/280Z, 300 ZX, Turbo	1970	1998	034	849
	2+2	1975	1978		
	2+2	1979	1998		
310		1979	1982	035	843
510	PL	1968	1973	036	844
	PL	1978	1981		
610	PL	1973	1976	037	6857
710	PL	1974	1977	038	6859
810/MAXIMA		1977	1998	039	738
ROADSTER	SPL 311, SRL 311, 1600, 2000, convertible		1970	040	6861
PL411, RL411			1967	041	6863
STANZA	XE	1982	1992	042	756
SENTRA		1983	1998	043	750
PULSAR	NX	1983	1990	044	745
	EXA	1986	1990		
MICRA		1987	1998	045	6865
NX 1600/2000		1992	1998	046	742
ALTIMA		1993	1999	047	12227
350Z/370Z	370Z included on 11/17/09	2003		048	158138
MURANO		2003		049	158140
VERSA		2007		050	210276
ROGUE	Includes S, SL.	2008		051	261329

Model	Includes	Start	End	SAS Model	ModelID
<b>NISSAN / DATSUN / 35 (con't)</b>					
CUBE		2010		052	271535
PATHFINDER	(use 8 stiffness for end impacts, size value for side impacts)	1986	1998	401	6867
XTERRA		2000		402	31619
PATHFINDER ARMADA		2004		421	158142
VAN	XE, GXE (use 7 stiffness for end impacts, size value for side impacts)	1988	1998	441	757
AXXESS	(use 7 stiffness for end impacts, size value for side impacts)	1989	1990	442	6833
QUEST	(use 7 stiffness for end impacts, size value for side impacts)	1993	1998	443	747
DATSUN/NISSAN PU/Frontier	PL620, King Cab, Hardbody (use 8 stiffness for end impacts, size value for side impacts)	1973	1998	471	743
TITAN		2004		481	158144
OTHER LIGHT TRUCK	Patrol (1960) (use 8 stiffness for end impacts, size value for side impacts)		1998	498	760

**OLDSMOBILE / 21**

CUTLASS (RWD-ONLY)	F85		1972	001	1052
	Supreme, S, LS, Salon, Brougham, Vista Cruiser, Rallye 350, Hurst Olds, 442, Calais (use 9 stiffness for front impacts, size value for side or rear imp)		1977		
	Supreme, S, LS, Salon, Brougham, Vista Cruiser, Rallye 350, Hurst Olds, 442, Calais	1978	1988		
	Classic	1988	1988		
DELTA 88	Starfire		1966	002	1051
	Royale, Custom, Delta, Jetstar 88, Delmont 88, Custom Cruiser		1976		
	Royale, Custom, Delta, Jetstar 88, Delmont 88, Custom Cruiser	1977	1985		
	Royale, Custom, Delta, Jetstar 88, Delmont 88, Custom Cruiser (use 9 stiffness for front impacts, size value for side or rear impacts)	1985	1998		
NINETY-EIGHT	Regency, Luxury		1976	003	1071
	Regency, Luxury	1977	1984		
	Regency, Luxury	1986	1998		
TORONADO-TROFEO	XSR, Trofeo, Brougham, Custom	1966	1978	005	1079
	XSR, Trofeo, Brougham, Custom	1979	1985		
	XSR, Trofeo, Brougham, Custom	1986	1992		
COMMERCIAL SERIES	Ambulance/Hearse		1998	006	6646



Model	Includes	Start	End	SAS Model	ModelID
-------	----------	-------	-----	-----------	---------

**OLDSMOBILE / 21 (con't)**

STARFIRE	SX, GT	1975	1980	012	1078
OMEGA	RWD	1975	1979	015	1076
	X-body type FWD (use 9 stiffness for front impacts, size value for side or rear impacts)	1980	1985		
FIRENZA	S, LS, SX, Cruiser, GT (use 9 stiffness for front impacts, size value for side or rear impacts)	1982	1988	016	1069
CIERA	Cutlass Ciera, Brougham, ES (use 9 stiffness for front impacts, size value for side or rear impacts)	1982	1998	017	1054
CALAIS	GT, ES, 500 (use 9 stiffness for front impacts, size value for side or rear impacts)	1985	1991	018	1050
CUTLASS (FWD)	Supreme (use 9 stiffness for front impacts, size value for side or rear impacts)	1988	1998	020	1060
ACHIEVA	SC (use 9 stiffness for front impacts, size value for side or rear impacts)	1992	1998	021	1046
AURORA	(use 9 stiffness for front impacts, size value for side or rear impacts)	1994	1998	022	1049
BRAVADA	(use 7 stiffness for end impacts, size value for side impacts)	1991	1994	401	22171
SILHOUETTE	(use 7 stiffness for end impacts, size value for side impacts)	1990	1998	441	1077

**OTHER MAKE MOTORED CYCL**

0-50cc			1998	701	9625
51-124cc			1998	702	9626
125-349cc			1998	703	9627
350-449cc			1998	704	9628
450-749cc			1998	705	9629
750c or greater			1998	706	9630
Unknown cc			1998	709	9631

**PEUGEOT / 44**

304		1971	1973	031	6635
403			1967	032	6637
404			1970	033	6639
	Station Wagon		1970		
504/505	Station Wagon	1970	1991	034	6642
	STI, STX, Turbo, S, GL GLS, Liberte	1970	1991		
604	SL, D	1977	1984	035	6645

Model	Includes	Start	End	SAS Model	ModelID
<b>PEUGEOT / 44 (con't)</b>					
405	(use 9 stiffness for front impacts, size value for side or rear impacts)	1989	1991	036	6647
<b>PLYMOUTH / 9</b>					
VALIANT/DUSTER/SCAMP	100, 200, Brougham, Signet, Custom, Special, 340/360, Twister: WB=108"		1976	001	6320
	100, 200, Brougham, Signet, Custom, Special, 340/360, Twister: WB=111"		1976		
SATELLITE/BELVEDERE	Belveder I/II, GTX, Roadrunner, Sebring, Sebring Plus, Superbird, Brougham		1974	002	6323
FURY	I, II, III		1974	003	6325
	Roadrunner	1975	1975		
	Salon, VIP, Sport, Suburban	1975	1978		
GRAN FURY	Sedan, Brougham, Custom Sport, Suburban	1975	1981	004	36
	Sedan, Brougham, Custom Sport, Suburban	1982	1989		
BARRACUDA	Formula, S, 340, AAR, 'Cuda, Gran Coupe	1965	1973	005	6329
VOLARE	Custom, Premier, Roadrunner, Police: WB=109"	1976	1980	006	53
	Custom, Premier, Roadrunner, Police: WB=113"	1976	1980		
CARAVELLE	Turbo, SE (use 9 stiffness for front impacts, size value for side or rear impacts)	1985	1989	007	29
HORIZON	TC-3, Miser, Turismo 2.2, Custom, SE, America Expo	1978	1990	008	40
	Duster	1985	1990		
RELIANT (K)	SE, LE (use 9 stiffness for front impacts, size value for side or rear impacts)	1981	1989	011	44
SCAMP (CAR BASED PICKUP)	GT, 2.2	1982	1984	013	6331
SUNDANCE	Turbo (use 9 stiffness for front impacts, size value for side or rear impacts)	1987	1998	017	47
ACCLAIM	LX, LE (use 9 stiffness for front impacts, size value for side or rear impacts)	1989	1998	019	27
NEON	Espresso (use 9 stiffness for front impacts, size value for side or rear impacts)	1994	1998	020	42
CRICKET		1971	1972	031	32518
ARROW	Fire Arrow, GS, GT	1976	1980	032	28
SAPPORO	all imported	1978	1983	033	46
CHAMP/COLT (EXCLUDES VISTA)	Turbo, Custom	1979	1994	034	30
	Station Wagon (WB=103")	1984	1994		
CONQUEST	TSI	1984	1989	035	34

Model	Includes	Start	End	SAS Model	ModelID
<b>PLYMOUTH / 9 (con't)</b>					
LASER	RS, Turbo	1989	1998	037	41
BREEZE	(use 9 stiffness for front impacts, size value for side or rear impacts)	1996	1998	038	6333
TRAILDUSTER	(use 8 stiffness for end impacts, size value for side impacts)		1998	421	6337
COLT VISTA	4 X 4 (use 7 stiffness for end impacts, size value for side impacts)	1987	1998	441	32
VOYAGER (MINIVAN)	SE, LX: WB=112" (use 7 stiffness for end impacts, size value for side impacts)	1984	1998	442	37
	SE, LX: WB=119" (use 7 stiffness for end impacts, size value for side impacts)	1984	1998		
VAN-FULLSIZE (B-SERIES)	Includes Voyager, Sport, Premier (Use 7 for end impacts, size category for side impacts)	1965	1995	461	32520
ARROW PICKUP (FOREIGN)	(use 8 stiffness for end impacts, size value for side impacts)		1998	471	6341

**PONTIAC / 22**

LEMANS/TEMPEST (THRU 79)	Safari, T-37, Luxury, Grand Sport, GTO, GT-37, Sprint, Grand Lemans		1973	001	893
	Safari, T-37, Luxury, Grand Sport, GT-37, Sprint, Judge Grand AM, Grand Lemans	1973	1975		
	Safari, T-37, Luxury, Grand Sport, GT-37, Sprint, Grand Lemans	1976	1977		
	Safari, T-37, Luxury, Grand Sport, GT-37, Sprint, Grand Lemans	1978	1979		
BONNEVILLE/CATALINA/PARISIE NNE	Brougham, Gand Safari, Safari, Granville, 2+2 Executive, Starchief		1968	002	895
	Brougham, Gand Safari, Safari, Granville, 2+2 Executive, Starchief	1969	1976		
	Brougham, Gand Safari, Safari, Granville, 2+2 Executive, Starchief	1977	1981		
	Brougham, Gand Safari, Safari, Granville, 2+2 Executive, Starchief	1982	1984		
	Parisienne	1983	1984		
	SE, SSE, SSEi	1987	1998		
FIERO	2M4, 2M6, GT, SE	1984	1988	005	873
VENTURA/GTO	II, SJ, Sprint, Custom	1971	1977	008	6681
	GTO	1974	1977		
	GTO	2004	2006		
FIREBIRD/TRANS AM	Esprit, Formula, GTA, Redbird, Yellowbird, Skybird, SE	1967	1981	009	875
	Esprit, Formula, GTA, Redbird, Yellowbird, Skybird, SE	1982	1998		
GRAND PRIX (RWD)	J, LJ, SJ, Brougham, 2+2	1963	1972	010	885

Model	Includes	Start	End	SAS Model	ModelID
<b>PONTIAC / 22 (con't)</b>					
GRAND PRIX (RWD)	J, LJ, SJ, Brougham, 2+2	1973	1977	010	885
	J, LJ, SJ, Brougham, 2+2	1978	1987		
ASTRE	Safari, SJ, Custom	1975	1977	011	6684
SUNBIRD (THRU 80)	Safari, Sport, Formula	1976	1980	012	897
T1000/1000	2 door	1981	1987	013	905
	4 door	1981	1987		
PHOENIX	LJ, SJ	1977	1979	015	896
	LJ, SJ (use 9 stiffness for front impacts, size value for side or rear impacts)	1980	1984		
J2000/SUNBIRD/SUNFIRE	Le, Se, GT, Convertible (use 9 stiffness for front impacts, size value for side or rear impacts)	1982	1994	016	901
	Sunbird (use 9 stiffness for front impacts, size value for side or rear impacts)	1984	1994		
	Sunfire-GT/SE (use 9 stiffness for front impacts, size value for side or rear impacts)	1995	1998		
6000	STE, SE, LE (use 9 stiffness for front impacts, size value for side or rear impacts)	1982	1998	017	858
GRAND AM	SE, LE	1980	1980	018	881
	SE, LE (use 9 stiffness for front impacts, size value for side or rear impacts)	1985	1998		
G5		2007		019	233045
GRAND PRIX (FWD)	SE, McLaren Turbo, GTP (use 9 stiffness for front impacts, size value for side or rear impacts)	1988	1998	020	886
G6		2005		022	174917
SOLSTICE		2006		023	210278
G8	Includes GT.	2008		024	261331
G3		2009		025	279912
LEMANS (88-on)	SE, Tempest (Canadian)	1988	1998	031	894
VIBE	Includes GT, AWD	2003		032	45089
AZTEK		2001		401	40755
TORRENT		2006		403	210280
TRANS SPORT/MONTANA	(use 7 stiffness for end impacts, size value for side impacts)	1990	1998	441	906

**PORSCHE / 45**

911	L, S, E, T, SC, Carrera, Slopenose, Speedstar		1998	031	516
-----	---	--	------	-----	-----

Model	Includes	Start	End	SAS Model	ModelID
<b>PORSCHE / 45 (con't)</b>					
911	Panorama	1996	1998	031	516
912	E, T		1969	032	6654
914	S, 1.8, 2.0, 914/6	1970	1976	033	6656
924	Turbo, S	1977	1988	034	513
928	S	1978	1998	035	514
930	Turbo	1989	1994	036	6658
944	Turbo, S	1983	1992	037	515
959		1989	1994	038	6661
968		1992	1995	039	6663
CAYMAN		2006		041	210282
OTHER AUTOMOBILE	Spyder, Speedster, 356		1998	398	518
CAYENNE		2003		421	158146

**RENAULT/AMC / 46**

LECAR	5	1976	1983	031	521
DAUPHINE/10/R-8/CARAVELLE			1971	032	6671
12	R12L, R12TL	1972	1977	033	6674
15	R14TL	1973	1976	034	6676
16	R16	1969	1972	035	6678
17	R17, Gordini Coupe, R17TL	1973	1980	036	6680
R18I	Sportwagon	1981	1998	037	522
FUEGO	TL, TS, GTL, GTS, Turbo	1982	1985	038	525
ALLIANCE/ENCORE/GTA, CONVERTIBLE	L, DL, Limited, X-37	1983	1998	039	523
ALPINE	GT	1987	1998	041	6682
MEDALLION	DL, LX	1987	1987	044	526
PREMIER		1987	1987	045	6685

**ROLLS ROYCE/BENTLEY / 69**

CLOUD/SHADOW SERIES			1998	042	261
---------------------	--	--	------	-----	-----

**SAAB / 47**

Model	Includes	Start	End	SAS Model	ModelID
<b>SAAB / 47 (con't)</b>					
99/99E/900	S, Turbo, Cabriolet		1998	031	530
SONNETT	II, III, V-4	1968	1974	032	6707
95/96/97			1973	033	6710
9000, CS	S, Trubo	1985	1998	034	531
	CS	1993	1998		
9-2X		2005		037	174919
9-7X		2005		401	174921

**SATURN / 24**

SL	SL1, SL2, SL3	1991	1998	001	6719
SC	SC1, SC2	1991	1996	002	6721
	includes 3 door coupe	1997	2000		
SW	SW1, SW2	1993	1998	003	6723
EV	EV1 (electric vehicle)	1997	1998	004	6725
LS/ LS1/ LS2/L100/L200/L300		2000		005	31617
LW/LW1/ LW2/ LW200/300		2000		006	37084
ION		2003		007	148360
SKY		2007		008	210286
AURA		2007		009	210284
OUTLOOK	XE, XR (Body Type = S/W)	2007		010	260188
ASTRA	XE, XR, Sport (Body Types: 03 & 05)	2008		011	260190
VUE		2002		401	45091
RELAY		2005		441	174925

**SMART / 65**

FORTWO	Includes Pure & Passion	2008		031	263033
OTHER AUTOMOBILE		2008		398	263038
UNKNOWN AUTOMOBILE		2008		399	263039

**STERLING / 61**

827S	Li	1986	1991	031	7912
------	----	------	------	-----	------

**STUDEBAKER / 29**

Model	Includes	Start	End	SAS Model	ModelID
<b>STUDEBAKER / 29 (con't)</b>					
LARK			1966	001	9536
CRUISER			1966		9542
HAWK			1966		9540
GRAN TURISMO			1966		9538

**STUTZ / 29**

OTHER AUTOMOBILE			1998	398	9575
UNKNOWN AUTOMOBILE			1998		9576

**SUBARU / 48**

DL/FE/G/GF/GL/GLF/STD/LOYALE	4 wheel drive, Turbo	1972	1989	031	543
	Loyale	1990	1994		
STAR		1970	1971	032	6720
360		1969	1970	033	6722
LEGACY	Brighton, Outback, Outback II	1989	1998	034	541
XT/XT6	4WD Turbo, convertible, DL	1986	1998	035	546
JUSTY	DL, GL	1987	1994	036	540
SVX		1992	1998	037	545
IMPREZA	Outback, Outback II	1993	1998	038	539
BRAT DL, GL		1978	1998	043	6724
BAJA		2003		044	158148
OUTBACK		2003		045	158150
B9 TRIBECA		2006		402	210288

**SUZUKI / 53**

SA310	GLX	1986	1998	031	6839
SWIFT	GTi, GTX	1989	1998	034	411
ESTEEM		1995	1998	035	405
AERIO		2002		036	147792
FORENZA		2004		037	158152
VERONA		2004		038	158156

Model	Includes	Start	End	SAS Model	ModelID
<b>SUZUKI / 53 (con't)</b>					
RENO		2005		039	174927
SX4		2007		040	233047
SAMURAI	Standard, Deluxe (use 8 stiffness for end impacts, size value for side impacts)	1985	1995	401	406
GRAND VITARA		2003		404	158154
XL7		2003		405	158158
EQUATOR		2009		481	267769

**TOYOTA / 49**

CORONA	Mark II, Custom, 1900, 2000, Deluxe		1982	031	561
COROLLA	1100, 1200, 1600, SR-5, LE, Deluxe, Custom	1969	1985	032	560
	FX-16 (use 9 stiffness for front impacts, size value for side or rear impacts)	1986	1998		
CELICA	GTS	1972	1993	033	556
	1900, 2000, GT, ST	1972	1998		
SUPRA	Celica Supra, Soarer	1979	1998	034	559
CRESSIDA		1978	1992	035	562
CROWN	2300, 2600		1971	036	6746
CARINA	2000	1972	1973	037	6748
TERCEL	Corolla Tercel, 4WD Wagon	1980	1998	038	571
STARLET		1981	1984	039	568
CAMRY	LE, Deluxe, XLE, Coupe	1983	1998	040	555
MR-2		1985	1995	041	564
PASEO		1992	1998	042	565
AVALON		1995	1998	043	554
SOLARA		1999		044	22182
ECHO		2000		045	31612
PRIUS		2001		046	44664
SCION XA		2004		048	158160
SCION XB		2004		049	158162
SCION TC		2005		050	174929



Model	Includes	Start	End	SAS Model	ModelID
<b>TOYOTA / 49 (con't)</b>					
YARIS		2007		051	210292
SCION XD	Code as a 4 door hatchback	2008		052	257690
VENZA		2009		053	269179
4-RUNNER	(use 8 stiffness for end impacts, size value for side impacts)	1985	1998	401	553
RAV-4		1996	1998	402	6750
HIGHLANDER		2001		403	44666
MATRIX		2003		404	45093
FJ CRUISER		2007		405	210290
LANDCRUISER	(use 8 stiffness for end impacts, size value for side impacts)	1976	1998	421	563
SEQUOIA		2001		422	40895
MINVAN/PREVIEW	LE, Cargo (use 7 stiffness for end impacts, size value for side impacts)	1984	1990	441	567
	Previa (use 7 stiffness for end impacts, size value for side impacts)	1991	1998		
SIENNA		1998		442	22184
PICKUP	SR-5, Extra Cab, Sport, LN44, Chinook, Wonder Wagon (use 8 stiffness for end impacts, size value for side impacts)	1974	1998	471	566
T-100	(use 8 stiffness for end impacts, size value for side impacts)	1993	1998	481	570
TUNDRA		1999		482	31615

**TRIUMPH / 50**

SPITFIRE	I, II, III, IV, 1500		1981	031	6754
GT-6	MK3	1967	1973	032	6756
TR4	TR2, TR3, TR4A		1968	033	6758
TR6		1969	1976	034	6760
TR7/8		1975	1981	035	6762
HERALD	Vitesse		1998	036	6764
STAG		1971	1973	037	6766
OTHER AUTOMOBILE	2000, 1200 series		1998	398	572

**UNKNOWN FOREIGN MANUFA**

UNKNOWN MEDIUM/HEAVY TRUCK		1993	1998	899	735
----------------------------	--	------	------	-----	-----

**UNKNOWN MEDIUM/HEAVY TF**

Model	Includes	Start	End	SAS Model	ModelID
<b>UNKNOWN MEDIUM/HEAVY TF</b>					
Unknown medium/heavy truck			1999	899	12908
Unknown bus type			1999	988	12910
<b>VOLKSWAGEN / 30</b>					
KARMANN GHIA			1974	031	6759
BEETLE 1300/1500	flat windshield, 94.5" WB		1977	032	6761
SUPER BEETLE	Distinguished by curved windshield, 95.3" WB	1971	1980	033	5820
411/412	Squareback/Fastback	1971	1974	034	6763
SQUAREBACK/FASTBACK	Type 3, 1600		1974	035	6765
RABBIT	L, GTI, Sport, LS, Custom, DL, Deluxe	1975	1984	036	964
DASHER		1974	1981	037	6767
SCIROCCO	16V	1975	1988	038	965
JETTA	GL, GLI	1981	1992	040	950
QUANTUM	Synco	1982	1988	041	961
GOLF/CABRIOLET/GTI	Synco, GTI, Cabriolet, GT, GL	1985	1992	042	934
RABBIT PICKUP	car/based pickup	1980	1983	043	6769
FOX	GL	1987	1998	044	941
CORRADO		1989	1998	045	937
PASSAT		1990	1998	046	958
JETTA III		1993	1998	047	957
GOLF III		1993	1998	048	946
NEW BEETLE		1998		049	22187
PHAETON		2003		050	158164
EOS		2007		051	210294
THE THING (181)		1973	1975	401	6771
TIGUAN		2008		402	233049
TOUAREG		2003		421	158166
VANAGON/CAMPER	Bus, Kombi, Van (use 7 stiffness for end impacts, size value for side impacts)		1998	441	935
EUROVAN	(use 7 stiffness for end impacts, size value for side impacts)	1992	1998	442	940

Model	Includes	Start	End	SAS Model	ModelID
<b>VOLKSWAGEN / 30 (con't)</b>					
ROUTAN	S, SE, SEL Premium/RSE	2009		443	269695
<b>VOLVO / 51</b>					
122	S		1968	031	6774
142/144/145	S, E, GL, GLS, Deluxe		1974	032	6777
164	S, E	1969	1975	033	6780
240/242/244/245	DL, GL, GLE, GLT, Deluxe	1975	1998	034	583
262/264/265	GL	1976	1982	035	587
1800	E, S, ES		1973	036	6782
760/780	GLE, Turbo	1983	1990	038	596
	GLE, Turbo	1987	1992		
740	GLE, GT, Turbo, GL	1986	1992	039	590
940	GLE, Turbo, SE	1991	1998	040	6784
960		1992	1998	041	6786
850	GLT, Wagon	1993	1998	042	6788
70 SERIES	C70 (LT, HT, T5), S70 (GLT, T5, AWD) V70 (R, SC Cross Country, GLT, T-5, XC-70, M, 2.4T, 2.4, 2.5T, T-6, R, 3.2) LPT, HPT	1998		043	24066
90 SERIES		1998		044	24068
80 SERIES	S80	1999		045	31610
40 SERIES	Includes S40, V40	2000		046	31608
60 SERIES	S60 (2.4T, 2.4, 2.5 AWD, T5), 2.4M, 2.5T, R, T5, 2.4i, T5, R-Design	2001		047	44667
V50		2005		048	174931
C30	1.0, 2.0, T5, R-Design	2008		049	268607
XC60		2008		050	277705
XC90		2003		401	148083
<b>YUGO / 57</b>					
GV	GVX, Cabriolet	1986	1992	031	7890

**APPENDIX B**

**STIFFNESS VALUES**

**Table 1: Vehicle Size Categories for Automobiles, Pickups and SUVs**

Category No.	Wheelbase Size (cm)
1	1 - 240
2	241 - 258
3	259 - 280
4	281 - 298
5	299 - 313
6	> 313
7	All Vans

**Table 2: Vehicle Stiffness Categories**

Body Type Category <sup>1</sup>	Stiffness Category		
	Front	Rear	Side
Automobiles, Automobile Derivatives	Wheelbase size <sup>2</sup>	Wheelbase size <sup>2</sup>	Wheelbase size <sup>2</sup>
Utility Vehicles (SUV's) (≤4,536 kgs GVWR)	7	7	Wheelbase size <sup>2</sup>
Vans (≤4,536 kgs GVWR)	7	7	Wheelbase size <sup>2</sup>
Light Conventional Trucks Pickup style cab, ≤4,536 kgs GVWR)	8	8	Wheelbase size <sup>2</sup>

**Notes:**

1. Body Category is selected on General Vehicle Form, Vehicle Tab.
2. Select category 1 to 6 based on wheelbase size from Table 1.

**APPENDIX C**

**MAKE MODEL  
CHILD RESTRAINTS**

<u>TYPE</u>	<u>MAKE</u>	<u>MODEL</u>	<u>SAS</u>
BSS	Baby Trend	Recaro	343
BSS	Baby Trend	Trend	344
ISS	Baby Trend	EZ Loc	149
ISS	Baby Trend	Flex Loc	142
ISS	Baby Trend	Latch Loc	150
ISS	Baby Trend	Tahoe	130
CSS	Babyhood	Baby Sitter, Wonda Chair	249
BSS	Basic Comfort	Booster	548
BSS	Basic Comfort	Galaxy 2000	636
BSS	Britax	Bodyguard	836
BSS	Britax	Cruiser	640
BSS	Britax	Monarch	350
BSS	Britax	Parkway	331
BSS	Britax	Roadster	531
BSS	Britax	Stariser / Comfy	530
BSS/FSS	Britax	Frontier	359
CSS	Britax	Advantage	702
CSS	Britax	Advocate CS	287
CSS	Britax	Boulevard	265
CSS	Britax	Decathlon	266
CSS	Britax	Diplomat	281
CSS	Britax	Elite	677
CSS	Britax	Galaxy	267
CSS	Britax	Marathon	812
CSS	Britax	Roundabout	637
CSS	Britax	Wizard	845
FSS	Britax	Expressway	706
FSS	Britax	Freeway, Plus	701
FSS	Britax	Husky	811
FSS	Britax	Laptop	815
FSS	Britax	Regent	705
FSS	Britax	Traveller Plus	700
ISS	Britax	Baby Safe	131
ISS	Britax	Baby Trend Latch-Loc	133
ISS	Britax	Companion	132
ISS	Britax	Handle With Care	639
ISS	Britax	Rock -a- tot	641
INT	Buick	Century Integrated Seat	950
INT	Buick	Regal Integrated Seat	950
ISS	Buick	Baby Safe	129
BSS	Car Seat Specialty	Duo Highback Booster	520
BSS	Car Seat Specialty	Nania Ola	329
BSS	Car Seat Specialty	Speedway Booster	522
BSS	Car Seat Specialty	Topper Highback/LoBack	532
BSS	Car Seat Specialty	Uno/Polo	704
BSS/FSS	Car Seat Specialty	Airway	830
BSS/FSS	Car Seat Specialty	Nania Nuevo	851
BSS/FSS	Car Seat Specialty	Nania Solo	850

<u>TYPE</u>	<u>MAKE</u>	<u>MODEL</u>	<u>SAS</u>
CSS	Car Seat Specialty	Nania Basic	269
CSS	Car Seat Specialty	Nania Convertible	268
CSS	Car Seat Specialty	Safety Basic Convertible	521
FSS	Car Seat Specialty	Speedway Car Seat	526
ISS	Car Seat Specialty	Nania Baby One	123
BSS	Century Products	Breverra Contour Sport	519
BSS/FSS	Century Products	8480 Booster	634
BSS/FSS	Century Products	Breverra	599
BSS/FSS	Century Products	Breverra Ascend, Sport	516
BSS/FSS	Century Products	Breverra Classic	774
BSS/FSS	Century Products	Breverra Contour	600
BSS/FSS	Century Products	Breverra Contour SE	601
BSS/FSS	Century Products	Breverra Metro	517
BSS/FSS	Century Products	Breverra Premier	518
BSS/FSS	Century Products	Breverra Transit	792
BSS/FSS	Century Products	CR3	598
BSS/FSS	Century Products	Next Step	776
BSS/FSS	Century Products	Safe-T-Rider	801
CSS	Century Products	1000 STE	205
CSS	Century Products	1500 STE	635
CSS	Century Products	2000 STE	206
CSS	Century Products	3000 STE, 3500 STE	207
CSS	Century Products	4100	710
CSS	Century Products	4200	630
CSS	Century Products	4300	631
CSS	Century Products	4400	632
CSS	Century Products	5000 STE, 5500 STE	250
CSS	Century Products	Accel	534
CSS	Century Products	Bravo	596
CSS	Century Products	Nexus	597
CSS	Century Products	Ovation	594
CSS	Century Products	Ovation Encore	684
CSS	Century Products	Ovation Select Fit	595
CSS	Century Products	Room To Grow	592
CSS	Century Products	Smart Move	681
CSS	Century Products	Smart Move XT, SE	533
FSS	Century Products	4600	709
FSS	Century Products	Commander	301
ISS	Century Products	4-in-1 Travel Solutions	591
ISS	Century Products	4500	633
ISS	Century Products	Advanta	513
ISS	Century Products	Assura	514
ISS	Century Products	Assura Premiere	771
ISS	Century Products	Assura V	515
ISS	Century Products	Avanta SE	772
ISS	Century Products	Infant 560, 565, 570	565
ISS	Century Products	Infant 580, 590	569
ISS	Century Products	Infant Love Seat	567
ISS	Century Products	Smart Fit	593



<u>TYPE</u>	<u>MAKE</u>	<u>MODEL</u>	<u>SAS</u>
ISS	Century Products	Smart Fit Plus, Elite	625
ISS	Century Products	Smart Fit Supreme	623
BSS/FSS	Century/Graco	Simpson	397
CSS	Century/Graco	Encore	686
ISS	Century/Graco	530	602
ISS	Century/Graco	560	536
ISS	Century/Graco	Avanta	537
ISS	Century/Graco	Celestia	562
ISS	Century/Graco	Travel System	140
ISS	Century/Graco	Vante V	804
ISS	Century/Graco	Vante V	814
INT	Chevrolet	Astro Integrated Seat	950
INT	Chevrolet	Geo Prizm Integrated Seat	950
INT	Chevrolet	Lumina Integrated Seat	950
INT	Chevrolet	Venture Integrated Seat	950
FSS	Chicco	Shuttle	685
ISS	Chicco	KeyFit	848
INT	Chrysler	Cirrus Integrated Seat	950
INT	Chrysler	Concorde Integrated Seat	950
INT	Chrysler	Town & Country SX, LX Integrated Seat	950
CSS	Collier-Keyworth	Formula 1	547
CSS	Collier-Keyworth	Roundtripper	210
CSS	Collier-Keyworth	Safe & Sound II	209
FSS	Collier-Keyworth	Co-Pilot	303
ISS	Collier-Keyworth	Cuddle Shuttle	104
SNSS	Columbia Medical	2000	703
BSS	Combi	Apogee	342
BSS	Combi	Dakota	348
BSS	Combi	Everest	347
BSS	Combi	Kobuk	349
BSS	Combi	Yorktown	345
CSS	Combi	Avatar	271
CSS	Combi	Victoria	270
ISS	Combi	Centre	138
ISS	Combi	Connection	136
ISS	Combi	Shuttle	144
ISS	Combi	Tyro	134
BSS	Compass	B500 Folding Booster	346
BSS/FSS	Compass	Apex	857
BSS	Cosco/Dorel	Ambassador	325
BSS	Cosco/Dorel	Complete Voyager	725
BSS	Cosco/Dorel	Eddie Bauer Auto Booster	364
BSS	Cosco/Dorel	Highrise	328
BSS	Cosco/Dorel	Pronto	362
BSS	Cosco/Dorel	Protek	323
BSS	Cosco/Dorel	Select Ride	357
BSS	Cosco/Dorel	Traveler	332
BSS	Cosco/Dorel	Valet	333
BSS	Cosco/Dorel	Vista	800

<u>TYPE</u>	<u>MAKE</u>	<u>MODEL</u>	<u>SAS</u>
BSS	Cosco/Dorel	Voyager	585
BSS/CSS	Cosco/Dorel	Alpha Omega	551
BSS/CSS	Cosco/Dorel	Alpha Omega Elite	506
BSS/CSS	Cosco/Dorel	Eddie Bauer 02-537	718
BSS/CSS	Cosco/Dorel	Eddie Bauer Deluxe 3-in-1	326
BSS/CSS	Cosco/Dorel	Eddie Bauer Deluxe Convertible	500
BSS/CSS	Cosco/Dorel	Enspira	502
BSS/CSS	Cosco/Dorel	Intera	503
BSS/FSS	Cosco/Dorel	Adventurer II	535
BSS/FSS	Cosco/Dorel	Commuter High Back Booster	324
BSS/FSS	Cosco/Dorel	Eddie Bauer 02-429,	679
BSS/FSS	Cosco/Dorel	Eddie Bauer 02-849, 02-880, 22-854	668
BSS/FSS	Cosco/Dorel	Eddie Bauer High Back Booster	864
BSS/FSS	Cosco/Dorel	Explorer	672
BSS/FSS	Cosco/Dorel	Grand Explorer	674
BSS/FSS	Cosco/Dorel	High Back Booster	550
BSS/FSS	Cosco/Dorel	Summit	797
BSS/FSS	Cosco/Dorel	Vantage Point	852
BSS/FSS	Cosco/Dorel	Ventura/Vision	586
CSS	Cosco/Dorel	5 PT	215
CSS	Cosco/Dorel	Alpha Luxe Echelon	284
CSS	Cosco/Dorel	Auto Trac	553
CSS	Cosco/Dorel	Comfort Ride	751
CSS	Cosco/Dorel	Commuter	554
CSS	Cosco/Dorel	Cosco Safe & Easy	213
CSS	Cosco/Dorel	Cosco Safe & Snug	214
CSS	Cosco/Dorel	Eddie Bauer	278
CSS	Cosco/Dorel	Eddie Bauer 02-870	669
CSS	Cosco/Dorel	Eddie Bauer 02-875	670
CSS	Cosco/Dorel	Olympian	576
CSS	Cosco/Dorel	Regal Ride	578
CSS	Cosco/Dorel	Scenera	272
CSS	Cosco/Dorel	Soft Shield	579
CSS	Cosco/Dorel	Touriva	581
CSS	Cosco/Dorel	Triad	582
FSS	Cosco/Dorel	Maxi-Cosi Priori	615
ISS	Cosco/Dorel	Arriva	552
ISS	Cosco/Dorel	Cosco TLC	105
ISS	Cosco/Dorel	Designer 22	726
ISS	Cosco/Dorel	Designer 35	727
ISS	Cosco/Dorel	Dream Ride	728
ISS	Cosco/Dorel	Eddie Bauer 02-770	719
ISS	Cosco/Dorel	Eddie Bauer Comfort	124
ISS	Cosco/Dorel	Eddie Bauer Deluxe Infant Car Seat	148
ISS	Cosco/Dorel	Eddie Bauer Infant Car Seat	146
ISS	Cosco/Dorel	Eddie Bauer Integrated Travel System	135
ISS	Cosco/Dorel	Eddie Bauer SureFit	143
ISS	Cosco/Dorel	First Ride	673
ISS	Cosco/Dorel	Infant Car Seat	675

<u>TYPE</u>	<u>MAKE</u>	<u>MODEL</u>	<u>SAS</u>
ISS	Cosco/Dorel	LatchLoc	846
ISS	Cosco/Dorel	Opus 35	577
ISS	Cosco/Dorel	TLC	580
ISS	Cosco/Dorel	Turnbout	583
ISS	Cosco/Dorel	Ultra Dream Ride	584
VSS	Cosco/Dorel	Travel Vest	720
BSS	Cosco/Peterson	Traver Hi-Lo	671
CSS	Cosco/Peterson	Safe & Easy	764
CSS	Cosco/Peterson	Safe & Snug	765
CSS	Cosco/Peterson	Safe-T-Seat	217
CSS	Cosco/Peterson	Safe-T-Shield	218
FSS	Cosco/Peterson	Travel Hi-Lo - Includes Deluxe High Back	305
INT	Dodge	Caravan	
INT	Dodge	Caravan Integrated Seat	950
INT	Dodge	Grand Caravan Integrated Seat	950
INT	Dodge	Integrated	
INT	Dodge	Intrepid Integrated Seat	950
INT	Dodge	Neon Integrated Seat	950
INT	Dodge	Stratus Integrated Seat	950
ISS	Dodge	Flex Loc	122
BSS	Downunder	Kangaroo	770
CSS	Early Development	Guardian Comfort	667
CSS	Early Development	Guardian Express	773
CSS	Early Development	Guardian Folder	775
BSS	Evenflo	Big Kid	330
BSS	Evenflo	Booster Seat	624
BSS	Evenflo	Confidence	355
BSS	Evenflo	Right Fit	656
BSS	Evenflo	Secure Comfort	661
BSS	Evenflo	Sightseer Comfort Touch	834
BSS/CSS	Evenflo	Seven Year	605
BSS/CSS	Evenflo	Symphony	288
BSS/FSS	Evenflo	Apollo	813
BSS/FSS	Evenflo	Bolero	866
BSS/FSS	Evenflo	Chase Comfort Touch	798
BSS/FSS	Evenflo	Chase DLX	862
BSS/FSS	Evenflo	Comet	835
BSS/FSS	Evenflo	Express	545
BSS/FSS	Evenflo	Generations	860
BSS/FSS	Evenflo	Sidekick	606
BSS/FSS	Evenflo	Traditions	853
BSS/FSS	Evenflo	Two-in-One	609
BSS/FSS	Evenflo	Vision	264
CSS	Evenflo	7 Year	616
CSS	Evenflo	Bobby Mac	223
CSS	Evenflo	Bobby-Mac Champion	620
CSS	Evenflo	Bobby-Mac Super	622
CSS	Evenflo	Champion	626
CSS	Evenflo	Conquest I	627

<u>TYPE</u>	<u>MAKE</u>	<u>MODEL</u>	<u>SAS</u>
CSS	Evenflo	Conquest V	628
CSS	Evenflo	Horizon	707
CSS	Evenflo	Horizon I	524
CSS	Evenflo	Horizon V	525
CSS	Evenflo	Medallion	510
CSS	Evenflo	Medallion V	527
CSS	Evenflo	My Style	273
CSS	Evenflo	Odyssey I	643
CSS	Evenflo	Odyssey V	646
CSS	Evenflo	One Step	655
CSS	Evenflo	Orion	
CSS	Evenflo	Scout	657
CSS	Evenflo	Secure Advantage I	658
CSS	Evenflo	Secure Advantage V	659
CSS	Evenflo	Secure Choice	660
CSS	Evenflo	Titan	793
CSS	Evenflo	Titan 5	816
CSS	Evenflo	Town & Country	607
CSS	Evenflo	Tribute	817
CSS	Evenflo	Tribute 5	818
CSS	Evenflo	Triumph	799
CSS	Evenflo	Trooper	608
CSS	Evenflo	Ultara I	610
CSS	Evenflo	Ultara II	611
CSS	Evenflo	Ultara Premier	612
CSS	Evenflo	Ultara Premier V	613
CSS	Evenflo	Ultara V	614
CSS	Evenflo	Vanguard 1 Comfort Touch	833
CSS	Evenflo	Vanguard 5	809
CSS	Evenflo	Victory 5	808
FSS	Evenflo	Bobby-Mac Lite	621
FSS	Evenflo	Booster	306
FSS	Evenflo	Sightseer	319
FSS	Evenflo	Wings	307
HSS	Evenflo	Harness	724
ISS	Evenflo	Cozy Carry	794
ISS	Evenflo	Discovery	629
ISS	Evenflo	Dyn-O-Mite	109
ISS	Evenflo	Embrace	847
ISS	Evenflo	First Choice	546
ISS	Evenflo	Infant Seat 456	508
ISS	Evenflo	Joy Ride	115
ISS	Evenflo	On My Way	649
ISS	Evenflo	On My Way, Position Right	654
ISS	Evenflo	Port About	805
ISS	Evenflo	Port About 3	832
ISS	Evenflo	Port About 5, Comfort Touch, Premier	831
ISS	Evenflo	Tot Taxi	806
ISS	Evenflo	Travel Tandem	117

<u>TYPE</u>	<u>MAKE</u>	<u>MODEL</u>	<u>SAS</u>
VSS	Evenflo	Vest	248
Unknown	E-Z On Products	E-Z-On Vest - Includes 101-TCXS, 101-TC, 102-TC(8 sizes)	403
CSS	FBS, Inc. Renolux	GT-2000	549
CSS	FBS, Inc. Renolux	GT-5000 Turn-A-Tot	574
CSS	FBS, Inc. Renolux	GT-7000	575
BSS	Fisher-Price	Safe Embrace Booster	828
BSS	Fisher-Price	Safe Voyage Booster	352
BSS/CSS	Fisher-Price	Safe Embrace	587
BSS/FSS	Fisher-Price	Grow with me	662
BSS/FSS	Fisher-Price	T-Shield Booster	590
CSS	Fisher-Price	9100, 9101	555
CSS	Fisher-Price	Bolster	556
CSS	Fisher-Price	Comfort Plus	557
CSS	Fisher-Price	Deluxe	558
CSS	Fisher-Price	Safe Voyage Convertible	279
FSS	Fisher-Price	Futura 20/60	559
ISS	Fisher-Price	Infant Seat	663
ISS	Fisher-Price	Infant Seat 9149, 9173	664
ISS	Fisher-Price	Safe Embrace Infant Seat	588
ISS	Fisher-Price	Stay in View	589
FSS	Ford	Tot Guard	308
INT	Ford	Escort Integrated Seat	950
INT	Ford	Explorer Integrated Seat	950
INT	Ford	Taurus Integrated Seat	950
INT	Ford	Windstar Integrated Seat	950
BSS	Gerry	Belt Right	761
BSS	Gerry	Pro-Ride	785
BSS	Gerry	Super Shield	618
BSS	Gerry	Voyager	619
BSS/FSS	Gerry	Double Guard	762
BSS/FSS	Gerry	Evolution	777
CSS	Gerry	Guardian	781
CSS	Gerry	One Click	784
CSS	Gerry	Pro-Tech	787
CSS	Gerry	ReadyLock	789
CSS	Gerry	SecureLock	617
ISS	Gerry	Guard with Glide	779
ISS	Gerry	Secure Ride	791
INT	GMC	Safari Integrated Seat	950
BSS	Graco	AirBooster	353
BSS	Graco	My CarGo	334
BSS	Graco	TurboBooster	802
BSS/FSS	Graco	CarGo	859
BSS/FSS	Graco	Cherished CarGo	730
BSS/FSS	Graco	Grand Cargo	822
BSS/FSS	Graco	Nautilus	865
BSS/FSS	Graco	Platinum CarGo	854
BSS/FSS	Graco	Quest	737
BSS/FSS	Graco	Teasured Cargo	824

<u>TYPE</u>	<u>MAKE</u>	<u>MODEL</u>	<u>SAS</u>
BSS/FSS	Graco	Ultra Cargo	829
CSS	Graco	ComfortSport	795
CSS	Graco	GT1000	228
CSS	Graco	Little Trav'ler	227
CSS	Graco	Vanguard Comfort Touch	810
FSS	Graco	Safe Seat Step 2	861
ISS	Graco	Aspen	139
ISS	Graco	Cherish Car Bed	729
ISS	Graco	CoachRider Travel System	840
ISS	Graco	DuoGlider Travel System	841
ISS	Graco	Infant Car Bed	733
ISS	Graco	Infant Safe Seat	145
ISS	Graco	Infant Seat/Carrier	735
ISS	Graco	LiteRider	837
ISS	Graco	LiteRider Breeze	844
ISS	Graco	LiteRider Glider	843
ISS	Graco	LiteRider Sterling	842
ISS	Graco	MetroLite Travel System	839
ISS	Graco	Safe Seat Step 1	141
ISS	Graco	Snug Ride	749
ISS	Graco	Snug Ride DX5	750
ISS	Graco	Snug Seat	111
BSS	Guardian	Double Up	758
CSS	Guardian	Comfort Plus	757
CSS	Guardian	Folder Plus	682
BSS	IMMI	Komfort Kruiser	827
FSS	IMMI	SafeGuard	711
BSS	International	Teddy Tot Astrorider 6000 Series	310
CSS	International	Teddy Tot Astrorider	760
BSS	Jane	Indy Plus	363
INT	Jeep	Grand Cherokee Integrated Seat	950
HSS	Joey Safe	Safety Harness	807
BSS	Jupiter	Grand Touring	722
BSS	Jupiter	Komfort Rider	723
BSS	Jupiter	Komfort Rider GT	604
INT	Kia	Sephia Integrated Seat	950
BSS	Kolcraft	Prodigy	790
BSS	Kolcraft	Tot Rider	734
BSS/FSS	Kolcraft	Flip'n Go	780
CSS	Kolcraft	Auto-Mate - Includes Dial-A-Fit	252
CSS	Kolcraft	Dial-A-Fit	778
CSS	Kolcraft	Hi-Rider XL2	782
CSS	Kolcraft	Perfect F.I.T.	247
CSS	Kolcraft	Performa	788
CSS	Kolcraft	Playskool	253
CSS	Kolcraft	Quickstep	232
CSS	Kolcraft	Redi-Rider	231
CSS	Kolcraft	Secure Fit	732
CSS	Kolcraft	Traveler 700	260

<u>TYPE</u>	<u>MAKE</u>	<u>MODEL</u>	<u>SAS</u>
CSS	Kolcraft	Ultra Ride	233
FSS	Kolcraft	Tot Rider Quick Step	838
ISS	Kolcraft	Infant Car Seat	783
ISS	Kolcraft	Infant Rider	786
ISS	Kolcraft	Rock 'n Ride	112
ISS	Kolcraft	Secura	731
ISS	Kolcraft	Travel About	736
BSS	LaRoche	Grizzly Bear	738
BSS	LaRoche	Polar Bear	335
BSS	LaRoche	Teddy Bear	739
CSS	Lennox	Tattle Tale	275
VSS	Little Cargo	Travel Vest	740
BSS	Magna	Clek Olli	354
BSS	Magna	Clek Oobr	360
BSS	Magna	Clek Ozzi	361
CSS	Maxi-Cosi	Priori	283
ISS	Maxi-Cosi	Mico	147
BSS	Mercedes Benz	Booster Seat	690
FSS	Mercedes Benz	Toddler Seat	680
ISS	Mercedes Benz	Baby Smart	741
INT	Mercury	Mountaineer Integrated Seat	950
INT	Mercury	Sable Integrated Seat	950
INT	Mercury	Tracer Integrated Seat	950
INT	Mercury	Villager Integrated Seat	950
BSS	Nania	HighRide	358
CSS	Nissan	Child Safety Seat	746
CSS	Nissan	Infant-Child Safety Seat	234
INT	Nissan	Quest Integrated Seat	950
INT	Oldsmobile	Silhouette Integrated Seat	950
ISS	Peg Perego	Primo Viaggio	796
ISS	Pioneered II	Safety System Infant Car Seat	125
INT	Plymouth	Breeze Integrated Seat	950
INT	Plymouth	Grand Voyager Integrated Seat	950
INT	Pontiac	Grand Prix Integrated Seat	950
INT	Pontiac	Montana Integrated Seat	950
INT	Pontiac	Trans Sport Integrated Seat	950
BSS	Porsche	Comfy	651
BSS	Porsche	Zoom	653
CSS	Porsche	Convertible	678
FSS	Porsche	Prince	652
ISS	Porsche	Baby-Safe	650
CSS	Pride-Trimble	Pride-Ride 820 & 830 Series	235
CSS	Prodigy	Kiwi Plus	254
CSS	Prodigy	Shuttle	255
CSS	Questor/Kantwet	Care Seat	236
CSS	Questor/Kantwet	One Step	752
FSS	Questor/Kantwet	Safe Guard	237
BSS	Recaro	Start	665
BSS	Recaro	Vivo	356

<u>TYPE</u>	<u>MAKE</u>	<u>MODEL</u>	<u>SAS</u>
BSS/FSS	Recaro	Young Sport	867
CSS	Recaro	Como	282
CSS	Recaro	Signo	
BSS	Renolux	Booster	666
CSS	Renolux	GT 4000	714
CSS	Renolux	GT 7000	715
CSS	Renolux	Renolux GT 2000	256
CSS	Renolux	Turn-A-Tot GT 5000	753
INT	Saab	9-3 Integrated Seat	950
INT	Saab	9-5 Integrated Seat	950
BSS/FSS	Safeguard	Go	868
FSS	Safeguard	Child Seat	870
BSS	Safeline	Mission Control	573
BSS	Safeline	Pilot	695
CSS	Safeline	Sit n' Stroll	696
FSS	Safe-n-Sound	Series 3	712
ISS	Safe-n-Sound	Capsule	126
ISS	Safe-n-Sound	Unity	137
BSS	Safety 1st	Highrider	336
BSS/CSS	Safety 1st	All-in-One	285
BSS/CSS	Safety 1st	Alpha Sport 3 Phase	507
BSS/CSS	Safety 1st	Enspira	505
BSS/CSS	Safety 1st	Intera	504
BSS/FSS	Safety 1st	Apex 65	863
BSS/FSS	Safety 1st	Prospect	856
BSS/FSS	Safety 1st	Summit Deluxe	869
BSS/FSS	Safety 1st	Surveyor	855
BSS/FSS	Safety 1st	Vantage Point	819
CSS	Safety 1st	Comfort Ride	274
CSS	Safety 1st	Complete Air with Air Protect	286
CSS	Safety 1st	Forerunner	820
CSS	Safety 1st	Uptown	280
ISS	Safety 1st	Designer 22	821
ISS	Safety 1st	Starter	127
VSS	Safety 1st	Tote 'n Go	900
BSS	Safety Angel	Ride Ryte	337
VSS	Safety Angel	Travel Vest	803
BSS/FSS	Safety Baby	Speedway	826
FSS	Safety Baby	Airway	825
SNSS	Safety Rehab	900 Series Transporter	412
SNSS	Sammons Preston	Tumbleforms Carrie	698
CSS	Snug Seat	Spelcast	528
FSS	Snug Seat	Gorilla	511
FSS	Snug Seat	Snug Seat 1	411
FSS	Snug Seat	Snug Seat 2	688
ISS	Snug Seat	Snug Seat Car Bed	512
BSS	Strolee	Highride	339
BSS	Strolee	McKinley	340
BSS	Strolee	Saratoga	338



<u>TYPE</u>	<u>MAKE</u>	<u>MODEL</u>	<u>SAS</u>
BSS	Strolee	Yorktown 8600	341
BSS/FSS	Strolee	Airway Kansas	858
BSS/FSS	Strolee	Wee Care Booster	509
CSS	Strolee	597	708
CSS	Strolee	599	523
CSS	Strolee	Wee Care 600 Series	241
FSS	Strolee	Quick Click	243
ISS	Strolee	Baby One	128
INT	Subaru	Legacy Integrated Seat	950
CSS	Sunshine Kids	Radian	276
BSS	Team Tex	Polo Uno	327
INT	Toyota	Camry Integrated Seat	950
INT	Toyota	Corolla Integrated Seat	950
INT	Toyota	Sienna Integrated Seat	950
FSS	Travel Safety	Inflatable Car Seat	691
CSS	Tripleplay Products	Sit n' Stroll	277
FSS	Tumble Forms	Carrie Car Seat	404
Unknown	Unknown Make	Unknown Model	998
BSS	Volvo	Booster Cushion	692
BSS	Volvo	Child Cushion	245
CSS	Volvo	240, 260	539
INT	Volvo	S40 Integrated Seat	950
INT	Volvo	S70/V70 Integrated Seat	950
INT	Volvo	S80 Integrated Seat	950
INT	Volvo	V40 Integrated Seat	950
INT	Volvo	V70 Integrated Seat	950
CSS	Welsh	Travel Tot	246
FSS	ZB Sales	Bobob	538

**Table A-15 Intruding Component by Injury Source**

<b><i>INTRUDING COMPONENT</i></b>	<b><i>INJURY SOURCE</i></b>
1 Steering assembly	4 Steering wheel rim 5 Steering wheel hub/spoke 6 Steering wheel combination of codes 004 and 005) 7 Steering column, transmission selector lever, other attachment 15 Windshield including one or more of the following: front header, A A1/A2)-pillar, instrument panel, mirror, or steering assembly driver side only) 401 Hand controls for braking/acceleration 402 Steering control devices (attached to OEM steering wheel) 403 Steering knob attached to steering wheel 405 Replacement steering wheel ( <i>i.e.</i> , reduced diameter) 406 Joy stick steering controls 407 Wheelchair tie-downs 408 Modification to seat belts,(specify): 409 Additional or relocated switches, (specify): 412 Other adaptive device (specify):
2 Instrument panel left	8 Cellular telephone or CB radio 9 Add on equipment <i>e.g.</i> , tape deck, air conditioner) 21 Left instrument panel 24 Left lower instrument panel (includes knee bolster) 15 Windshield including one or more of the following: front header, A A1/A2)-pillar, instrument panel, mirror, or steering assembly driver side only) 253 Parking brake handle 401 Hand controls for braking/acceleration 409 Additional or relocated switches, (specify): 412 Other adaptive device (specify):
3 Instrument panel center	8 Cellular telephone or CB radio 9 Add on equipment <i>e.g.</i> , tape deck, air conditioner) 22 Center instrument panel 25 Center lower instrument panel (includes knee bolster) 401 Hand controls for braking/acceleration 412 Other adaptive device (specify): 409 Additional or relocated switches, (specify):
4 Instrument panel right	8 Cellular telephone or CB radio 9 Add on equipment <i>e.g.</i> , tape deck, air conditioner) 13 Glove compartment door 23 Right instrument panel 26 Right lower instrument panel (includes knee bolster) 16 Windshield including one or more of the following: front header, A A1/A2)-pillar,

**Table A-15 Intruding Component by Injury Source**

5 Toe pan	254 Foot controls including parking brake 251 Floor (including toe pan)
6 A (A1/A2)-pillar	15 Windshield including one or more of the following: front header, A A1/A2)-pillar, instrument panel, mirror, or steering assembly driver side only) 16 Windshield including one or more of the following: front header, A A1/A2)-pillar, instrument panel, or mirror (passenger side only) 53 Left A (A1/A2)-pillar 59 Left side window glass including one or more of the following: frame, window sill, A (A1/A2)-pillar, B-pillar, or roof side rail. 103 Right A (A1/A2)-pillar 109 Right side window glass including one or more of the following: frame, window sill, A (A1/A2)-pillar, B-pillar, or roof side rail. 407 Wheelchair tie-downs 411 Wall mounted head rest (used behind wheel chair) 412 Other adaptive device (specify):
7 B-pillar	54 Left B-pillar 59 Left side window glass including one or more of the following: frame, window sill, A (A1/A2)-pillar, B-pillar, or roof side rail. 104 Right B-pillar 109 Right side window glass including one or more of the following: frame, window sill, A (A1/A2)-pillar, B-pillar, or roof side rail. 153 Belt restraint B-pillar or door frame attachment point 407 Wheelchair tie-downs 411 Wall mounted head rest (used behind wheel chair) 412 Other adaptive device (specify):
8 C-pillar	55 Other left pillar (specify): 105 Other right pillar (specify): 407 Wheelchair tie-downs 411 Wall mounted head rest (used behind wheel chair) 412 Other adaptive device (specify):
9 D-pillar	55 Other left pillar (specify): 105 Other right pillar (specify): 407 Wheelchair tie-downs 412 Other adaptive device (specify): 411 Wall mounted head rest (used behind wheel chair)
10 Side panel - forward of the A1/A2-pillar	62 Left side panel forward A1/A2 pillar 112 Right side panel forward A1/A2 pillar

**Table A-15 Intruding Component by Injury Source**

<p>51 Door forward upper quadrant</p>	<p>58 Left side window sill                      59 Left side window glass including one or more of the following: frame, window sill, A (A1/A2)-pillar, B-pillar, or roof side rail.                      73 Left door panel forward upper quadrant                      74 Left door panel forward lower quadrant                      75 Left door panel rear upper quadrant                      76 Left door panel rear lower quadrant                      77 Left hardware/armrest forward upper quadrant                      78 Left hardware/armrest forward lower quadrant                      79 Left hardware/armrest rear upper quadrant                      80 Left hardware/armrest rear lower quadrant                      108 Right side window sill                      109 Right side window glass including one or more of the following: frame, window sill, A (A1/A2)-pillar, B-pillar, or roof side rail                      121 Right door panel forward upper quadrant                      122 Right door panel forward lower quadrant                      123 Right door panel rear upper quadrant                      124 Right door panel rear lower quadrant                      125 Right hardware/armrest forward upper quadrant                      126 Right hardware/armrest forward lower quadrant                      127 Right hardware/armrest rear upper quadrant                      128 Right hardware/armrest rear lower quadrant</p>
<p>52 Door forward lower quadrant</p>	<p>58 Left side window sill                      59 Left side window glass including one or more of the following: frame, window sill, A (A1/A2)-pillar, B-pillar, or roof side rail.                      73 Left door panel forward upper quadrant                      74 Left door panel forward lower quadrant                      75 Left door panel rear upper quadrant                      76 Left door panel rear lower quadrant                      77 Left hardware/armrest forward upper quadrant                      78 Left hardware/armrest forward lower quadrant                      79 Left hardware/armrest rear upper quadrant                      80 Left hardware/armrest rear lower quadrant                      108 Right side window sill                      109 Right side window glass including one or more of the following: frame, window sill, A (A1/A2)-pillar, B-pillar, or roof side rail                      121 Right door panel forward upper quadrant                      122 Right door panel forward lower quadrant                      123 Right door panel rear upper quadrant                      124 Right door panel rear lower quadrant                      125 Right hardware/armrest forward upper quadrant                      126 Right hardware/armrest forward lower quadrant                      127 Right hardware/armrest rear upper quadrant                      128 Right hardware/armrest rear lower quadrant</p>

**Table A-15 Intruding Component by Injury Source**

<p>53 Door rear upper quadrant</p>	<p>58 Left side window sill                      59 Left side window glass including one or more of the following: frame, window sill, A (A1/A2)-pillar, B-pillar, or roof side rail.                      73 Left door panel forward upper quadrant                      74 Left door panel forward lower quadrant                      75 Left door panel rear upper quadrant                      76 Left door panel rear lower quadrant                      77 Left hardware/armrest forward upper quadrant                      78 Left hardware/armrest forward lower quadrant                      79 Left hardware/armrest rear upper quadrant                      80 Left hardware/armrest rear lower quadrant                      108 Right side window sill                      109 Right side window glass including one or more of the following: frame, window sill, A (A1/A2)-pillar, B-pillar, or roof side rail                      121 Right door panel forward upper quadrant                      122 Right door panel forward lower quadrant                      123 Right door panel rear upper quadrant                      124 Right door panel rear lower quadrant                      125 Right hardware/armrest forward upper quadrant                      126 Right hardware/armrest forward lower quadrant                      127 Right hardware/armrest rear upper quadrant                      128 Right hardware/armrest rear lower quadrant</p>
<p>54 Door rear lower quadrant</p>	<p>58 Left side window sill                      59 Left side window glass including one or more of the following: frame, window sill, A (A1/A2)-pillar, B-pillar, or roof side rail.                      73 Left door panel forward upper quadrant                      74 Left door panel forward lower quadrant                      75 Left door panel rear upper quadrant                      76 Left door panel rear lower quadrant                      77 Left hardware/armrest forward upper quadrant                      78 Left hardware/armrest forward lower quadrant                      79 Left hardware/armrest rear upper quadrant                      80 Left hardware/armrest rear lower quadrant                      108 Right side window sill                      109 Right side window glass including one or more of the following: frame, window sill, A (A1/A2)-pillar, B-pillar, or roof side rail                      121 Right door panel forward upper quadrant                      122 Right door panel forward lower quadrant                      123 Right door panel rear upper quadrant                      124 Right door panel rear lower quadrant                      125 Right hardware/armrest forward upper quadrant                      126 Right hardware/armrest forward lower quadrant                      127 Right hardware/armrest rear upper quadrant                      128 Right hardware/armrest rear lower quadrant</p>

**Table A-15 Intruding Component by Injury Source**

<p>55 Door undetermined quadrant</p>	<p>58 Left side window sill                      59 Left side window glass including one or more of the following: frame, window sill, A (A1/A2)-pillar, B-pillar, or roof side rail.                      73 Left door panel forward upper quadrant                      74 Left door panel forward lower quadrant                      75 Left door panel rear upper quadrant                      76 Left door panel rear lower quadrant                      77 Left hardware/armrest forward upper quadrant                      78 Left hardware/armrest forward lower quadrant                      79 Left hardware/armrest rear upper quadrant                      80 Left hardware/armrest rear lower quadrant                      108 Right side window sill                      109 Right side window glass including one or more of the following: frame, window sill, A (A1/A2)-pillar, B-pillar, or roof side rail                      121 Right door panel forward upper quadrant                      122 Right door panel forward lower quadrant                      123 Right door panel rear upper quadrant                      124 Right door panel rear lower quadrant                      125 Right hardware/armrest forward upper quadrant                      126 Right hardware/armrest forward lower quadrant                      127 Right hardware/armrest rear upper quadrant                      128 Right hardware/armrest rear lower quadrant</p>
<p>12 Side panel - rear of the B-pillar</p>	<p>63 Left side panel rear of the B pillar                      113 Right side panel rear of the B pillar</p>
<p>13 Roof (or convertible top)</p>	<p>205 Roof or convertible top                      410 Raised roof                      206 Roof maplight/console                      207 Sunroof/components                      208 Rollbar</p>
<p>14 Roof side rail</p>	<p>59 Left side window glass including one or more of the following: frame, window sill, A (A1/A2)-pillar, B-pillar, or roof side rail.                      109 Right side window glass including one or more of the following: frame, window sill, A (A1/A2)-pillar, B-pillar, or roof side rail.                      203 Roof left side rail                      204 Roof right side rail</p>
<p>15 Windshield</p>	<p>1 Windshield                      2 Mirror                      15 Windshield including one or more of the following: front header, A A1/A2)-pillar, instrument panel, mirror, or steering assembly driver side only)                      16 Windshield including one or more of the following: front header, A A1/A2)-pillar, instrument panel, or mirror (passenger side only)                      17 Windshield reinforced by exterior object (specify)                      20 Sunvisor reinforced by front header</p>

**Table A-15 Intruding Component by Injury Source**

16 Windshield header	<p>15 Windshield including one or more of the following: front header, A A1/A2)-pillar, instrument panel, mirror, or steering assembly driver side only)</p> <p>16 Windshield including one or more of the following: front header, A A1/A2)-pillar, instrument panel, or mirror (passenger side only)</p> <p>17 Windshield reinforced by exterior object (specify)</p> <p>201 Front header</p> <p>20 Sunvisor reinforced by front header</p>
17 Window frame	<p>56 Left side window glass</p> <p>57 Left side window frame</p> <p>59 Left side window glass including one or more of the following: frame, window sill, A (A1/A2)-pillar, B-pillar, or roof side rail.</p> <p>106 Right side window glass</p> <p>107 Right side window frame</p> <p>109 Right side window glass including one or more of the following: frame, window sill, A (A1/A2)-pillar, B-pillar, or roof side rail.</p>
18 Floor pan (includes sill)	<p>251 Floor (including toe pan)</p> <p>252 Floor or console mounted transmission lever, including console</p>
19 Backlight header	<p>202 Rear header</p> <p>301 Backlight (rear window)</p>
20 Front seat back	<p>151 Seat, back support</p> <p>155 Head restraint system</p> <p>412 Other adaptive device (specify):</p>
21 Second seat back	<p>151 Seat, back support</p> <p>155 Head restraint system</p> <p>412 Other adaptive device (specify):</p>
22 Third seat back	<p>151 Seat, back support</p>
23 Fourth seat back	<p>151 Seat, back support</p>
24 Fifth seat back	<p>151 Seat, back support</p>
25 Seat cushion	<p>151 Seat, back support</p>

**Table A-15 Intruding Component by Injury Source**

26 Back door/panel (e.g., tailgate)	302 Backlight storage rack, door, etc. 303 Other rear object (specify):
27 Other interior component (specify):	19 Other front object (specify): 55 Other left pillar (specify): 60 Other left side object (specify): 105 Other right pillar (specify): 110 Other right side object (specify): 163 Other interior object (specify): 252 Floor or console mounted transmission lever, including console 303 Other rear object (specify): 412 Other adaptive device (specify): 576 Cargo in vehicle 154 Other restraint system component 164 Center console first row 165 Center console second row 166 Center console other row 167 Fold down armrest first row 168 Fold down armrest second row 169 Fold down armrest other row 161 Interior loose objects 572 Seat LATCH points for child restraints 573 Grab handles 574 Engine shroud cover 575 Seatback trays
30 Hood	451 Hood
31 Outside surface of this vehicle (specify):	452 Outside hardware (e.g., outside mirror, antenna) 453 Other exterior surface or tires (specify):
32 Other exterior object in the environment (specify):	598 Other vehicle or object (specify): 501 Front bumper 502 Hood edge 503 Other front of vehicle (specify): 504 Hood 505 Hood ornament 506 Windshield, roof rail, A-pillar 507 Side surface 508 Side mirrors 509 Other side protrusions (specify): 510 Rear surface 511 Undercarriage 512 Tires and wheels 513 Other exterior of other motor vehicle (specify): 552 Tree 553 Pole 554 Traffic barrier 551 Ground



**Table A-15 Intruding Component by Injury Source**

	598 Other object (specify):
33 Unknown exterior object	514 Unknown exterior of other motor vehicle 454 Unknown exterior objects
98 Intrusion of unlisted component(s)	19 Other front object (specify): 60 Other left side object (specify): 110 Other right side object (specify): 163 Other interior object (specify): 195 Other air bag compartment cover (specify): 303 Other rear object (specify): 412 Other adaptive device (specify):

**APPENDIX E**

**UNIFORM SYMBOLS FOR DIAGRAMMING  
AND SCENE MARKING**

## UNIFORM SYMBOLS FOR SCENE MARKING

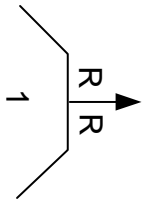

Mark to show beginning of rear skidmarks. Arrow shows direction of travel. Number indicates identity of vehicle involved.

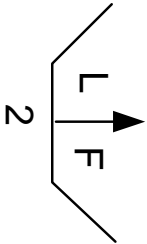

Mark to show beginning of rear skidmarks. Arrow shows direction of travel. Number indicates identity of vehicle involved.

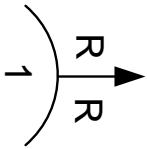

Position of rear wheels at impact. Notes end of post-impact skid.

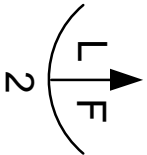

Position of front wheels at impact. Notes end of post-impact skid.



Rear wheel at final position.



Front wheel at final position.

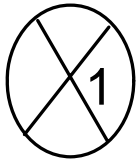

Position of impact point. 1-First Impact/2-Second Impact

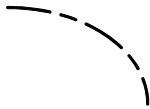

Indicative mark for scratches.



Indicative mark for gouges.



Indicative mark for scuffs.

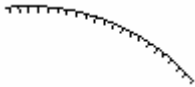

Indicative mark for centripetal curve scuffs.



Indicative mark for rotating tire print.

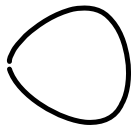

Indicative mark for puddle (liquids).

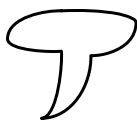

Indicative mark for puddle with run-off. (Initials-**G** for gasoline; **M** for motor oil; **R** for radiator coolant; **T** for transmission oil; **B** for battery acid; **F** for brake fluid; **W** for water and **H** for Blood-to be inserted inside the circles for further identification.

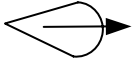

Indicative mark for debris, arrow to show direction of force.



Male body (arrow pointing toward feet).



Female body (cross indicating direction of feet).

# UNIFORM SYMBOLS FOR CRASH DIAGRAMMING

## Vehicle and Pedestrian Symbols



Automobile (pre-impact or at-impact position). Exception: draw **solid** outline if stopped at-impact.



Automobile (final rest position)-showing damaged area.

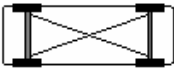

Automobile (final position on its top).

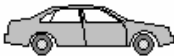

Automobile (final position on its left side, reverse for right side).



Automobile involved in the crash as a temporary environmental factor, but not physically involved in the collision (Noncontact Unit).



Parked automobile not struck (give it a number if it was struck).



Vehicle in which a witness was an occupant.

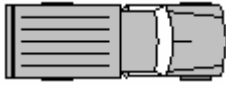

Pick up truck.

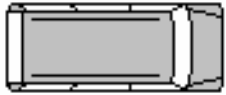

Van



Delivery Van

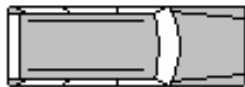

Sport Utility Vehicle



Truck tractor and semi-trailer

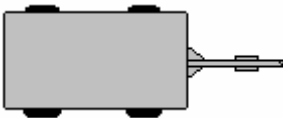

Utility Trailer

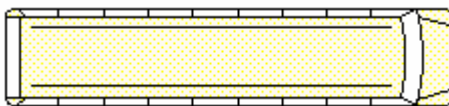

Bus

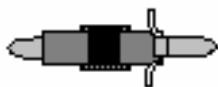

Motorcyclist

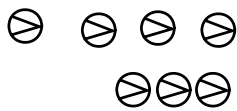

Pedestrian (pointer oriented to show direction of movement and dot spacing to show rate of movement (i.e., 1 meter apart walking and 2 meter apart running)).



Final position of body.



Pedestrian who witnessed crash.

All symbols referring to colliding vehicles (plus Noncontact, Witness and Parked vehicles) are to have a broken outline if they are moving at the point in which they are depicted; the outline should be solid if the vehicle is stopped where depicted, or at final rest. Be careful to insure proper placement (location) or orientation on the diagram.



## Scene Road Marking



Point of Impact

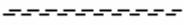

Skidmarks

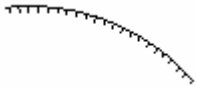

Centripetal curve scuffs



Tire scuff marks



Rotating tire print



Gouges



Scratches



Liquids (puddle and run-off)



Debris

Any other crash-induced markings, components from vehicles, etc. should be shown in their approximate location and a reasonable likeness sketched on the diagram.

## Topographical Highway and Environment Symbols

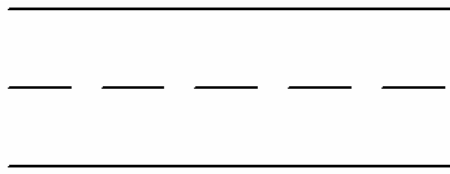

Pavement edge



Shoulder edge line (non-formal)

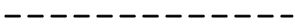

Shoulder edge line (formal)

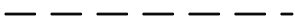

Broken center line or lane lines

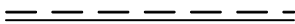

Broken center line with No-Passing line

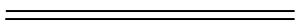

Double yellow center lines



Raised island and Grass Median



Painted median



Curb



Paved shoulders with diagonal lines



Turn arrows



Building or wall



Bridge abutment and railing

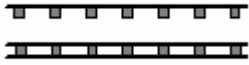

Guardrail



Fence



Railroad tracks

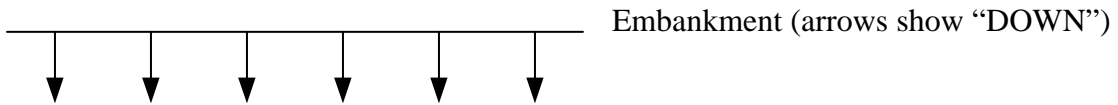

Embankment (arrows show "DOWN")



Shrubbery-hedges

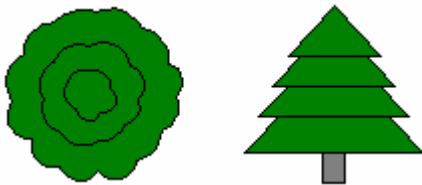

Trees (draw trunk and perimeter of foliage to approximate size).

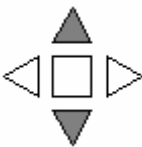

Traffic signal (grayed area indicates red).

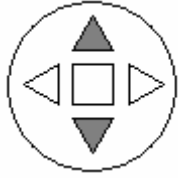

Flashing traffic signal (grayed area indicates red).



Traffic signs back to back.



Sign (indicate words or symbols)

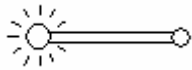

Street light and pole (arm length may change with scene).



Pole



Fire hydrant

All crosswalks, road surface symbols and other relevant markings should be depicted and drawn to approximate scale on the diagram as much as possible.

**DOT HS 811 676**  
**November 2012**



U.S. Department  
of Transportation  
**National Highway  
Traffic Safety  
Administration**



9121-110212-v2a