

AIR BAG TECHNOLOGY IN LIGHT PASSENGER VEHICLES

Prepared By The

OFFICE OF RESEARCH AND DEVELOPMENT

National Highway Traffic Safety Administration

JOHN HINCH

WILLIAM T. HOLLOWELL

JOSEPH KANIANTHRA

WILLIAM D EVANS

TERRY KLEIN

ANDERS LONGTHORNE

SABRINA RATCHFORD

JOHN MORRIS (RAINBOW TECHNOLOGY, INC.)

RAJESH SUBRAMANIAN (RAINBOW TECHNOLOGY, INC.)

JUNE 27, 2001

REVISION 2



Table of Contents

Sec	Title	Page Number
	List of Tables	ii
	List of Figures	iii
	Executive Summary	ES-1
1.0	Introduction	1
2.0	Discussion of Advanced Technology	2
3.0	Analysis of Air Bag System Trends by Model Year and Air Bag Inflator Power Characteristics . . .	9
3.1	Trend Analysis	9
3.2	Tank Test Data	12
3.3	Driver Air Bag Analysis	14
3.4	Introduction of Passenger Air Bags in Fleet	20
3.5	Passenger Air Bag Analysis	21
4.0	Air Bag Performance in Late Model Passenger Vehicles	26
4.1	NHTSA's Out-of Position Testing	26
4.1.1	Driver Air Bag Testing	26
4.1.2	Passenger Air Bag Testing	28
4.1.3	Two-Stage Air Bag Testing	29
4.1.4	Distance From the Air Bag Testing	29
4.2	Performance of New Model Vehicles with Redesigned Air Bag Systems in Rigid Barrier Tests	32
5.0	Discussion of Evolving Air Bag Fatality Trends Using SCI Data	34
6.0	Findings	38
	Appendix A	A-1
	Appendix B	B-1
	Appendix C	C-1
	Appendix D	D-1
	Appendix E	E-1

List of Tables

Num	Title	Page Number
Table 1.	Occupant Protection Technology.	3
Table 2.	Trend Data for Weighted Average Adjusted Driver Air Bag Inflator Peak Pressure and Rise Rate.	16
Table 3.	Trend Data for Weighted Average Adjusted Passenger Air Bag Inflator Peak Pressure and Rise Rate.	23
Table 4.	Neck Injury Data for Out-of-Position Testing for Position 1, by Model Year.	27
Table 5.	Neck Injury Data for Out-of-Position Testing for Position 2, by Model Year.	27
Table 6.	Neck Injury Reference Values for Acura RL Dual Stage Testing with Out-of-Position Dummy Placement.	29

List of Figures

Fig Num	Title	Page Number
Figure 1.	Illustrative Tank Test Data	12
Figure 2.	Weighted Average Air Bag Volume for IR Fleet by Model Year, Driver Side.	13
Figure 3.	Weighted Average Air Bag Volume for IR Fleet, by Model Year, Passenger Side.	14
Figure 4.	Weighted Average Adjusted Driver Air Bag Inflator Peak Pressure by Model Year.	15
Figure 5.	Weighted Average Adjusted Driver Air Bag Inflator Rise Rate, by Model Year.	15
Figure 6.	Weighted Average Adjusted Driver Air Bag Inflator Data.	16
Figure 7	Graphical Representation of Weighted Average Adjusted Driver Air Bag Inflator Output for IR Fleet Comparing MY 1997 to MY 1998.	17
Figure 8.	Adjusted Driver Air Bag Inflator Characteristics, by Direction of Change in Rise Rate and Peak Pressure.	18
Figure 9.	Frequency Distribution Plot showing Concentration Areas for Rise Rate and Peak Pressure, Adjusted Driver Air Bag Inflator Output, MY 1997.	19
Figure 10.	Frequency Distribution Plot showing Concentration Areas for Rise Rate and Peak Pressure, Adjusted Driver Air Bag Inflator Output, MY 1998.	19
Figure 11.	Vehicles in the IR Fleet with Driver or Passenger Air Bags, by Model Year.	20
Figure 12.	LTVs in the IR Fleet with Passenger Air Bags, by Model Year.	21
Figure 13.	Weighted Average Adjusted Passenger Air Bag Inflator Peak Pressure, by Model Year.	22
Figure 14.	Weighted Average Adjusted Passenger Air Bag Inflator Rise Rate, by Model Year.	22
Figure 15.	Weighted Average Adjusted Passenger Air Bag Inflator Data.	23
Figure 16.	Graphical Representation of Average Adjusted Passenger Air Bag Inflator Output for IR Fleet Comparing MY 1997 to MY 1998.	24
Figure 17.	Adjusted Passenger-Side Air Bag Inflator Characteristics, by Direction of Change in Rise Rate and Peak Pressure.	24
Figure 18.	Frequency Distribution Plot showing Concentration Areas for Average Rise Rate and Peak Pressure, Adjusted Passenger Air Bag Inflator Output, MY 1997.	25
Figure 19.	Frequency Distribution Plot showing Concentration Areas for Average Rise Rate and Peak Pressure, Adjusted Passenger Air Bag Inflator Output, MY 1998.	26
Figure 20.	Average Test Results for Neck Injury Measurements for Driver Out-of-Position Testing with 5 th Percentile Female Dummy.	28

Figure 21. Average Normalized Injury Criteria for Passenger Out-of-Position Testing with 6-Year-Old Child Dummy–Position 1.	29
Figure 22. Average Normalized HIC 15 msec for Passenger Out-of-Position Testing with 6-Year-Old Child Dummy–Position 1 at Various Clearances.	30
Figure 23. Average Normalized Neck Criteria for Passenger Out-of-Position Testing with 6-Year-Old Child Dummy–Position 1 at Various Clearances.	31
Figure 24. Average Normalized Chest Acceleration for Passenger Out-of-Position Testing with 6-Year-Old Child Dummy–Position 1 at Various Clearances.	31
Figure 25. Average Normalized Chest Deflection for Passenger Out-of-Position Testing with 6-Year-Old Child Dummy–Position 1 at Various Clearances.	32
Figure 26. Driver Normalized Injury Measures in 30 mph Unbelted Barrier Tests.	33
Figure 27. Right Front Passenger Normalized Injury Measures in 30 mph Unbelted Barrier Tests.	34
Figure 28. SCI Data for Fatal Drivers Normalized for Registrations of Vehicles with Driver Air Bags, by 12 Month Interval.	35
Figure 29. SCI Data for Fatal Passengers Normalized for Registrations of Vehicles with Passenger Air Bags, by 12 Month Interval.	35
Figure 30. SCI Data for Fatal Drivers Normalized for Vehicle Registrations, by Model Year.	37
Figure 31. SCI Data for Fatal Passengers Normalized for Vehicle Registrations, by Model Year.	37

Executive Summary

In December 1997, the National Highway Traffic Safety Administration (NHTSA) sent an information request to nine automobile manufacturers requesting detailed technical information on the current industry practice on air bag technologies, and how air bag design and performance characteristics had evolved through the 1990's. The manufacturers provided the agency with the requested data, much of which was proprietary and confidential. The data included information on MY 1990 through MY 1998 vehicles.

This report uses those data, as well as other available information, to illustrate the general trends in air bag design and performance characteristics. It also uses data from static and dynamic tests of various air bags and an assessment of air bag performance in terms of injury measures made on dummies representing occupants under low speed and high speed conditions. It also discusses the results of investigations of real world crashes by NHTSA's Special Crash Investigations office. The report is only intended to provide an overview of the trends in air bag characteristics and design changes. The limited analyses presented in this report are not intended to be a comprehensive report on the projected safety performance of the past, present, or future vehicle fleet.

Section 1 of the report gives the background which led to the information request. Section 2 provides a summary of various advanced air-bag related technologies that are actively being considered by the manufacturers. Additionally, a brief description of air bag design changes and air bag performance measures are given for both driver and passenger air bags. Section 3 discusses general trends, including a detailed analysis of inflator output trends over time. Section 4 gives a discussion of the static and dynamic test results from air bag aggressivity and vehicle crash tests conducted by the agency. Section 5 provides a discussion of the trends in real world fatalities due to air bags. Section 6 gives a summary of the findings.

The agency's analyses of the data show some of the ways in which air bag technology is evolving. There have been numerous changes in air bag design both on the driver side and the passenger side.

Some of the changes in air bag design reduce their aggressivity, an issue to which NHTSA has given a great deal of attention. Since the problem of air bag deaths first emerged, NHTSA has taken a number of steps to address the problem. In late November 1996, the agency announced that it would be implementing a comprehensive plan of rulemaking and other actions (e.g., consumer education) addressing the adverse effects of air bags. Recognizing that a relatively long period of lead time is required to make some types of significant design changes to air bags, the agency's comprehensive plan called for both interim and longer-term solutions. The interim solutions included temporary adjustments in Standard No. 208's performance requirements to ensure that the vehicle manufacturers had maximum flexibility to address quickly the risks from air bags. One such change was to permit manufacturers to certify their vehicles to an unbelted sled test option instead of the unbelted 30 mph

rigid barrier test. This facilitated efforts of the manufacturers to make quick design changes to their air bags, such as reducing inflator power.

Data provided by the manufacturers show that air bag outputs have been reduced significantly in the most recent model year (MY) vehicles in comparison to the earlier generation vehicles. While there are many means by which air bag aggressivity can be reduced, reducing air bag outputs is a quick means of accomplishing this goal. The agency's analyses also show that, between MY 1997 and MY 1998, 50 to 60 percent of the vehicles in the fleet covered by the information request lowered the output of the driver-side air bag, while about 50 percent of the fleet lowered the output for the passenger side. Comparison of the data for MY 1997 and MY 1998 vehicles show that, on average, the pressure rise rate in MY 1998 vehicles decreased about 22 percent for the driver air bag and 14 percent for the passenger air bags.

The data provided by the manufacturers also show that they have made significant changes in the design of their air bag systems other than the air bag pressure rise rate and peak pressure in their air bag designs, some over a period of many years. One change is the recessing of driver air bags so that the module is located farther away from the plane of the steering wheel, and thus farther from the driver. Although this practice was not common in the early 90's, it is found in almost half of the MY 1997 and MY 1998 vehicles. Similarly, the air bag mounting location on the passenger side has also shown significant changes. Other features, such as cover tear patterns, tear pressure, fold patterns and the number and type of tethers have changed in recent years, all of which may have collectively contributed to reduced aggressivity of air bags.

NHTSA conducted tests on the aggressivity of air bags in certain MY 1996, MY 1998 and MY 1999 vehicles. Static tests were conducted with 5th percentile female dummies in the driver seating position and 6-year-old dummies in the passenger seating position, placed in two positions in close proximity of the air bag. Various dummy injury measures, such as the Head Injury Criteria (HIC), chest accelerations, chest deflections, and neck injury measures were obtained. These results showed that the air bags in MY 1998 and 1999 vehicles, generally, posed less of an injury risk to out-of-position occupants than the air bags in the MY 1996 vehicles. However, it should be noted that, for each model year, only a few vehicles were tested. While NHTSA attempted to select vehicles that were representative of the existing fleet, firm conclusions can only be reached after testing additional vehicles.

NHTSA has conducted special crash investigations to assess whether there has been a reduction in the rate of air bag-induced fatalities for later MY vehicles. While there has been little change in the driver air bag fatality rate between MY 1992 and MY 1997 vehicles, there has been a significant reduction in fatality rate in MY 1998 vehicles and no driver air bag fatalities, thus far, in MY 1999 vehicles. There has also been reduction in passenger fatality rate in recent MY vehicles, with MY 1998 showing an appreciable reduction.

One concern about reducing inflator power is potential loss of protection in high severity crashes. To help see how vehicles certified to the unbelted sled test perform in high severity crashes, NHTSA tested

13 production vehicles from MY 1998-1999, in a 30 mph barrier test using unbelted 50th percentile dummies in the driver and passenger seating positions. For the driver dummy, except for the femur loads for one vehicle, the injury measures for the femurs, chest (accelerations and displacements), head, and neck were below the requirements specified in FMVSS No. 208, with most below 80 percent of the threshold values. For the passenger seating position in one vehicle, the chest acceleration slightly exceeded the FMVSS No. 208 requirement. All the other injury measures met the requirements in FMVSS No. 208. Again, most were below 80 percent of those requirements. Thus, with minor exceptions, the tested vehicles, although certified to the sled test, also passed the pre-existing 30 mph unbelted rigid barrier crash test.

Some advanced technologies are already in some vehicles and are expected to be used in additional vehicles in the early 2000's model years, as a result of NHTSA's ongoing rulemaking to require advanced air bags. Some of the technologies identified extend from changes in inflator characteristics, new air bag shapes, sizes, fabrics, venting systems and venting levels, occupant size and location sensors, seat position sensors, belt use sensors, and crash severity sensors to computation algorithms that use the information in making air bag deployment decisions.

In conclusion, risks to out-of-position occupants have been reduced in recent years. These reduced risks can be ascribed, at least in part, to the following:

- On average, the inflator outputs of recently redesigned air bags have been significantly reduced. While there are variations among manufacturers and among vehicles of each manufacturer, analysis of the data provided by the manufacturers show a significant reduction in the average peak pressure and pressure rise rate of MY 1998 air bags in comparison to earlier air bags. However, those parameters increased in approximately ten percent of the vehicles covered by the information request and approximately one third showed no change.
- Changes in air bag volumes, vent sizes, inflator characteristics and other design changes have all contributed to a reduction in the safety risk from air bags, which is reflected in the dummy injury measures obtained from static deployment of air bags of various model years as well as in real world crash investigations.
- Based on static and dynamic tests using adult and child dummies and the injury measures obtained in those tests, it is clear that air bags in recent MY 1998 and 1999 vehicles are less aggressive than the pre-MY 1998 air bags. As such, these air bags generally pose less of an injury risk to out-of-position occupants. The special crash investigations of real-world cases tend to confirm this general trend showing a significant reduction in fatality rates due to air bags in recent MY vehicles.
- In high speed rigid barrier tests at 30 mph of seven MY 1998 and six MY 1999 vehicles, unbelted, 50th percentile male dummies were used in the driver and passenger seating positions. The dummy injury measures for the 50th percentile male driver dummy showed that the HIC,

chest “g,” chest deflection and the neck injury measures (Nij) were all within the threshold values. In a MY 1999 vehicle, the femur load exceeded the limit. For the passenger dummy, the chest “g” value exceeded the limit by 1.4 “g” in one vehicle and all others met the requirements.

- Manufacturers have made many changes to air bag designs. They are also on the threshold of making a significant leap in introduction of sophisticated technologies to improve air bag performance. For example, tailored inflation to suit different size occupants located in various positions in relation to the air bag and to match the severity of the crash will be a reality in the not too distant future. NHTSA’s ongoing rulemaking to require advanced air bags will ensure that future air bags provide improved protection of belted as well as unbelted occupants of different sizes in moderate to high speed crashes, while minimizing risks posed by air bags to infants, children, and other occupants, especially in low speed crashes.

1.0 Introduction

On December 17, 1997, the Associate Administrator for Safety Performance Standards of the National Highway Traffic Safety Administration (NHTSA) sent a letter to nine vehicle manufacturers¹ requesting detailed technical information about the frontal crash protection systems of vehicles that they had designed, built, and sold during model years 1990-1998. Over time, numerous design and performance changes have been made by vehicle manufacturers to their vehicles' frontal crash protection systems to both mitigate the risk to occupants and improve the performance of these systems. These occupant protection systems included air bags, safety belts, crash sensors, steering system components such as steering wheels and steering column, knee bolsters, dash boards, and the vehicle structures on which they were mounted. The primary purpose of the information request was to provide NHTSA with specific technical information documenting these changes over time. Among other things, the agency wanted to understand the specific changes made in occupant restraint design subsequent to its March 19, 1997, final rule that allowed manufacturers to temporarily certify their vehicles to Federal Motor Vehicle Safety Standard (FMVSS) No. 208 using a sled test instead of a rigid barrier test.

Pursuant to the Intermodal Surface Transportation Efficiency Act of 1991, passenger cars and light trucks are required to have air bags at the driver position and the right front passenger position. As of September 1, 1999, NHTSA estimates that air bags have saved over 4,600 lives. However, in the early 1990's, fatalities and serious injuries caused by air bags began to occur. In November, 1996, NHTSA announced a comprehensive plan in response to public concerns related to occupants, especially children who are out-of-position, being injured or killed by deploying air bags. At the time the information request was made, NHTSA had completed or was working on three rulemaking initiatives that the agency believed would minimize occupant injury risks due to deploying air bags while preserving the benefits of the occupant protection system.

On March 19, 1997, NHTSA implemented the first step in this plan by facilitating efforts of vehicle manufacturers to quickly redesign these air bags by certifying their vehicles to FMVSS No. 208 using a sled test with a generic crash pulse instead of a rigid barrier test. This action resulted in air bags in most MY 1998 vehicles being redesigned, with most having reduced inflator output and aggressivity.

Beyond the concerns with the early and current generation air bags, the agency continued to take steps in regards to future air bags. The enactment of the Transportation Equity Act for the 21st Century (TEA 21) on June 9, 1998, required NHTSA to initiate new rulemaking on air bags. On September 17, 1998, the agency published a new proposal to amend FMVSS No. 208 to require advanced air bags. The goal of this proposal was to improve occupant protection for occupants of different sizes, regardless of whether they use their seat belts, while minimizing the risk to infants, children, and other occupants of deaths and injuries caused by air bags. The proposal gave automakers the maximum

¹ The manufacturers were: Chrysler, Ford, General Motors, Honda, Mercedes-Benz, Nissan, Toyota, Volkswagen and Volvo. The vehicles which are covered by their responses will be called the "IR Fleet."

flexibility to pursue effective technological solutions. The proposal incorporates additional air bag system performance tests and requirements to increase protection for properly seated adults, and to greatly reduce air bag deployment risks for infants, young children and small adults.

Our comprehensive plan provided for a rapid change in air bag designs, a method for occupants at high risk to obtain on-off switches for air bags in their present vehicles, and a proposal to improve air bag performance in future vehicles.

These rapid changes gave rise to two questions. First, what technological advances have actually been incorporated in automobile designs by vehicle manufacturers to enhance safety in frontal crashes? Secondly, how do those changes affect occupant safety, especially as the risk to occupants from air bags became better understood?

The December 17, 1997 information request (IR) was intended to address these questions. First, the agency needed to identify the technical changes being made in motor vehicles for frontal crash protection. By identifying those design changes, the agency could determine whether changes in injury and fatality patterns in frontal crashes correlated to the changes in air bag design and other vehicle characteristics. This could allow the agency to identify the most significant performance characteristics of an occupant restraint system, and the vehicle designs that achieved the best safety performance.

The analysis in this report aggregates the data obtained from the manufacturers to avoid disclosing confidential information.

2.0 Discussion of Advanced Technology

As part of the IR, NHTSA requested information on advanced technology. Based on a review of the manufacturers' responses, the types of advanced occupant protection technologies introduced by these nine manufacturers are presented in Table 1. Also included are advances and improvements in technologies that were used in the design and development of their early air bag systems. Since other manufacturers who were not sent the IR were also producing motor vehicles at the same time, it is quite possible that those manufacturers also developed and introduced other technologies during the same time period. Further, there may be additional safety systems introduced by manufacturers which were not identified during the IR process. A discussion of new technologies which post-date the IR responses is also presented in the table.

Table 1. Occupant Protection Technology.

Technology	Description of Technology	Based on the IR response	Discussion of Activities which Post-Date the IR
Buckle Sensors	Sensors that sense if the occupant is wearing the seat belt. For use in systems with dual level air bag inflation thresholds, permitting a different level of deployment crash velocity for belted and unbelted occupants.	Mercedes had buckle sensors on all model years MY 1990-98. This represents about one percent of the IR fleet.	Honda installed these devices in MY 1999. Other manufacturers are currently implementing these sensors for MY 2000. Future use of the buckle sensor will allow different inflation levels for belted and unbelted occupants (i.e., low level for belted and high level for unbelted).
Pre Tensioners	A device, usually pyrotechnic, to remove slack from the seat belt upon detection of a crash condition.	Driver: Mercedes, Volkswagen & Volvo in MY 1990, Honda in MY 1991, Nissan & Toyota in MY 1993, Chrysler in MY 1996, GM in MY 1997. Passenger: Mercedes in MY 1990, Honda in MY 1991, Volkswagen in MY 1992, Toyota, Nissan & Volvo in MY 1993, GM in MY 1997.	
Load Limiters	A device to limit the forces imparted to the occupant by the seat belt during the crash event. The forces are prevented from exceeding a predetermined level by allowing the seat belt webbing to yield when the forces reach this level.	Driver: Toyota introduced it in MY 1990, Chrysler & GM in MY 1991, Ford & Honda in MY 1993, Mercedes in MY 1996, Nissan, Volkswagen & Volvo in MY 1998. Passenger: Chrysler, Ford, Gm, Honda & Toyota in MY 1994, Mercedes in MY 1996, Nissan, Volkswagen & Volvo in MY 1998.	
Web Clamps	A device in the seat belt retractor that locks the webbing to prevent or minimize shoulder belt spool-out.	Driver: GM, Honda & Nissan in MY 1990, Ford in MY 1991, Chrysler in MY 1992, MY Toyota in MY 1993, GM in MY 1997. Passenger: Honda in MY 1991, Chrysler in MY 1993, Ford, Nissan & Toyota in MY 1994, GM in MY 1997.	

Table 1. Occupant Protection Technology.

Technology	Description of Technology	Based on the IR response	Discussion of Activities which Post-Date the IR
Advanced Crash Sensing	Sensors that discriminate crash severity. For use with systems utilizing staged air bag inflation. Also used in dual threshold air bag systems.	Information on this technology was not requested in the IR.	Several Manufacturers will soon be adding this technology which will discriminate crashes based on crash severity.
Multi Stage Inflation	A multi staged air bag system is a system that can control two or more air bag inflation stages independently to optimize occupant protection, i.e., a low stage for a small occupant and a high stage for a larger person.	None reported	Honda installed multi stage inflators on passenger side in MY 1999. Other manufacturers will be using this technology beginning in MY 2000.
On/off Switch	A switch to deactivate the passenger air bag. For use when children can only be transported in the front seat, such as in pickup trucks, or when there is not sufficient room to put a child seat in the back seat.	GM: C/K, S-10 and Sonoma trucks in MY 1997-98 models; FORD: F-series trucks, Ranger & Mazda B-Series in MY 1997-98 models; CHRYSLER: Dodge Dakota, Ram Pickups in MY 1998.	
Child Seat Sensors (Tags)	Sensors that sense if a child seat is occupying the front passenger seat. For use in systems where the passenger air bag is designed not to deploy or deploy with decreased force if a child seat is placed on the front passenger seat.	Mercedes introduced this in MY 1998.	
Seat Position Sensors	Used to sense driver seat adjustment position. For use in systems where the air bag is designed not to deploy or deploy with decreased force if the seat is positioned in close proximity to the air bag.	No manufacturer reported using Seat Position Sensors in the IR fleet.	One manufacturer will install seat position sensors in MY 2000.
Weight/Pattern Recognition Type Sensors	Sensors that sense if the front passenger seat is occupied. Used to discriminate children and child seats from adults. For use in systems where the passenger air bag is designed not to deploy or deploy with decreased force if the front passenger seat is occupied by a child or a child restraint.	No manufacturer reported using Weight Sensors in the IR fleet.	Manufacturers will begin installing weight/pattern recognition sensors in MY 2000. Wide use is expected in the next model year or two.

Table 1. Occupant Protection Technology.

Technology	Description of Technology	Based on the IR response	Discussion of Activities which Post-Date the IR
Capacitance Sensors	Sensors utilizing an electrical field to determine if the front passenger seat is occupied and the location and size of the occupant. For use in systems where the passenger air bag is designed to not deploy or deploy with decreased force if a child or out of position occupant is occupying the seat.	Information on this technology was not requested in the IR.	Some may be in use, but research is ongoing.
Pre-crash Sensors	A sensor that senses an impending crash and could allow a crash severity sensor to make an earlier decision on whether or not to deploy the air bags. This could lead to reduced air bag deployment force on the occupant.	No manufacturer reported using Pre-crash Sensors in the IR fleet.	Research underway
Infrared Sensors	Sensors utilizing heat detection to determine if the seat is occupied and the location and size of the occupant. For use in systems where the air bag is designed to not deploy or deploy with decreased force if a child or out of position occupant is occupying the seat.	Information on this technology was not requested in the IR.	Under research and may be introduced soon.
Inflatable Knee Bolsters	Small cylindrical air bags located at the bottom of the instrument panel to reduce femur forces during the crash event.	No manufacturer reported using Inflatable Knee Boosters in the IR fleet.	Some manufacturers have used these devices and others are planning their use.
Hybrid Inflators	Device used to generate the gas to inflate the air bag. Can be classified as pyrotechnic, hybrid or compressed gas. The predominant driver and passenger side inflators have been the pyrotechnic type.	DRIVER: In MY 1998 manufacturers introduced hybrid driver inflators. PASSENGER: In MY 1998 about 45 per cent of the passenger side inflators were the hybrid type.	
Crash Sensors	Device used to sense an impending crash, generally electromechanical or electronic, or a combination of each (electronic-electromechanical). In the early 1990's the vast majority of crash sensors were multiple electromechanical (spring mass).	TRENDS: The trend is toward either a single electronic or a combination electronic-electromechanical sensor, 73 percent in MY 1998. Also in MY 1998, 44 percent of the vehicles in the IR fleet had only one crash sensor.	

Table 1. Occupant Protection Technology.

Technology	Description of Technology	Based on the IR response	Discussion of Activities which Post-Date the IR
Tethers	Internal straps used to control the shape of the air bag.	<p>Driver: In the early 1990's the majority of the driver air bags had no tethers. In MY 1998, 88 percent of all vehicles in the IR fleet had two or more driver air bag tethers.</p> <p>PASSENGER: The majority of passenger air bags remain untethered.</p>	
Inflation Time	Time from initiation of air bag inflation to full air bag inflation	<p>TREND: The average time for driver air bag inflation has been consistent since MY 1990, approximately 33 ms. The average time for passenger air bag inflation was 12 percent less in MY 1998 (52 ms) than MY 1993 (59 ms).</p>	
Area of Opening	The area of the opening through which the air bag is deployed.	<p>TREND: Although there has been a 19 percent reduction in air bag volume, the area of the driver air bag opening has remained constant. In contrast, the passenger air bag opening has remained constant while its volume has decreased 27 percent on average.</p>	
Air Bag Deployment Distance	The average distance from the air bag module to the maximum rearward point the air bag reaches, <u>Distance A</u> , and the average distance from the seating reference point (SRP) to the maximum rearward point the air bag reaches, <u>Distance B</u> .	<p>DRIVER: Distance A has decreased approximately one inch since MY 1991 and Distance B has increased approximately three inches since 1991, placing the aft face of the deployed air bag further from the driver.</p> <p>PASSENGER: For mid mounted² air bags Distance A has decreased approximately 6 inches and Distance B increased about 9 inches placing the air bag further from the passenger. Distance A has been constant for top mounted air bags.</p>	

² Mid mounted passenger air bags are mounted in the portion of the instrument panel facing the passenger, while top mounted passenger air bags are mounted in the top portion of the instrument panel, typically facing upward toward the windshield.

Table 1. Occupant Protection Technology.

Technology	Description of Technology	Based on the IR response	Discussion of Activities which Post-Date the IR
Air Bag Volume		<p>DRIVER: The average volume of the driver air bag has remained constant since MY 1990 (approximately 56 liters).</p> <p>PASSENGER: The average volume of the passenger air bag was 27 percent smaller in 1998 (120 liters) than it was in MY 1993 (165 liters).</p>	
Air Bag Mounting Location	<p>The driver air bag can be either recessed, flush, or protruding from the steering wheel. The passenger air bag can be either top or mid mounted on the passenger side of the instrument panel.</p>	<p>DRIVER: The trend has been toward an increase in recessed driver air bags and a decrease in protruding air bags.</p> <p>PASSENGER: The trend has been toward an increase in mid mounted air bags and a decrease in top mounted air bags.</p>	
Tear Patterns	<p>The four predominant tear patterns for the driver air bag are the H, U, I, and horizontal. See Appendix A for description.</p> <p>The four predominant tear patterns for the passenger air bag are the H, U, and horizontal plus a breakaway door. See Appendix A for description.</p>	<p>DRIVER: Predominantly an H shaped tear, the current trend shows an increase in I and U shaped tear patterns and a decrease in the H shaped tear pattern.</p> <p>PASSENGER: Predominantly a horizontal shaped tear, the current trend shows the H shaped tear pattern increasing and the number of air bag module cover doors decreasing.</p>	
Minimum Breakout Pressure	<p>The minimum pressure required for the air bag to break through the air bag cover at the time of deployment</p>	<p>DRIVER: Since MY 1993 the average minimum breakout pressure for the driver air bag has decreased 28 percent.</p> <p>PASSENGER: Since MY 1993 the average minimum breakout pressure has decreased 24 percent.</p>	

Table 1. Occupant Protection Technology.

Technology	Description of Technology	Based on the IR response	Discussion of Activities which Post-Date the IR
Fold Pattern	<p>The predominant driver air bag fold patterns are the accordion, reverse roll, overlap, and modified accordion. See Appendix A for a description. The predominant passenger air bag fold patterns are the accordion, roll, overlap, and rotated accordion. Again see Appendix A for a description.</p>	<p>DRIVER: The reverse roll has been the predominant driver air bag fold pattern since 1990. The number of driver air bags with overlap folds has increased since MY 1993.</p> <p>PASSENGER: The trend in passenger air bag folds has been an increase in rotated accordion and roll folds and a decrease in accordion folds.</p>	

3.0 Analysis of Air Bag System Trends by Model Year and Air Bag Inflator Power Characteristics

The manufacturers' air bag systems data were analyzed to determine various trends. In order to use these data, NHTSA compiled the data in an electronic file using a uniform format. During this review, NHTSA made several revisions to the input data, as a result of communications with the manufacturers.

Appendix A consists of analyses of the data submitted to NHTSA in response to the questions in the Information Request (IR). This appendix presents a number of graphical representations of the data contained in the IR computer file, in summary form. The data are presented by model year of vehicles, and weighted by the number of vehicles sold, as reported by R.L. Polk in the National Vehicle Population Profile. It should be noted that in the early years presented in the graphs, not all vehicles were equipped with air bags, especially passenger air bags. Therefore, changes over time (model year) do not necessarily represent changes in air bag characteristics, but may also represent introductions of air bags, especially passenger air bags, into the fleet as new vehicles became equipped with these new systems. The introduction to Appendix A provides a description of the types of information presented on each page.

Data Collection Processes and Data Definitions

NHTSA received the data related to air bag systems from manufacturers in response to the agency's letters. The outgoing letter which lists the questions is presented in Appendix B. Throughout the report and in responses to questions, several references are used to describe specific locations of certain components within the vehicle. These definitions are also found in the outgoing letter.

NHTSA also informally requested electronic copies of each major submission which was utilized, along with the hard copy submission, to develop a computerized, standard format for the data. Throughout the analytical process, NHTSA communicated with the manufacturers to obtain clarifications and replacement data where the submissions were ambiguous or erroneous.

Discussion of weighting

Manufacturers submitted data specific to each make/model/model year combination. NHTSA did not request sales data for each type of vehicle sold. The analysis used sales data obtained from R.L. Polk. These data were then used to weight each make/model/model year.

3.1 Trend Analysis

The following discussion is based on Appendix A. For further discussion, please refer to the appendix.

Driver Air Bag Location: Some manufacturers have changed the location of the driver air bag. From MY 1990-1998, there has been an industry trend to recess the driver air bag into the steering column, with nearly 50 percent having the air bag recessed in MY 1998, up from about 10 percent in the early years covered by the IR. This change has been relatively slight, with the average of all driver air bags in the IR fleet being recessed about 0.2 inches below the plane of the steering wheel in MY 1998.

Passenger Air Bag Mounting Location: There has been a trend to move toward mid-mounted air bags, increasing from about 20 percent in MY 1990 to over 50 percent in MYs 1997 and 1998.

Direction of Movement of Air Bag Module: Analysis of whether the driver air bag module was designed to move away from the occupant during deployment indicated that very few manufacturers employed this technology, about 5 percent in MY 1998. A similar trend was observed on the passenger side, but here about 15 percent of the modules were designed to move away from the occupant in MY 1998.

Air Bag Module Opening Size: The size of the opening of the air bag module has decreased over the years for driver air bags. The average opening size was about 40 square inches in MY 1990, and decreased to about 33 square inches in MY 1998. On the passenger side, the average opening size has remained about constant, at about 70 square inches. Similar trends were observed for the air bag cover opening.

Breakout Pressure: Minimum breakout pressure on the driver side has decreased somewhat, from an average of about 41 psi in MY 1990 to 31 psi in MY 1998. On the passenger side the pressure has decreased from about 54 psi in MY 1993 to an average of about 38 psi in MY 1998.

Cover Mass: The average mass of the bag cover has remained nearly constant over the years - about seven ounces on the driver side and about 14 ounces on the passenger side.

Door Tear Pattern: There was an observable trend in the type of tear patterns on the driver side. "U" shaped and "I" shaped tear patterns have become more common in the last 5 years, accounting for nearly 40 percent in MY 1998. "Horizontal" tear patterns have remained about constant, while "H" shaped patterns have decreased markedly over the years. On the passenger side, the use of the "H" shaped tear has increased and the use of the "U" shape tear has decreased, while the others do not show any clear indication of a trend.

Bag Fold Patterns: Fold patterns have remained fairly constant over the years on the driver side, with a slight increase in the "overlap" design. On the passenger side, there has been a slight decrease in the "accordion" type in favor of the "rotated accordion" type.

Air Bag Mass: The mass of the air bag itself has decreased slightly over the years on the driver side, going from an average of about ten ounces in MY 1990 to nine ounces in MY 1998. On the passenger side, it decreased from an average of about 22 ounces in MY 1993 to about 20 ounces in MY 1998.

Air Bag Inflation Time: The average amount of time required to inflate the air bag has been relatively constant over the years at 33 milliseconds for driver air bags. On the passenger side, it has also been constant for the past 5 years at 50 milliseconds.

Air Bag Volume: The volume of the driver air bag has remained about the same over the years, at an average of about 56 liters. On the passenger side, the volume has decreased from an average of about

160 liters in MY 1993 to about 120 liters in MY 1998.

Number of Tethers: The number of tethers for the driver air bag has varied over the years. In the early years either “0” or “3 or more” prevailed. In the later years there has been a trend toward “2” tethers. On the passenger side, no clear trend exists, with manufacturers using all combinations of tethers, but the use of “no tethers” has been the most common.

Driver Air Bag Deployment Distance: The maximum extent to which the driver air bag deploys has decreased somewhat over the years, from an average of 15 to 16 inches in the early years to about 14 inches in MY 1998. The proximity to the Seating Reference Point (SRP) has changed. The current air bags do not extend as close to the SRP as previous air bags did. Lateral deployment of the driver air bag has decreased also, from an average of about 27 inches in width in MY 1990 to about 25 inches in MY 1998.

Passenger Air Bag Deployment Distance: For top-mounted air bags, the fore-aft mounting location of the air bag relative to the front of the instrument panel has remained constant at an average of about seven inches. For mid-mounted air bags the average distance from the center of the door opening to the top of the instrument panel has also remained constant at an average of about four inches. The average mounting height for mid-mounted air bags relative to the SRP has decreased somewhat from about 15 inches in MY 1993 to about 13 inches in MY 1998. The deployment distance (maximum extent to which the air bag deploys) of top-mounted air bags, relative to the center of the air bag cover, has remained steady at an average of about 27 to 28 inches. For mid-mounted air bags, this distance has decreased over the years from about 29 inches in MY 1993 to about 23 inches for MYs 1996-1998. For these mid-mounted air bags, proximity to the SRP (maximum extent to which the air bag deploys relative to a transverse vertical plane that passes through the SRP) has decreased about an average of eight to nine inches, from overlapping the SRP by six inches in MY 1993 to not reaching the SRP by an average of two to three inches in MYs 1996 through 1998. The maximum lateral extent of the passenger air bags has decreased from an average of about 31 inches in MY 1993 to about 24 inches in MY 1998.

Inflator Type: No trend was observed in inflator type on the driver side, with almost all manufacturers using a pyrotechnic type. On the passenger side, hybrid types have made an appearance over the past five years, and are currently being used in about half of the vehicles.

Inflating Agent: Sodium azide is by far the most predominant agent in the modules on the driver side. Arcite was used in a few vehicles in MY 1998. On the passenger side, argon, PVC, hydrogen, and helium have been used to replace sodium azide, with approximately 50 percent of the vehicles using non-sodium azide agents in MY 1998.

Multi-Stage Inflation: Multi-stage inflators were not used in the IR fleet on either the driver or passenger side.

Seat Belt Stiffness: For the driver and passenger sides, the seat belt stiffness has remained about

constant at around eight to nine percent elongation per unit load.

Load Limiters: Load limiters have been introduced into the fleet in increasing numbers. On the driver side they have increased from none in MY 1990 to about 40 percent of the vehicles in MY 1998. On the passenger side, a similar trend was observed.

Pre-Tensioners: Pre-tensioners were used in a small percentage of the vehicles through MY 1997. In MY 1998, their use in vehicles increased to about 15 percent.

Web Clamps: Web clamp use has been varied over the years from about five to 30 percent.

Number, Location, and Type of Air Bag Controller Sensors: There has been a trend toward fewer sensors over the years. In the early years, 3, 4, or more sensors predominated. In the later years, the use of single point sensors has grown to over 40 percent. There has been a trend of moving sensors from the crush zone in the early years to inside the occupant compartment in the later years. The type of sensor has also changed over the years, from electromechanical in the early years (about 85 percent in MY 1990) to electronic type sensors in the later MYs (about 50 percent in MY 1998).

3.2 Tank Test Data

Air bag inflator output performance characteristics often are defined using a “tank test.” In a tank test, the inflator is placed in a pressure vessel and deployed. A photo of a tank test vessel is found in Appendix C. A time history of the pressure inside the pressure vessel is measured. A typical test outcome is depicted in Figure 1.

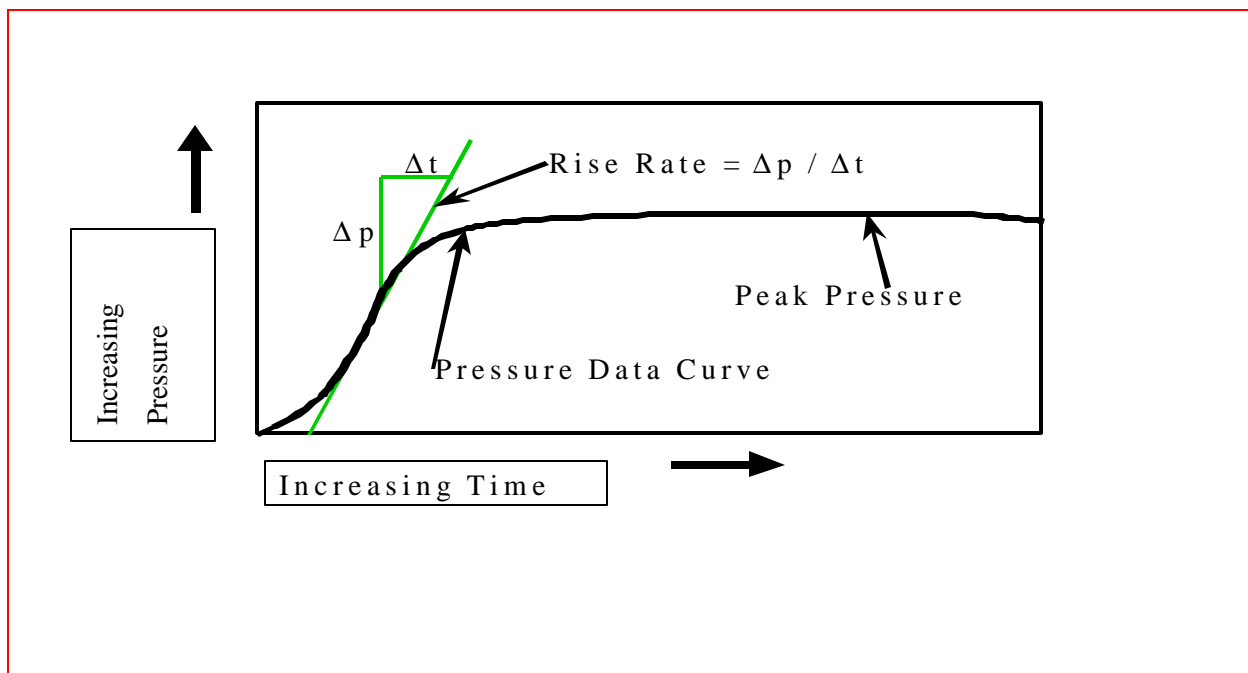

Figure 1. Illustrative Tank Test Data.

In response to the IR, the manufacturers supplied NHTSA these data for the driver and passenger air bag inflators for all models equipped with air bags. The data were presented in graphical form. Using these graphs, NHTSA determined the average peak pressure and rise rate for each inflator.

Determination of Peak Pressure and Rise Rate:

The average rise rate was approximated by NHTSA by manually fitting a best-fit line to the data in the area where the pressure was changing the fastest, and then determining the slope of the line. The peak pressure was defined as the maximum pressure obtained in the pressure vessel during the test. Typically this occurred at or near the end of the data curve.

Adjustment for Vehicle Air Bag Size: Both driver and passenger air bag inflators were analyzed. The first step in analyzing these inflator tank tests was to normalize for the volume of the air bag installed in the vehicle. This was done by holding the pressure-volume ratio constant, i.e., the adjusted pressure is equal to the peak pressure from the tank test times the volume of the tank divided by the volume of the air bag installed in the vehicle. A similar process was used for rise rate. Since all inflators are tested in standard-size test tanks, but may be designed for use with different size air bags, the agency believed that this normalization was necessary to conduct a valid comparison of different air bag characteristics. In particular, passenger air bags are much larger than driver air bags. The average air bag volumes by model year for driver and passenger seat positions are presented in Figures 2 and 3, respectively. While there has been little change in driver air bag volume from one model year to the next, the passenger side shows a significant reduction in air bag volume in later years, as seen in Figure 3.

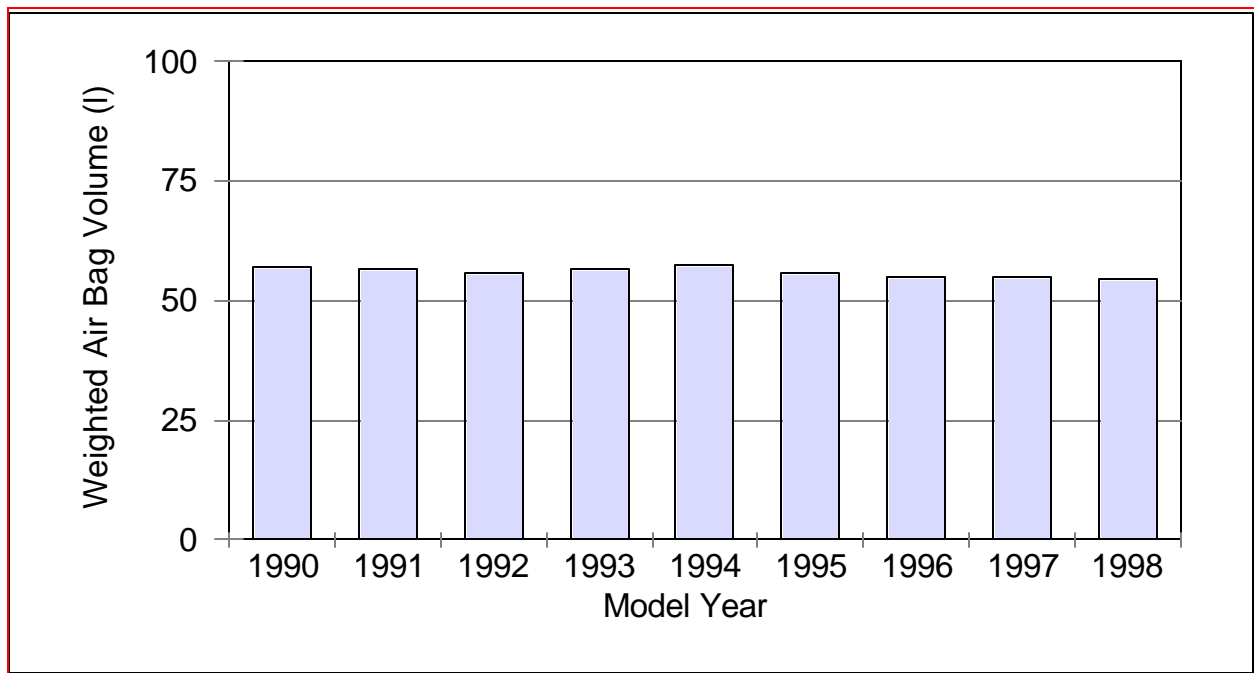

Figure 2. Weighted Average Air Bag Volume for IR Fleet by Model Year, Driver Side.

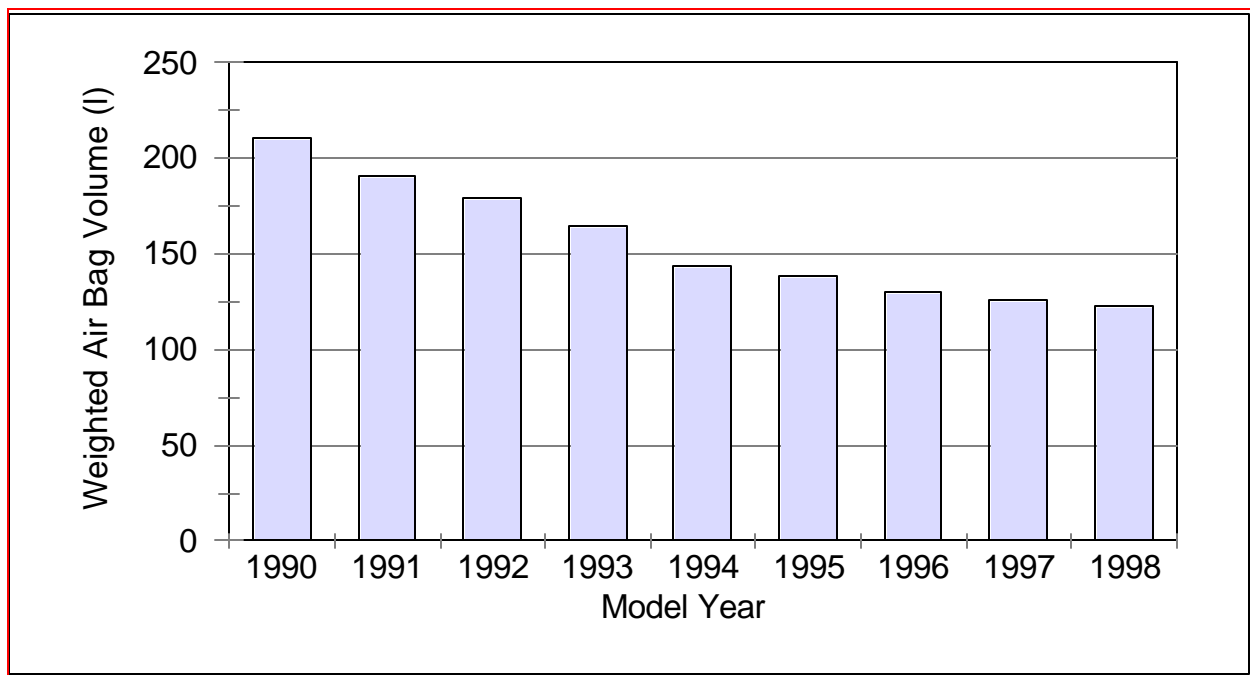

Figure 3. Weighted Average Air Bag Volume for IR Fleet, by Model Year, Passenger Side.

The weighted average for the driver air bag volume in the IR fleet has remained fairly constant at about 55 liters, while the passenger air bag volume has decreased by a factor of nearly 2, from an average of over 200 liters in MY 1990 to about 120 liters in MY 1998. The rate of decrease in volume on the passenger side has leveled off during the past 3 years. Thus, based on the individual make/model/model year combination, the peak pressure and rise rate tank test data were adjusted. If the air bag was larger in volume than the tank volume, the peak pressure and rise rate were reduced by the ratio of these volumes and vice-versa. These data will be referred to as “adjusted data.”

3.3 Driver Air Bag Analysis

The adjusted data for the driver air bag inflators was used to determine the weighted average for the IR Fleet by model year. Figures 4 and 5 present these data for the peak pressure and rise rate by model year.

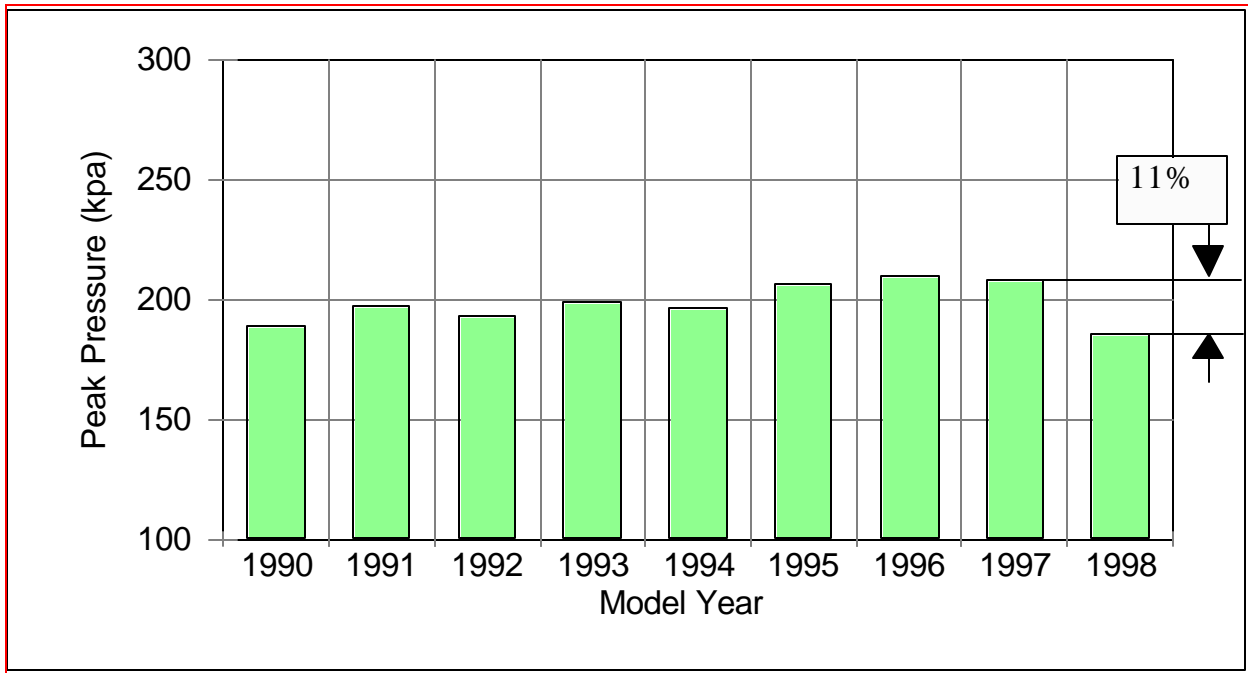

Figure 4. Weighted Average Adjusted Driver Air Bag Inflator Peak Pressure by Model Year.

In Figure 4, adjusted peak pressure from the IR Fleet’s air bag inflator output is seen to increase slightly from MY 1990 through MY 1997. From MY 1997 to MY 1998 the average peak pressure decreased by about 11 percent. Likewise, as seen in Figure 5, the average adjusted rise rate data for the driver air bag inflators show a similar trend, but there was a larger decrease in MY 1998 from the previous years. Figure 6 presents a composite of the data, showing a cross-plot of the average peak pressure and rise rate data.

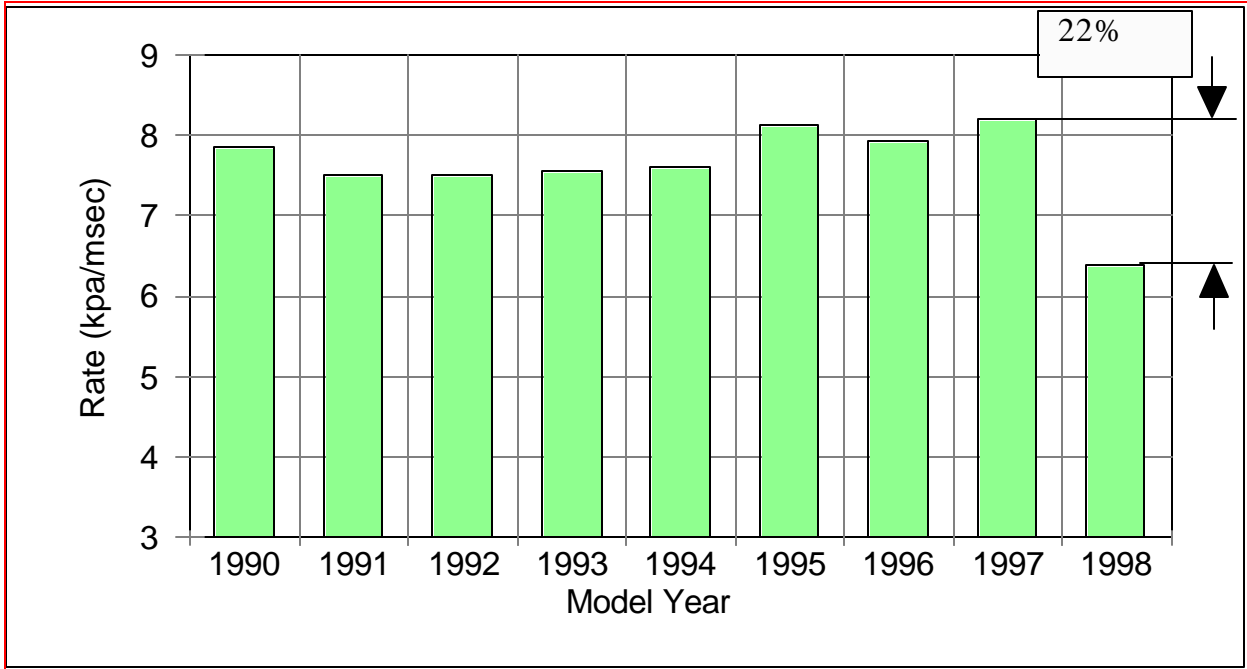

Figure 5. Weighted Average Adjusted Driver Air Bag Inflator Rise Rate, by Model Year.

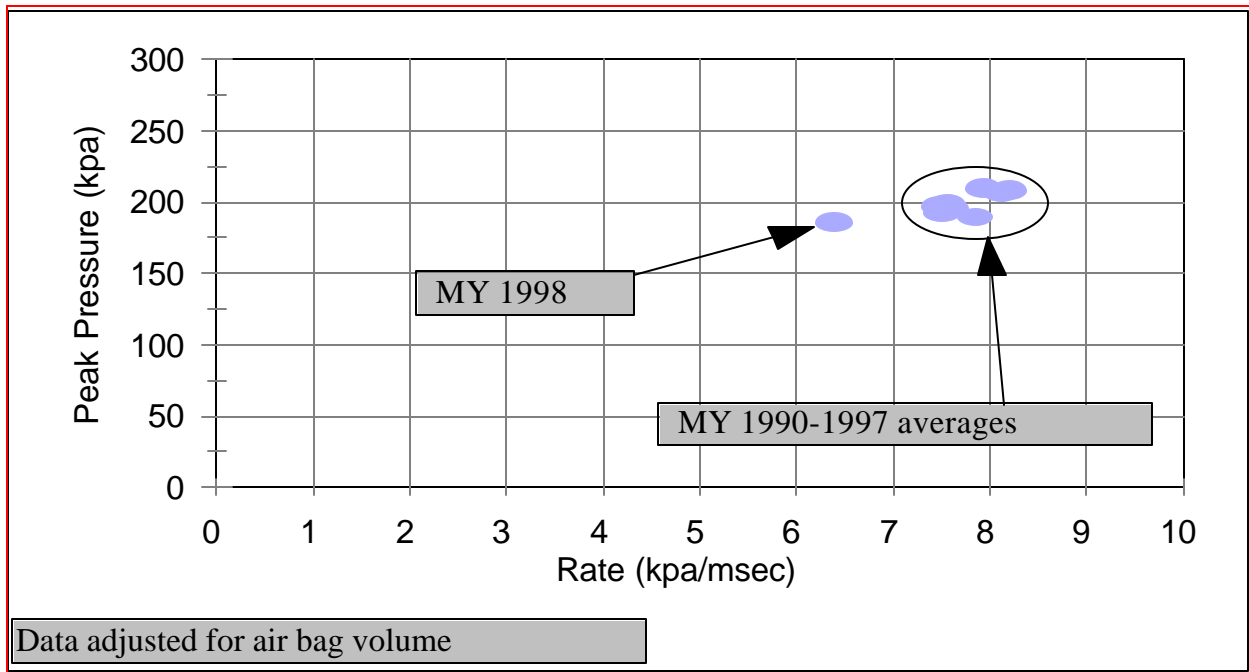

Figure 6. Weighted Average Adjusted Driver Air Bag Inflator Data.

Figure 6 shows a distinct clustering of the MY 1990 through 1997 IR Fleet vehicles. The MY 1998 data show that the IR Fleet has a lower average rise rate and average peak pressure. This trend is shown in Table 2 where the MY 1997 vehicles are compared to the MY 1998 vehicles.

Table 2. Trend Data for Weighted Average Adjusted Driver Air Bag Inflator Peak Pressure and Rise Rate.			
Data Type	MY 1997 vehicles	MY 1998 vehicles	Percent change
Peak Pressure	208 kpa	186 kpa	11%
Rise Rate	8.2 kpa/msec	6.4 kpa/msec	22%

100 kpa = 14.7 psi = 1 atmosphere

Figure 7 depicts the data presented in Table 2 in graphical form. Each line represents a composite pressure time history of the vehicles in the IR fleet for the two model years. The variation in rate of inflation (rise rate) is shown by the change in slope in the first portion of the curves.

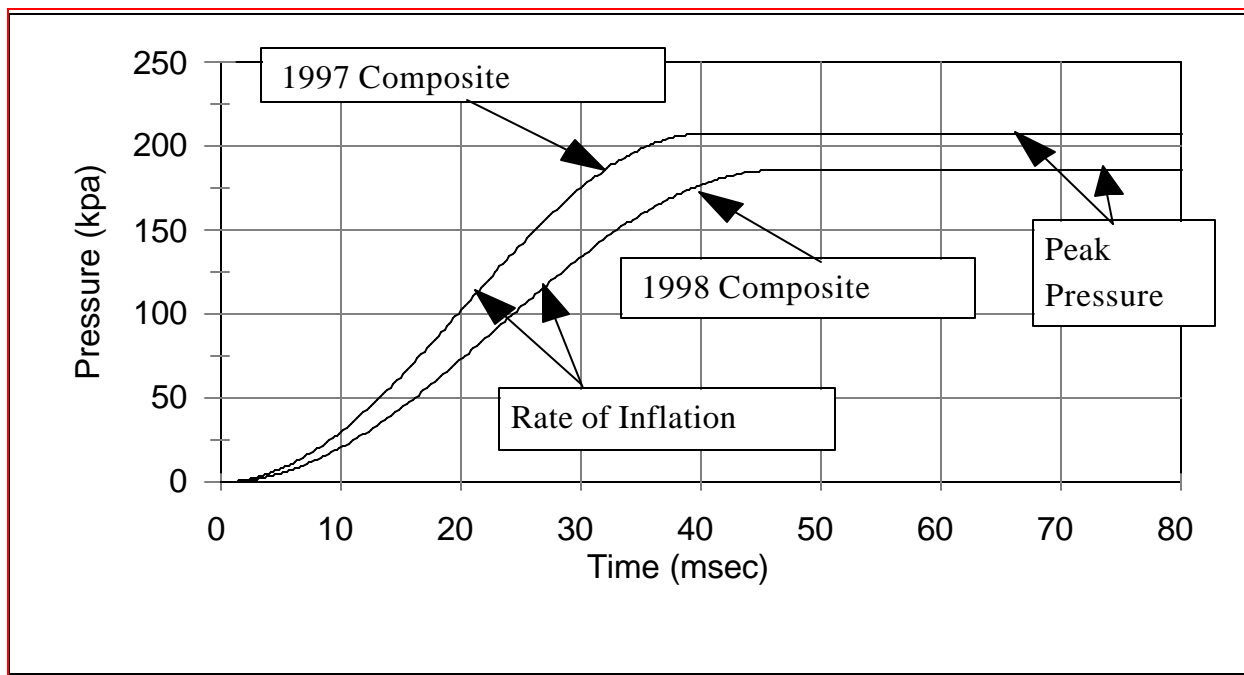

Figure 7 Graphical Representation of Weighted Average Adjusted Driver Air Bag Inflator Output for IR Fleet Comparing MY 1997 to MY 1998.

Another way to look at the change in adjusted pressure and rise rate data is by segmenting the vehicles into three categories: 1) those which increased peak pressure or rise rate, i.e., the adjusted peak pressure or rise rate for MY 1998 was higher than that for MY 1997, 2) those which remained the same, i.e., having the same value for peak pressure or rise rate for MY 1998 as for MY 1997, and 3) those which decreased these same parameters, i.e., the average air bag peak pressure or rise rate dropped from MY 1997 to MY 1998. This analysis is a pair analysis, hence only those vehicles which were manufactured both in MY 1997 and 1998 are considered. Figure 8 presents this data, which shows that while the majority of the MY 1998 vehicles were designed with a lower air bag inflator output (measured as peak pressure or rise rate) than their MY 1997 equivalent, approximately one third of the vehicles had no change, and some vehicles increased these parameters.

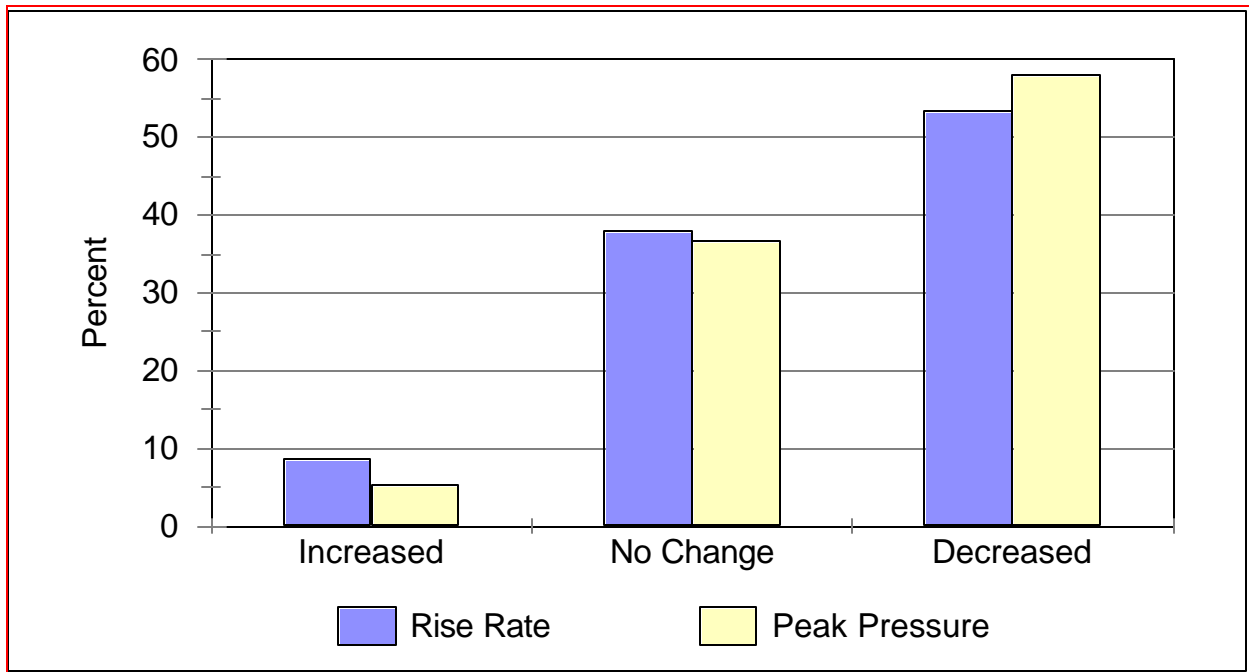

Figure 8. Adjusted Driver Air Bag Inflator Characteristics, by Direction of Change in Rise Rate and Peak Pressure.

Figures 9 and 10 show the frequency distribution of air bags in a 3-dimensional format with the adjusted rise rate and peak pressure being shown on the x and y axes, for MYs 1997 and 1998, respectively. The vertical height of the bars indicate the number of vehicles with each combination of adjusted peak pressure and rise rate.

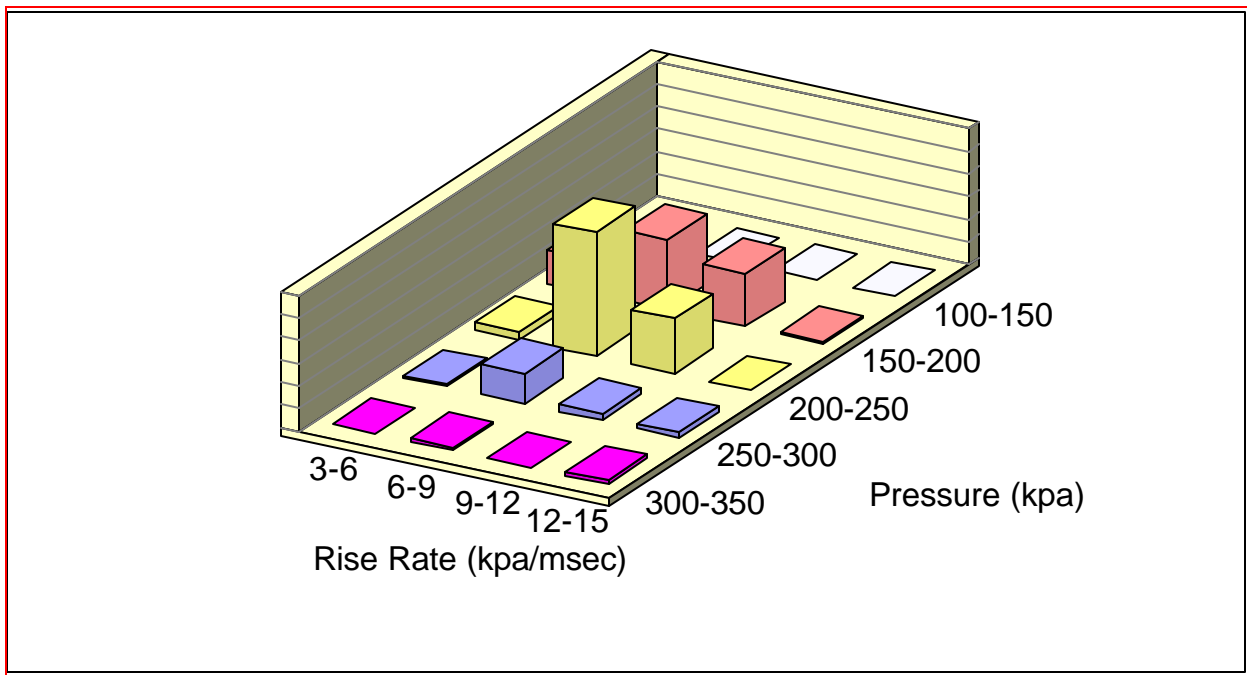

Figure 9. Frequency Distribution Plot showing Concentration Areas for Rise Rate and Peak Pressure, Adjusted Driver Air Bag Inflator Output, MY 1997.

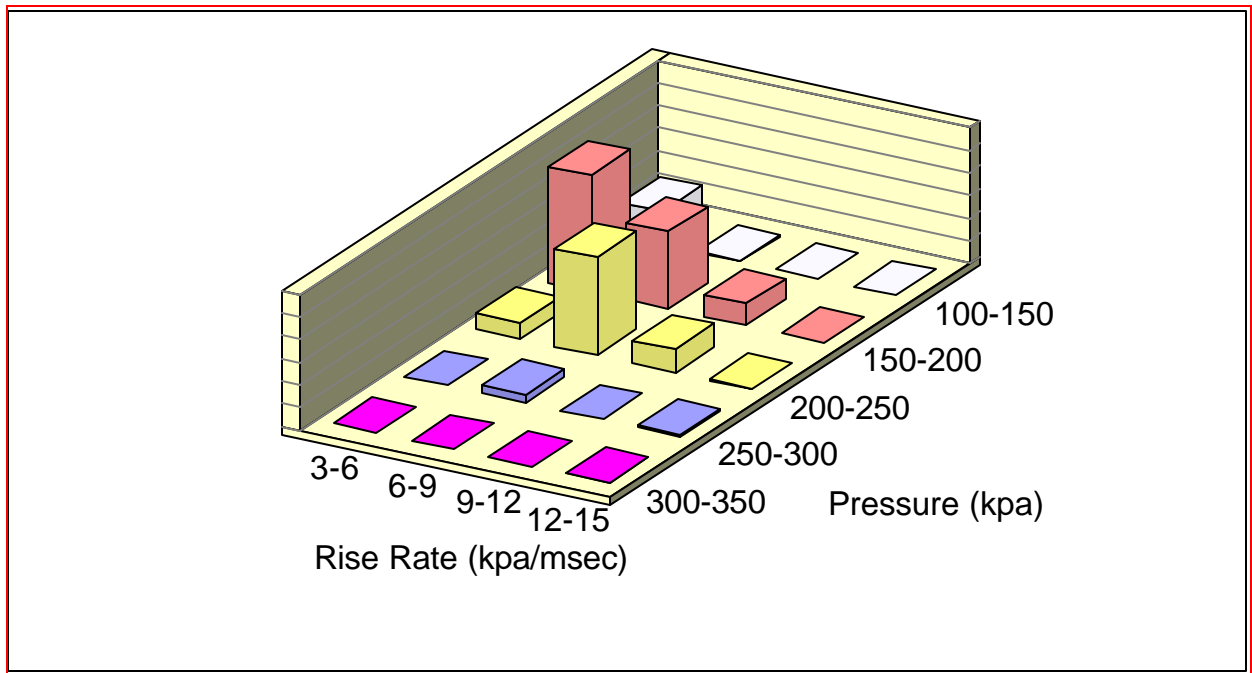

Figure 10. Frequency Distribution Plot showing Concentration Areas for Rise Rate and Peak Pressure, Adjusted Driver Air Bag Inflator Output, MY 1998.

Figures 9 and 10 confirm that there has been a general shift toward lower adjusted peak pressure and rise rate in MY 1998 vehicles, compared to MY 1997 vehicles.

3.4 Introduction of Passenger Air Bags in Fleet

Figure 11 shows the number of vehicles equipped with driver and passenger air bags in the IR fleet by model year. Passenger air bags were not installed in large numbers when air bags were first introduced in the early 1990's.

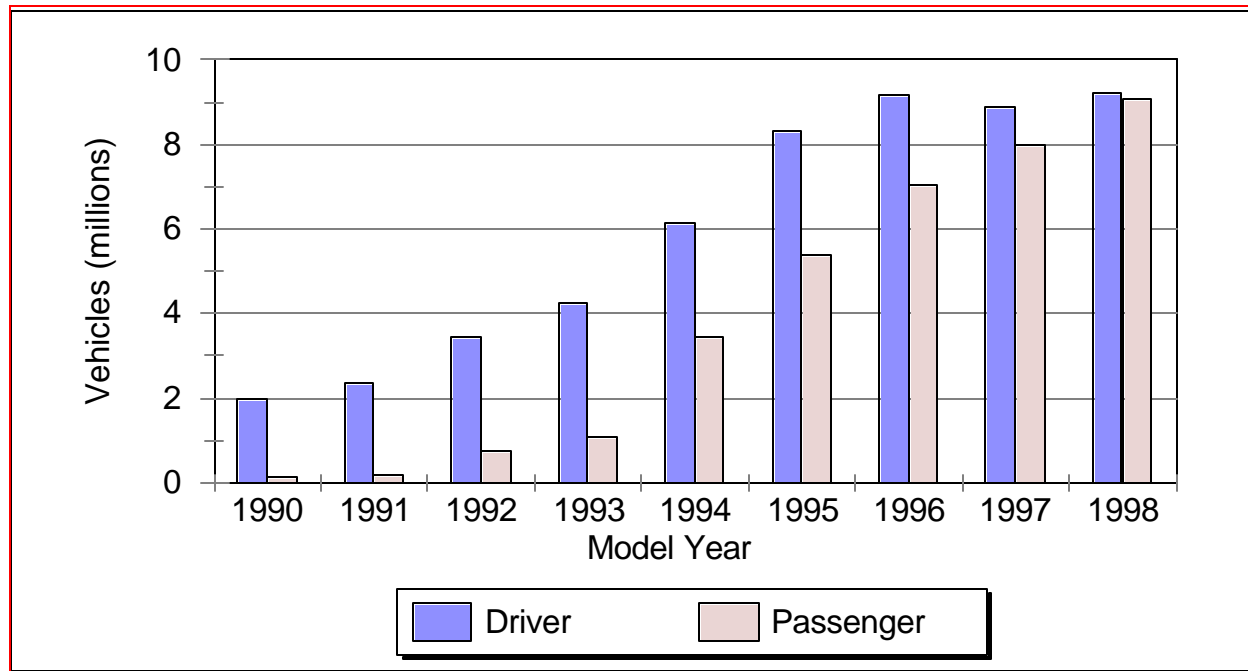

Figure 11. Vehicles in the IR Fleet with Driver or Passenger Air Bags, by Model Year.

Figure 12 presents the number of light trucks and vans (LTV) equipped with passenger air bags. Review of this figure shows the rate of change in the number of passenger air bags installed in LTVs was very high, on average increasing by about 1,000,000 trucks per year between MY 1995 and MY 1998.

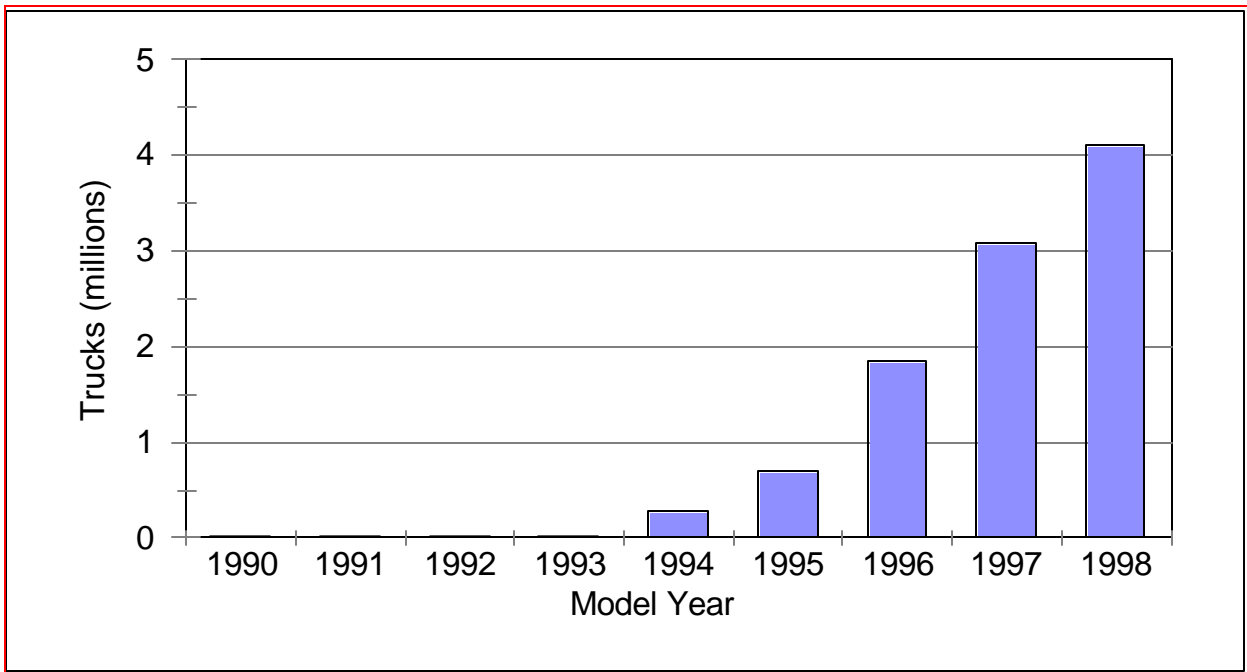

Figure 12. LTVs in the IR Fleet with Passenger Air Bags, by Model Year.

These two data sets (passenger air bags in general and LTVs with passenger air bags) are presented to give the reader some context in reviewing the passenger air bag data. These analyses reflect the manufacturers' IR submissions for each model year, hence they include all vehicles reported by the manufacturers. With the analysis presented in this report utilizing model year averages to establish trends, there is a possibility that these two trends could confound other data trends, as follows:

- 1) During the first few years covered by the IR, there were relatively few vehicles equipped with passenger air bags compared to the later years. Additionally, only two manufacturers offered these devices in the first year or two. To remove possible biases in the trend analysis, NHTSA only analyzed the later portion of the IR data in the analyses in this section, MYs 1994 through 1998, to obtain passenger air bag inflator characteristics.
- 2) Additionally, there were no LTVs in the IR fleet equipped with passenger air bags until MY 1994. LTVs are generally larger than passenger cars, hence they may have different occupant protection design characteristics, particularly on the passenger side. These characteristics could have as much or more of an effect on the IR Fleet trends as emerging technology has had.

3.5 Passenger Air Bag Analysis

A similar analysis as that performed on the driver air bags was conducted to quantify the passenger air bag inflator output characteristics. Figures 13 and 14 shows the average weighted adjusted data for the passenger air bag inflator output for both the peak pressure and rise rate.

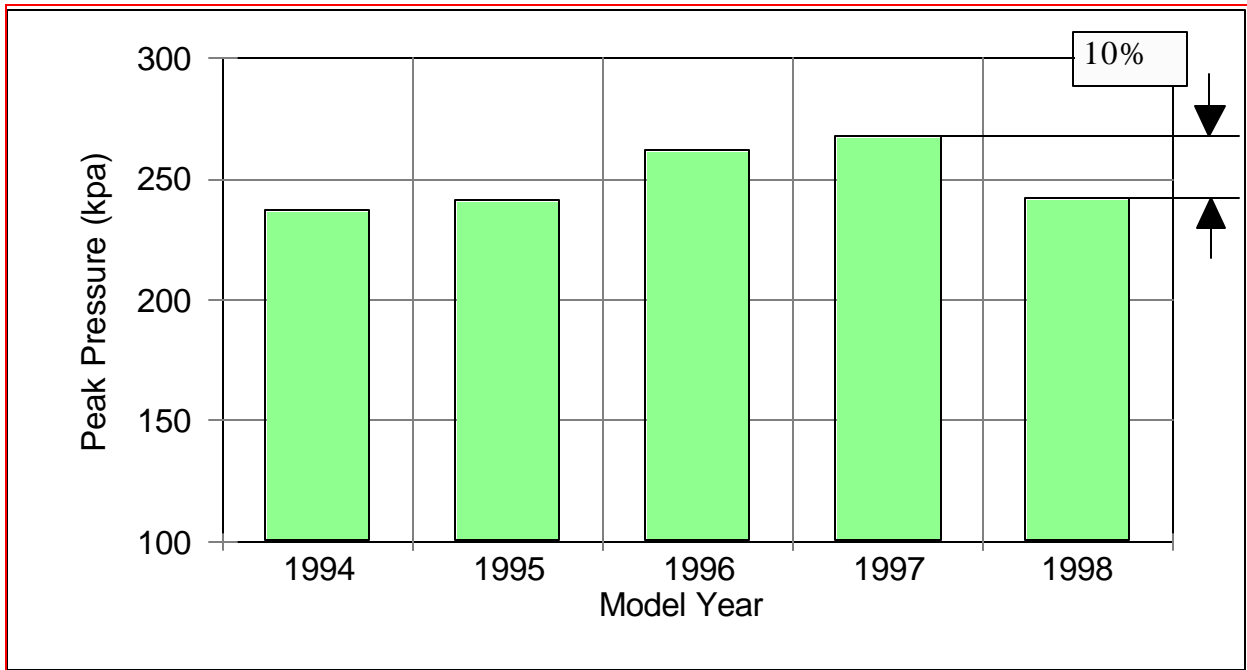

Figure 13. Weighted Average Adjusted Passenger Air Bag Inflator Peak Pressure, by Model Year.

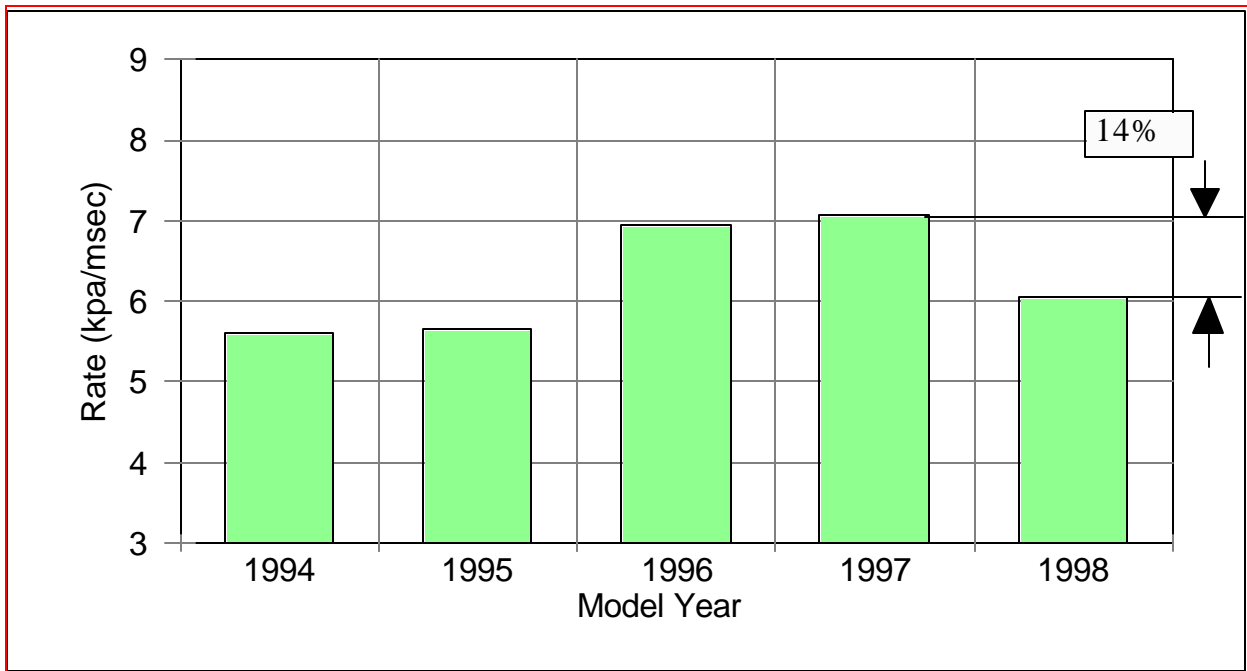

Figure 14. Weighted Average Adjusted Passenger Air Bag Inflator Rise Rate, by Model Year.

As shown in Figure 13, the average peak pressure rose steadily until MY 1997, after which it dropped significantly, about 10 percent. A similar trend is seen in the average adjusted rise rate data shown in

Figure 14.

The composite plot is shown in Figure 15. Here the distinct trend observed in the more mature driver air bag systems is not seen, except when comparing the MY 1996 and 1997 IR Fleet vehicles to the MY 1998 IR Fleet vehicles.

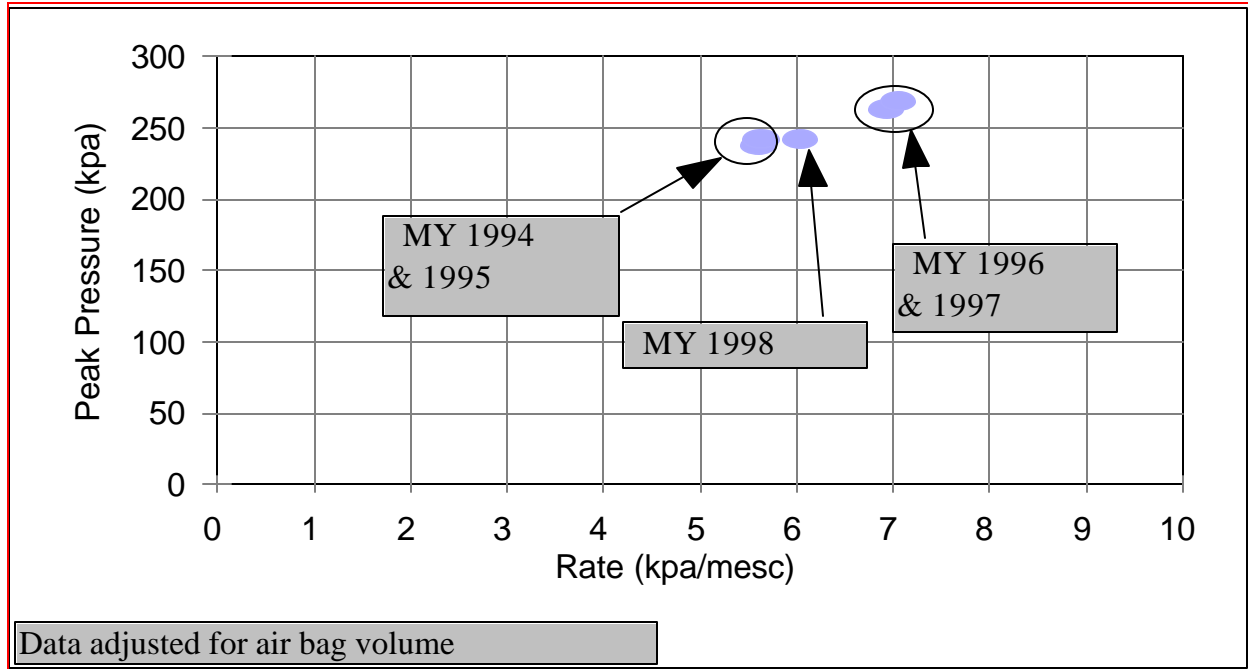

Figure 15. Weighted Average Adjusted Passenger Air Bag Inflator Data.

Trend data comparing the MY 1997 vehicles to the MY 1998 vehicles are shown in Table 3.

Table 3. Trend Data for Weighted Average Adjusted Passenger Air Bag Inflator Peak Pressure and Rise Rate.			
Data Type	MY 1997 vehicles	MY 1998 vehicles	Percent change
Peak Pressure	268	242	10%
Rise Rate	7.1	6.1	14%

100 kpa = 14.7 psi = 1 atmosphere

Figure 16 presents a graphical representation of the rise rate and peak pressure for the passenger side.

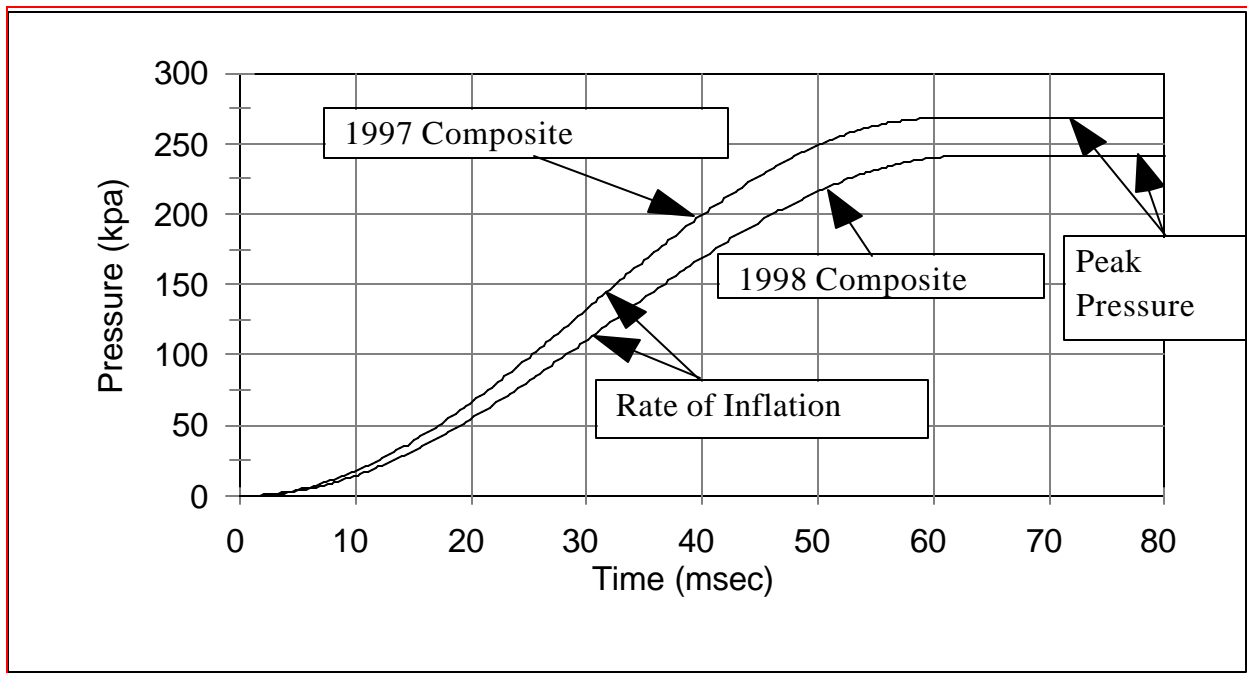

Figure 16. Graphical Representation of Average Adjusted Passenger Air Bag Inflator Output for IR Fleet Comparing MY 1997 to MY 1998.

The change in pressure and pressure rise rate for the passenger air bag inflators is shown in Figure 17. The plot indicates about 10 to 15 percent of the vehicles were equipped with passenger air bags with “increased” rise rate or peak pressure, while the remainder were split roughly equally between “no-change” or “decreased” rise rate and/or peak pressure.

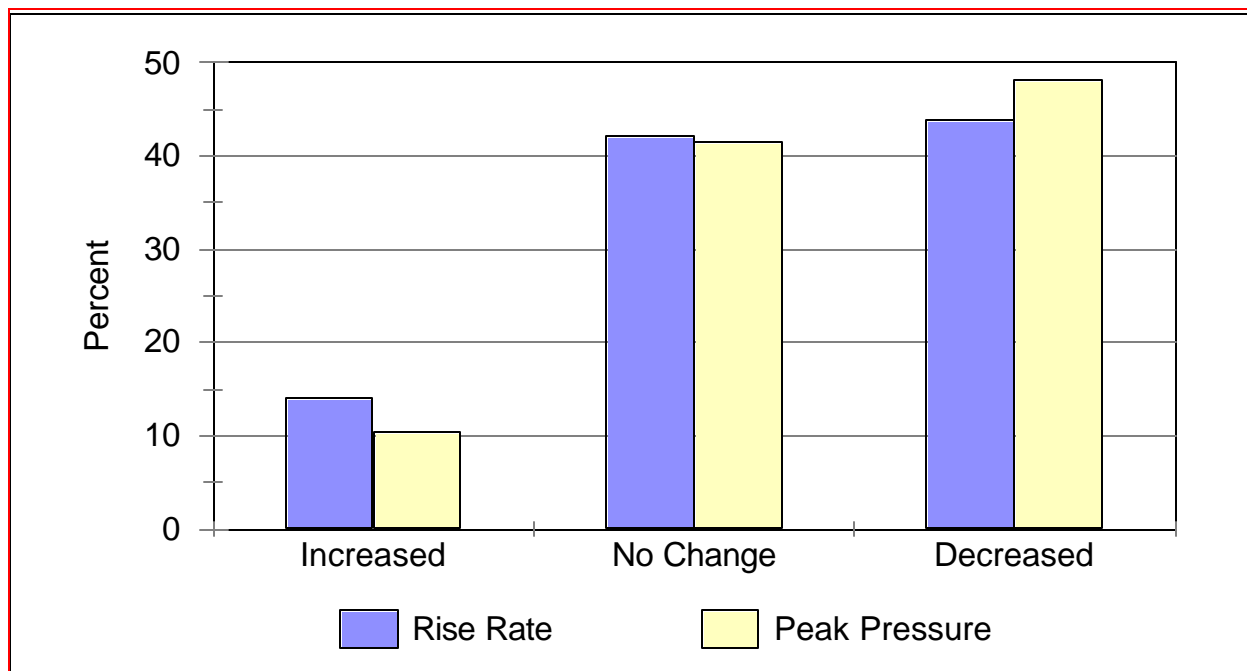

Figure 17. Adjusted Passenger-Side Air Bag Inflator Characteristics, by Direction of Change in Rise Rate and Peak Pressure.

The frequency distribution plots for the passenger air bags are found in Figures 18 and 19. As with the driver air bags, there is a distinct migration toward the lower values of peak pressure and rise rate when MY 1997 and 1998 vehicles are compared.

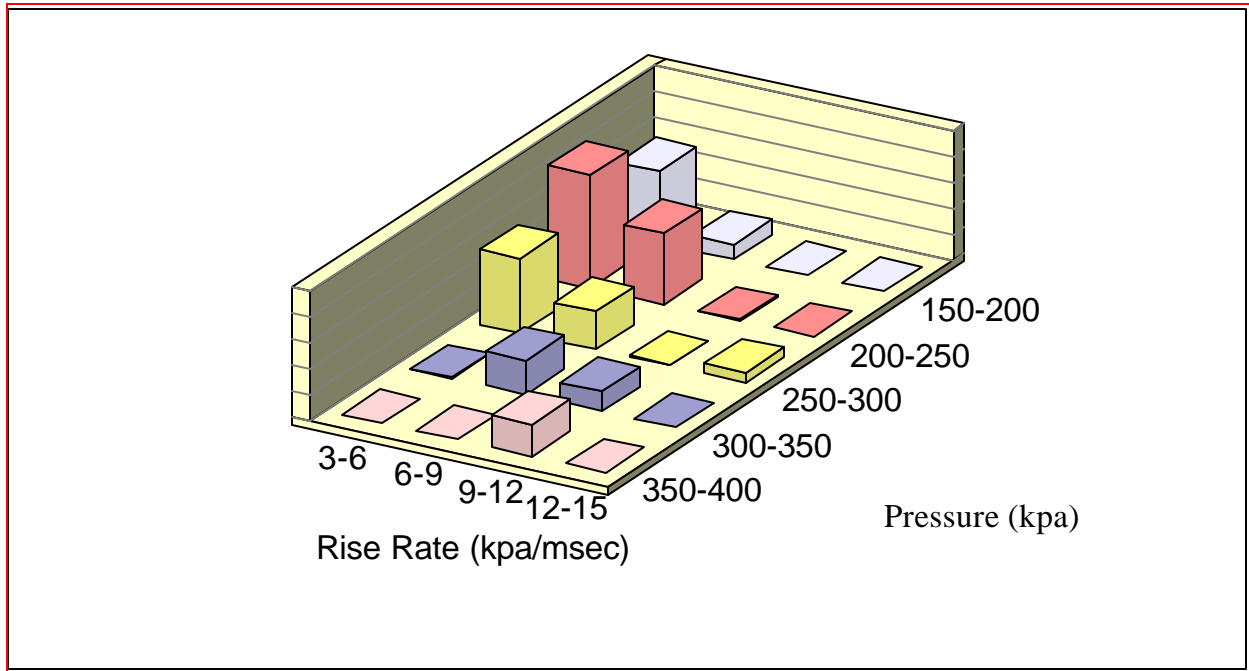

Figure 18. Frequency Distribution Plot showing Concentration Areas for Average Rise Rate and Peak Pressure, Adjusted Passenger Air Bag Inflator Output, MY 1997.

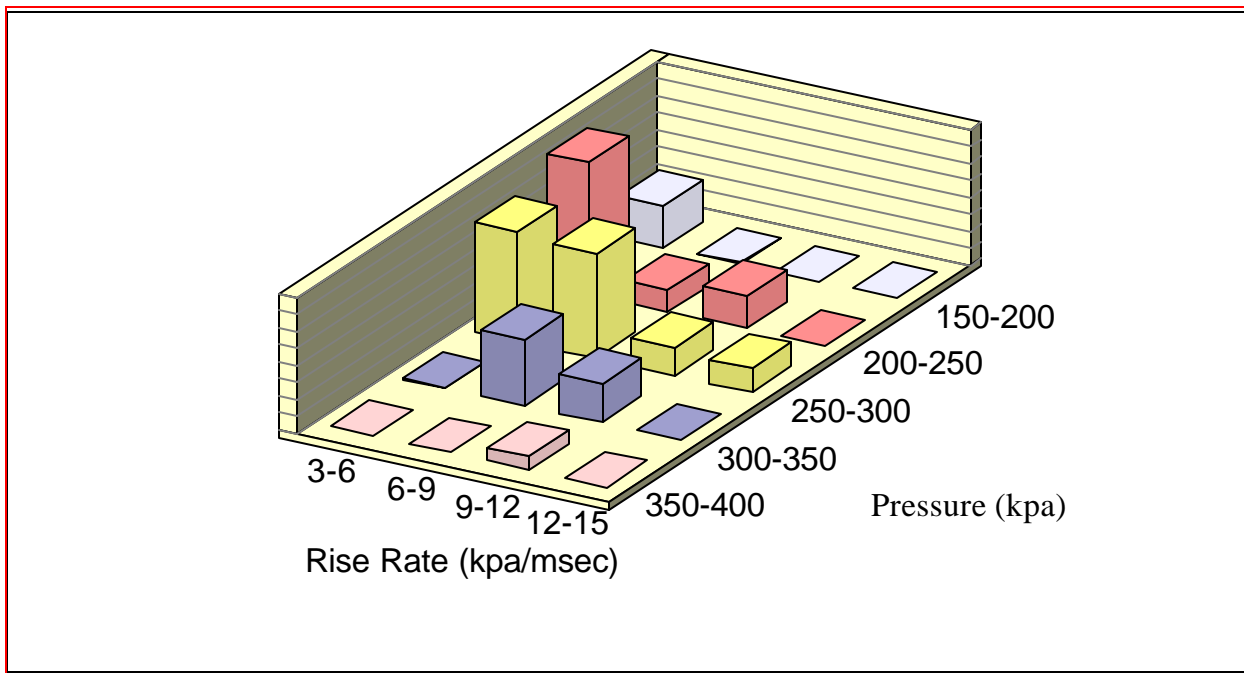

Figure 19. Frequency Distribution Plot showing Concentration Areas for Average Rise Rate and Peak Pressure, Adjusted Passenger Air Bag Inflator Output, MY 1998.

4.0 Air Bag Performance in Late Model Passenger Vehicles

4.1 NHTSA's Out-of Position Testing

To evaluate the potential adverse effects of air bag deployment, NHTSA conducted out-of-position tests with different sized dummies using both driver and passenger air bag systems. For the evaluation of driver air bags, 5th percentile female dummies were tested in two different positions. For the evaluation of passenger air bags, 6-year-old child dummies also were tested in two different positions. (See Appendix D for reference data, discussion of the rationale, and dummy setup for the out-of-position testing.) The two positions used on each side were intended to provide air bag loadings to the chest and to the head/neck complex, the body regions in which severe and fatal injuries have been observed in the real world crashes. Since these tests represent the worst case scenarios involving air bag deployments, dummy measurements were expected to be relatively high.

4.1.1 Driver Air Bag Testing

Results from the 5th percentile female dummy tests using MY 1996, 1998 and 1999 air bag systems are found in Appendix D in Tables D-1 and D-2. For both Position 1 and 2 configurations, the test results indicate that each of the tested vehicles met the injury assessment reference value (IARV³) for the head

³ IARVs are shown in two formats, engineering units and normalized. In the normalized format, the IARV is divided by the reference value for the particular criteria, hence a value of 1 would represent the maximum acceptable level.

injury criterion, the chest acceleration, and the chest deflection. The IARV for the neck injury criterion (shown as N_{ij} in the Tables in Appendix D) was exceeded in both Position 1 and 2 testing. Tables 4 and 5 summarize these data. It is noted that the average neck injury measurement decreased with each model year.

Table 4. Neck Injury Data for Out-of-Position Testing for Position 1, by Model Year.			
Vehicle Model Year	Vehicles Exceeding the Neck Injury Reference Value out of the Number Tested	Percent	Average Neck Injury Measurement
1996	3 of 4	75	1.66
1998	5 of 5	100	1.44
1999	2 of 6	33	0.90

Table 5. Neck Injury Data for Out-of-Position Testing for Position 2, by Model Year.			
Vehicle Model Year	Vehicles Exceeding the Neck Injury Reference Value out of the Number Tested	Percent	Average Neck Injury Measurement
1996	3 of 4	75	1.60
1998	5 of 5	100	0.83
1999	0 of 6	0	0.47

As with position 1, the average neck injury measurement decreased with each model year in position 2. Figure 20 presents these data graphically.

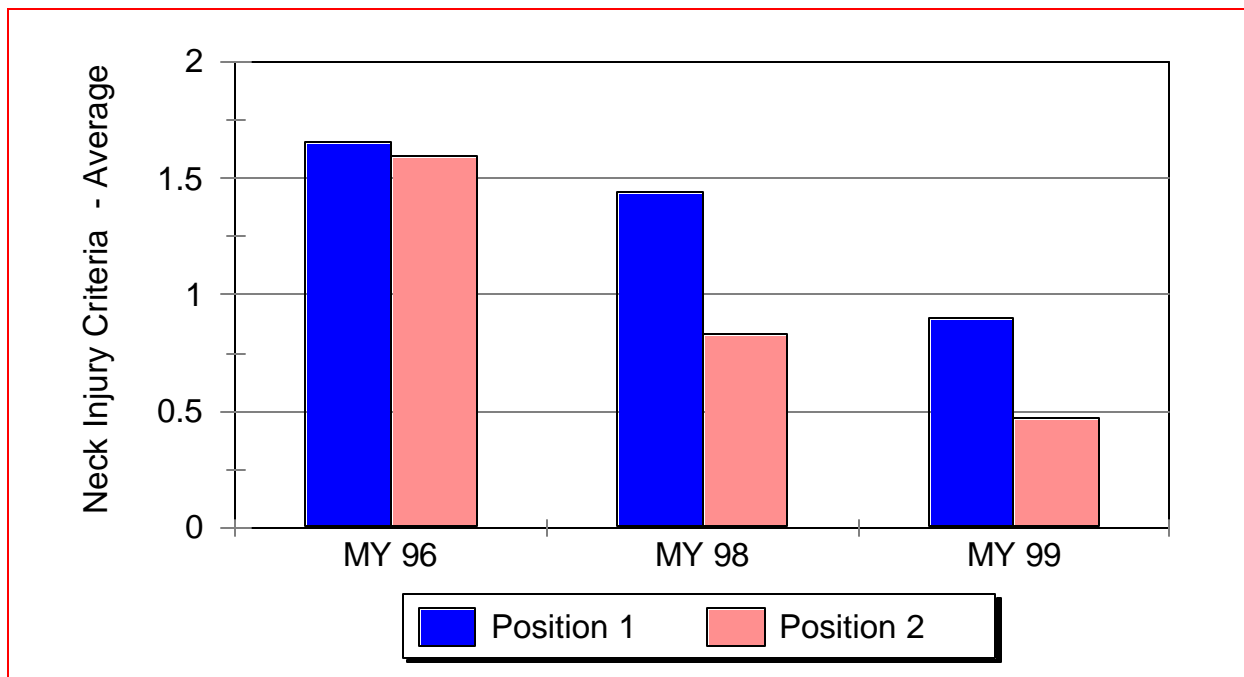

Figure 20. Average Test Results for Neck Injury Measurements for Driver Out-of-Position Testing with 5th Percentile Female Dummy.

4.1.2 Passenger Air Bag Testing

Results from the 6-year-old child dummy tests using MY 1996, 1998 and 1999 air bag systems are found in Appendix D in Table D-3. For the Position 1 test configuration, the results indicate that the head injury criterion, the neck injury criterion, the chest acceleration, and the chest deflection measurements exceeded the IARV in some of the tested vehicles. The average injury measurement for the head injury criterion, neck injury criterion, the chest acceleration, and chest deflection decreased with the newer model year vehicles. These data are depicted in Figure 21. Position 2 data are not presented here since Position 2 tests were only conducted for MY 1999 vehicles.

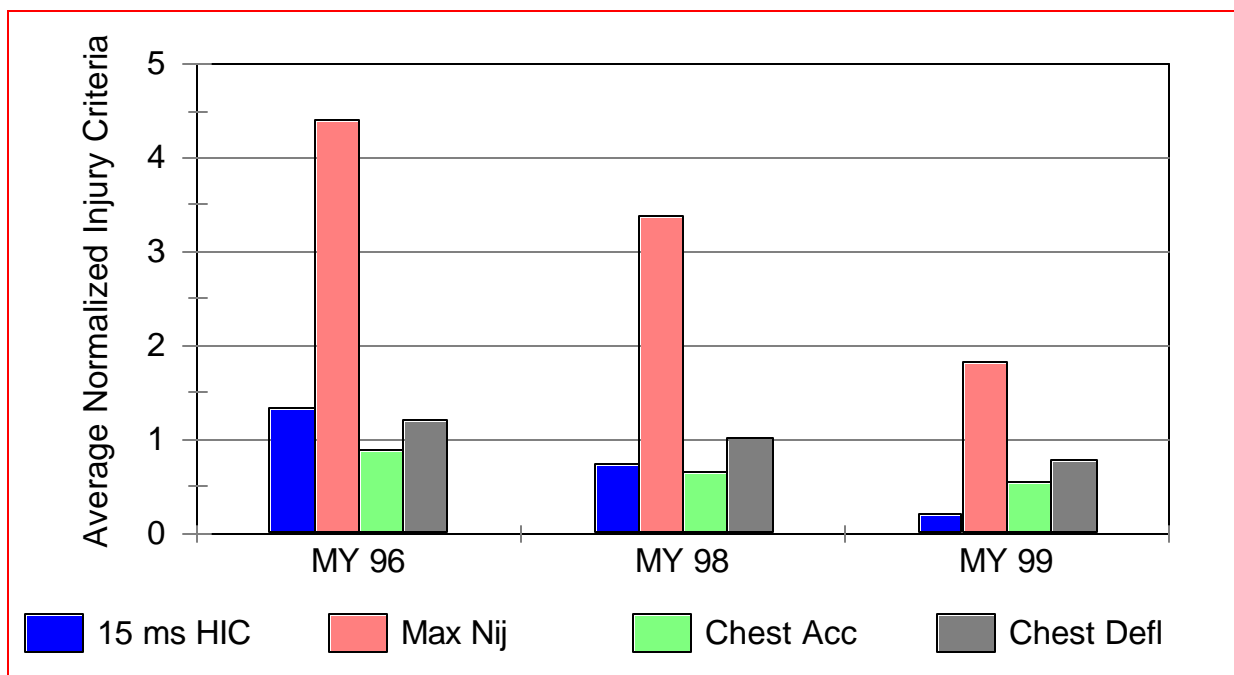

Figure 21. Average Normalized Injury Criteria for Passenger Out-of-Position Testing with 6-Year-Old Child Dummy–Position 1.

4.1.3 Two-Stage Air Bag Testing

The 1999 Acura RL, which has dual-stage passenger air bag, was tested in the Positions 1 and 2 in two ways: (1) firing only the first stage and (2) firing the both stages with a 40 ms delay between the two stages. Position 2 data are presented in Table D-4.

	Position 1	Position 2
First Stage Only	0.91	0.83
First Stage followed by Second Stage after 40 msec Delay	1.26	0.94

Thus, the first stage Acura RL was the only passenger air bag system which passed the neck injury criteria in both test configurations.

4.1.4 Distance From the Air Bag Testing

In addition to the aforementioned out-of-position testing, additional testing was undertaken to quantify the effect of proximity of the dummy to the passenger air bag module on neck injury. A series of tests were run using a modified Position 1 configuration. The modification entailed the placement of the 6-year-old child dummy four and eight inches away from the air bag. These tests were conducted on MY 1996 and 1998 air bag systems. The results are shown in Table D-3. While most of the tested systems exceeded the IARVs for clearances of zero and four inches, a large majority met the

requirements with eight inches clearance. Also, the average of each of the injury measures decreased as the distance away from the module increased. These data demonstrate that with the newer technology, occupants can be closer to the air bag without being subjected to increased risk of injury. Figures 22 through 25 present these data graphically.

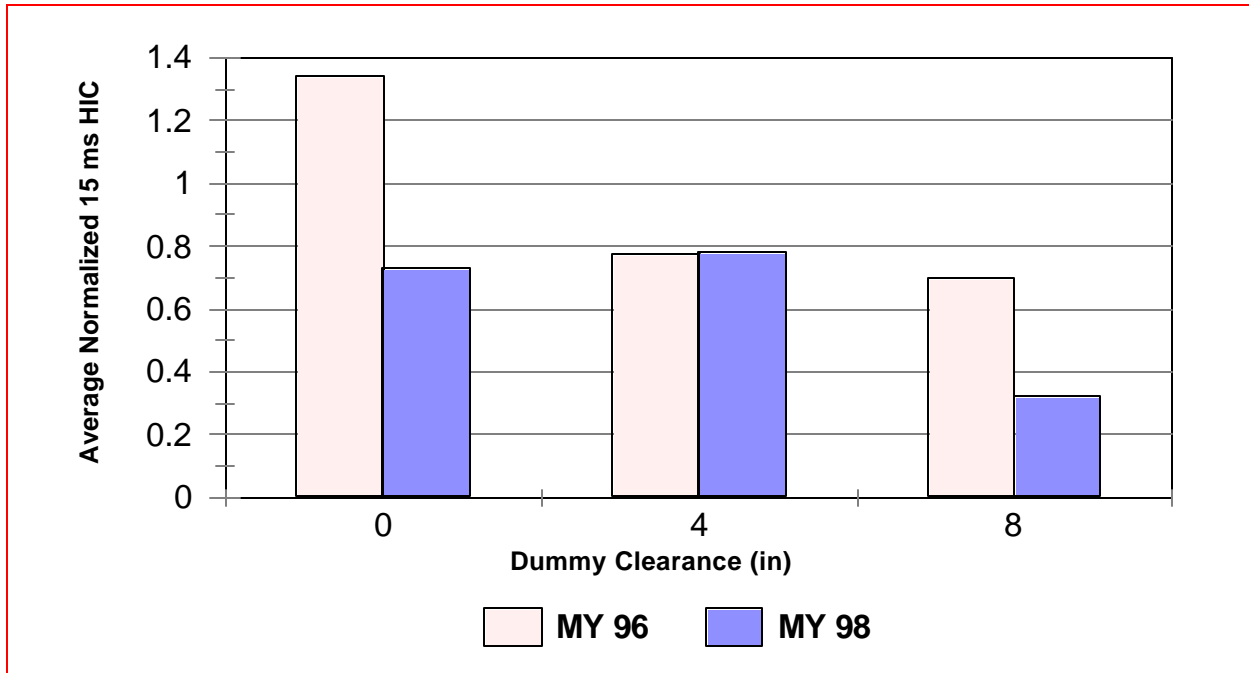

Figure 22. Average Normalized HIC 15 msec for Passenger Out-of-Position Testing with 6-Year-Old Child Dummy–Position 1 at Various Clearances.

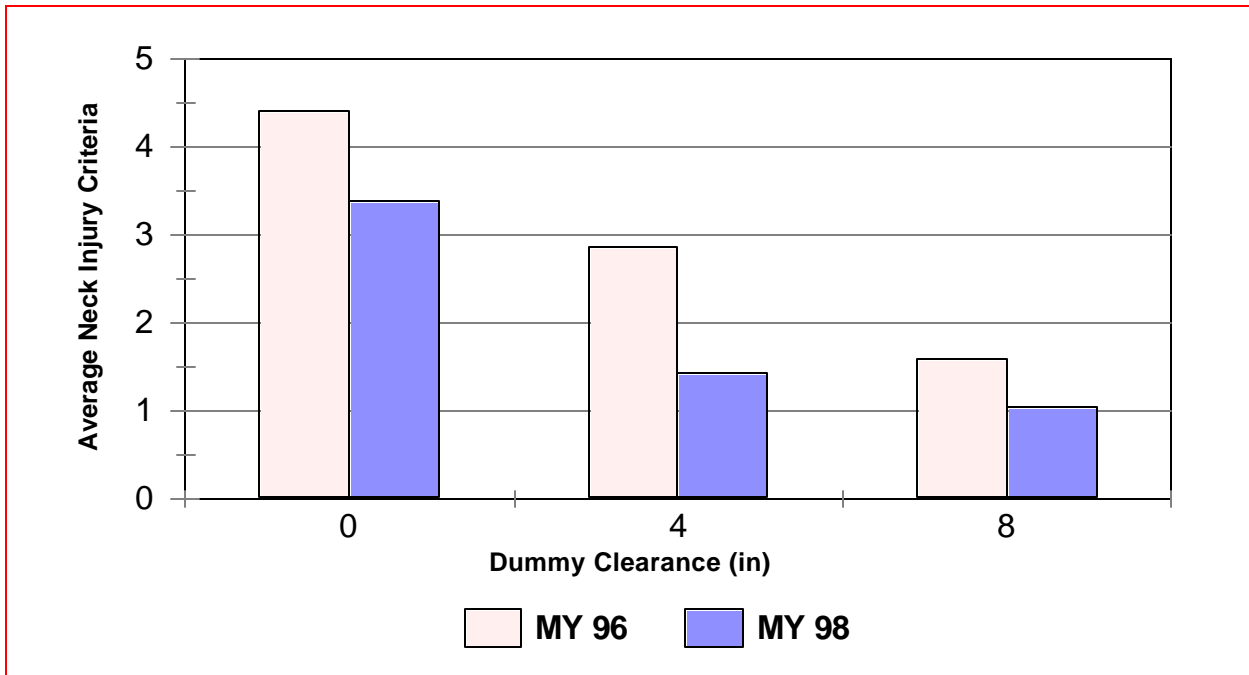

Figure 23. Average Normalized Neck Criteria for Passenger Out-of-Position Testing with 6-Year-Old Child Dummy–Position 1 at Various Clearances.

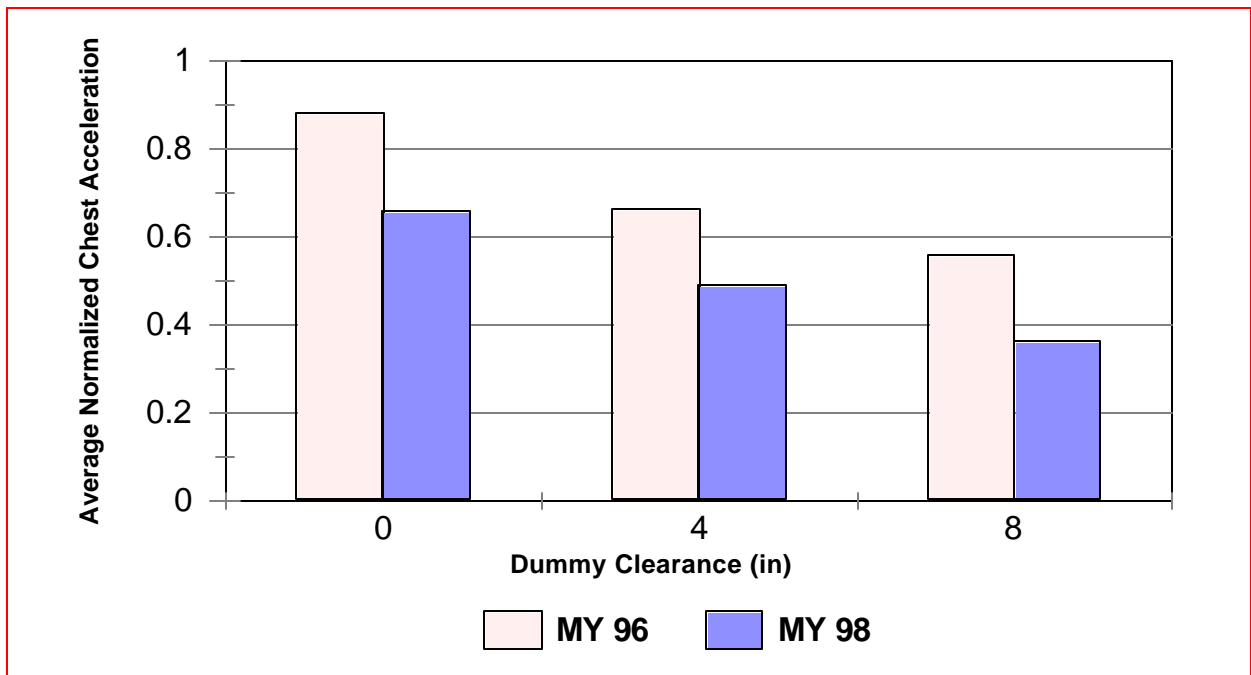

Figure 24. Average Normalized Chest Acceleration for Passenger Out-of-Position Testing with 6-Year-Old Child Dummy–Position 1 at Various Clearances.

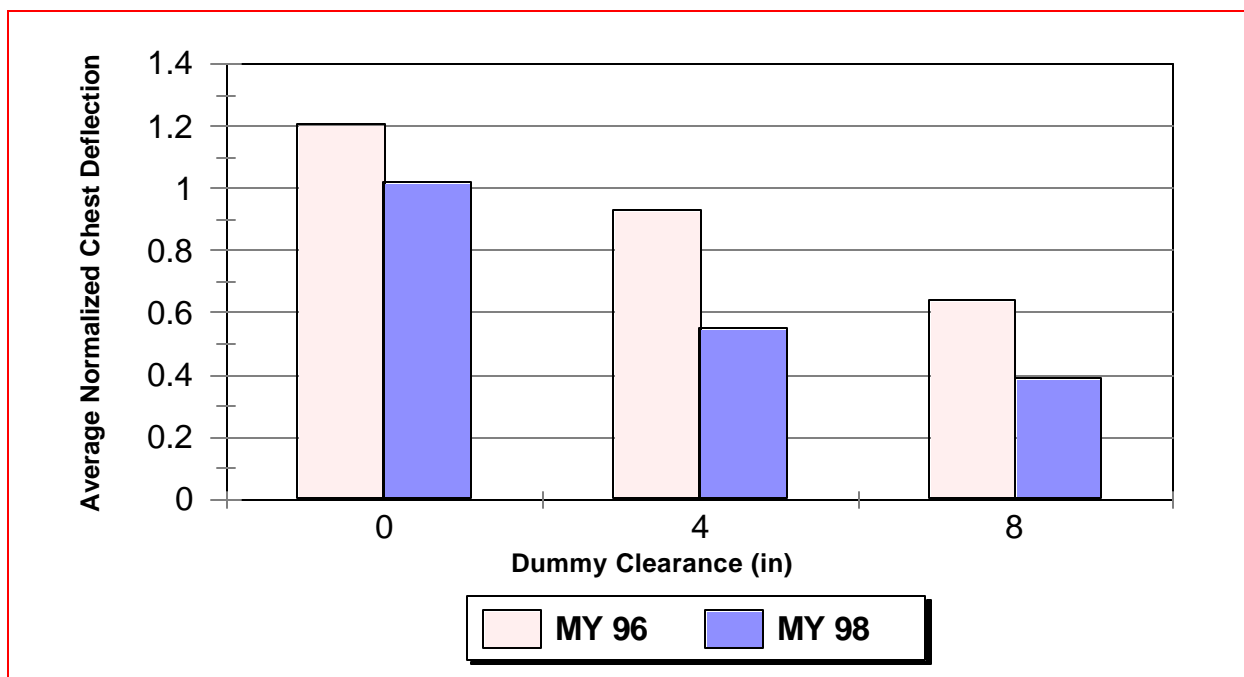

Figure 25. Average Normalized Chest Deflection for Passenger Out-of-Position Testing with 6-Year-Old Child Dummy–Position 1 at Various Clearances.

4.2 Performance of New Model Vehicles with Redesigned Air Bag Systems in Rigid Barrier Tests

In 1997, the generic sled test option was introduced as a temporary alternative to the rigid barrier test to allow automakers to rapidly install less aggressive air bags. To check the performance of these redesigned air bags high-speed crashes, NHTSA conducted a series of FMVSS No. 208 rigid barrier tests in thirteen MY 1998 and 1999 production vehicles with unbelted 50th percentile male dummies in the driver and right front passenger seating positions. Details on these tests are provided in Appendix D, including supporting data and graphical representations of the injury criteria.

The injury measures obtained from these 13 tests for each seating position were normalized and averaged by model years. These are shown in Figures 26 and 27, driver and passenger data, respectively. Included for comparison are a set of equivalent vehicles from pre-98 model years. The pre-98 vehicle set is comprised of the same vehicles as the vehicles tested in the MY 1998 and MY 1999 program, with two exceptions. In MY 1998, there was not an equivalent model to the MY 1999 Acura RL and earlier versions of the Toyota Tacoma did not have a passenger side air bag. The pre-98 data came from NHTSA’s compliance crash test program. There were no Nij data for the older vehicles, because the dummies used in the tests of the pre-98 vehicles were not instrumented to measure neck injury measures.

The average injury measures in the MY 1998 and MY 1999 vehicles increased only slightly for most of the measures, and in some instances actually decreased. It is interesting to note that even though the MY 1998 and 1999 vehicles tested showed large improvement in out-of-position performance, these

same systems also performed very well overall in the 30 mph unbelted barrier test. Indeed, although there was some variation among the vehicles, the average values were no greater than 81 percent of the IARVs.

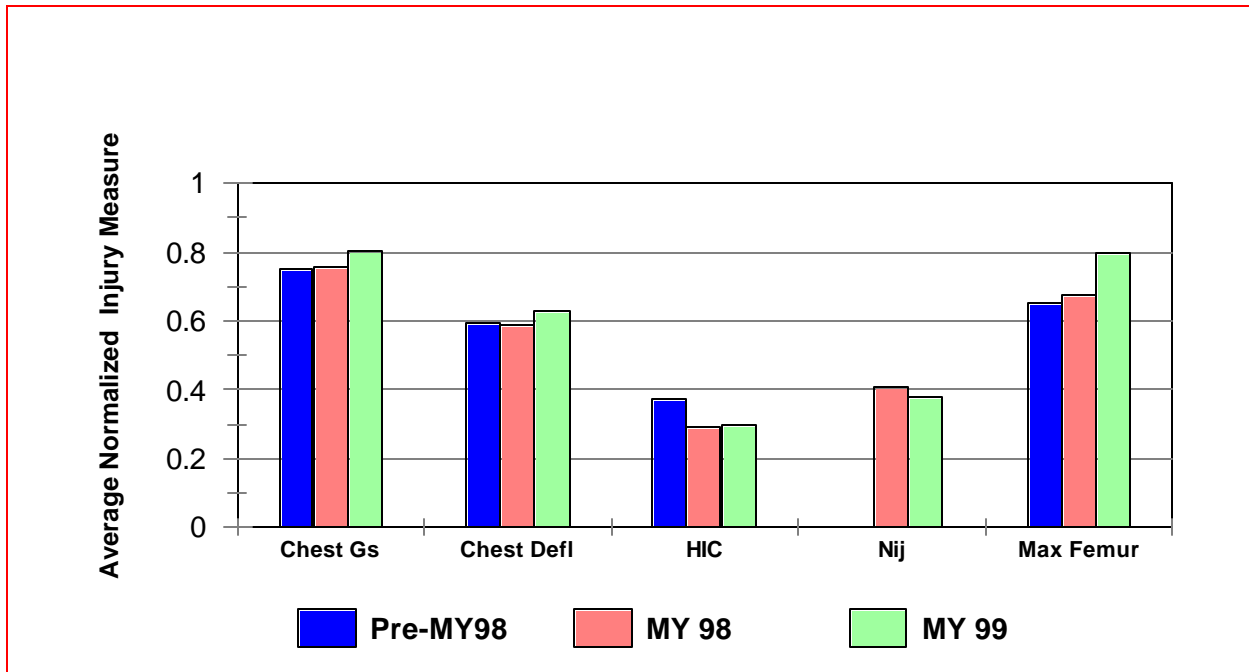

Figure 26. Driver Normalized Injury Measures in 30 mph Unbelted Barrier Tests.

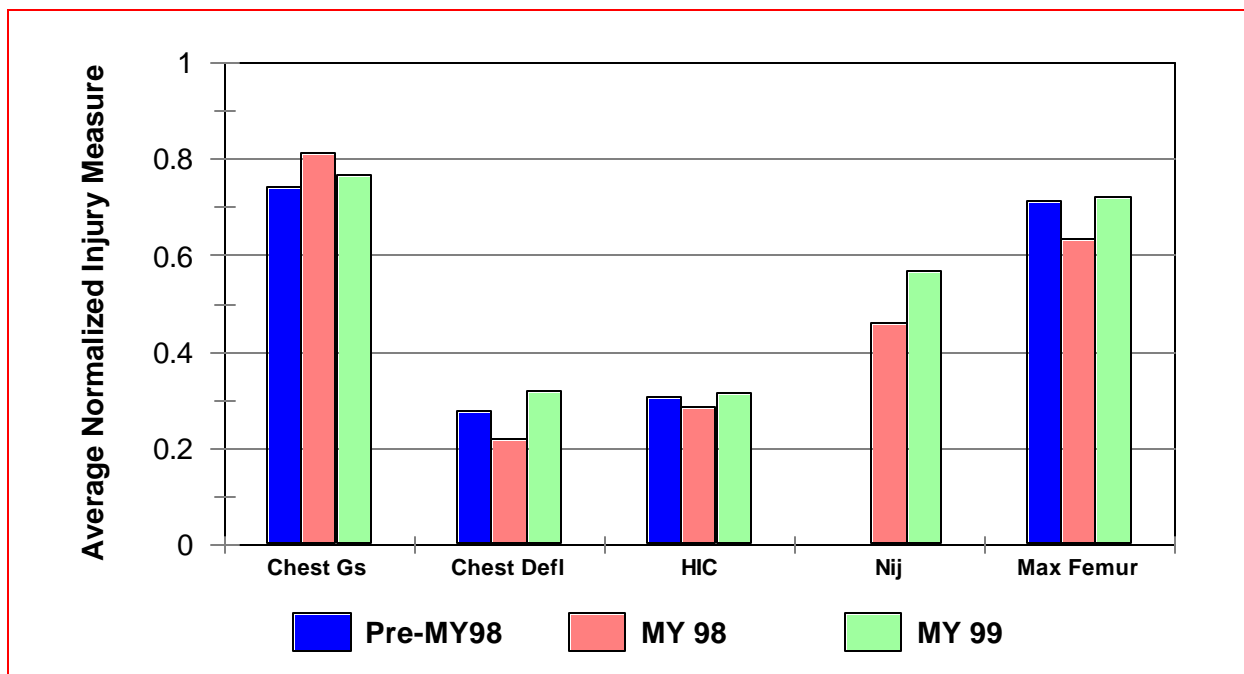

Figure 27. Right Front Passenger Normalized Injury Measures in 30 mph Unbelted Barrier Tests.

5.0 Discussion of Evolving Air Bag Fatality Trends Using SCI Data

As of September 1, 1999, NHTSA's Special Crash Investigations (SCI) Program has confirmed over 180 crashes involving air bag deployment-related fatalities and serious injuries. In addition, SCI is reviewing an additional 50 crashes. Included in the confirmed number are 83 fatal children injured by the deploying air bag, of which eighteen were in rear facing child safety seats.

NHTSA used R.L. Polk vehicle registration data to determine the number of new air bag-equipped passenger cars and light trucks registered in the United States for each model year. These registration counts are used to normalize the SCI fatality counts to obtain rate data, i.e., the number of air bag-related fatalities per million registered vehicle years (MRVY). This analysis includes MYs 1988 through 1999. The SCI fatality counts are based on confirmed and unconfirmed data. The majority of the SCI cases are confirmed within the same crash year; however, some cases are not located and confirmed for several years after the crash date. The supporting data for these figures is presented in Appendix E.

Figures 28 and 29 present the data for 12-month intervals for driver and passenger air bags. The data was calculated by dividing the SCI count of fatal crashes for each 12-month interval by the total number of registered vehicles with driver or passenger air bags during that same interval. Each 12-month interval was aligned with the vehicle production year, hence it starts in September and ends in August.

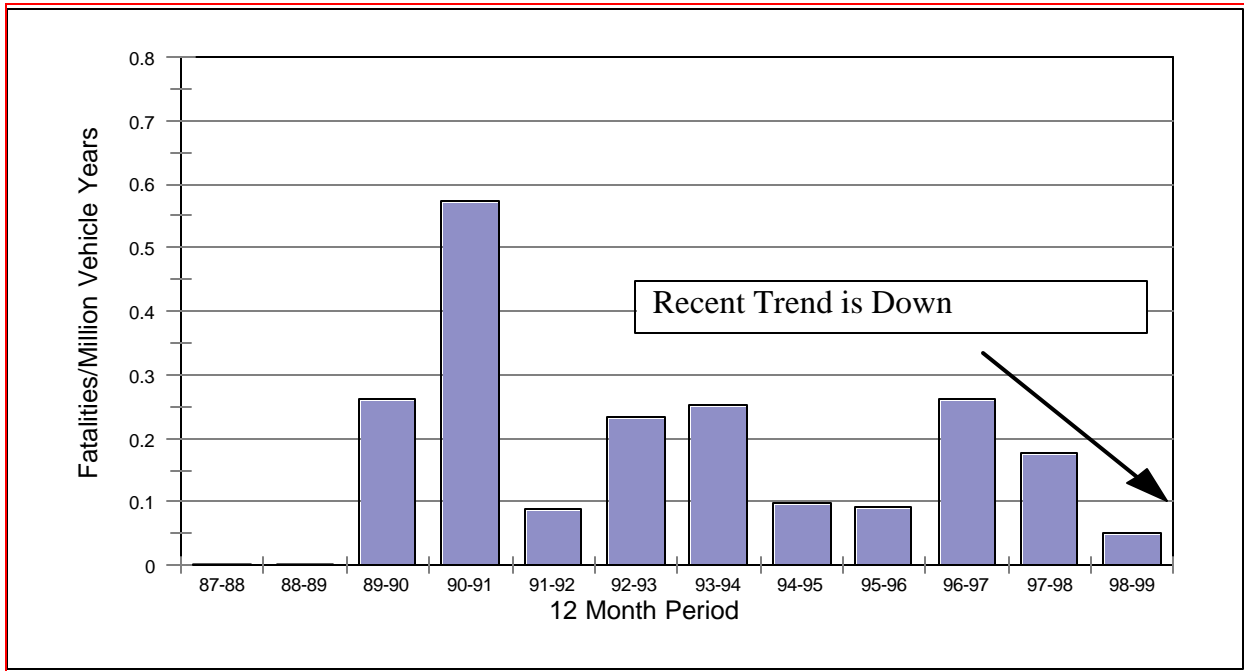

Figure 28. SCI Data for Fatal Drivers Normalized for Registrations of Vehicles with Driver Air Bags, by 12 Month Interval.

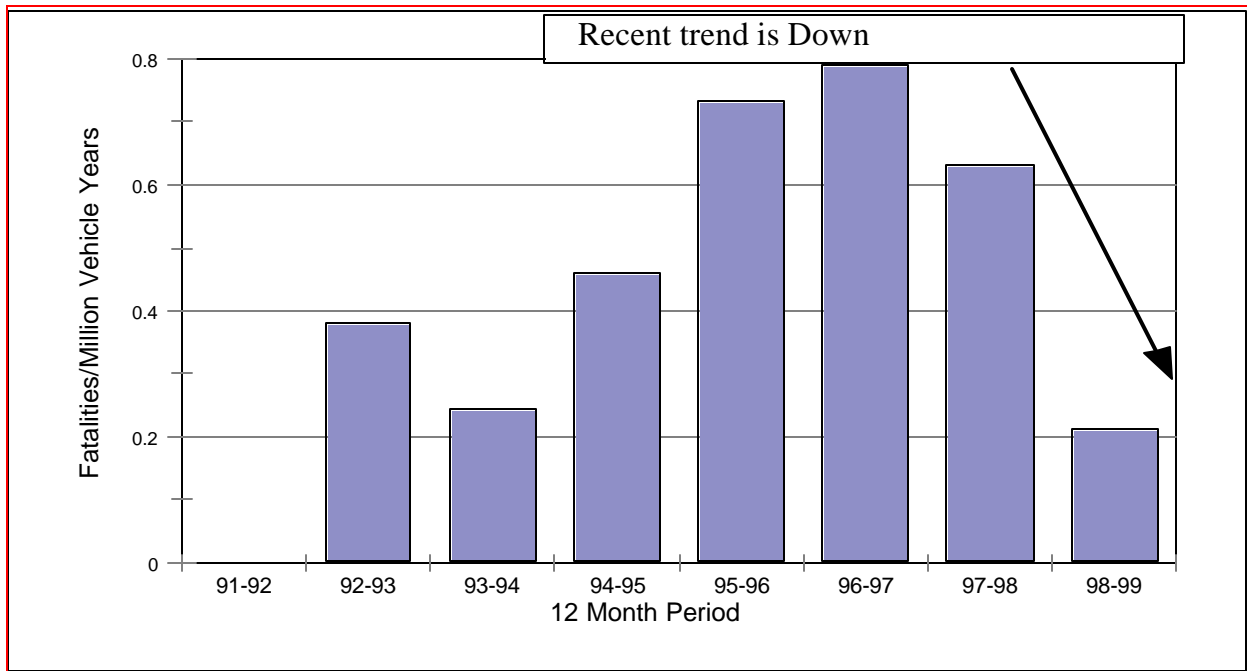

Figure 29. SCI Data for Fatal Passengers Normalized for Registrations of Vehicles with Passenger Air Bags, by 12 Month Interval.

With driver air bags, there has been a decrease in the fatality rate beginning in the 1996-1997 interval, dropping from 0.25 fatalities per MRVY to 0.05 fatalities per MRVY in the current period. Passenger

air bags have undergone even a larger decrease, dropping from about 0.8 fatalities per MRVY in the 96-97 interval to about 0.2 in the current interval.

Figures 30 and 31 present model year analyses using the SCI data. The vehicle model year data were calculated by dividing the number of SCI fatalities for a given model year by the product of the cumulative number of vehicles registered (and equipped with a driver or passenger air bag) for these model year vehicles, times the number of years that these model year vehicles have been on the road. Hence, Figures 30 and 31 provide the equivalent of model year vehicle fatality rates, while Figures 28

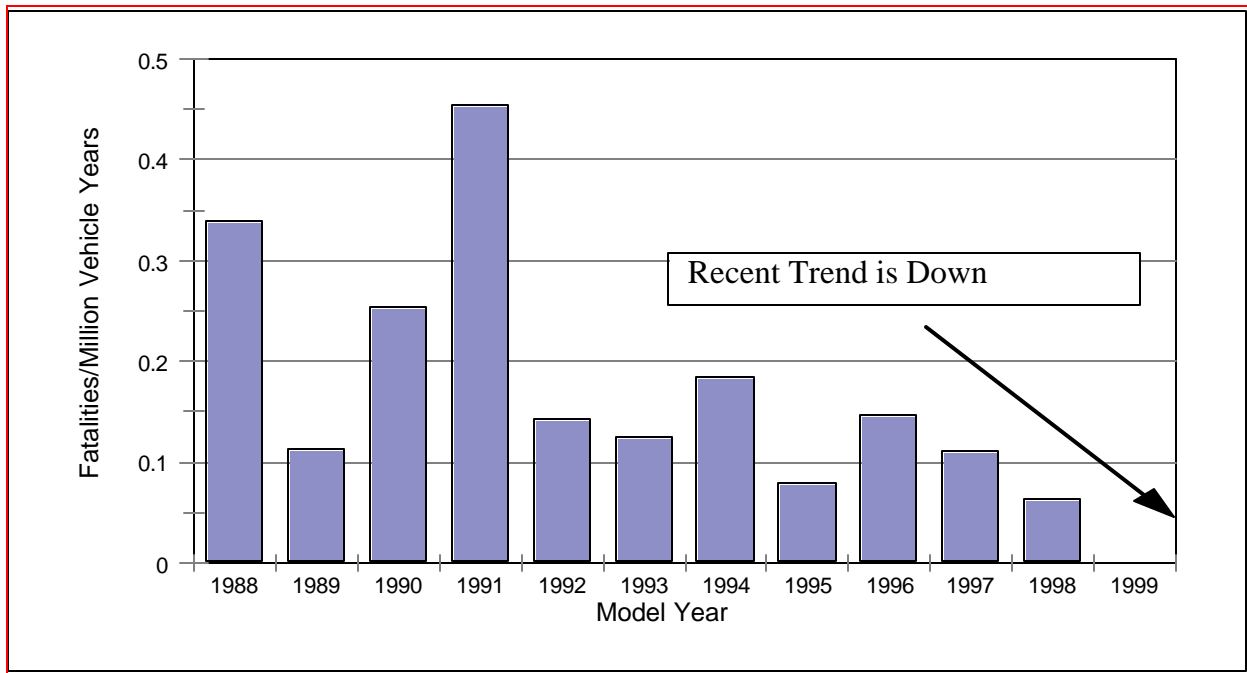

Figure 30. SCI Data for Fatal Drivers Normalized for Vehicle Registrations, by Model Year.

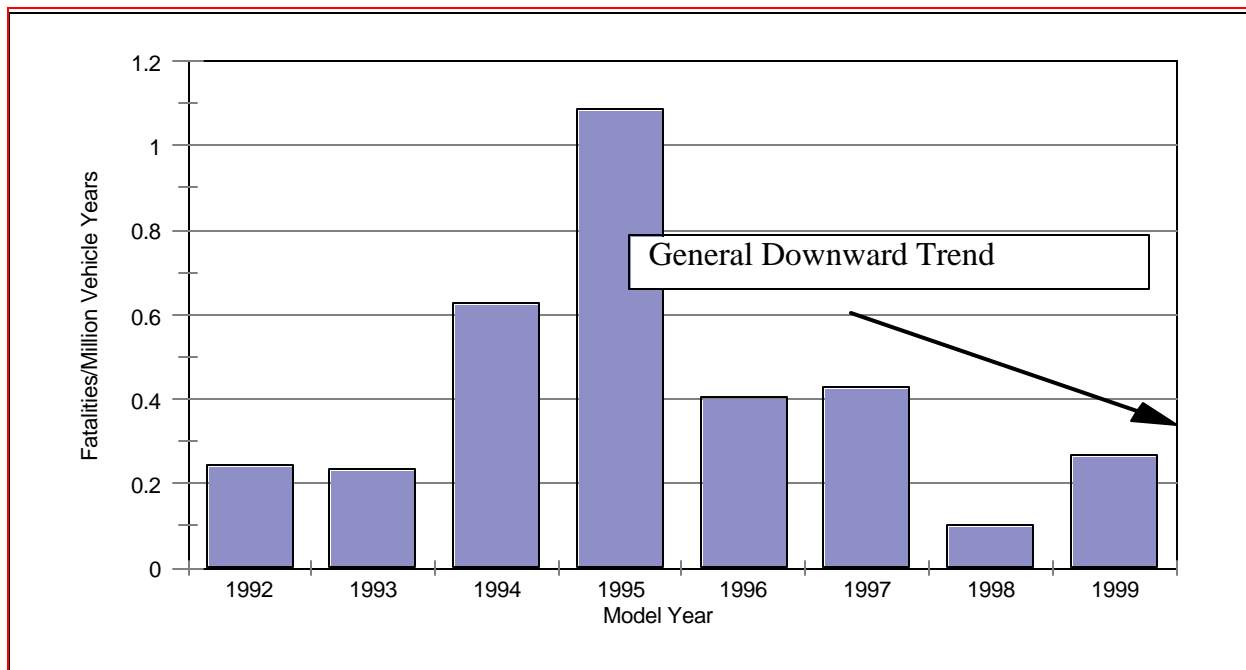

Figure 31. SCI Data for Fatal Passengers Normalized for Vehicle Registrations, by Model Year.

and 29 provide calendar year fatality rates. On the driver side, there has been a decrease in the fatality rate beginning with MY 1996, dropping from 0.15 fatalities per MRVY in MY 1996 to 0.05 fatalities per MRVY in MY 1998. As of September 1, 1999, there have been no driver air bag fatalities in MY 1999 vehicles. On the passenger side, the trend has been downward, in recent model years, from about 0.4 fatalities per MRVY in MYs 1996 and 1997 to about 0.25 in MY 1999 vehicles.

6.0 Findings

- On average, the inflator outputs of recently redesigned air bags have been significantly reduced. While there are variations among manufacturers and among vehicles of each manufacturer, analysis of the data provided by the manufacturers show a significant reduction in the average peak pressure and pressure rise rate of MY 1998 air bags in comparison to earlier air bags. However, those parameters increased in approximately ten percent of the vehicles covered by the information request and approximately one third showed no change.
- Changes in air bag volumes, vent sizes, inflator characteristics and other design changes have all contributed to a reduction in the safety risk from air bags, which is reflected in the dummy injury measures obtained from static deployment of air bags of various model years as well as in real world crash investigations.
- Based on static and dynamic tests using adult and child dummies and the injury measures obtained in those tests, it is clear that air bags in recent MY 1998 and 1999 vehicles are less aggressive than the pre-MY 1998 air bags. As such, these air bags generally pose less of an injury risk to out-of-position occupants. The special crash investigations of real-world cases tend to confirm this general trend showing a significant reduction in fatality rates due to air bags in recent MY vehicles.
- In high speed rigid barrier tests at 30 mph of seven MY 1998 and six MY 1999 vehicles, unbelted, 50th percentile male dummies were used in the driver and passenger seating positions. Three of the MY 1999 vehicles were also tested at 30 mph using 5th percentile unbelted dummies in the driver and passenger positions. The dummy injury measures for the 50th percentile male driver dummy showed that the HIC, chest 'g', chest deflection and the neck injury measures (Nij) were all within the threshold values. In a MY 1999 vehicle, the femur load exceeded the limit. For the passenger dummy, the chest 'g' value exceeded the limit by 1.4 'g' in one vehicle and all others met the requirements. In the tests conducted using the 5th percentile female dummy, the Nij exceeded the threshold value for the driver and the chest 'g', for the passenger in one vehicle. In another vehicle, the Nij exceeded the limit, for the passenger dummy.
- Manufacturers have made many changes to air bag designs. They are also on the threshold of making a significant leap in introduction of sophisticated technologies to improve air bag performance. For example, tailored inflation to suit different size occupants located in various positions in relation to the air bag and to match the severity of the crash will be a reality in the not too distant future. NHTSA's ongoing rulemaking to require advanced air bags will ensure that future air bags provide improved protection of belted as well as unbelted occupants of different sizes in moderate to high speed crashes, while minimizing risks posed by air bags to infants, children, and other occupants, especially in low speed crashes.

Appendix A. Model Year Trend Analysis

This appendix presents a number of graphical presentations of the data contained in the air bag information request database. Each page contains:

- C the title of the information presented;
- C the specific question number and verbal description of the question from the original information request sent to manufacturers (located at the bottom left of each page);
- C the particular graph;
- C a diagram (if appropriate) providing a definition and frame of reference for the information presented (located on the right of the page); and
- C a discussion of the information presented (also located on the right of the page).

The list of charts, presented on pages A-3 to A-4, describes all of the information presented in the appendix. The page number is located on the bottom left corner of each page.

The x-axis of each graph represents the **model year** of the vehicles. The data presented in the graphs represent the actual responses from manufacturers for each make/model/model year combination **WEIGHTED** by the number of vehicles of that particular make/model/model year that were registered in the U.S. according to R.L. Polk's National Vehicle Population Profile. This weighting is an important factor in developing these estimates since manufacturers provided information for each of their models and sub-models. For example, Mercedes-Benz, which sells relatively few vehicles each year, presented information on almost as many different models as General Motors, which has many different name plates built on a smaller number of similar platforms. The weighting gives the proper relative importance of each make/model in accordance with the numbers of vehicles on the road.

As an example of the information provided, the first graph shows the information for question A1A1 – Air Bag Location, Mounting and Deployment. The title of the graph is – *Driver Side Air Bag: Distribution of Module from Plane A, 1990-1998*. To the right of the graph is a *diagram of Plane A* and the definition – *Plane A is the plane tangent to the face of the steering wheel rim*. This is followed by a brief discussion of the data.

Each of the graphs present one of two types of information – categorical and numerical. For example, the first graph presents the air bag location information, which is categorical – either *Recessed*, *Flush* or *Protruded* relative to the steering wheel, as shown in the diagram to the right of the graph. The categorical information is presented as **stacked bar charts**, adding up to 100 percent.

The second graph presents numerical information – *Driver Side Air Bag: Distance from Plane A to the Portion of the Air Bag Module Closest to the Driver, 1990-1998*. The numerical information is presented as a **vertical line marking the 5th percentile, 95th percentile and average values**. Each vertical line extends between the 5th percentile (that is, 5 percent of the vehicles registered in that model

year have values less than or equal to the 5th percentile value) and the 95th percentile (that is, 95 percent of the vehicles registered in that model year have values less than or equal to the 95th percentile value, and conversely, 5 percent of the vehicles registered have values greater than or equal to the 95th percentile value) observed for the various vehicles for that model year in the database. The 5th and 95th percentiles were used in place of upper and lower standard deviations because many of the attributes do not follow a symmetrical (e.g., bell shaped) distribution, and the percentiles are less prone to distortions that can result from a few large outliers. The average value is marked on the vertical line by a solid box.

In a few cases, all of the data points provided were the same (e.g., *Number of Chambers in the Air Bag*) so no graph is provided. A simple description, such as: “*For all model years, there was only one chamber for both the driver and passenger air bags*” is provided.

Appendix A: List of Charts

Charts	Page
A1A1 Driver Side Air Bag: Distribution of Module from Plane A, 1990-1998	A-5
A1A2 Driver Side Air Bag: Distance from Plane A to the Portion of the Air Bag Module Closest to the Driver, 1990-1998	A-6
A1A3 Driver Side Air Bag Modules Designed to Move Away from the Occupant at the Time of Deployment, 1990-1998	A-7
A1A4 Passenger Side Air Bag Modules Designed to Move Away from the Occupant at the Time of Deployment, 1993-1998	A-8
A1B1 Passenger Side Air Bag: Distribution of Mounting Location, 1993-1998	A-9
B1-d Driver Side Air Bag: Area of the Opening, 1990-1998	A-10
B1-p Passenger Side Air Bag: Area of the Opening, 1993-1998	A-10
B1-d Driver Side Air Bag: Area of the Cover, 1990-1998	A-11
B1-p Passenger Side Air Bag: Area of the Cover, 1993-1998	A-11
B2-d Driver Side Air Bag: Minimum Breakout Pressure, 1990-1998	A-12
B2-p Passenger Side Air Bag: Minimum Breakout Pressure, 1993-1998	A-12
B3-d Driver Side Air Bag: Mass of Cover, 1990-1998	A-13
B3-p Passenger Side Air Bag: Mass of Cover, 1993-1998	A-13
B4 Driver Side Air Bag: Tear Patterns, 1990-1998	A-14
B4 Passenger Side Air Bag: Tear Patterns, 1993-1998	A-15
C1A Number of Chambers in the Air Bag	A-16
C1B Driver Side Air Bag: Fold Patterns, 1990-1998	A-17
C1B Passenger Side Air Bag: Fold Patterns, 1993-1998	A-18
C1C Material of Air Bag	A-19
C1C-d Driver Side Air Bag: Mass of Air Bag, 1990-1998	A-20
C1C-p Passenger Side Air Bag: Mass of Air Bag, 1993-1998	A-20
C1D-d Driver Side Air Bag: Inflation Time, 1990-1998	A-21
C1D-p Passenger Side Air Bag: Inflation Time, 1993-1998	A-21
C1E-d Driver Side Air Bag: Volume of Fully Inflated Air Bag, 1990-1998	A-22
C1E-p Passenger Side Air Bag: Volume of Fully Inflated Air Bag, 1993-1998	A-22
C1F-d Driver Side Air Bag: Number of Tethers, 1990-1998	A-23
C1F-p Passenger Side Air Bag: Number of Tethers, 1993-1998	A-23
C1G1 Driver Side Air Bag: Distance between Plane J and Plane K, 1990-1998	A-24
C1G2 Driver Side Air Bag: Distance between Plane F and Plane K, 1990-1998	A-25
C1G3 Driver Side Air Bag: Maximum Distance the Air Bag Reaches Laterally on Each Side of Plane N, 1990-1998	A-26
C1G4 Passenger Side Air Bag: Distance from Plane C to Plane E for Top-Mounted Air Bags, 1993-1998	A-27

Appendix A: List of Charts

Charts		Page
C1G5	Passenger Side Air Bag: Distance between Plane B and Plane I for Air Bags Other than Top-Mounted, 1993-1998	A-28
C1G6	Passenger Side Air Bag: Distance between Planes H and I for Air Bags Other than Top-Mounted, 1993-1998	A-29
C1H1	Passenger Side Air Bag: Distance between Plane C and Plane L for Top-Mounted Air Bags, 1993-1998	A-30
C1H2	Passenger Side Air Bag: Distance between Plane D and Plane L for Air Bags Other Than Top-Mounted, 1993-1998	A-31
C1H3	Passenger Side Air Bag: Distance between Planes G and L for Air Bags Other than Top-Mounted, 1993-1998	A-32
C1H4	Passenger Side Air Bag: Maximum Distance the Air Bag Reaches Laterally on Each Side of Plane M, 1993-1998	A-33
C2A-IT-d	Driver Side Air Bag: Inflator Type, 1990-1998	A-34
C2A-IT-p	Passenger Side Air Bag: Inflator Type, 1993-1998	A-34
C2A-IA-d	Driver Side Air Bag: Inflating Agent, 1990-1998	A-35
C2A-IA-p	Passenger Side Air Bag: Inflating Agent, 1993-1998	A-35
C2B-d	Driver Side Air Bag: Number of Inflation Stages, 1990-1998	A-36
C2B-p	Passenger Side Air Bag: Number of Inflation Stages, 1993-1998	A-36
C2C4-d	Driver Side Air Bag: Scaled Rise Rate, 1990-1998	A-37
C2C4-p	Passenger Side Air Bag: Scaled Rise Rate, 1993-1998	A-37
C2C4-d	Driver Side Air Bag: Scaled Peak Pressure, 1990-1998	A-38
C2C4-p	Passenger Side Air Bag: Scaled Peak Pressure, 1993-1998	A-38
D1-d	Driver Side Air Bag: Stiffness of the Seat Belts (force/elongation), 1990-1998	A-39
D1-p	Passenger Side Air Bag: Stiffness of the Seat Belts (force/elongation), 1993-1998	A-39
D2-d	Driver Side Air Bag: Presence of Load Limiters in the Seat Belt, 1990-1998	A-40
D2-p	Passenger Side Air Bag: Presence of Load Limiters in the Seat Belt, 1993-1998	A-40
D3-d	Driver Side Air Bag: Presence of Pretensioners in the Seat Belt, 1990-1998	A-41
D3-p	Passenger Side Air Bag: Presence of Pretensioners in the Seat Belt, 1993-1998	A-41
D4-d	Driver Side Air Bag: Presence of Web Clamps in the Seat Belt, 1990-1998	A-42
D4-p	Passenger Side Air Bag: Presence of Web Clamps in the Seat Belt, 1993-1998	A-42
E1	Number of Sensors, 1990-1998	A-43
E1	Location of Sensors, 1990-1998	A-44
E1	Type of Sensors, 1990-1998	A-45

Driver Side Air Bag: Distribution of Module from Plane A, 1990-1998

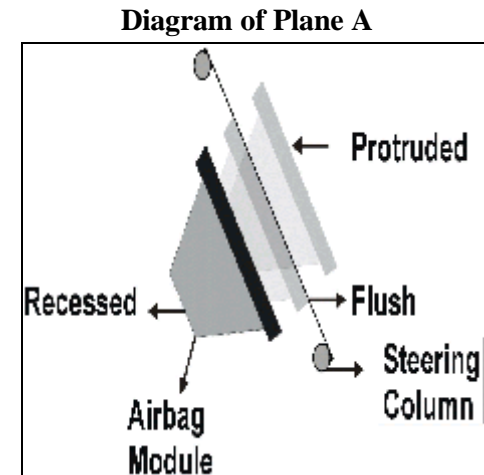
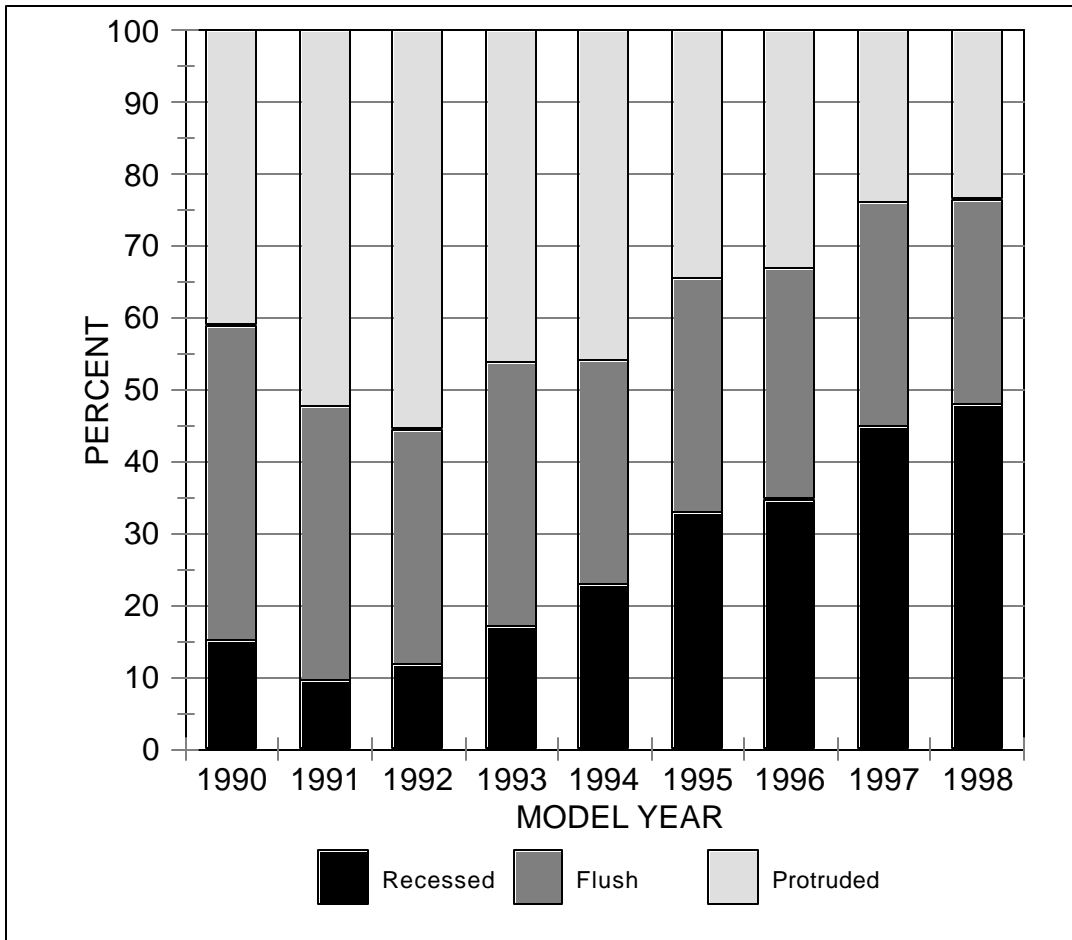

Definition: Plane A is the plane tangent to the face of the steering wheel rim.

Discussion: The chart depicts the variation of the placement of the air bag module from Plane A. For the past seven years, the percentage of flush air bag modules has remained constant while the percentage of recessed modules has increased and the percentage of protruded modules has decreased.

Driver Side Air Bag: Distance from Plane A to the Portion of the Air Bag Module Closest to the Driver, 1990-1998

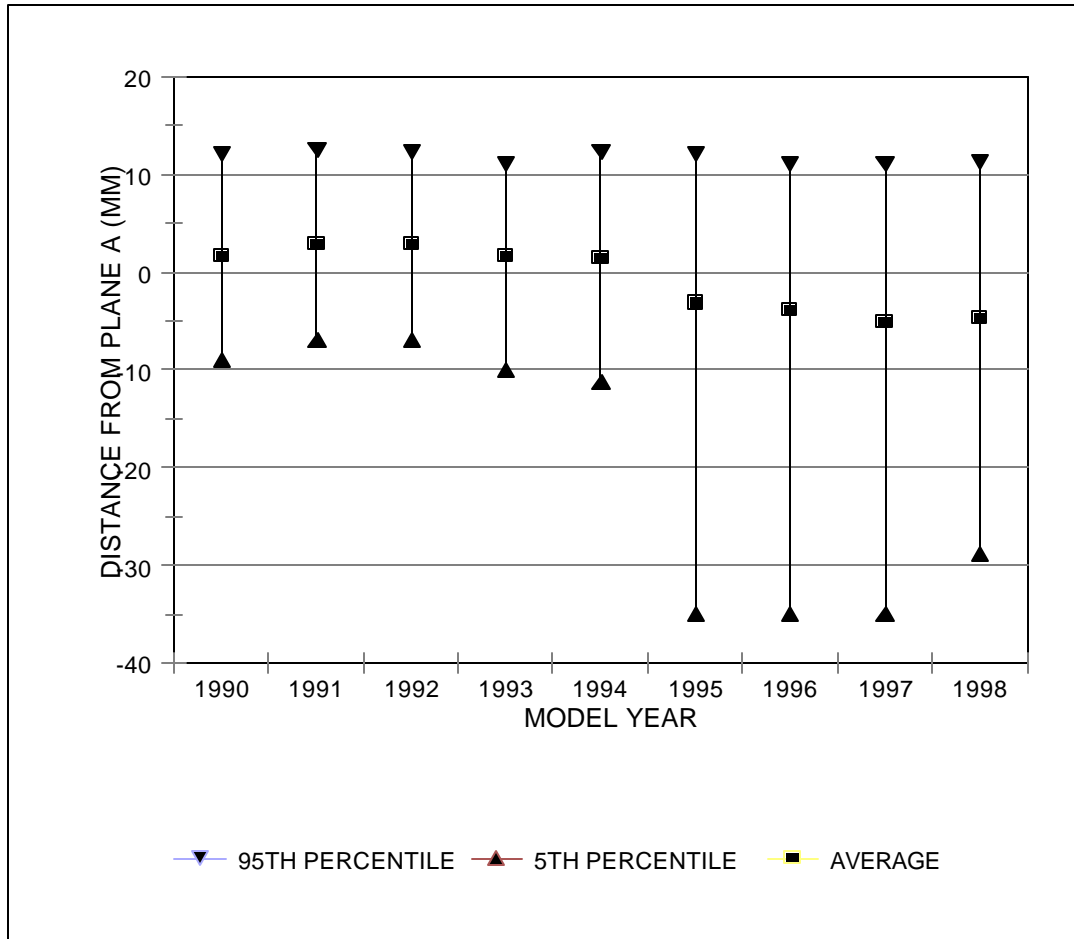
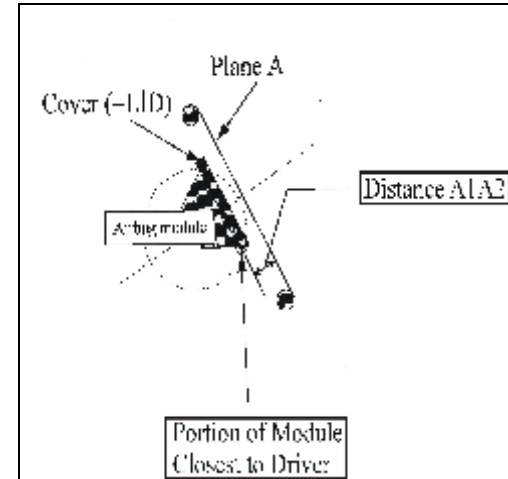
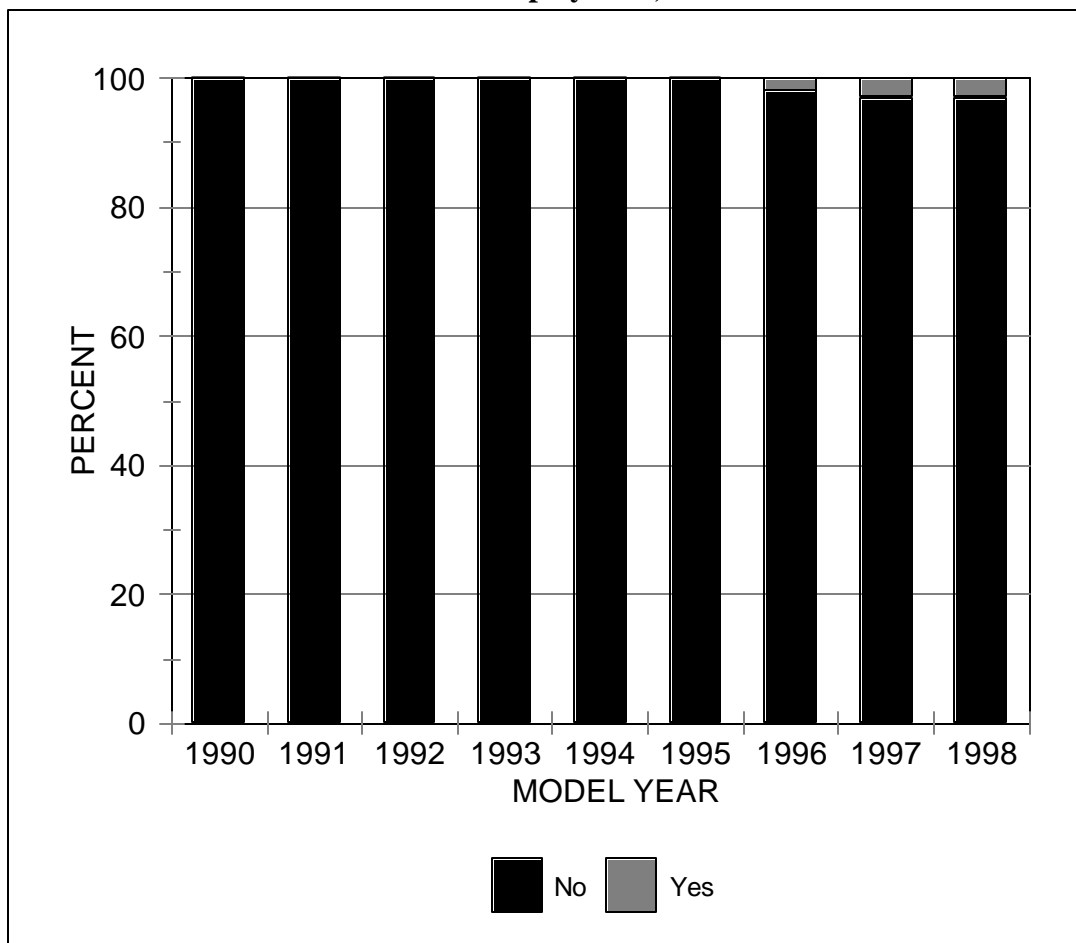

Diagram of Plane A



Discussion: Negative values depict air bags recessed with respect to the steering wheel while positive values represent protruding air bags. The chart shows a trend towards recessed driver air bags or air bags being placed further away from the driver. The average distance decreased from +2.8 mm in 1991 to approximately -4.7 mm in 1998.

Driver Side Air Bag Modules Designed to Move Away from the Occupant at the Time of Deployment, 1990-1998



Discussion: The majority of driver side air bag modules were not designed to move away from the driver at the time of deployment. In 1996, air bag modules that were designed to move away from the driver at the time of deployment surfaced.

Passenger Side Air Bag Modules Designed to Move Away from the Occupant at the Time of Deployment, 1993-1998

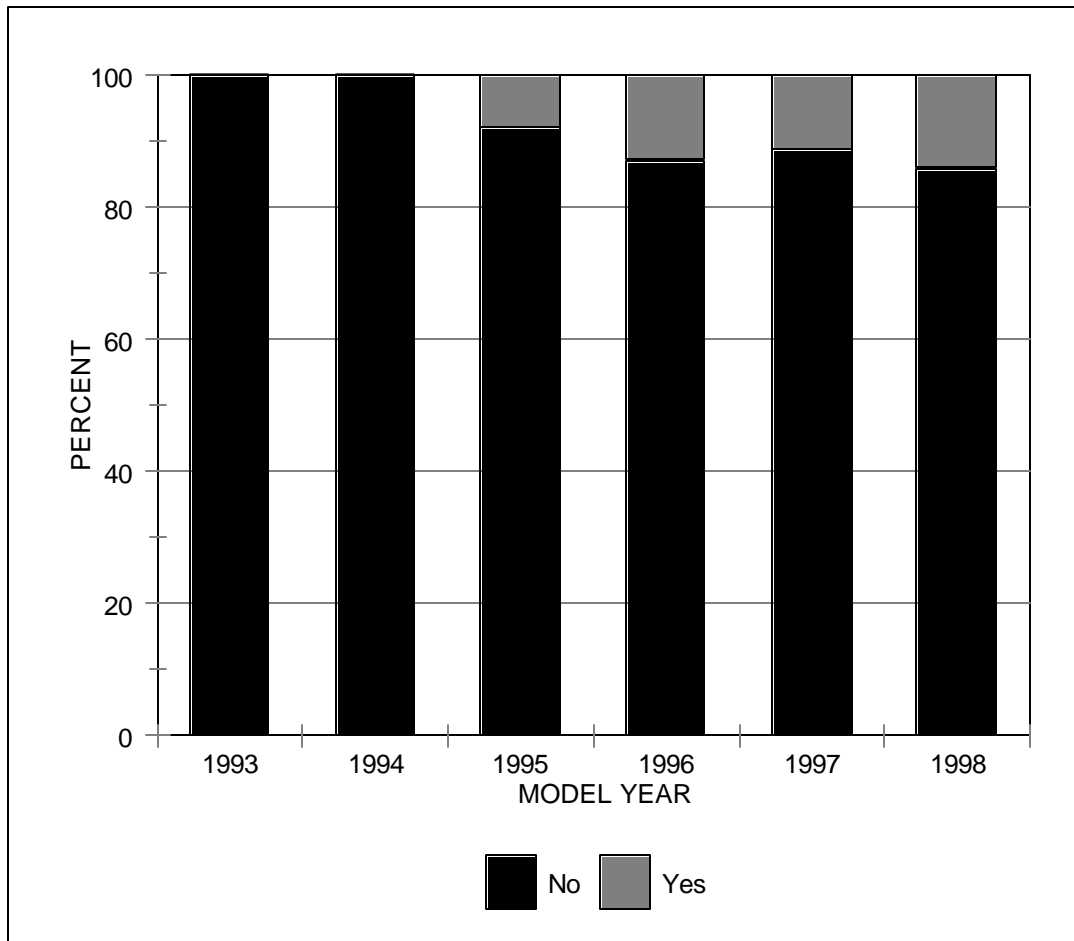

Discussion: The majority of passenger side air bag modules were not designed to move away from the passenger at the time of deployment. In 1995, air bag modules that were designed to move away from the occupant at the time of deployment surfaced. From 1995 to 1998, the number of air bags modules that were designed to move away from the occupant almost doubled.

Passenger Side Air Bag: Distribution of Mounting Location, 1993-1998

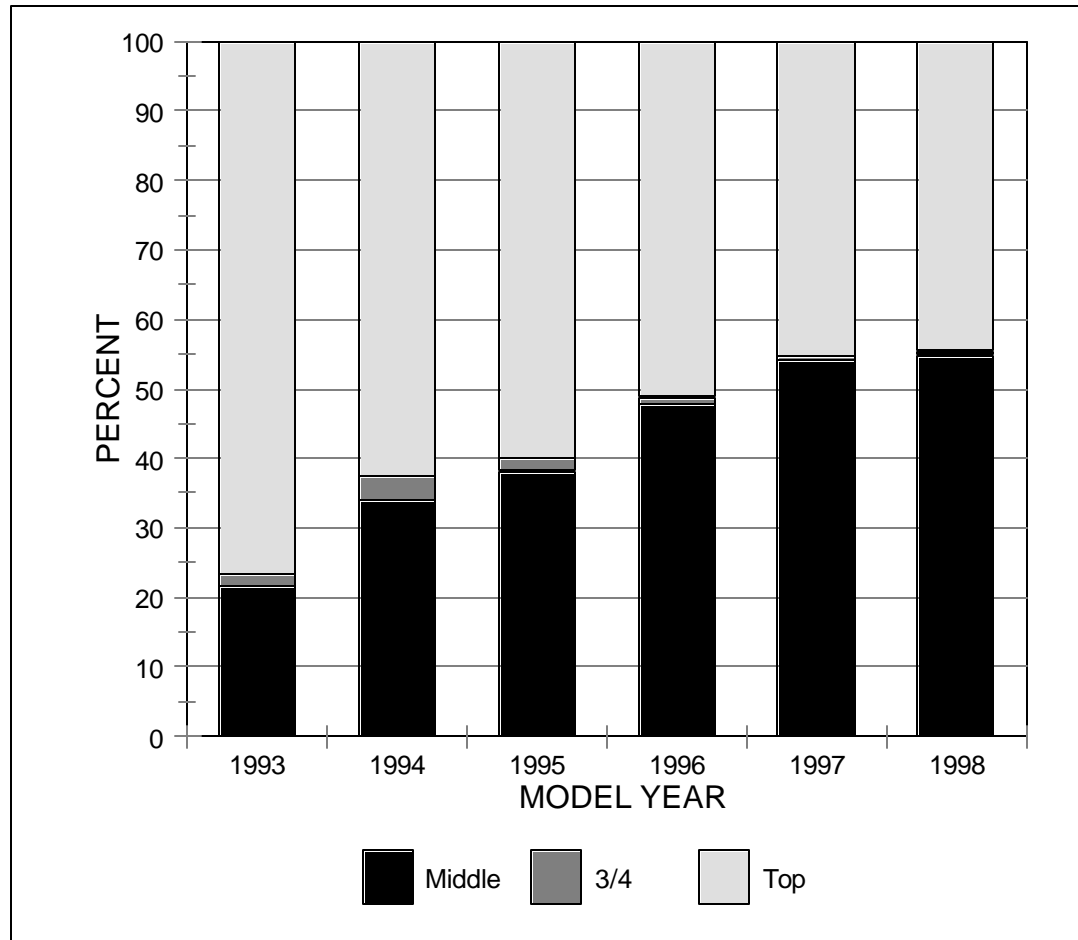

Mounting of Passenger Air Bag on the Instrument Panel

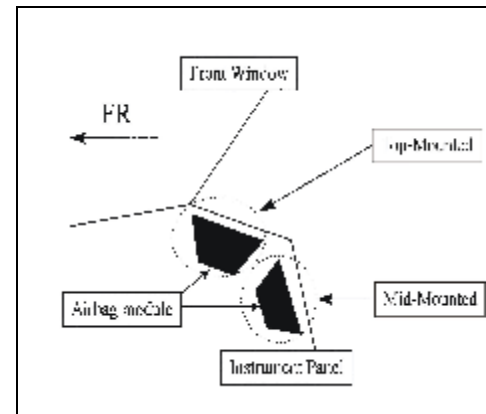

Discussion: The figure depicts the variation of the placement of the passenger air bag on the instrument panel. From 1993 to 1998, the percentage of mid-mounted air bags increased while the percentage of top-mounted air bags decreased.

Driver Side Air Bag: Area of the Opening, 1990-1998

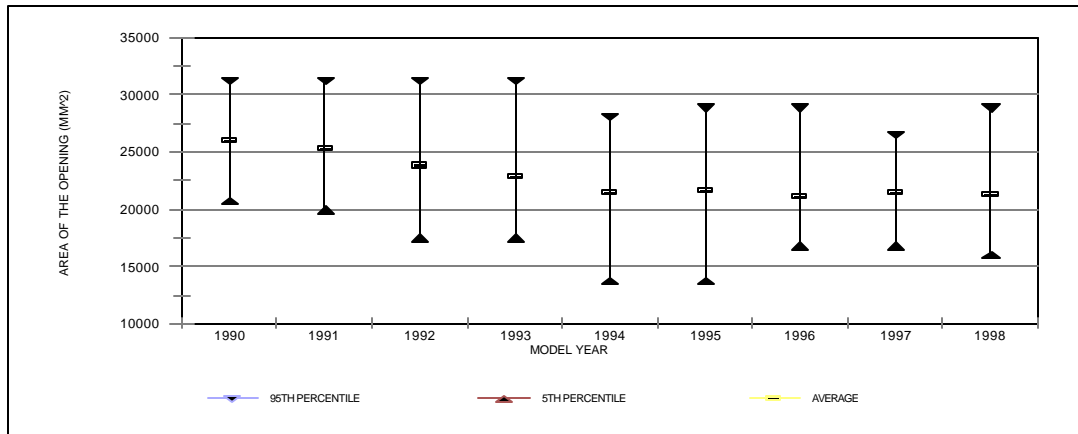

Passenger Side Air Bag: Area of the Opening, 1993-1998

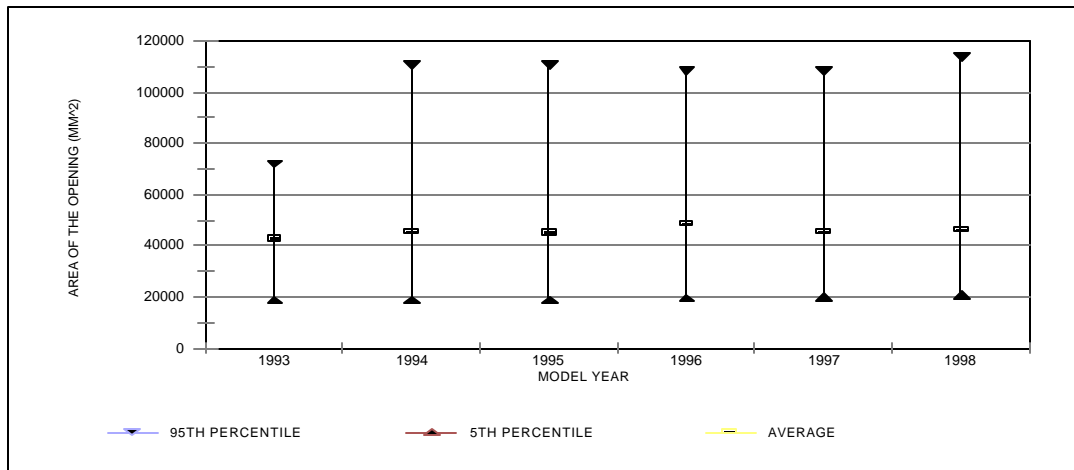

Discussion

The charts illustrate the distribution of the area of the opening through which the air bag is deployed.

Driver Side: The chart shows a downward trend towards smaller air bag openings. The average area of the opening decreased from a high of approximately 26,000 mm² in 1990 to 21,000 mm² in 1998.

Passenger Side: As depicted in the chart, there has been a consistent trend in the average area of the opening of approximately 46,000 mm².

Driver Side Air Bag: Area of the Cover, 1990-1998

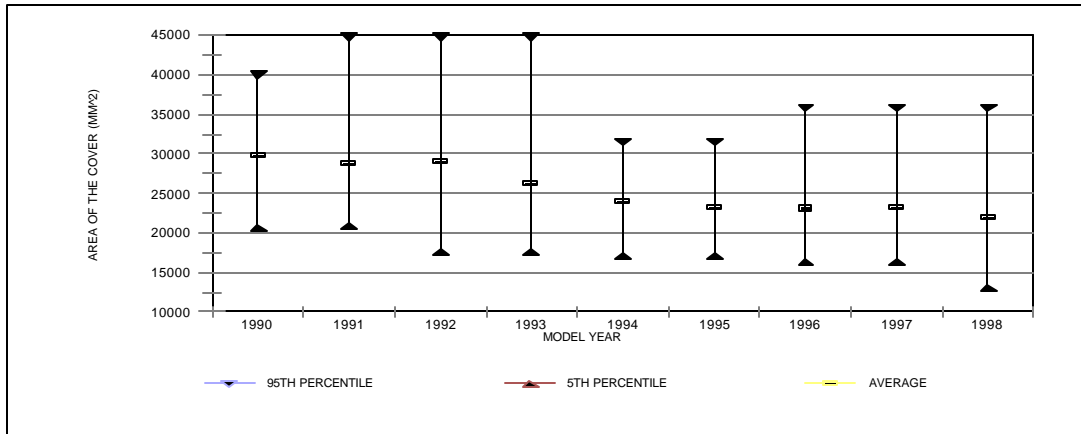

Passenger Side Air Bag: Area of the Cover, 1993-1998

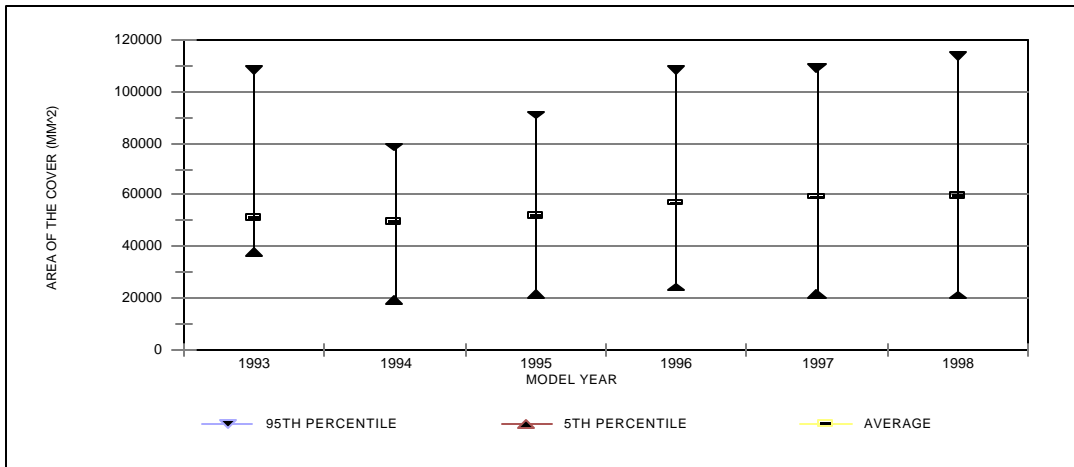

Discussion

The charts illustrate the distribution of the area of the opening through which the air bag is deployed.

Driver Side: The chart shows a downward trend towards smaller air bag openings. The average area of the opening decreased from a high of approximately 26,000 mm² in 1990 to 21,000 mm² in 1998.

Passenger Side: As depicted in the chart, there has been a consistent trend in the average area of the opening of approximately 46,000 mm².

Driver Side Air Bag: Minimum Breakout Pressure, 1990-1998

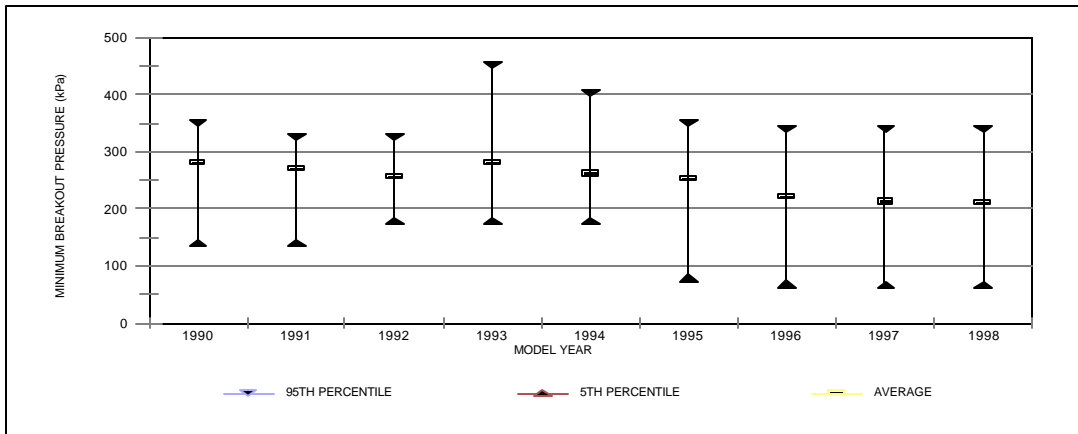

Passenger Side Air Bag: Minimum Breakout Pressure, 1993-1998

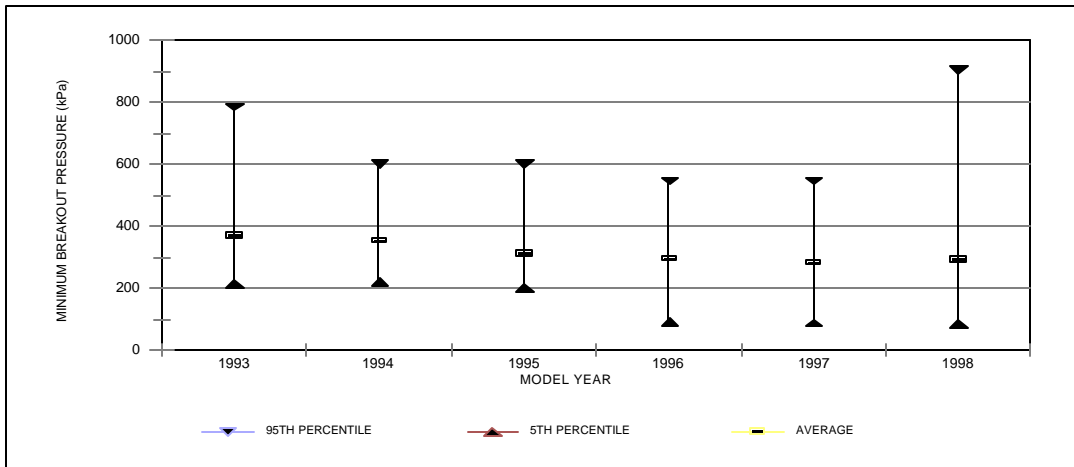

Definition: The minimum breakout pressure is the pressure required for the air bag to breakthrough the air bag module cover at the time of deployment. The wide range of pressures are due to the use of different air bag cover material or the thickness of the tear line.

Discussion: The minimum breakout pressure was not reported for approximately 50 percent of the driver and passenger side air bags.

Driver Side: The average minimum breakout pressure decreased slightly from 1990 to 1992. Although there was a slight increase in the average breakout pressure in 1993, the average pressure has been steadily decreasing since 1994.

Passenger Side: The average minimum breakout pressure decreased 21 percent from 1993 (367 kpa) to 1998 (291 kpa).

Driver Side Air Bag: Mass of Cover, 1990-1998

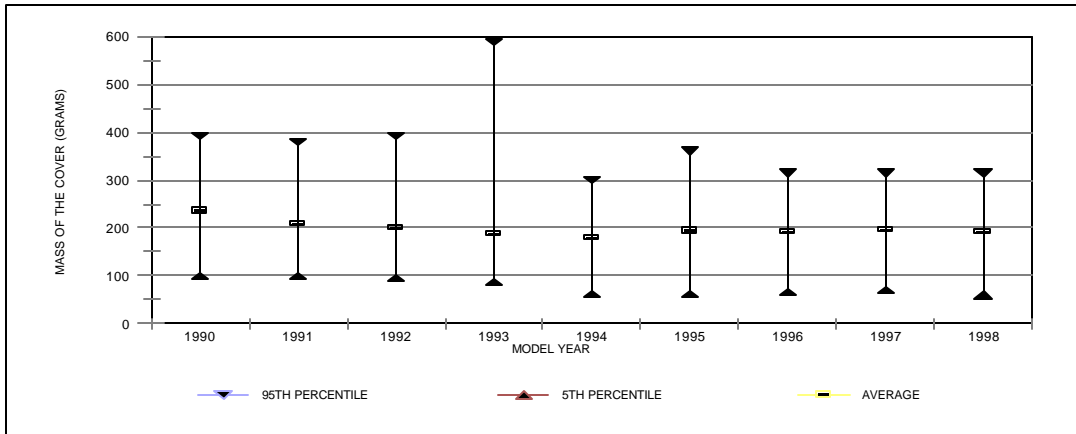

Driver Side: From 1990 to 1994, there was a downward trend towards a slightly lighter air bag cover. Beginning in 1995, the average mass of the cover began to increase slightly. The average mass of the cover has remained basically the same from 1995 to 1998.

Passenger Side Air Bag: Mass of Cover, 1993-1998

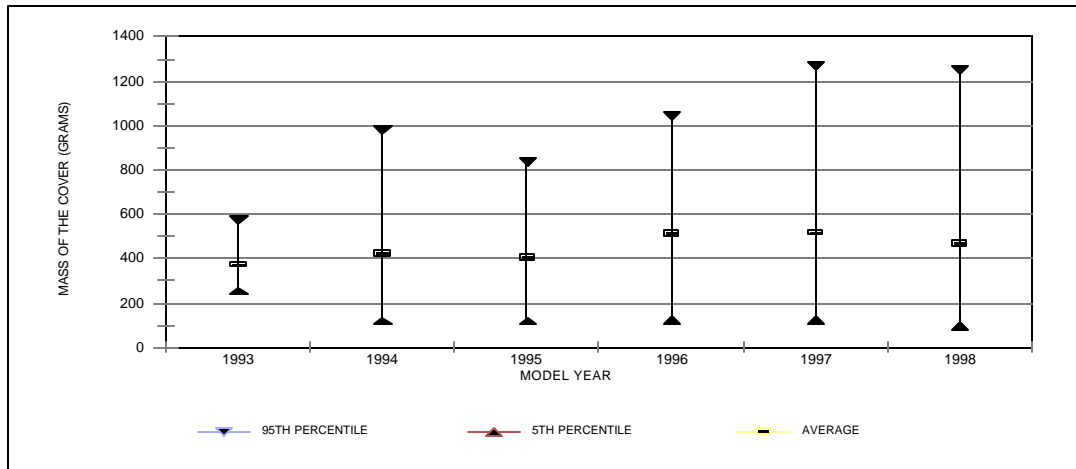

Passenger Side: The average mass of the passenger air bag cover has fluctuated over time. In a limited number of models, the entire top of the instrument panel is allowed to open to permit the deployment of the passenger air bag. The spread between the average values and the 95th percentile values are due to a few designs in which the entire top of the instrument panel is opened to permit air bag deployment.

Driver Side Air Bag: Tear Patterns, 1990-1998

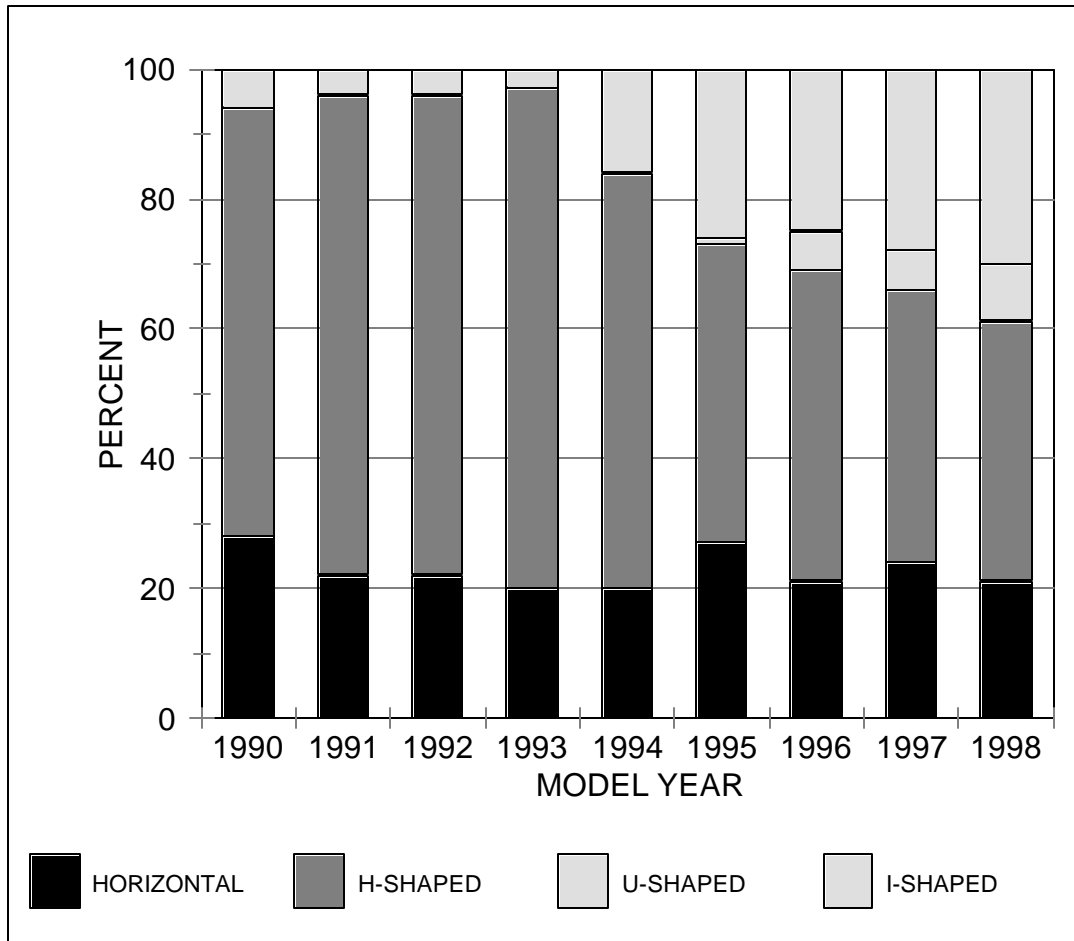

Illustrations of Driver Side Air Bag Tear Patterns

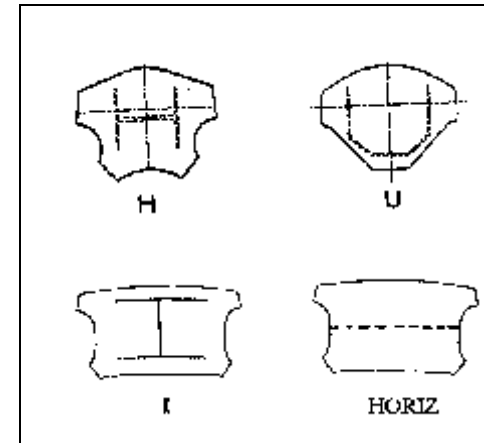

Discussion: The chart depicts four predominant tear patterns in driver air bag covers. In 1994, the H-shaped tear pattern began decreasing in air bags while the I-shaped tear pattern began increasing. In 1995, the U-shaped tear pattern was present in approximately one percent of all tear patterns. The horizontal tear pattern has comprised between 20 and 28 percent of all types of tear patterns since 1990.

Passenger Side Air Bag: Tear Patterns, 1993-1998

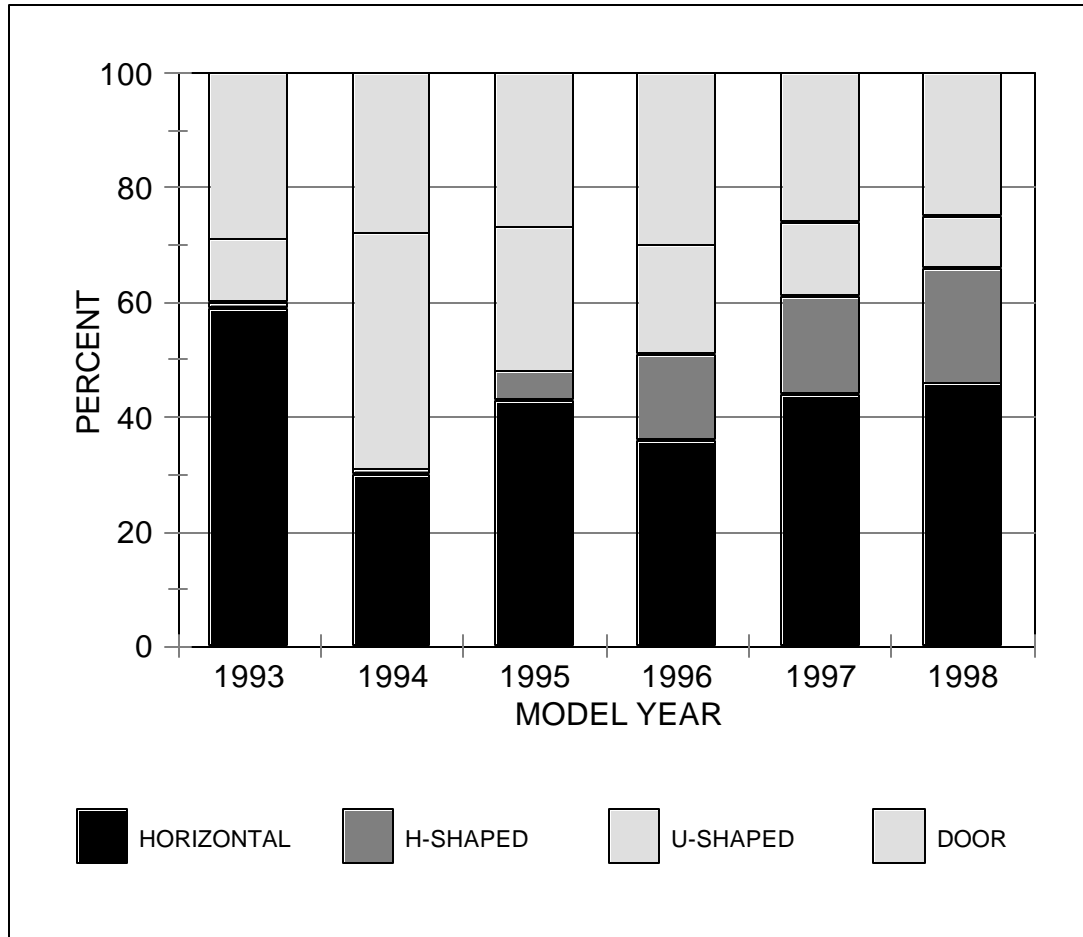

Illustrations of Passenger Side Air Bag Tear Patterns

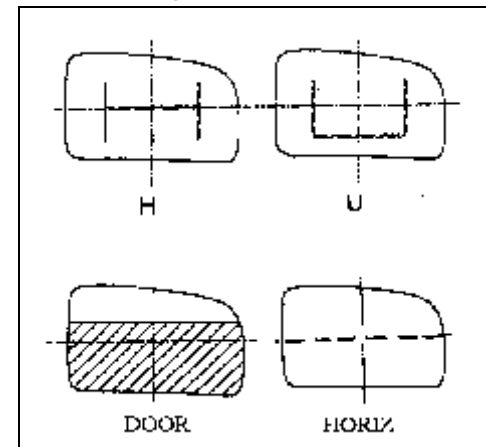

Discussion: The chart depicts four predominant tear patterns in passenger air bag covers. In 1995, the H-shaped tear pattern began increasing in air bags while the U-shaped tear pattern began decreasing. The horizontal and door tear patterns have fluctuated over the past several years.

Number of Chambers in the Air Bag

For all model years, there was only one chamber in both the driver side and the passenger side air bags.

Driver Side Air Bag: Fold Patterns, 1990-1998

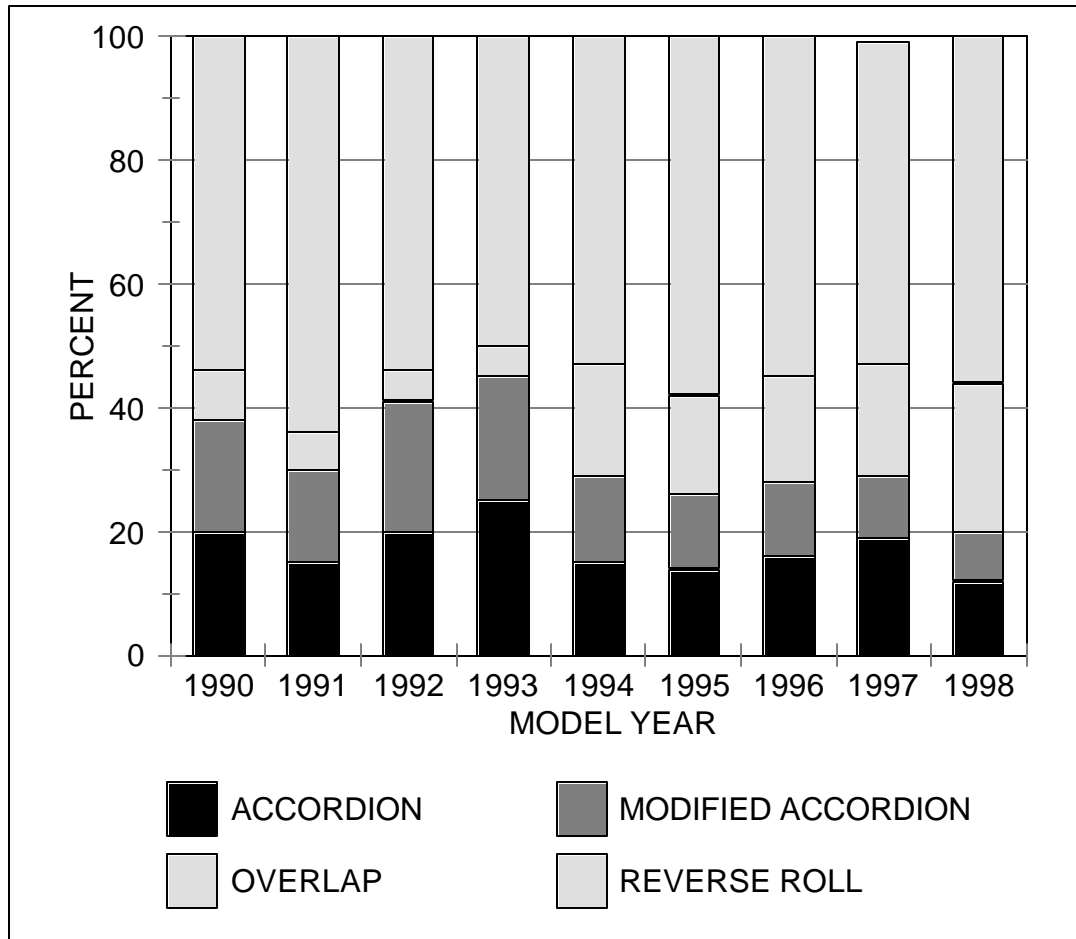

Illustrations of Driver Side Air Bag Fold Patterns

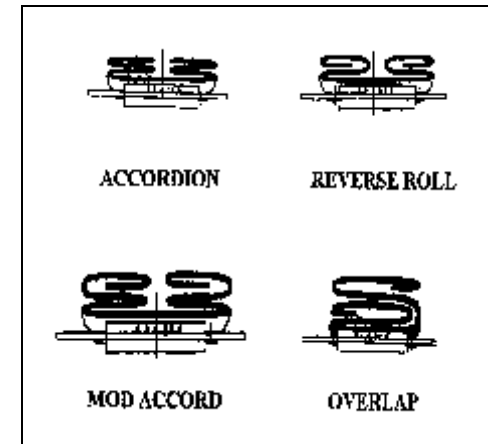

Discussion: The chart depicts four predominant fold patterns used for driver air bags. The reverse roll has been the predominant fold in driver air bags since 1990. In 1994, the percentage of overlap folds began to increase while the percentage of modified accordion folds began to decrease. The presence of accordion folds in air bags has fluctuated since 1990.

Passenger Side Air Bag: Fold Patterns, 1993-1998

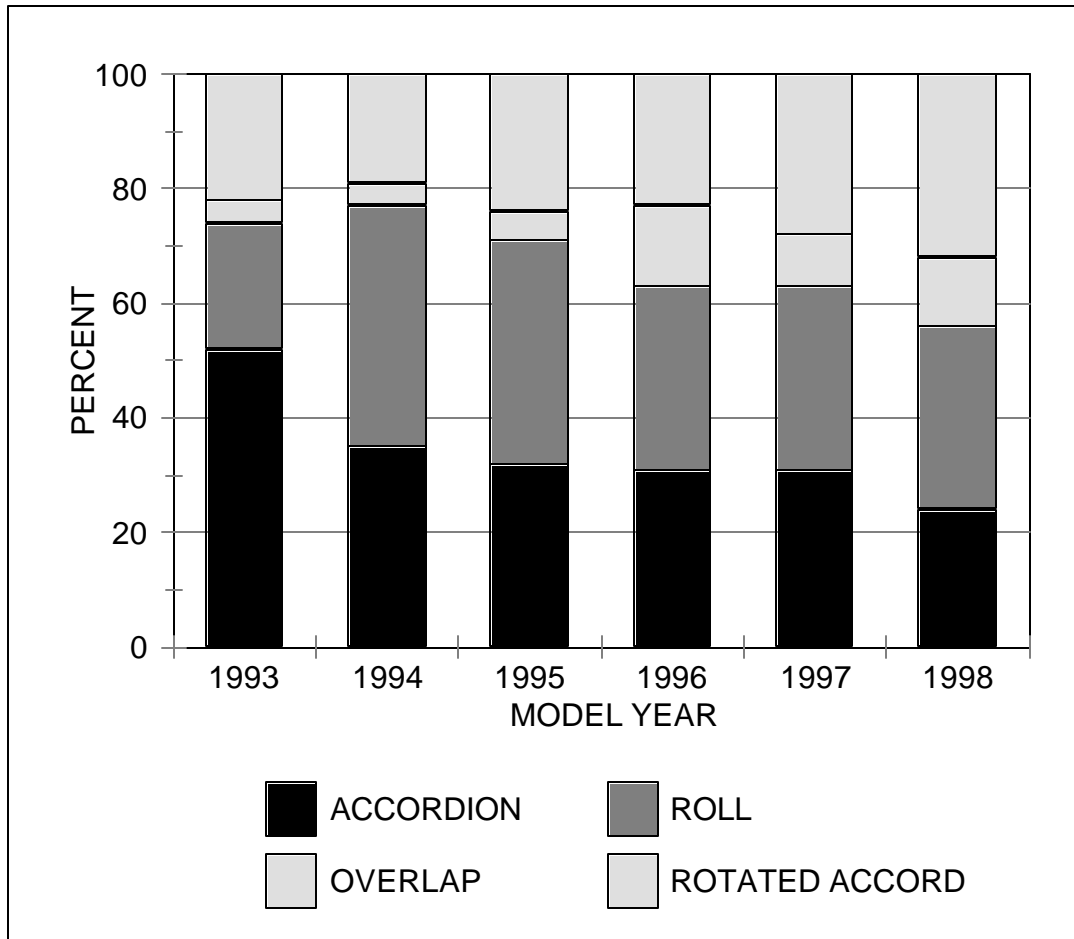

Illustrations of Passenger Side Air Bag Fold Patterns

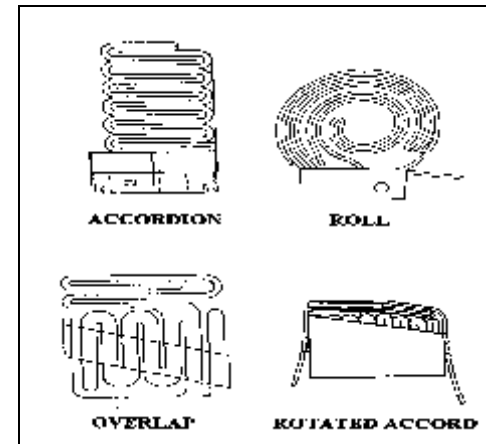

Discussion: The chart depicts four predominant fold patterns used for passenger air bags. From 1993 to 1994, accordion folds decreased approximately 17 percent while the percentage of roll folds almost doubled. Since 1993, the percentage of overlap folds in passenger air bags has fluctuated. Rotated accordion folds have been increasing since 1997.

Material of the Air Bag

For all model years, the manufacturers reported approximately 60 different air bag material types. Thirty-one percent of the driver air bags were Nylon and thirty-one percent of the passenger air bags were Nylon. Most of the other material types contained some variation of Nylon or other type of material.

Driver Side Air Bag: Mass of Air Bag, 1990-1998

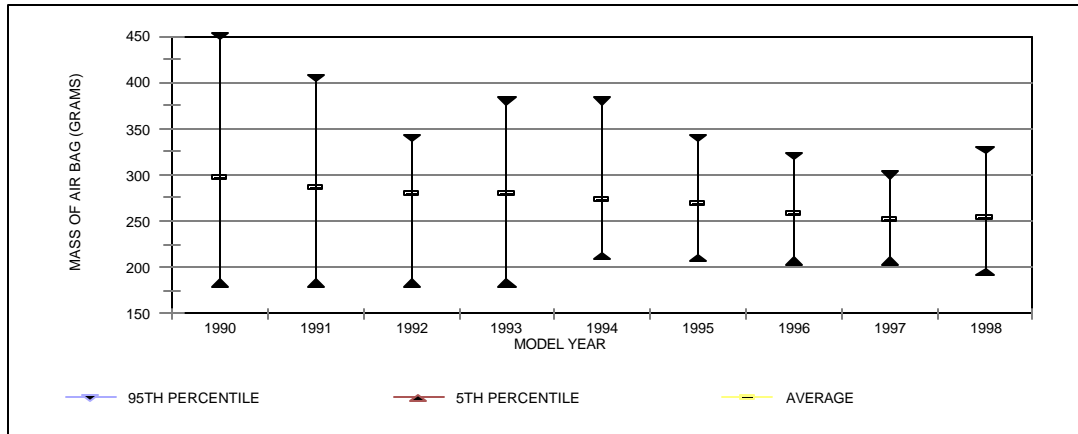

Driver Side: The chart shows a small trend towards a lighter air bag. The average mass of the air bag decreased approximately 15 percent from 1990 (297 grams) to 1998 (253 grams).

Passenger Side: The average mass of the passenger air bag decreased approximately 9 percent from 1993 (630 grams) to 1998 (572 grams).

Passenger Side Air Bag: Mass of Air Bag, 1993-1998

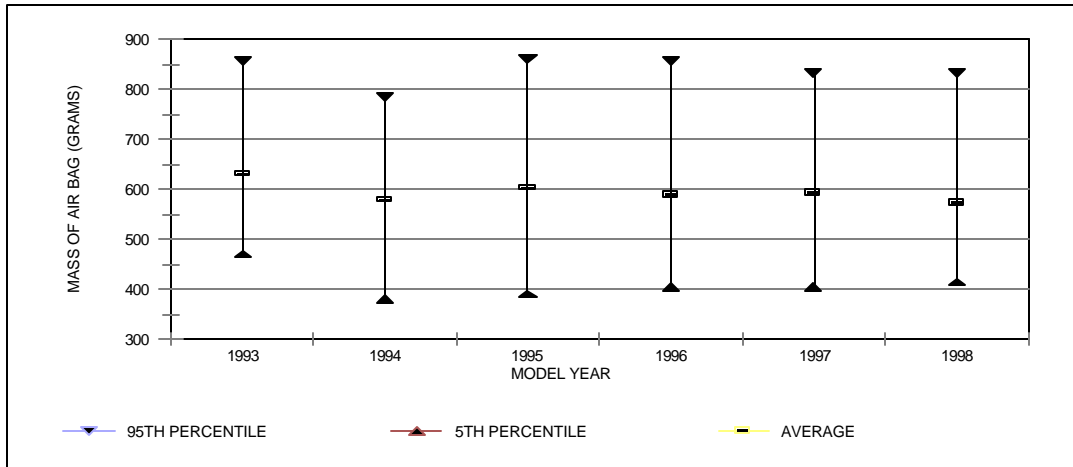

Driver Side Air Bag: Inflation Time, 1990-1998

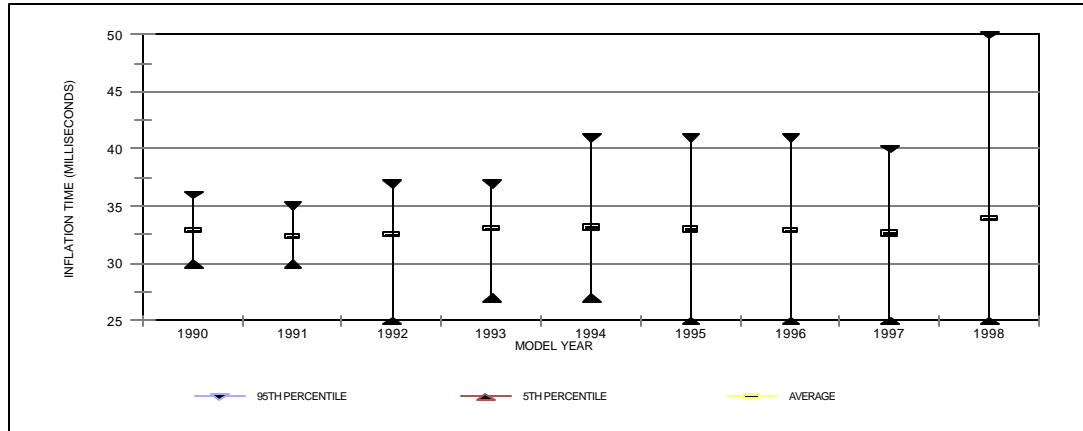

Definition: The inflation time is the time from the initiation of inflation to full inflation.

Driver Side: The chart represents a consistent average inflation time of approximately 33 milliseconds for all driver air bag modules.

Passenger Side: From 1993 to 1994, the average inflation time decreased approximately 14 percent and continued to decrease until 1996. The average inflation time increased slightly from 1996 to 1997.

Passenger Side Air Bag: Inflation Time, 1993-1998

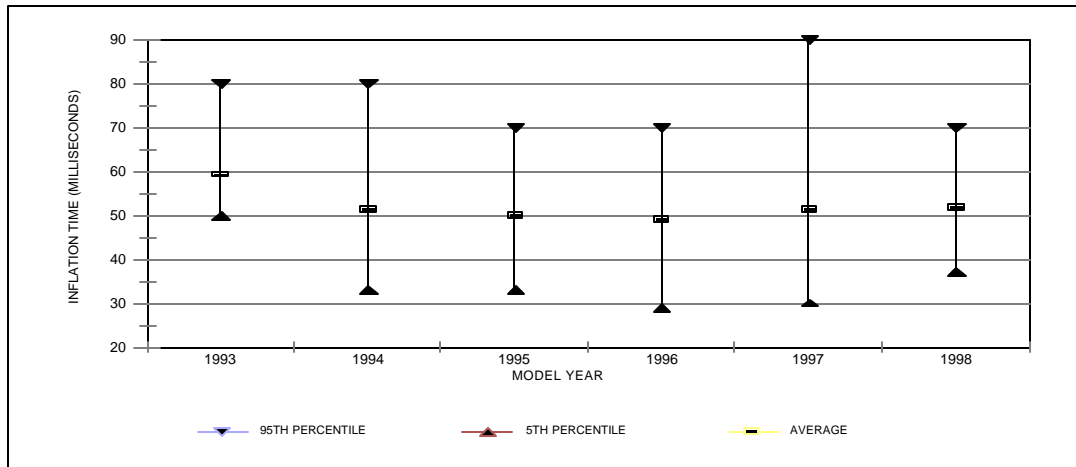

Driver Side Air Bag: Volume of Fully Inflated Air Bag, 1990-1998

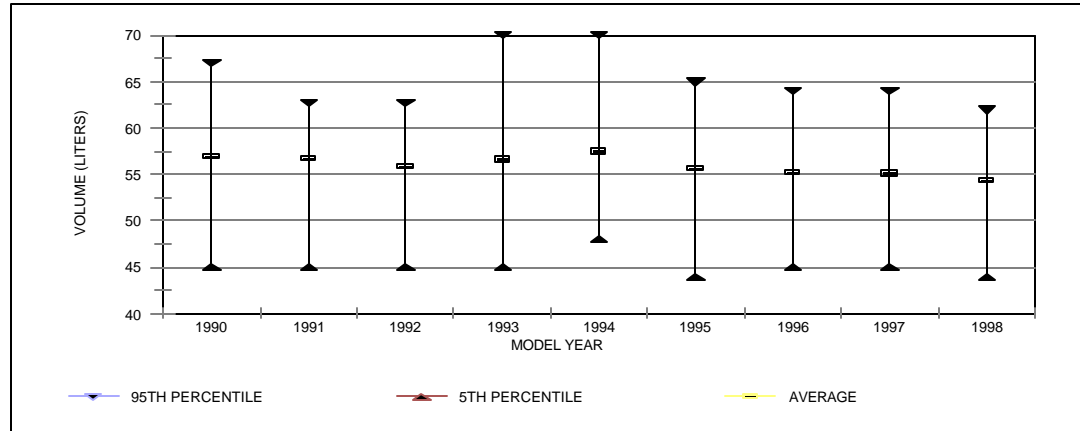

Driver Side: The chart shows a relatively stable average volume of the fully inflated driver air bag between approximately 54 and 57 liters.

Passenger Side Air Bag: Volume of Fully Inflated Air Bag, 1993-1998

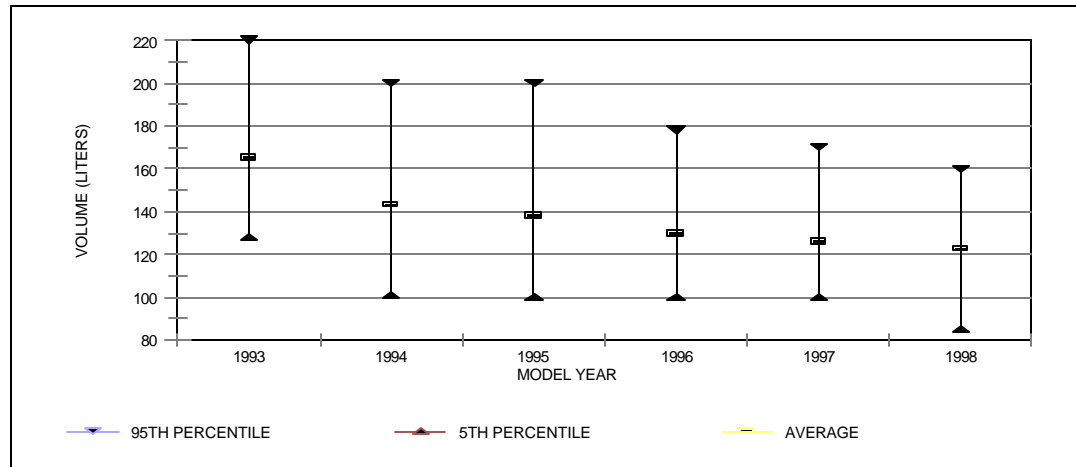

Passenger Side: As depicted in the chart, there is a downward trend in the volume of the fully inflated passenger air bags. From 1993 to 1998, there was a 26 percent decrease in the average volume of the fully inflated air bag.

Driver Side Air Bag: Number of Tethers, 1990-1998

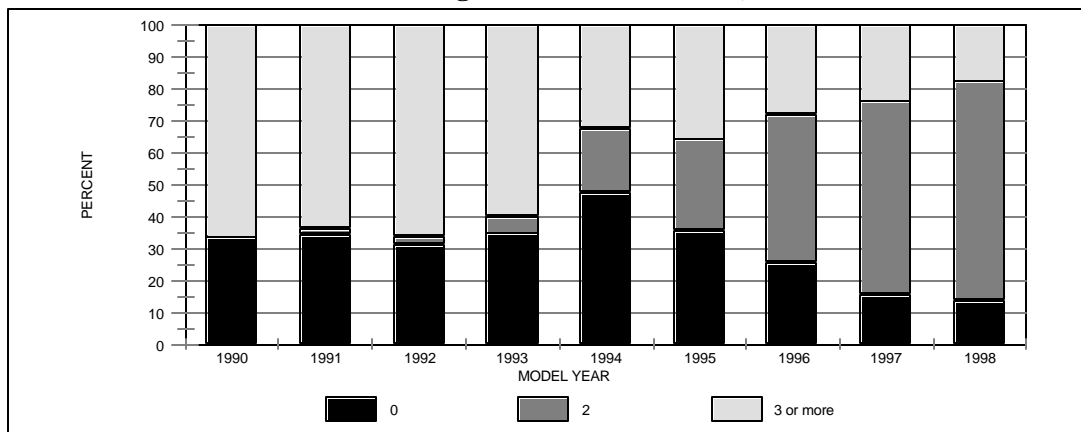

Driver Side: The chart shows an increasing trend towards two-tethered driver air bags. From 1990 to 1993, a majority of the driver air bags were tethered by 3 or more tethers or were untethered. From 1994 to 1998, the percentage of two-tethered air bags tripled while the percentage of untethered air bags or air bags tethered by 3 or more tethers decreased. There were no one-tethered driver air bags.

Passenger Side Air Bag: Number of Tethers, 1993-1998

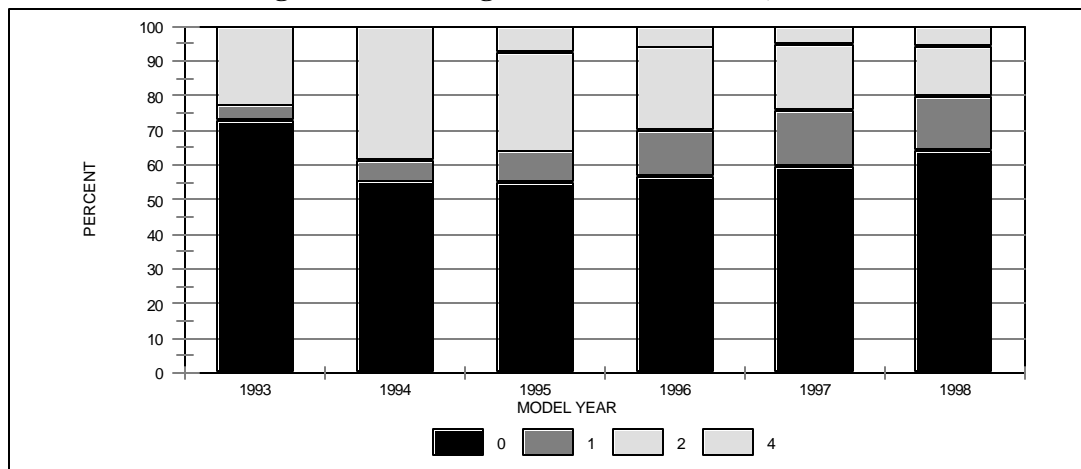

Passenger Side: Untethered passenger air bags continue to comprise a large percentage of all air bags. Although the percentage of two-tethered air bags increased from 1993 to 1994, two-tethered air bags have been decreasing since 1995. There were no three-tethered passenger air bags.

Driver Side Air Bag: Distance between Plane J and Plane K, 1990-1998

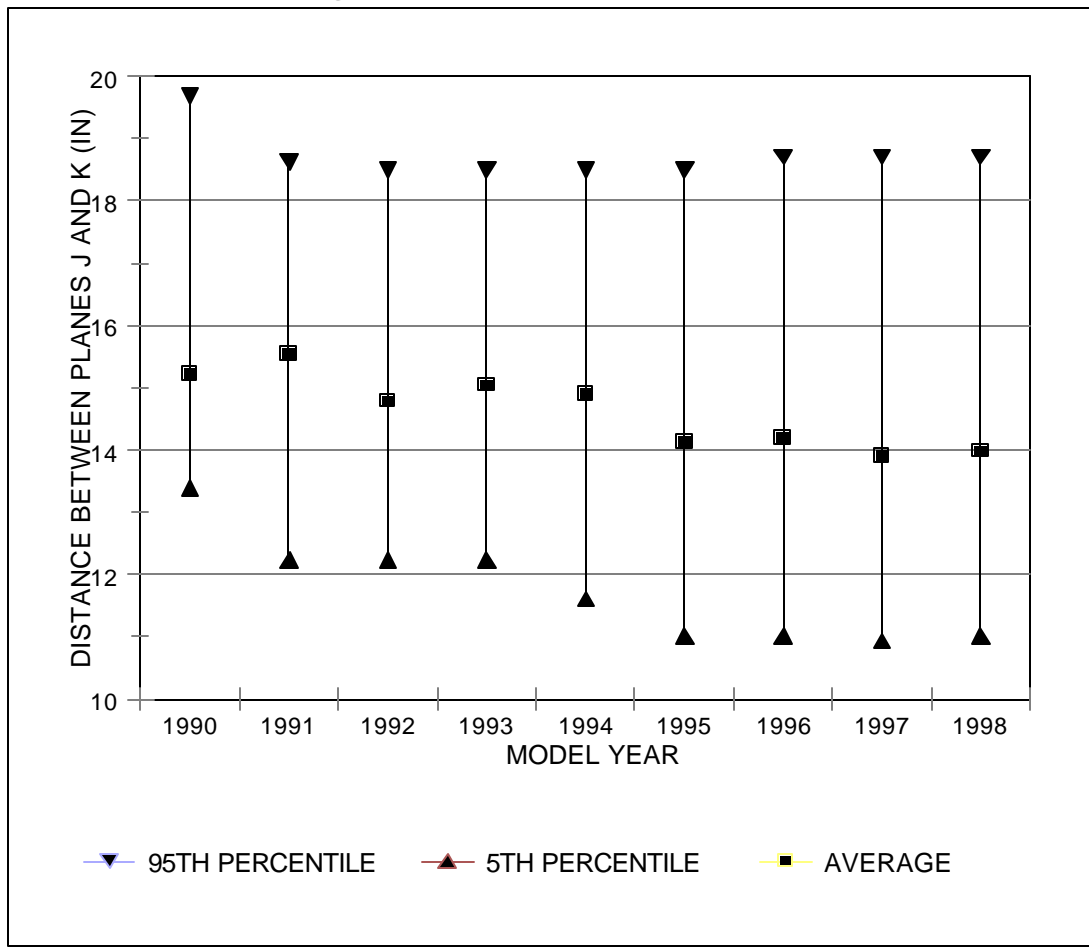
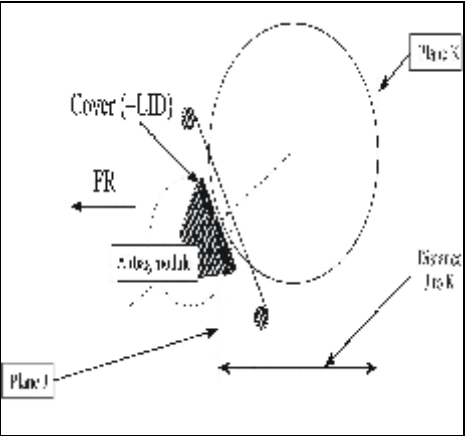

Diagram of Planes



Definition: Plane J is the transverse vertical plane that passes through the center point on the surface of the driver air bag cover. Plane K is the transverse vertical plane that passes through the maximum rearward point that the driver air bag reaches at any time during deployment.

Discussion: The average distance between Planes J and K has fluctuated slightly for many years, however, the average distance has been relatively stable since 1995.

Driver Side Air Bag: Distance between Plane F and Plane K, 1990-1998

NOTE : Negative values denote deployment behind the seating reference point.

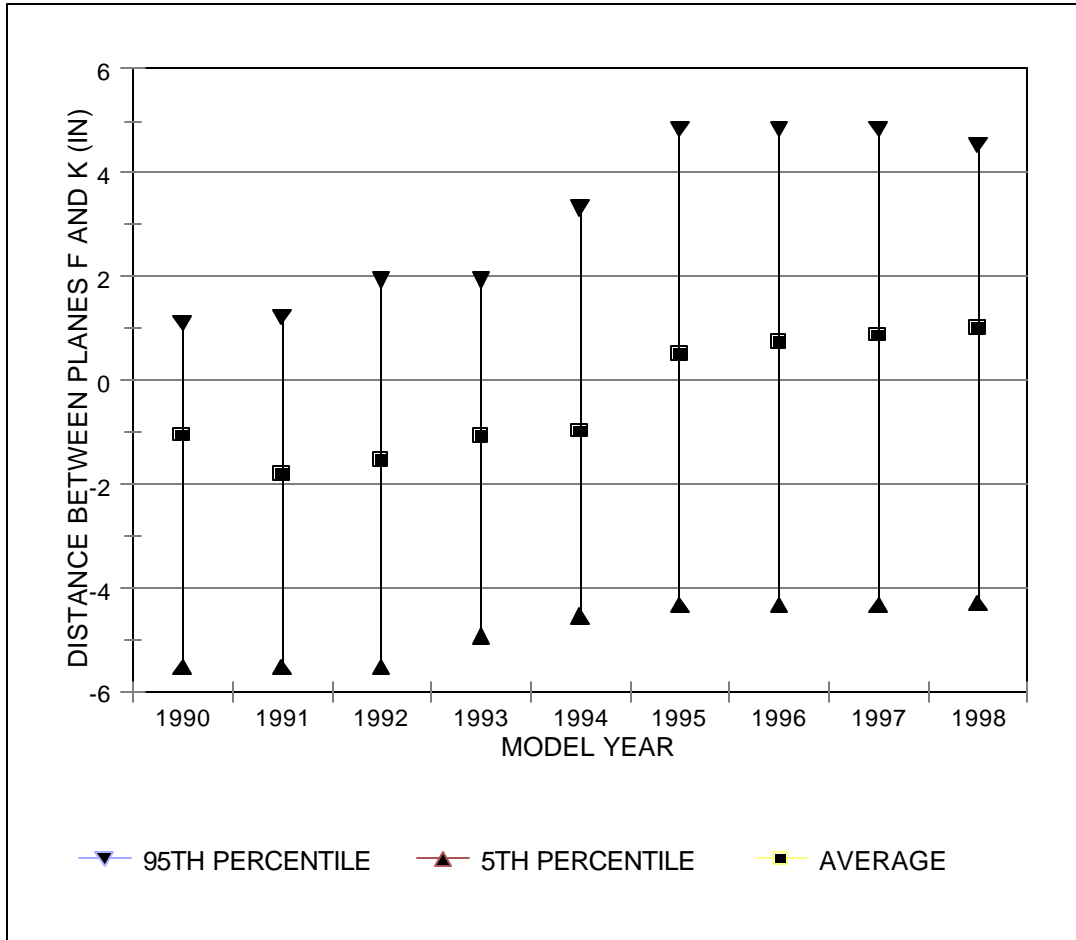
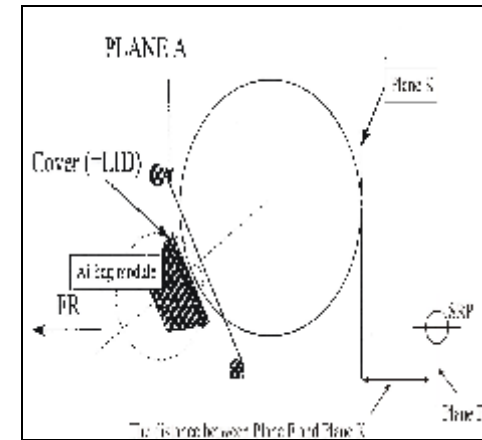

Diagram of Planes



Definition: Plane F is the transverse vertical plane that passes through the seating reference point (SRP) for the driver position. Plane K is the transverse vertical plane that passes through the maximum rearward point that the driver air bag reaches at any time during deployment.

Discussion: The average distance between Planes F and K has changed from approximately -2.0 inches in the early years to approximately +1.0 inch in later years. This change indicates that the maximum rearward point is moving forward relative to the SRP.

Driver Side Air Bag: Maximum Distance the Air Bag Reaches Laterally on Each Side of Plane N, 1990-1998

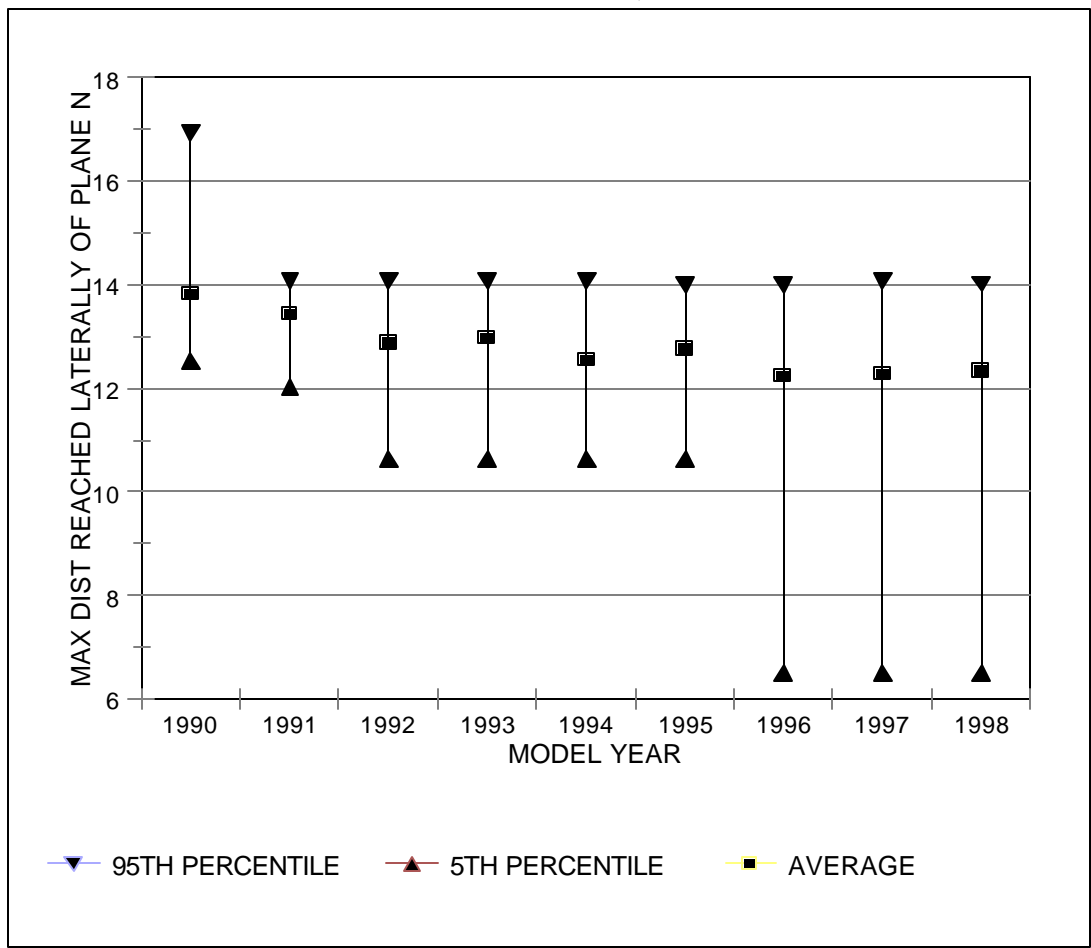

Definition: Plane N is the longitudinal vertical plane that passes through the centerline of the Hybrid III dummy as positioned at the front outboard driver seating position.

Discussion: The chart depicts the trend of the average lateral half-width the driver air bag reaches. The half-width has decreased from a high of 13.8 inches in 1990 to 12.3 inches in 1998, an 11 percent decrease.

Passenger Side Air Bag: Distance from Plane C to Plane E for Top-Mounted Air Bags

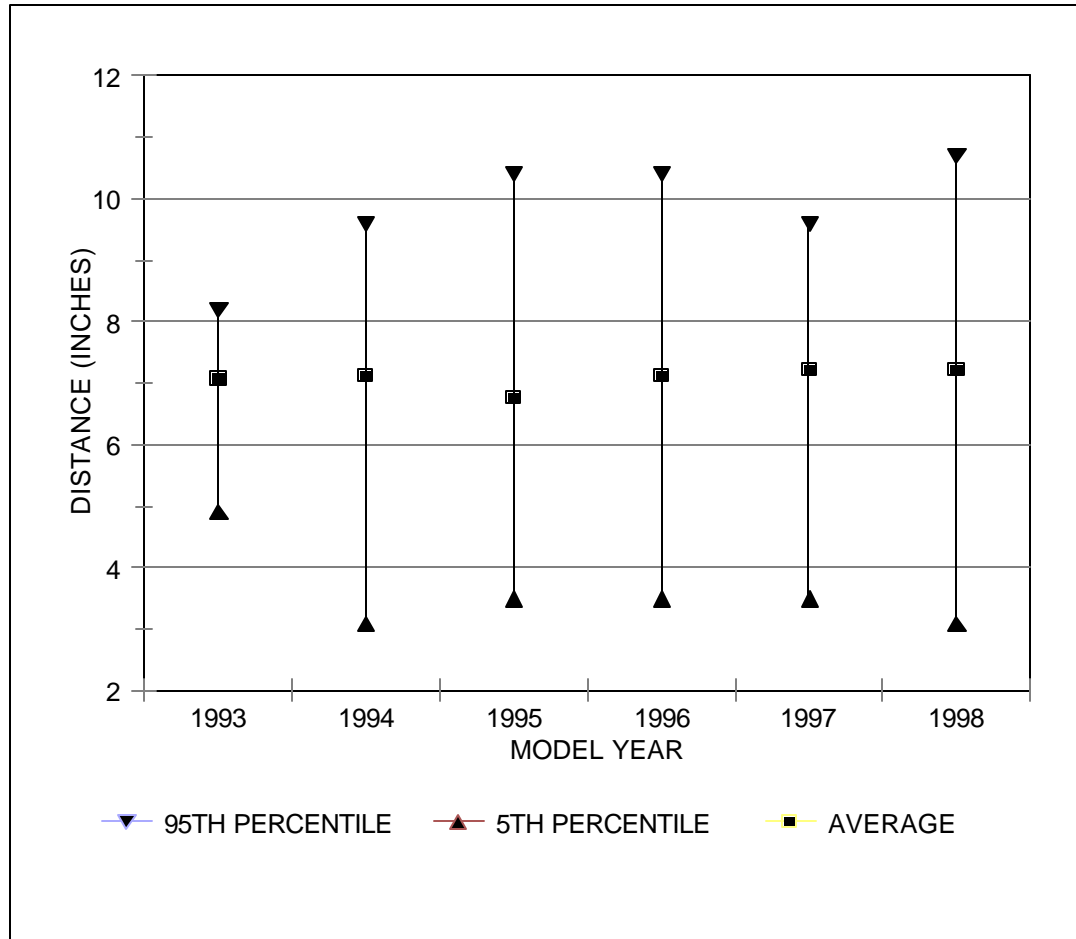
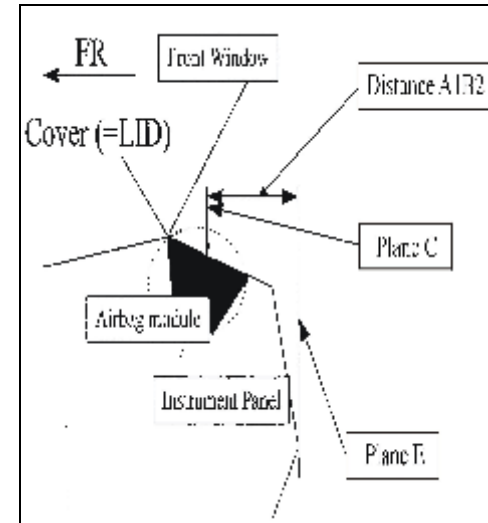

Diagram of Plane C to Plane E for Top-Mounted Air Bags



Definition: Plane C is the transverse vertical plane that passes through the center point of the passenger air bag cover. Plane E is the transverse vertical plane tangent to the rearmost portion of the passenger portion of the instrument panel.

Discussion: The average distance from Plane C to Plane E has remained relatively stable from 1993 to 1998.

Passenger Side Air Bag: Distance between Plane B and Plane I for Air Bags Other than Top-Mounted, 1993-1998

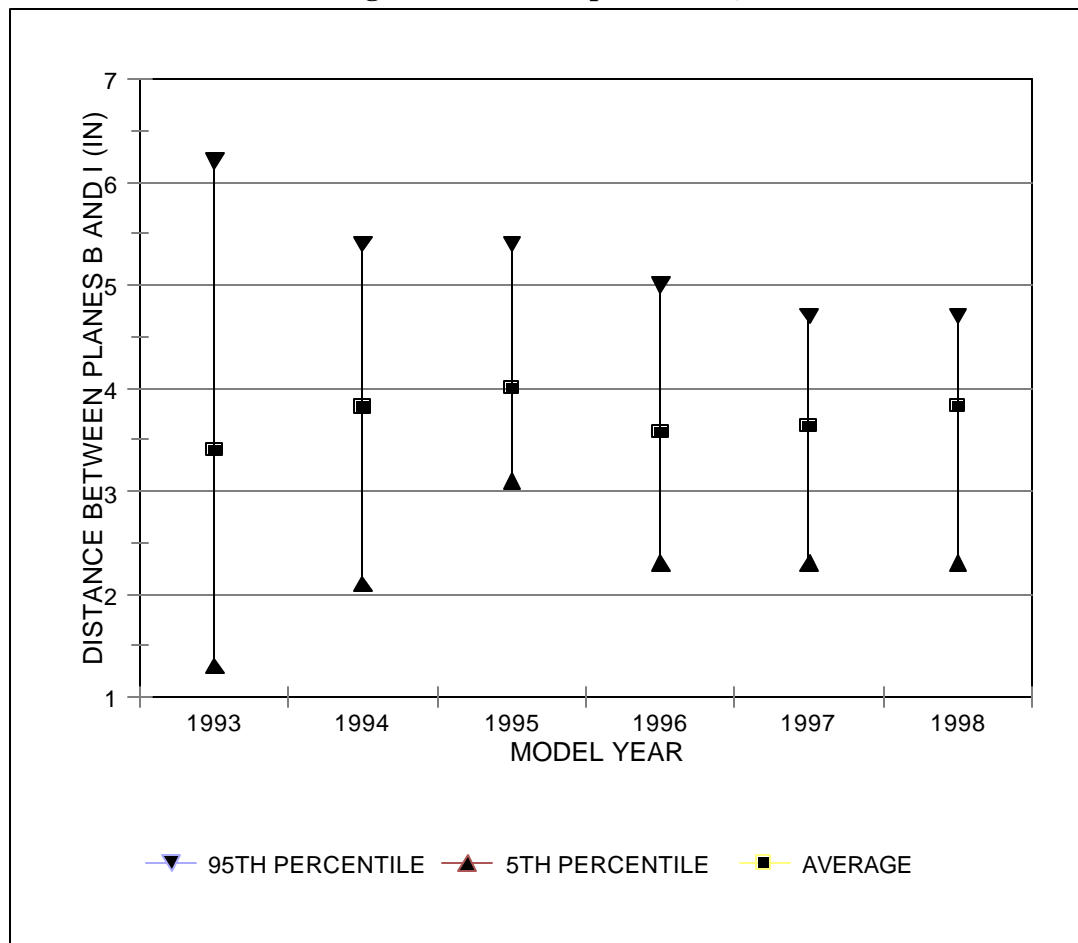
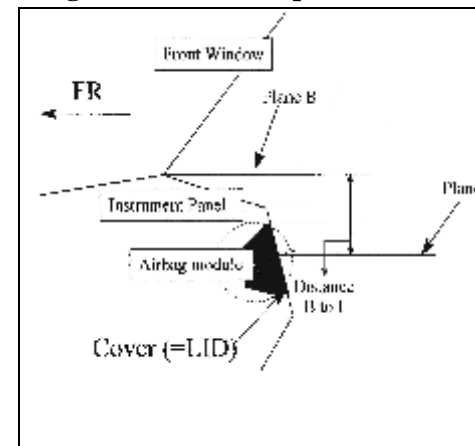

Diagram of Planes B and I for Air Bags Other than Top-Mounted



Definitions : Plane B is the horizontal plane tangent to the uppermost surface of the passenger portion of the instrument panel. Plane I is the horizontal plane that passes through the center point of the passenger air bag module.

Discussion: As depicted in the chart, the average distance between Planes B and I has fluctuated over the years. The average distance has ranged from 3.4 inches to 4.0 inches.

Passenger Side Air Bag: Distance between Planes H and I for Air Bags Other than Top-Mounted, 1993-1998

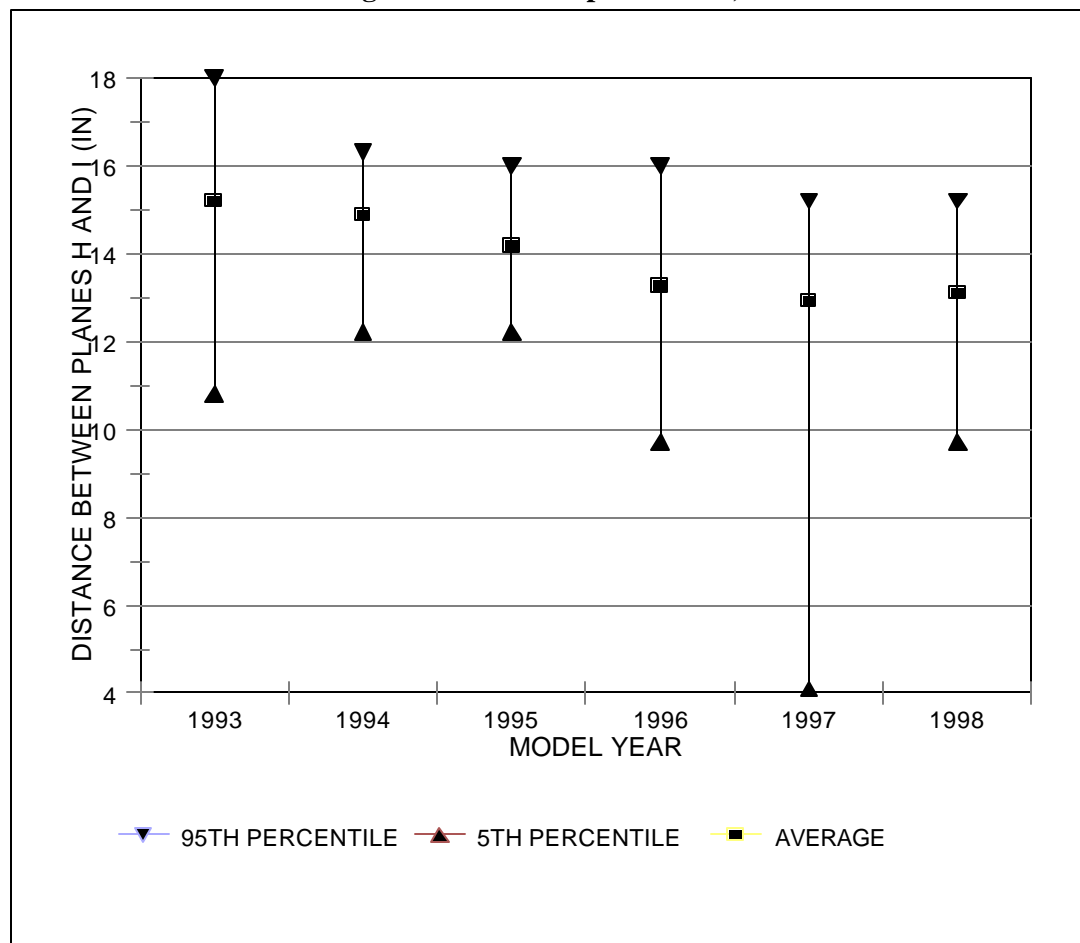
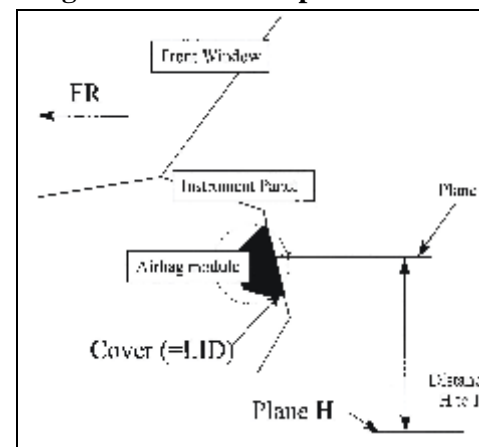

Diagram of Planes H and I for Air Bags Other Than Top-Mounted



Definition: Plane H is the horizontal plane that passes through the seating reference point (SRP) for the front outboard passenger seating position. Plane I is the horizontal plane that passes through the center point of the passenger air bag module.

Discussion: The average distance between Planes H and I has ranged from 15 inches in 1993 to 13 inches in 1998 placing the air bag module slightly lower on the instrument panel.

Passenger Side Air Bag: Distance between Plane C and Plane L for Top-Mounted Air Bags, 1993-1998

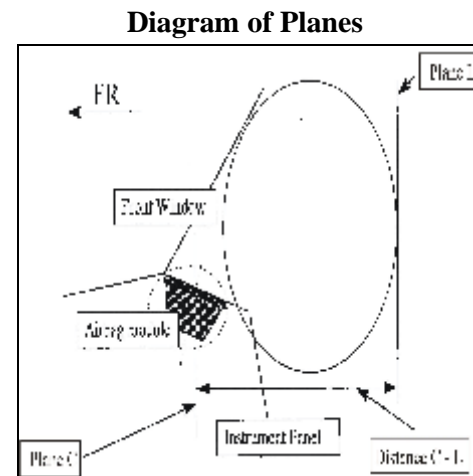
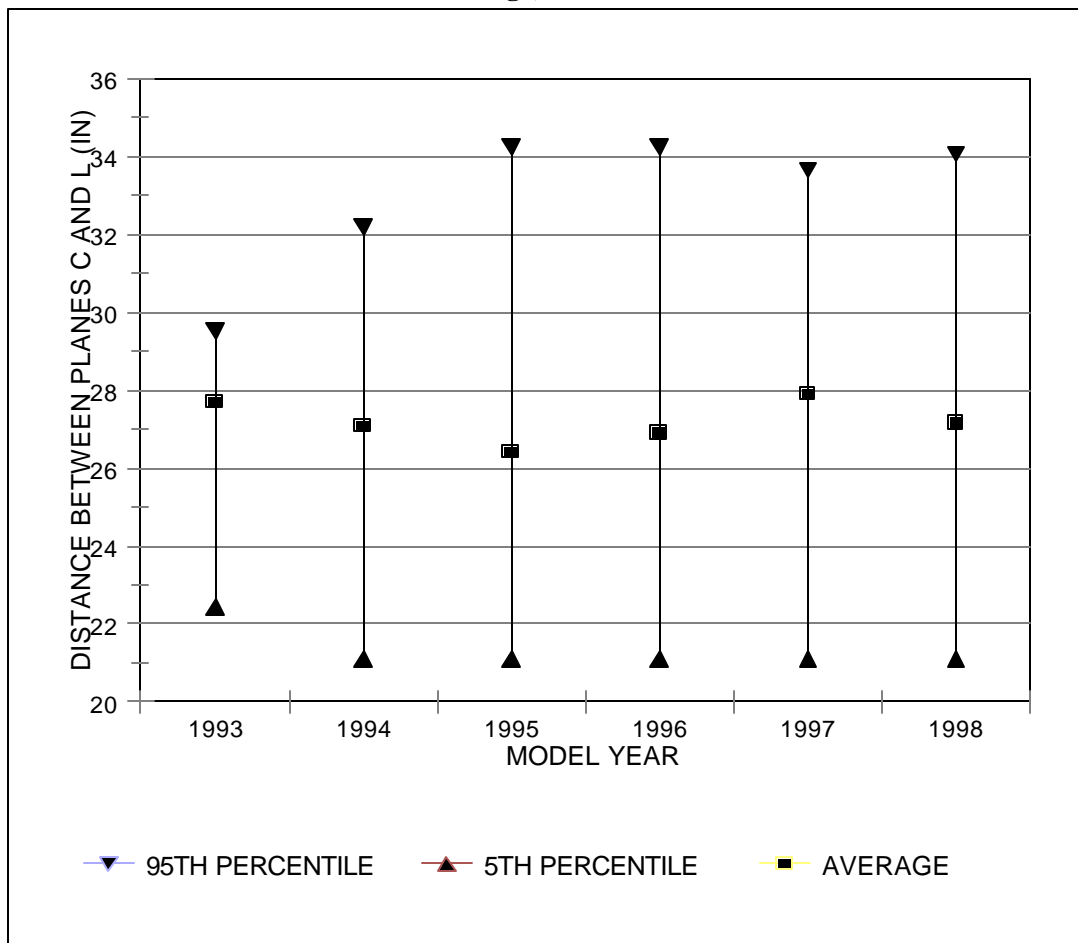

Definition: Plane C is the transverse vertical plane that passes through the center point of the passenger air bag cover. Plane L is the transverse vertical plane that passes through the maximum rearward point that the passenger air bag reaches at any time during deployment.

Discussion: The average rearward deployment distance of the top-mounted passenger air bag has been relatively consistent since 1993.

Passenger Side Air Bag: Distance between Plane D and Plane L for Air Bags Other Than Top-Mounted, 1993-1998

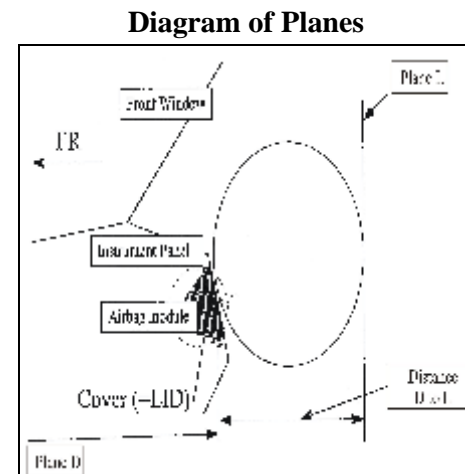
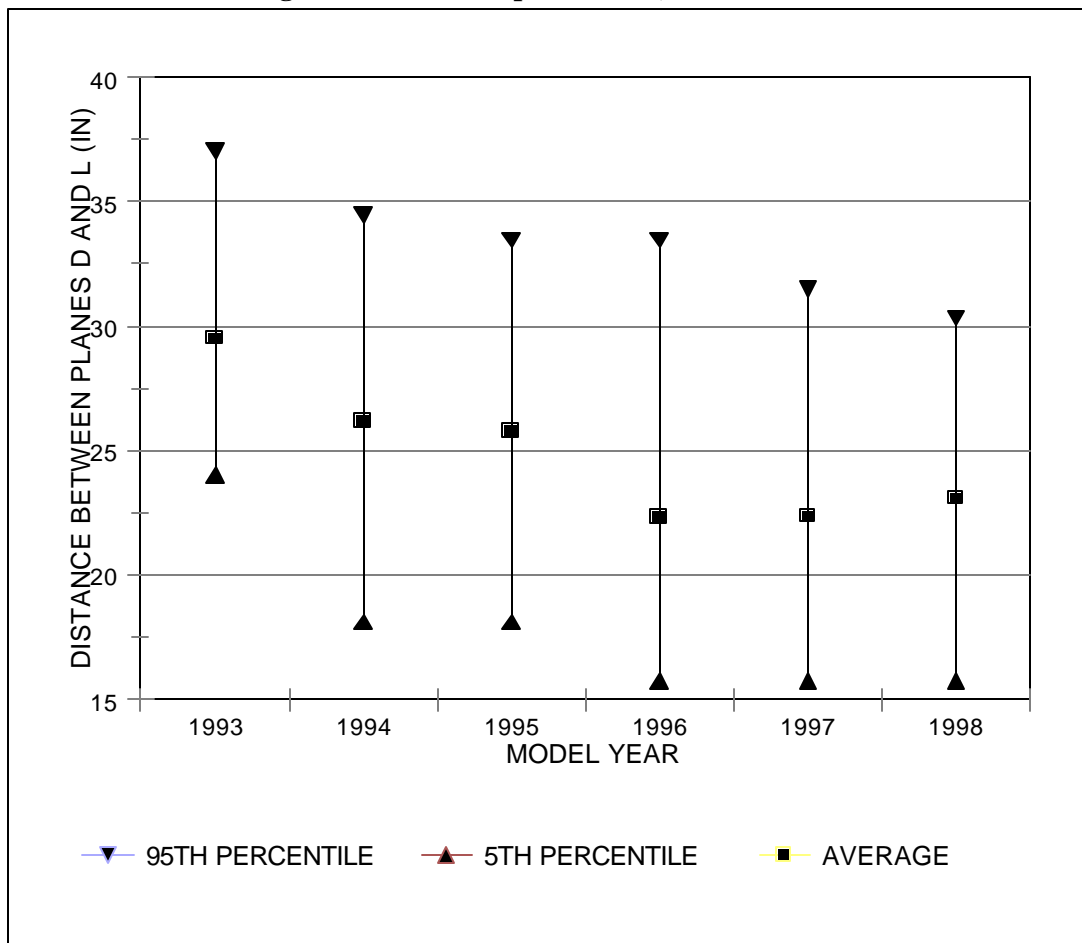

Definition: Plane D is the vertical plane tangent to the portion of the passenger air bag module closest to a normally seated front outboard passenger. Plane L is the transverse vertical plane that passes through the maximum rearward point that the passenger air bag reaches at any time during deployment.

Discussion: From 1993 to 1996, there was a substantial decrease (21 percent) in the average distance between Planes D and L. The average distance has remained basically the same since 1996.

**Passenger Side Air Bag: Distance between Plane G and Plane L
for Air Bags Other than Top-Mounted, 1993-1998**

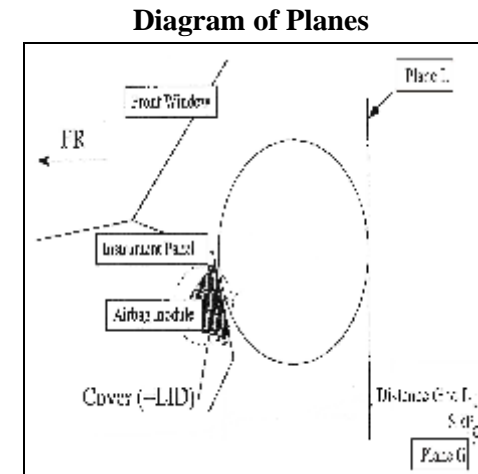
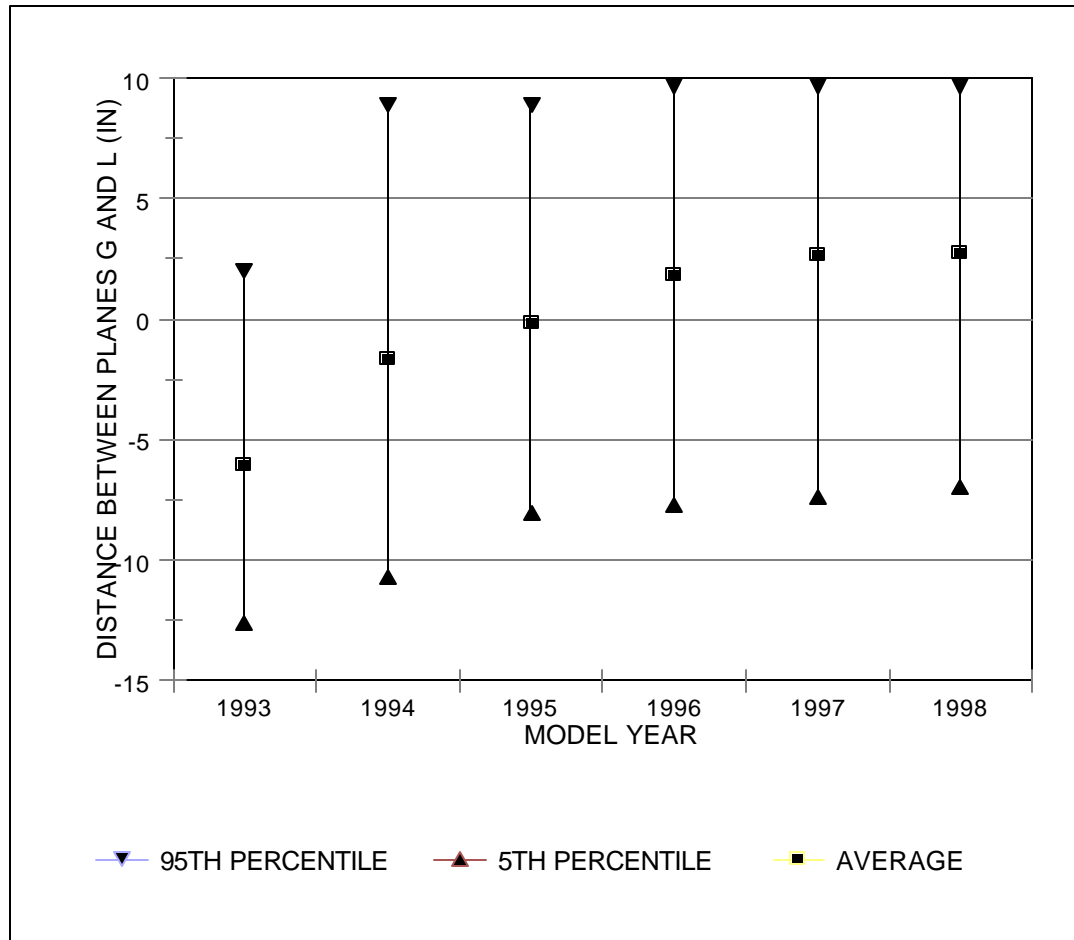

Definition: Plane G is the transverse vertical plane that passes through the SRP for the front outboard passenger seating position. Plane L is the transverse vertical plane that passes through the maximum rearward point that the passenger air bag reaches at any time during deployment.

Discussion: The chart shows a dramatic increase in the average distance between Planes G and L from 1993 to 1998. Data were not reported for one-fourth of the vehicles.

Passenger Side Air Bag: Maximum Distance the Air Bag Reaches Laterally on Each Side of Plane M, 1993-1998

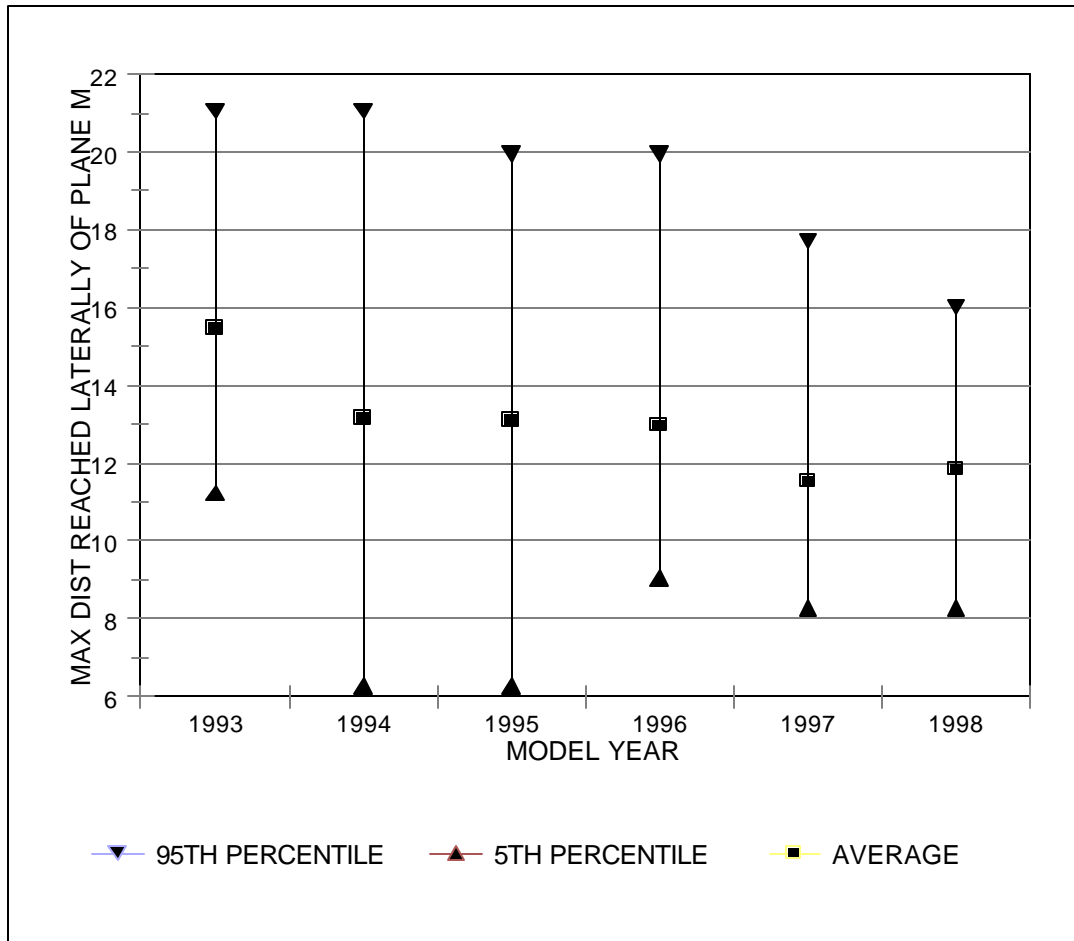

Definition: Plane M is the longitudinal vertical plane that passes through the centerline of the Hybrid III dummy as positioned at the passenger position.

Discussion: The chart shows a substantial decrease in the distance to which the air bag reaches laterally on either side of Plane M. Data were not reported for approximately 34 percent of the vehicles.

Driver Side Air Bag: Inflator Type, 1990-1998

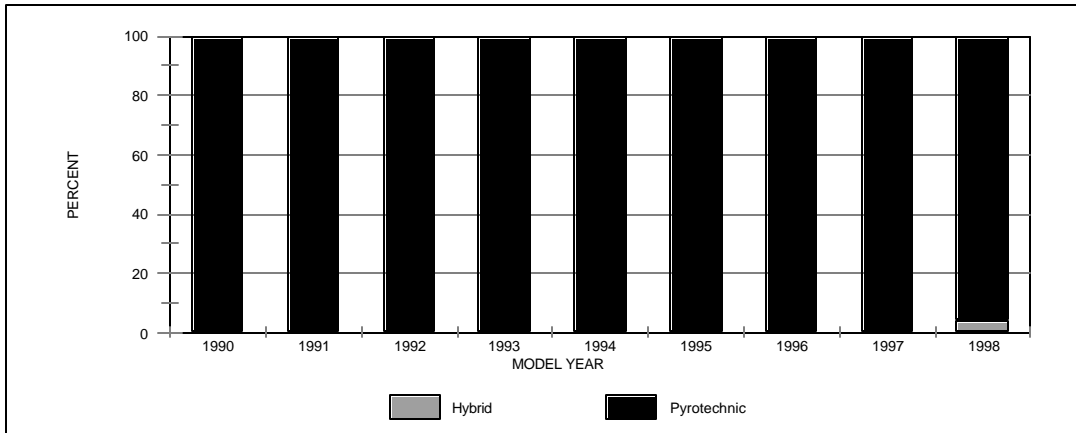

Passenger Side Air Bag: Inflator Type, 1993-1998

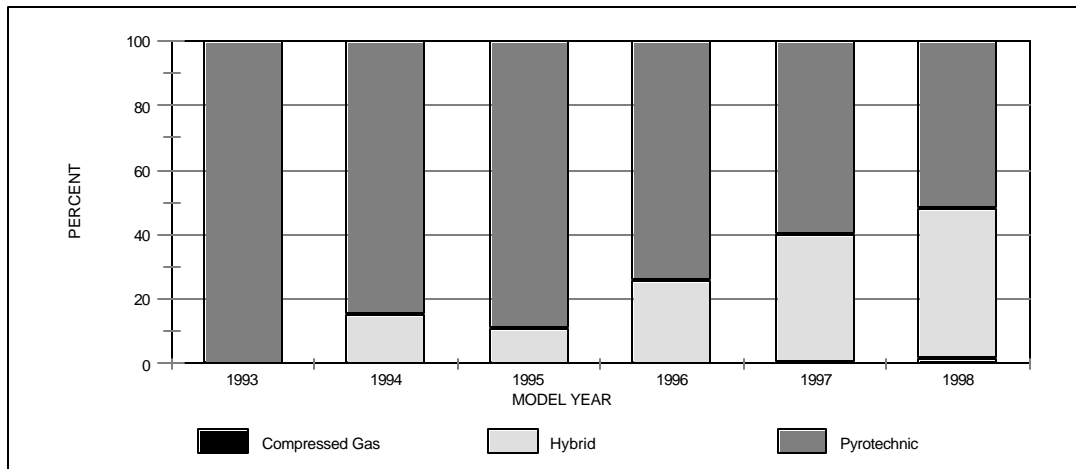

Definition: Air bag inflators can be broadly classified as Pyrotechnic, Compressed Gas, or Hybrid. Hybrid inflators are a combination of Pyrotechnic and Compressed Gas mechanisms.

Driver Side: One hundred percent of driver side inflators were pyrotechnic devices prior to 1997. Hybrid inflators started to appear in the fleet in 1997 (0.1 percent) and 1998 (4 percent).

Passenger Side: In 1993, 100 percent of the inflators in the fleet were Pyrotechnic. Hybrid inflators started to appear in 1994 (approximately 15 percent). From 1994 to 1998, there was a 31 percent increase in Hybrid inflators. Compressed gas inflators comprised a minor proportion of the inflators in 1997 and 1998.

Driver Side Air Bag: Inflating Agent, 1990-1998

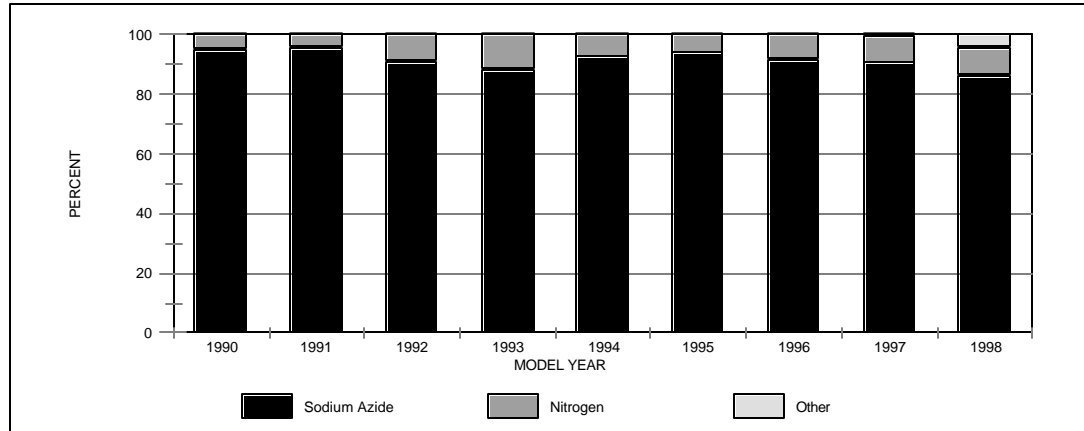

Passenger Side Air Bag: Inflating Agent, 1993-1998

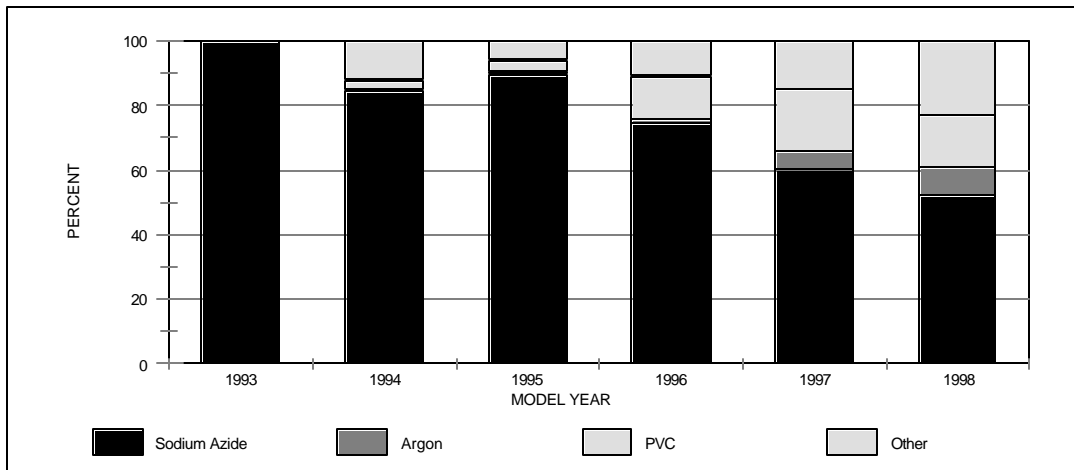

Definition: The inflating agent is the gas that is generated during the inflation process to fill the air bag.

Driver Side: The gas generated in the driver side air bag is predominantly sodium azide. A small percentage of inflators use nitrogen as the inflating agent. In 1998, several other inflating agents such as argon began to surface.

Passenger Side: Sodium azide has been the predominant gas generated in the inflators of passenger air bags for many years. Poly-vinyl chloride (PVC), argon, and other agents such as Hydrogen and Helium are showing increased presence as the gas generated in the inflators.

Driver and Passenger Side Air Bag: Number of Inflation Stages, 1990-1998

Definition: Inflation Stages can be single or multiple. Multiple Stage inflators maintain a reduced inflator output at the beginning of the inflation process and reach peak output at a later stage of deployment.

All of the Driver Side Air Bags from 1990 to 1998 and the Passenger Side Air Bags from 1993 to 1998 in the fleet had a single stage inflation process; therefore no chart is displayed to represent the number of air bag inflation stages.

Driver Side Air Bag: Scaled Rise Rate, 1990-1998

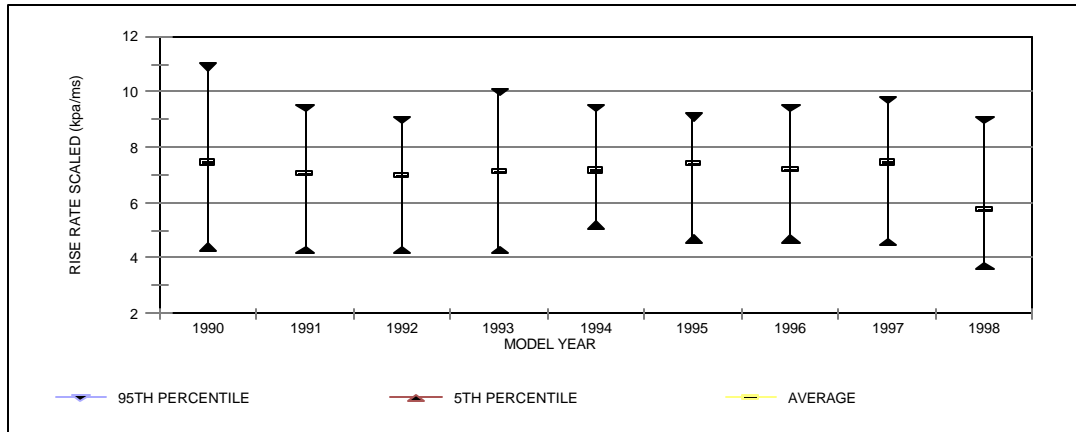

Passenger Side Air Bag: Scaled Rise Rate, 1993-1998

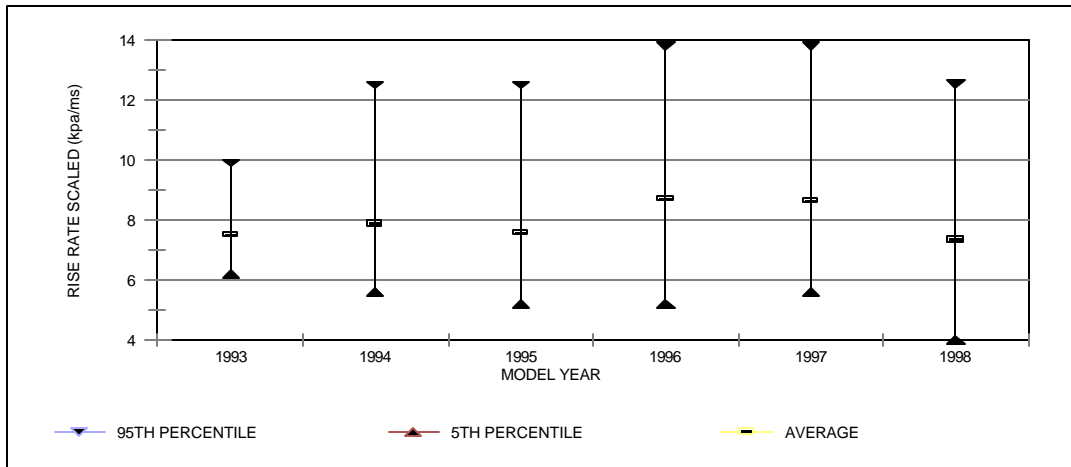

Definition: The scaled rise rate is the rate at which the air bag inflation pressure increases over time during tank tests.

Driver inflator tank test data were scaled to a 60 liter tank volume and the passenger tank test data were scaled to 100 liters using a constant PV product method.

Driver Side: Although the average scaled rise rate has fluctuated over the past several years, the average scaled rise rate decreased approximately 23 percent from 1997 (7.4 kpa/ms) to 1998 (5.7 kpa/ms).

Passenger Side: The average scaled rise rate in the passenger air bag has also fluctuated over the past several years. The average rise rate decreased approximately 14 percent from 1997 (8.6 kpa/ms) to 1998 (7.4 kpa/ms).

Driver Side Air Bag: Scaled Peak Pressure, 1990-1998

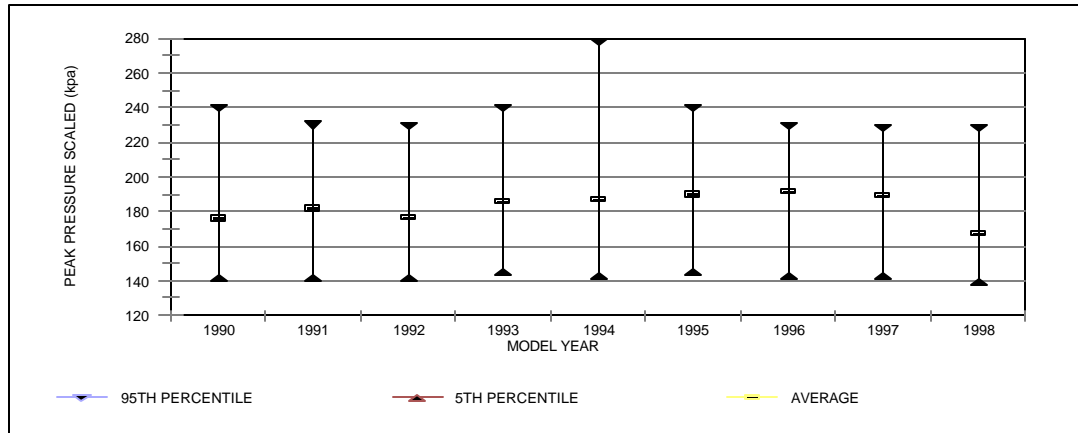

Passenger Side Air Bag: Scaled Peak Pressure, 1993-1998

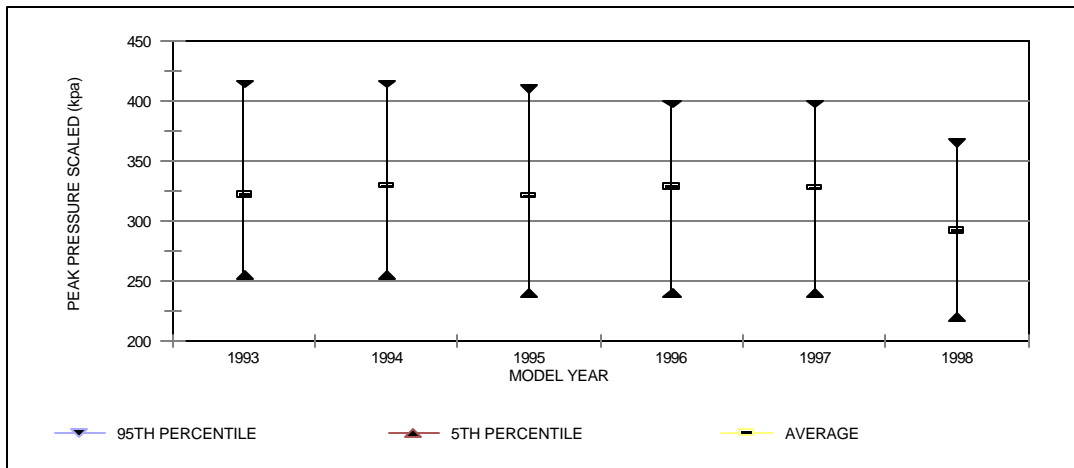

Definition: The scaled peak pressure is the maximum pressure attained during the air bag inflator tank tests.

Driver inflator tank test data were scaled to a 60 liter tank volume and the passenger tank test data were scaled to 100 liters using a constant PV product method.

Driver Side: The average scaled peak pressure decreased approximately 12 percent from 1997 (189 kpa) to 1998 (167 kpa).

Passenger Side: The average scaled peak pressure decreased approximately 11 percent from 1997 (328 kpa) to 1998 (292 kpa).

Driver Side Air Bag: Stiffness of the Seat Belts (force/elongation), 1990-1998

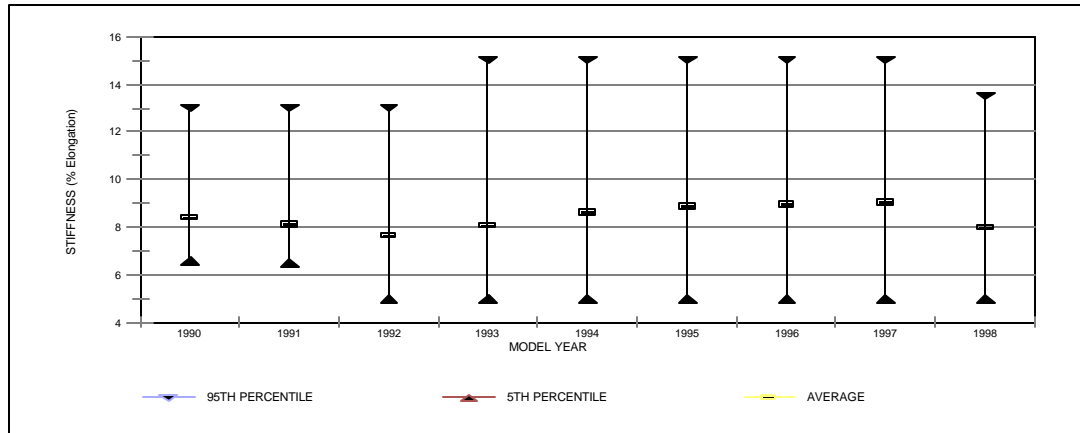

Passenger Side Air Bag: Stiffness of the Seat Belts (force/elongation), 1993-1998

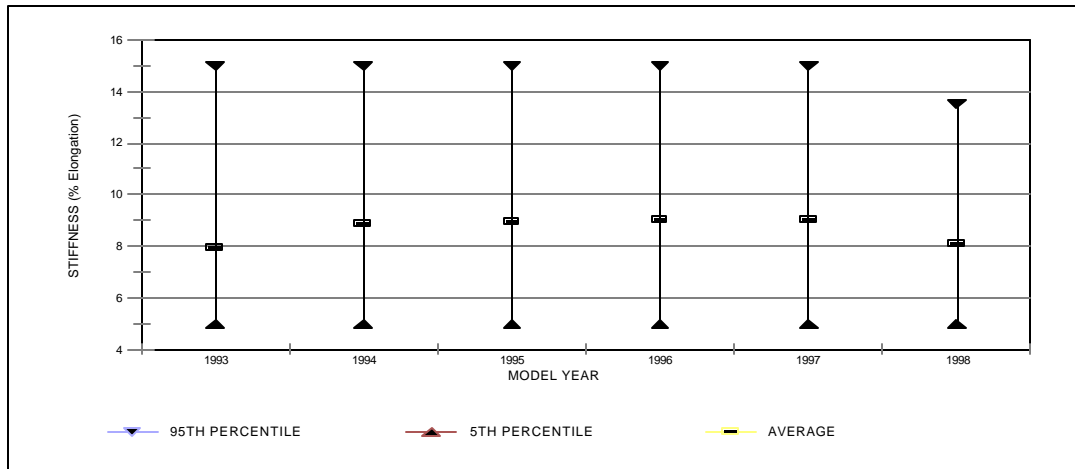

Definition: The stiffness of a seat belt is the amount (in percent) a seat belt stretches when subjected to a specific force. A low percent in elongation indicates a stiffer belt.

Driver Side: The average stiffness of the driver seat belt showed a steady decreasing trend from 1992 to 1997. In 1998, the driver seat belt became stiffer.

Passenger Side: The average stiffness of the passenger seat belt showed a decreasing trend from 1993 to 1994. From 1994 to 1997, the stiffness remained relatively constant. The passenger seat belt became stiffer in 1998.

Driver Side Air Bag: Presence of Load Limiters in the Seat Belt

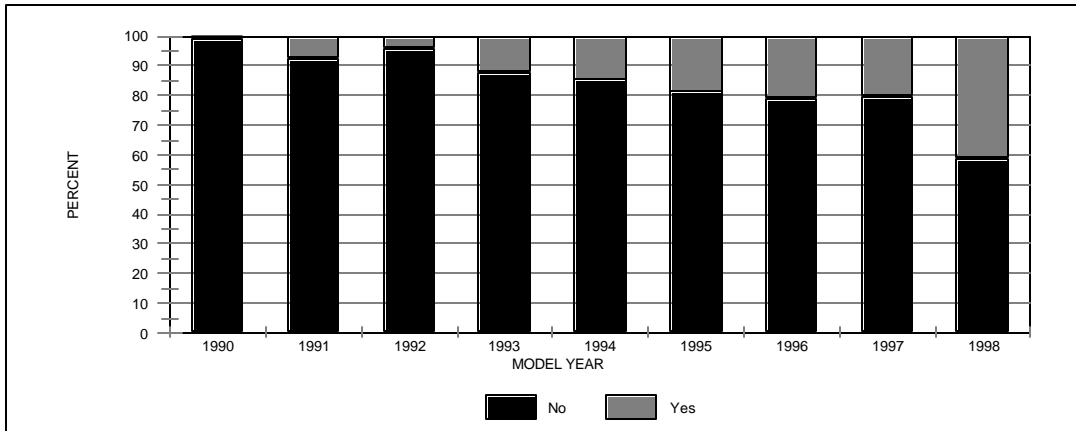

Passenger Side Air Bag: Presence of Load Limiters in the Seat Belt

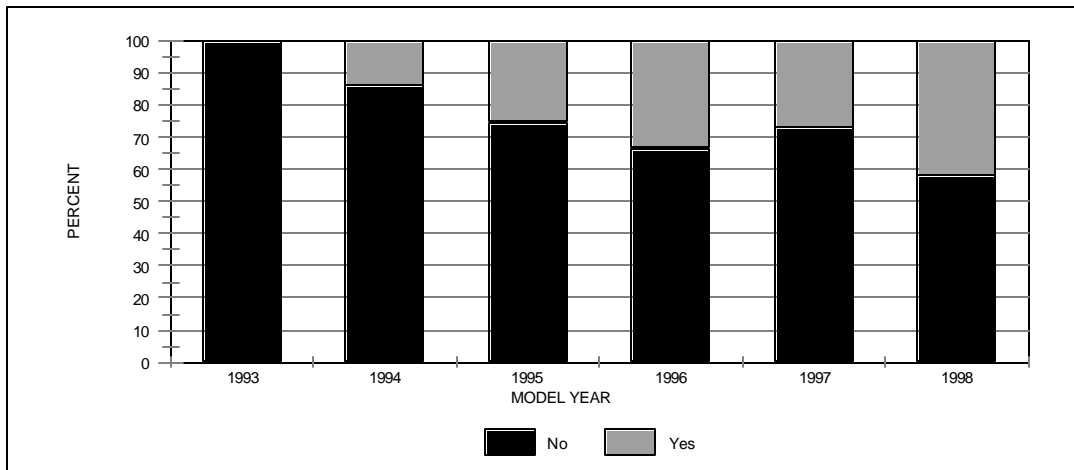

Definition: Load limiters are devices that limit the forces imparted to the occupant by the seat belt during the crash event. The forces are prevented from exceeding a pre-determined level by allowing the seat belt webbing to yield when forces reach this level.

Driver Side: In 1990, load limiters were present in just one percent of the fleet. In 1998, limiters were present in approximately 40 percent of the fleet.

Passenger Side: In 1994, load limiters were present in 14 percent of the fleet, however, by 1998, the percent of limiters present in seat belts had tripled to approximately 42 percent

Driver Side Air Bag: Presence of Pretensioners in the Seat Belt

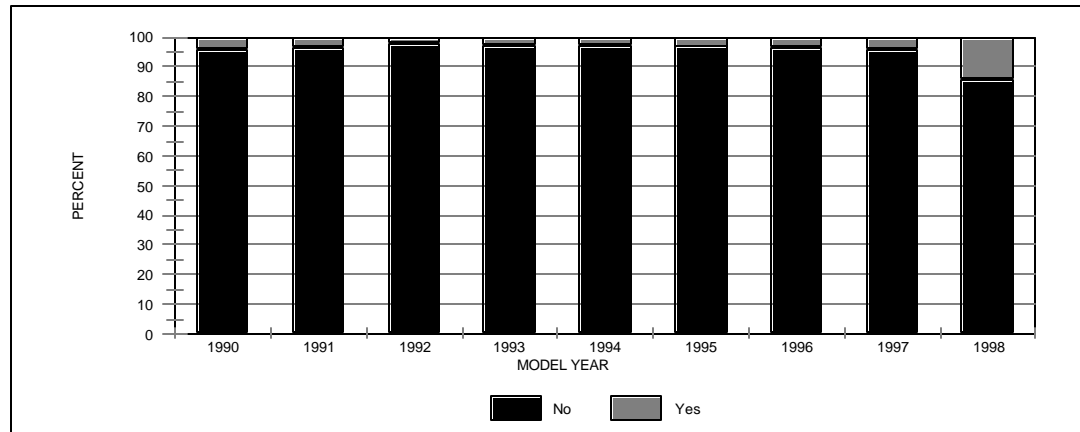

Passenger Side Air Bag: Presence of Pretensioners in the Seat Belt

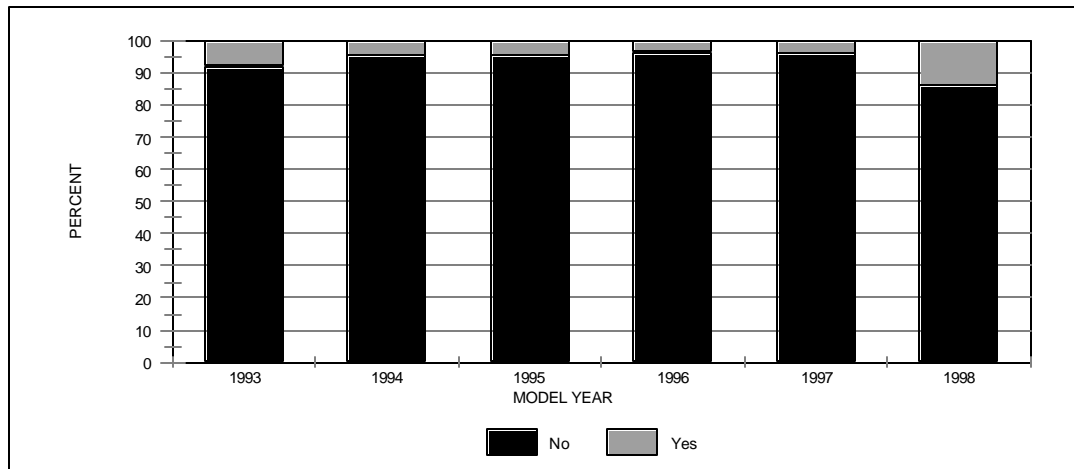

Definition: Pretensioners are devices, usually pyrotechnic, to remove slack from the seat belt upon air bag inflation.

Driver Side: Until 1997, pretensioners were present in a minor proportion of the vehicles. The proportion of seat belts with pretensioners increased from 4 percent in 1997 to 14 percent in 1998.

Passenger Side: The proportion of passenger seat belts with pretensioners showed a decreasing trend from 1993 to 1997. From 1997 to 1998, the proportion of seat belts with pretensioners increased from 4 percent to 14 percent.

Driver Side Air Bag: Presence of Web Clamps in the Seat Belt, 1990-1998

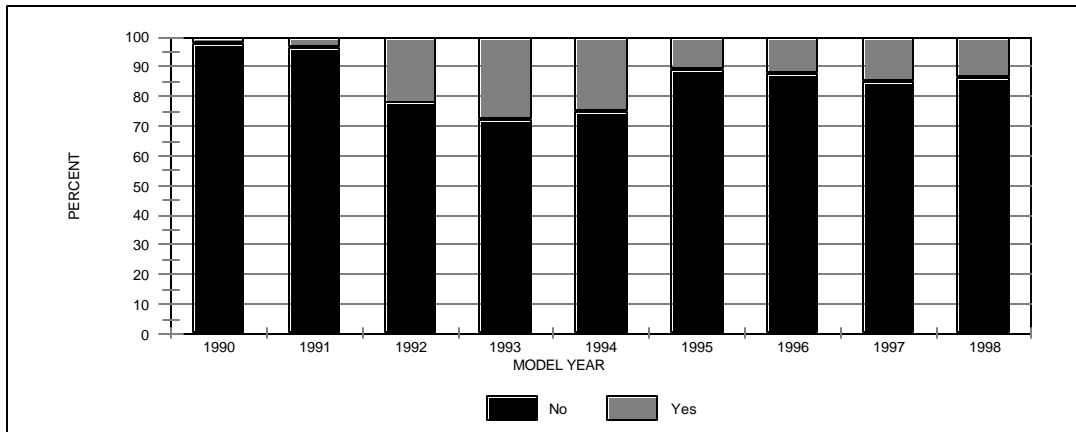

Passenger Side Air Bag: Presence of Web Clamps in the Seat Belt, 1993-1998

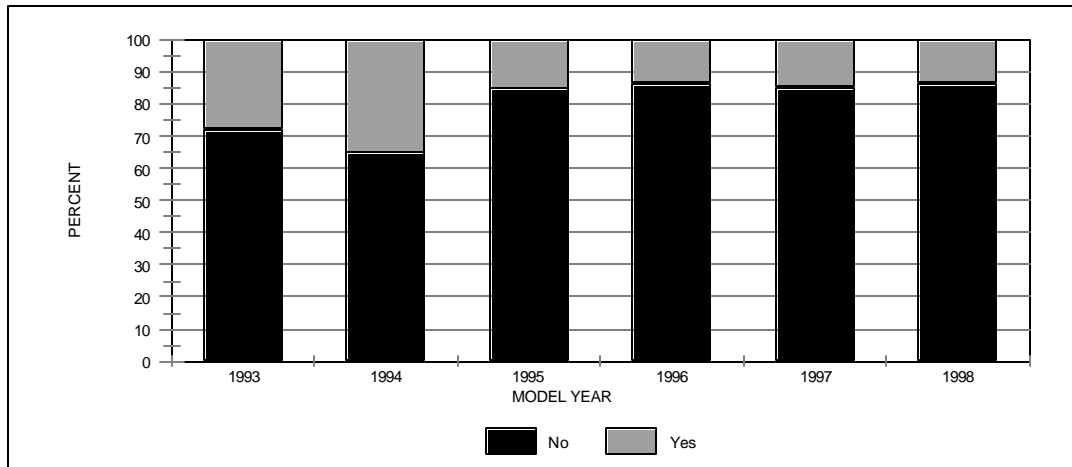

Definition: Web clamps are devices in the seat belt retractor that lock the webbing to prevent or minimize shoulder belt spool-out.

Driver Side: The proportion of seat belts with web clamps increased considerably from 1991 to 1992. Although the presence of web clamps in seat belts fluctuated slightly from 1992 to 1994, in 1995, web clamps in seat belt systems dropped considerably and has remained on the low side.

Passenger Side: The proportion of passenger seat belts with web clamps reached a high (35 percent) in 1994. In 1995, web clamps in seat belt systems dropped significantly and has remained on the low side.

Number of Sensors, 1990-1998

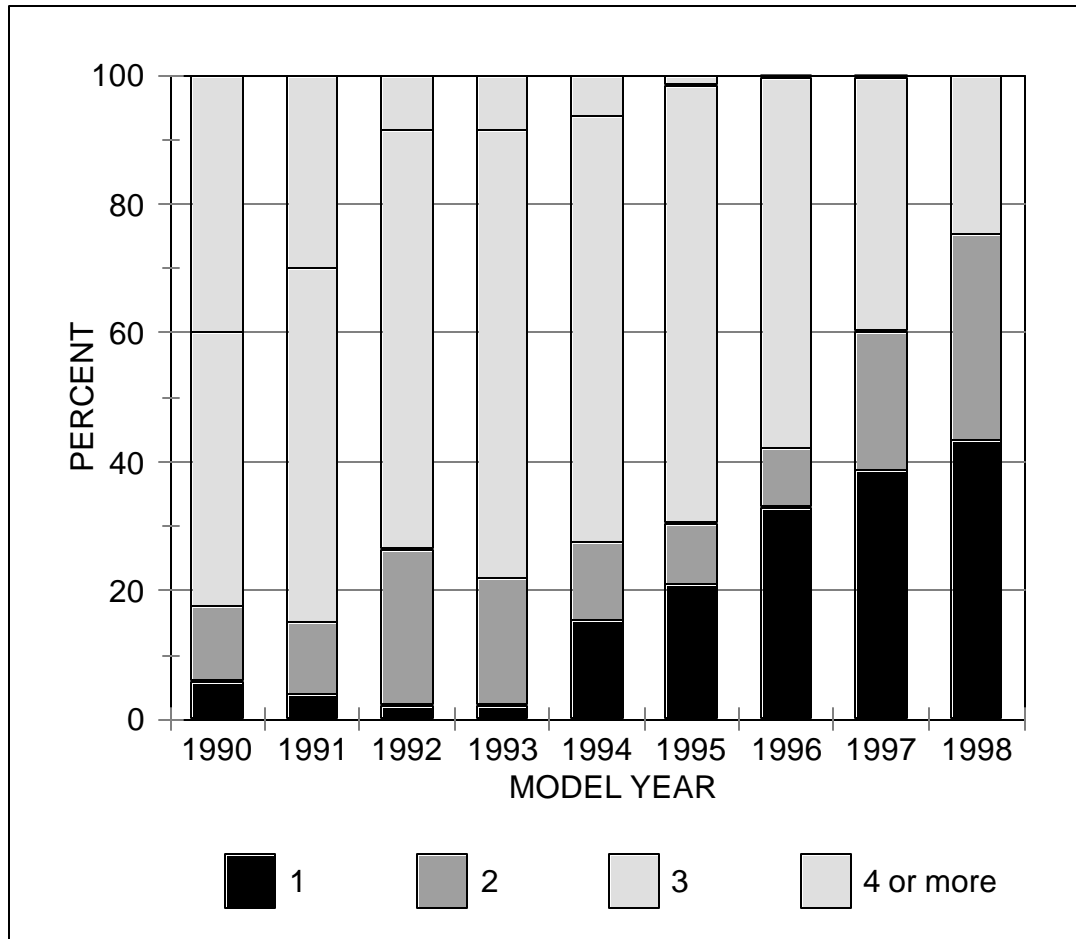

Definition: Sensors are devices that are designed to initiate air bag inflation upon crash impact.

Discussion:

The chart shows a trend towards a lower number of air bag sensors in vehicles. Until 1996, more than half the vehicles in the fleet had 3 or more sensors. In 1998, approximately 44 percent of the vehicles had just one sensor. The proportion of vehicles having two air bag sensors has also grown in recent years.

Location of Sensors, 1990-1998

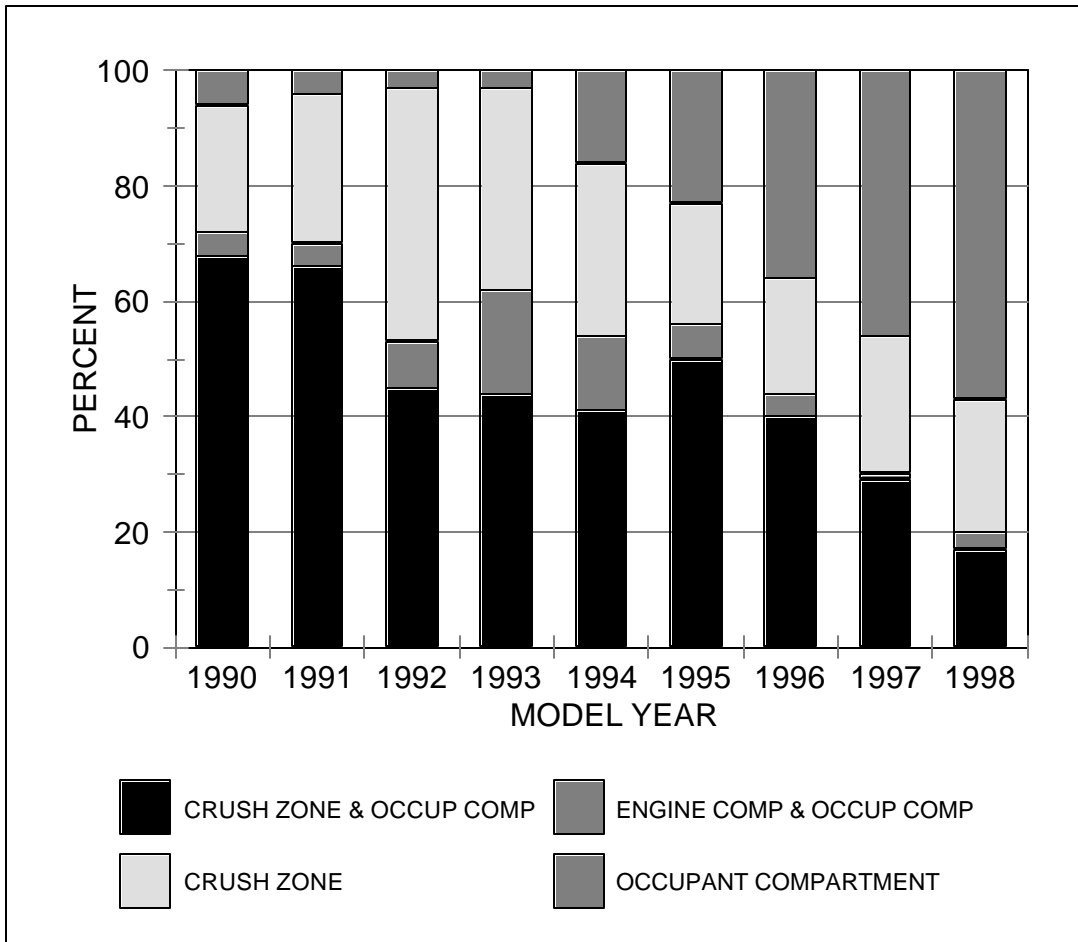

Definition: Crash Sensors are typically located in the:

- (a) Crush Zone which is approximately the front two feet of the vehicle;
- (b) Engine Compartment;
- (c) Occupant Compartment which is usually the tunnel or the console between the two front seats; or,
- (d) Air Bag Module (for all mechanical systems).

Discussion: The chart shows a trend towards the sensors being located in the occupant compartment. For the past several years, sensors located in the crush zone and occupant compartment and in the engine and occupant compartments have been decreasing. The percentage of sensors located in the crush zone only has remained about the same since 1995.

Type of Sensors, 1990-1998

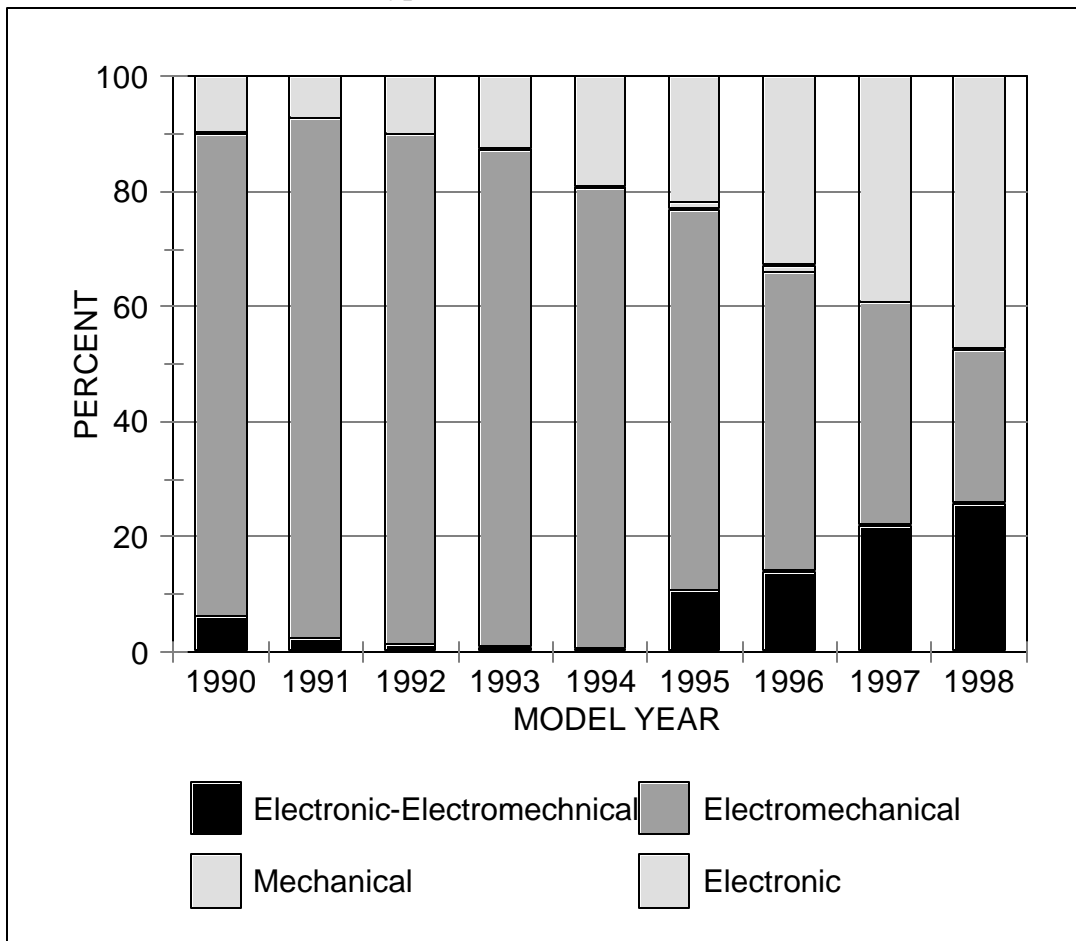

Definition: The type of sensors falls into four broad categories:

- (a) Electronic-Electromechanical which is a combination of Electronic and Electromechanical sensors;
- (b) Electronic Sensors;
- (c) Electromechanical Sensors; and
- (d) Mechanical Sensors.

Discussion: Although electromechanical air bag sensors had been the predominant sensor for many years, such sensors have begun to decrease. From 1995 to 1998, the proportion of sensors that are electronic or electronic-electromechanical has doubled. In 1998, electronic and electronic-electromechanical sensors accounted for approximately 73 percent of the sensor types.

Appendix B. Manufacturer Information Request

[MANUFACTURER]

Re: Air bag technology in light passenger vehicles

Dear [Manufacturer]

As you are aware, the National Highway Traffic Safety Administration (NHTSA) plans to amend the automatic restraint requirements of Federal Motor Vehicle Safety Standard (FMVSS) No. 208, "Occupant Crash Protection," to require the installation of advanced air bags. NHTSA also continues to review the progress of air bag technology and monitor the effects of its recent rulemaking action to depower air bags (62 FR 12960; March 19, 1997). In support of these various undertakings, NHTSA hereby requires [Manufacturer] to respond to the enclosed Information Request, issued pursuant to 15 U.S.C. § 30117(a).

Subsection (a) of Section 30117 authorizes the Secretary of Transportation "to require that each manufacturer of a motor vehicle . . . provide technical information related to performance and safety required to carry out [Chapter 301 of Title 49, United States Code]." These functions have been delegated to NHTSA. 49CFR 1.50.

[Manufacturer] must respond to the enclosed Information Request, in accordance with the instructions contained therein, by February 17, 1998. Failure to respond promptly and fully to this Information Request could subject [Manufacturer] to civil penalties pursuant to 49 U.S.C. § 30163.

NHTSA is aware that the holiday period is about to begin and that many manufacturers will be shut down for some or all of that period. The agency has taken this fact into consideration in setting the 60-day deadline for responding to this Information Request.

If you have any technical questions concerning this Information Request, please contact Mr. James R. Hackney, Director, Office of Crashworthiness, at (202) 366-1740. If you have any legal questions concerning this Information Request, please contact Mr. J. Edward Glancy of the Office of Chief Counsel at (202) 366-2992.

Sincerely

/s/ James R. Hackney for

L. Robert Shelton
Associate Administrator
For Safety Performance Standards

Enclosure

INFORMATION REQUEST

Re: Air Bag Technology in Light Passenger Vehicles

To: [Manufacturer]

I. Instructions

- A. Each specification in this Information Request must be answered separately and fully, in writing. Above each answer, the text of the applicable specification must be provided.
- B. The information provided in response to this Information Request must be derived from any and all information which is known to, or in the possession of [Manufacturer] . [Manufacturer] is not required to conduct any tests or physical measurements to respond to the specifications in this Information Request. However, [Manufacturer] is required to perform any calculations or analyses necessary to derive responses to the specifications in this Information Request from documents or other data already in {[Manufacturer's]}' possession.
- C. All documents furnished in response to this Information Request must be marked with the number of the specification to which they respond. If [Manufacturer] cannot respond to any specification or portion thereof, please state the reason why it is unable to do so.
- D. If [Manufacturer] changed product configurations or suppliers during the course of a particular model year, state the effective date of any such change and answer all applicable specifications separately for each such configuration or supplier.
- E. All measurements furnished in response to the specifications in this Information Request shall be stated in metric units.
- F. Unless otherwise specified, [Manufacturer] shall respond to the specifications of this Information Request by providing information with respect to both driver and right front passenger seating positions.
- G. If [Manufacturer] withholds any requested information from its response to this Information Request because of attorney-client or any other privilege, or for any other reason, it must furnish a description of each document or item of information withheld, and state the basis for such withholding.
- H. If [Manufacturer] claims that any of the information submitted in response to this Information Request constitutes confidential commercial material within the meaning of 5 U.S.C. § 552(b)(4), or is protected from disclosure pursuant to 18 U.S.C. § 1905, an affidavit must be provided in support of each such claim, including a statement of the competitive harm that [Manufacturer] believes would occur if the information were released to the public.
- I. [Manufacturer] must submit three copies of its response to this Information Request to this office by February 17, 1998. If [Manufacturer] considers any portion of its response to be confidential information, include that material in a separate enclosure marked "Confidential." In addition,

[Manufacturer] must submit a copy of all such material to the Office of Chief Counsel (NCC-30), National Highway Traffic Safety Administration, 400 Seventh Street, SW, Washington, DC 20590, and comply with all other requirements for the submission of confidential business information stated in 49 CFR Part 512.

II. Definitions

For purposes of this Information Request, the following definitions apply:

- A. “Air bag” means an inflatable restraint installed at the driver or front outboard passenger seating position to provide occupant protection in frontal crashes.
- B. “Air bag module” means the portion of an air bag system that includes the folded air bag and inflator, but does not include the air bag cover.
- C. “[Manufacturer]” means [Manufacturer], its divisions, subsidiaries, and joint ventures, and all officers, employees, agents, contractors, and consultants, past or present, of these entities.
- D. “Longitudinal vertical plane” means a vertical plane that is parallel to the longitudinal centerline of the vehicle.
- E. “Passenger portion of the instrument panel” means that portion of the instrument panel defined by a forward projection of the widest portion of the Hybrid III dummy, as positioned at the front outboard passenger seating position for a Standard 208 barrier test.
- F. “Plane A” means the plane tangent to the face of the steering wheel rim. For the purpose of locating that plane, an adjustable steering wheel is positioned as specified for a Standard 208 barrier test.
- G. “Plane B” means the horizontal plane tangent to the uppermost surface of the passenger portion of the instrument panel.
- H. “Plane C” means the transverse vertical plan that passes through the center point of the passenger air bag cover.
- I. “Plane D” means the transverse vertical plane tangent to the portion of the passenger air bag module closest to a normally seated front outboard passenger.
- J. “Plane E” means the transverse vertical plane tangent to the rearmost portion of the passenger portion of the instrument panel.
- K. “Plane F” means the transverse vertical plane that passes through the SRP for the driver position.
- L. “Plane G” means the transverse vertical plane that passes through the SRP for the front outboard passenger seating position.
- M. “Plane H” means the horizontal plane that passes through the SRP for the front outboard

passenger seating position.

- N. "Plane I" means the horizontal plane that passes through the center point of the passenger air bag module.
- O. "Plane J" means the transverse vertical plane that passes through the center point on the surface of the driver air bag cover. For the purpose of locating that plane, an adjustable steering wheel is positioned as specified for a Standard 208 barrier.
- P. "Plane K" means the transverse vertical plane that passes through the maximum rearward point that the driver air bag reaches at any time during deployment. For the purpose of locating that plane, an adjustable steering wheel is positioned as specified for Standard 208 barrier test.
- Q. "Plane L" means the transverse vertical plane that passes through the maximum rearward point that the passenger air bag reaches at any time during deployment.
- R. "Plane M" means the longitudinal vertical plane that passes through the centerline of the Hybrid III dummy, as positioned at the driver position for a Standard 208 barrier test.
- S. "Plane N" means the longitudinal vertical plane that passes through the centerline of the Hybrid III dummy, as positioned at the front outboard passenger seating position for a Standard 208 barrier test.
- T. "Record" means any and all information maintained by [Manufacturer], either in hard copy format or in electronic storage media.
- U. "Seating Reference Point" or "SRF" has the meaning specified in 49 CFR Part 571.3.
- V. "Standard 208," means Federal Motor Vehicle Safety Standard No. 208, as in effect (with applicable amendments) for vehicles manufactured during the model year covered by a response.
- W. "Transverse vertical plane" means a vertical plane that is perpendicular to the longitudinal centerline of the vehicle.

III. Specifications

Please provide the following information, by model year, for each vehicle make/model that [Manufacturer] manufactured in or imported into the United States, in model years 1990-1998:

A. Information about air bag location, mounting and deployment direction:

1. Location and type of mounting:

a. For driver air bags:

- (1) State whether the air bag module is recessed, flush, or protruded from Plane A, relative to the driver.

- (2) Provide the closest distance from Plane A to the portion of the air bag module closest to the driver;
 - (3) Indicate whether the air bag module is designed to move away from the occupant at the time of deployment and, if so, how far.
- b. For passenger air bags:
- (1) State whether the air bag is mounted at the top, middle or bottom of the instrument panel. (If the mounting of the air bag cannot appropriately be described in this manner, please explain why and provide a verbal description of the mounting.)
 - (2) For top-mounted air bags, provide the distance from Plane C to Plane E.
 - (3) For air bags other than top-mounted air bags, provide the distance between Plane B and plane I, and between Plane H and Plane I.
 - (4) Indicate whether the air bag module is designed to move away from the occupant at time of deployment and, if so, how far.
2. Direction of deployment (passenger air bags only):
- a. State the primary initial gas flow vector as measured in degrees from a horizontal plane.
 - b. Describe the primary initial direction of deployment, e.g., vertical, horizontal or the approximate number of degrees from a horizontal plane.

B. Information about air bag cover configuration and opening during deployment.

1. State the size of the opening, providing both the dimensions of the opening and the area of the surface of the cover.
2. State the minimum breakout pressure.
3. State the mass of the cover.
4. Provide a verbal description and/or an illustration of the tear pattern.

C. Information about air bag system components.

1. Air bag
 - a. State the number of chambers
 - b. Provide a verbal description and/or an illustration of the fold pattern.
 - c. State the material of the bag and the total mass of that material.
 - d. State the inflation time, from initiation of inflation until full inflation.

- e. State the volume of the fully inflated air bag.
 - f. State the number and the location of the tethers.
 - g. Driver air bag deployment distance:
 - (1) State the distance between Plane J and Plane K.
 - (2) State the distance between Plane F and Plane K, and indicate which plane is forward of the other.
 - (3) State the maximum distance the air bag reaches, laterally on each side of Plane N, at any time during deployment.
 - h. Passenger air bag deployment distance:
 - (1) For top-mounted air bags, state the distance between Plane C and Plane L.
 - (2) For air bags other than top-mounted air bags, state the distance between Plane D and Plane L.
 - (3) For all passenger air bags, state the distance between Plane G and Plane L, and indicate which plane is forward of the other.
 - (4) For all passenger air bags, state the maximum distance the air bag reaches, laterally on each side of Plane M, at any time during deployment.
2. Information about the inflator
- a. State (answer yes or no to each) whether the inflator is (1) pyrotechnic, (2) compressed gas, or (3) hybrid, and specify the gas generant.
 - b. State the number of inflation stages.
 - c. Provide the following information with regard to inflator characteristics during a tank test to measure inflator performance.
 - (1) Tank volume.
 - (2) Initial absolute pressure in tank (pre-firing).
 - (3) Temperature (pre-firing).
 - (4) Tank pressure versus time.
 - d. Identify (name and address) the supplier of the inflator.

D. Information about the seat belts.

1. Describe the stiffness of the seat belts, i.e., the force/elongation characteristics.
2. State whether load limiters are present or absent. If present, state the load limiting force level.
3. State whether there are pretensioners. If so, state the number and type of pretensioners used and describe their location relative to the belt system.
4. State whether there is a web clamp.

E. Information about the crash sensors and crash sensor control logic.

1. State the number of sensors in each vehicle, and describe the location of each, e.g., occupant compartment, firewall, or crush zone.
2. Describe the type of sensors used, i.e., electromechanical, electronic, or other. If other, please identify and describe.
3. Identify (name and address) the supplier(s) of the sensors.
4. Identify (name and address) the supplier of the algorithm.
5. State the engineering specifications provided to suppliers for development of the algorithm. Define the crash conditions and time-to-fire requirements used to develop the algorithm, including, at a minimum, the nominal deployment threshold for each crash condition; the no-fire point for each crash condition; and the all-fire point for each crash condition.

F. Other system elements.

1. State whether the system contains any of the following components:
 - a. weight sensor
 - b. buckle sensor
 - c. child seat sensor
 - d. seat position sensor
 - e. on/off switch
 - f. inflatable knee bolster
 - g. pre-crash sensor
2. Identify (name and address) the supplier of every component identified in response to

Specification F.1.

G. System performance evaluations

1. For each of the following tests, provide the test speeds, and the head, neck, chest, and femur responses:
 - a. All belted/unbelted rigid barrier crash tests conducted to ensure compliance with Standard 208.
 - b. All tests conducted to ensure compliance with the Standard 208 alternative sled test.
 - c. All belted/unbelted rigid barrier crash tests conducted under test procedures substantially similar to those of Standard 208.
2. For each out-of-position (dummy) test, including but not limited to ISO tests and pendulum tests, state the test conditions and procedures and provide the head, neck, chest and femur responses.
3. For each offset crash test, state the test conditions and procedures and provide the head, neck, chest, and femur responses.

Appendix C. Tank Test Vessel



Appendix D. Supporting Data for the Out-of-Position and Barrier Testing

Out-Of-Position Dummy Set Up

Driver Air Bag Tests: As shown in Figure D-1, Position 1 for the adult dummy places the chin just above the air bag module; while Position 2 centers the sternum on the module. The Position 1 tests for adult dummies are intended to maximize loading to the head and neck, resulting in higher risk of neck injuries. The Position 2 tests are intended to maximize loading to the chest, resulting in higher risk of thoracic injuries.

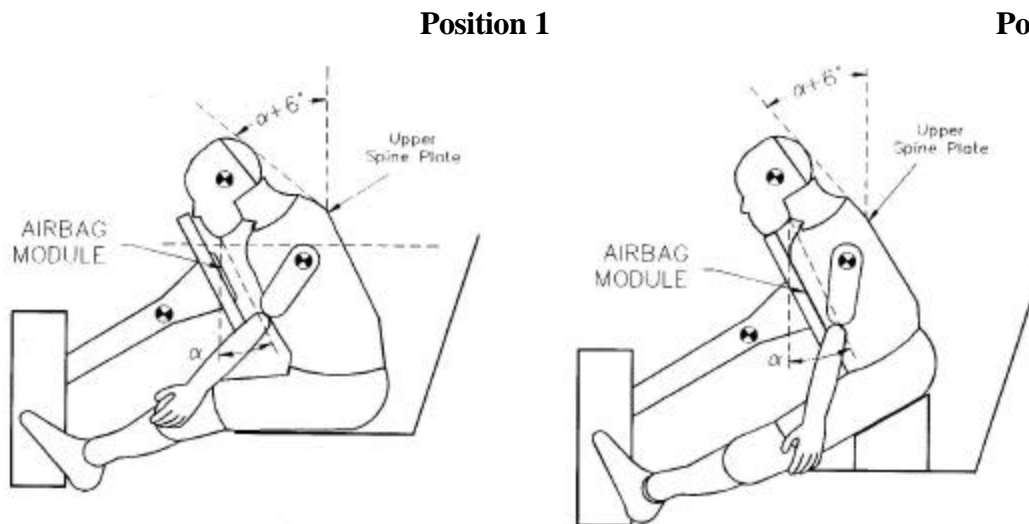

Figure D-1. Dummy Positioning for Driver Side Out-of-Position Testing with 5th Percentile Female Dummy.

Passenger Air Bag Tests: As shown in Figure D-2, Position 1 for the child dummy places the chest against the middle section of the dash, while Position 2 places the head between the middle and upper portions of the dash. The Position 1 tests for the child dummies are intended to maximize loading to the chest, resulting in higher risk of thoracic injuries. The Position 2 tests are intended to maximize loading to the head and neck, resulting in higher risk of neck injuries.

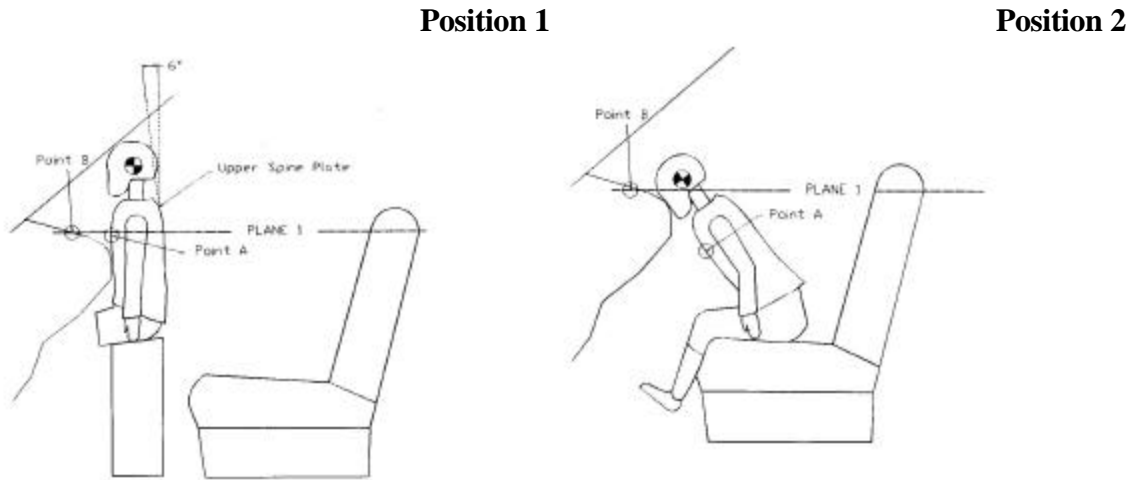

Figure D-2. Dummy Positioning for Passenger Side Out-of-Position Testing with 6-Year-Old Child Dummy.

Out-Of-Position Test Data

Driver Air Bag Test Data

Table D-1. Results for Driver Side Out-of-Position Testing with 5th Percentile Female Dummy--Position 1				
Model	15 ms HIC	SNPRM Nij	Chest Acceleration (Gs)	Chest Deflection (mm)
IARV	700	1.00	60.0	53.0
96 Camry	70	0.71	16.3	19.5
96 Neon	69	2.12	28.4	29.6
96 Taurus	136	1.01	24.0	30.2
96 Explorer	85	2.79	25.0	27.6
96 Average	90	1.66	23.4	26.7
98 Accord	N/A	1.28	15.0	18.6
98 Camry	30	1.30	15.1	19.4
98 Neon	32	1.77	23.6	26.3
98 Taurus	33	1.64	15.4	16.7
98 Explorer	16	1.23	14.3	18.6
98 Average	28	1.44	16.7	19.9
99 Saturn SL	28	0.27	20.2	26.2
99 Toyota PU Buck	107	1.16	22.0	22.5
99 Econoline Van	13	0.97	13.5	22.3
99 Acura RL	220	1.32	17.7	29.9
99 Expedition	8	0.98	11.1	19.9
99 Intrepid Buck	24	0.70	24.4	27.3
99 Average	67	0.90	18.2	24.7

Table D-2. Results for Driver Side Out-of-Position Testing with 5th Percentile Female Dummy--Position 2

Model	15 ms HIC	SNPRM Nij	Chest Acceleration (Gs)	Chest Deflection (mm)
IARV	700	1.00	60.0	53.0
96 Camry	28	0.76	18.0	29.4
96 Neon	160	2.30	31.6	43.3
96 Taurus	NA	1.14	20.9	1.7
96 Explorer	32	2.22	36.4	39.8
96 Average	73	1.60	26.7	28.5
98 Accord	60	0.68	26.2	45.1
98 Camry	28	0.82	31.7	32.9
98 Neon	25	0.56	34.1	34.4
98 Taurus	14	1.00	27.6	38.7
98 Explorer	8	1.08	14.0	22.3
98 Average	27	0.83	26.7	34.7
99 Econoline Van	8	0.29	24.9	33.0
99 Saturn SL	61	0.37	22.9	36.4
99 Toyota PU Buck	59	0.65	30.2	31.3
99 Intrepid Buck	10	0.57	40.0	47.3
99 Acura RL	40	0.62	26.4	29.0
99 Expedition	9	0.34	32.2	37.0
99 Average	31	0.47	29.4	35.7

Passenger Air Bag Test Data

Table D-3. Results for Passenger Side Out-of-Position Testing with 6-Year-Old Child Dummy--Position 1					
Model	Distance	15 ms HIC	MaxNij	Chest Acceleration (Gs)	Chest Deflection (mm)
IARV		700	1.00	60.0	40.0
99 Acura RL	0	101	1.26	19.5	10.7
99 Acura RL	0	87	0.91	19.4	6.9
99 Intrepid	0	149	2.78	58.9	42.1
99 Econoline	0	428	2.66	50.3	45.1
99 Expedition	0	42	1.02	39.2	49.8
99 Saturn	0	35	0.89	23.1	44.2
99 Tacoma PU	0	145	3.31	17.9	21.9
Average		141	1.83	32.6	31.5
98 Accord	0	132	2.05	37.0	40.1
98 Camry	0	213	3.64	32.8	11.3
98 Caravan	0	493	3.30	30.7	50.6
98 Explorer	0	210	5.91	50.2	50.2
98 Neon	0	172	2.65	22.3	41.8
98 Taurus	0	1854	2.81	64.0	50.5
Average		512	3.39	39.5	40.7
96 Camry	0	1020	8.67	64.6	45.4
96 Caravan	0	1207	NA	82.9	50.0
96 Explorer	0	276	2.91	42.5	63.0
96 Explorer	0	278	3.58	37.5	60.2
96 Neon	0	377	3.13	35.7	43.8
96 Taurus	0	2471	3.69	53.8	28.0
Average		938	4.40	52.9	48.4
98 Accord	4	142	1.53	28.1	27.4
98 Camry	4	1436	1.27	38.4	7.5
98 Caravan	4	91	0.69	32.9	25.2
98 Explorer	4	16	0.40	16.7	35.2
98 Neon	4	176	2.39	28.0	21.6
98 Taurus	4	1431	2.21	32.5	15.1
Average		549	1.42	29.4	22.0
96 Camry	4	1131	6.22	54.8	38.6
96 Caravan	4	697	1.36	50.9	49.6
96 Explorer	4	300	2.62	34.0	41.7
96 Explorer	4	375	1.67	54.0	53.0
96 Neon	4	236	3.19	27.5	30.2
96 Taurus	4	525	2.09	18.4	9.9
Average		544	2.86	39.9	37.2

Table D-3. Results for Passenger Side Out-of-Position Testing with 6-Year-Old Child Dummy--Position 1					
Model	Distance	15 ms HIC	MaxNij	Chest Acceleration (Gs)	Chest Deflection (mm)
IARV		700	1.00	60.0	40.0
98 Accord	8	66	0.92	16.0	19.7
98 Camry	8	395	2.31	28.1	30.4
98 Caravan	8	77	0.87	30.0	13.2
98 Explorer	8	73	0.86	20.2	11.9
98 Neon	8	495	0.70	16.2	10.0
98 Taurus	8	250	0.60	20.0	8.7
Average		226	1.04	21.8	15.7
96 Camry	8	656	3.09	42.1	N/A
96 Caravan	8	480	1.04	53.7	32.8
96 Explorer	8	111	0.86	25.6	40.3
96 Neon	8	873	2.35	25.2	24.1
96 Taurus	8	321	0.62	20.9	5.4
Average		488	1.59	33.5	25.7

Table D-4. Results for Passenger Side Out-of-Position Testing with 6-Year-Old Child Dummy--Position 2					
Model	Distance	15 ms HIC	MaxNij	Chest Acceleration (Gs)	Chest Deflection (mm)
IARV		700.0	1.00	60.0	40.0
99 Acura RL	0	101	0.83	17.7	3.0
99 Acura RL	0	113	0.94	16.0	9.0
99 Intrepid	0	627	3.27	68.8	39.7
99 Expedition	0	131	2.27	85.5	45.0
99 Econoline	0	429	2.22	65.0	34.3
99 Saturn	0	76	1.97	44.6	43.4
99 Tacoma PU	0	246	2.54	41.0	18.3
Average		246	2.01	48.4	27.5

30 MPH Rigid Barrier Testing

Driver Air Bag Test Results

The test results for the 50th percentile male driver dummy are found in Figures D-3 through D-7. The driver dummy in the MY 1999 Acura RL exceeded the maximum femur load requirement. This was the only IARV exceeded for the driver dummy in these tests. It should be noted that the injury measures for the chest displacement, head injury criterion, and neck injury criterion were below 90 percent of the IARVs for each of the thirteen tested vehicles, with most below the 80 percent level. However, for chest Gs, two vehicles (i.e., the MY 1999 Dodge Intrepid and Acura RL) were within 90 to 100 percent of the IARV.

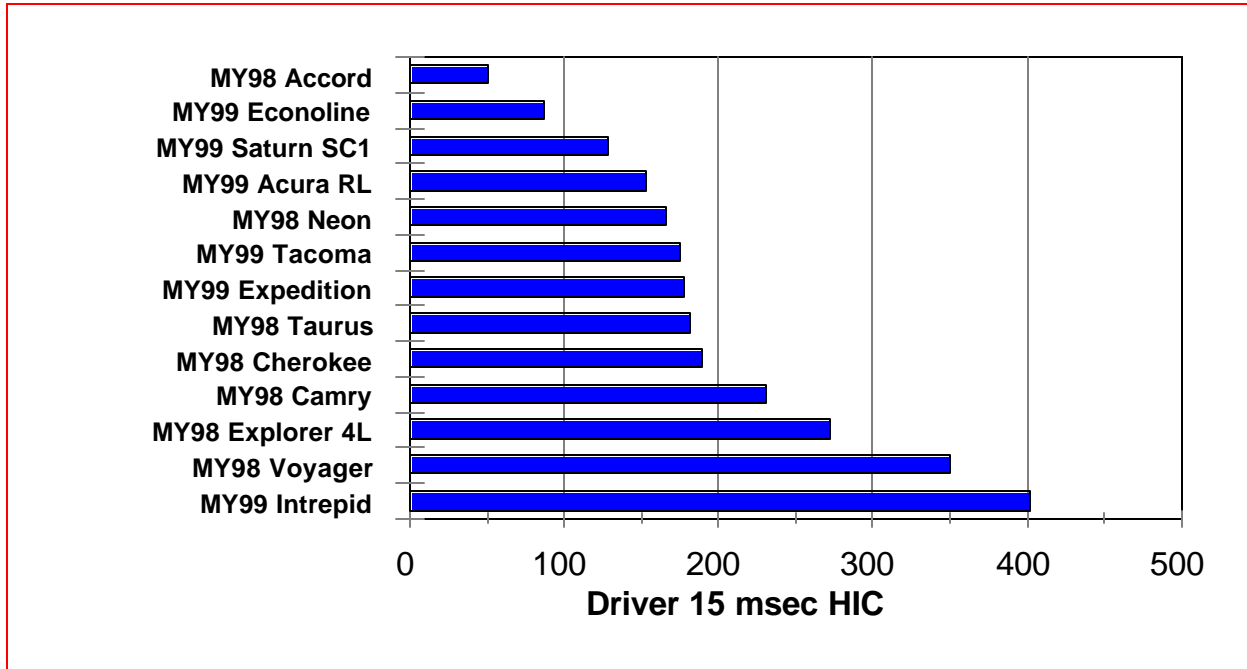

Figure D-3. Driver Head Injury Criterion in 30 mph Unbelted Barrier Test.

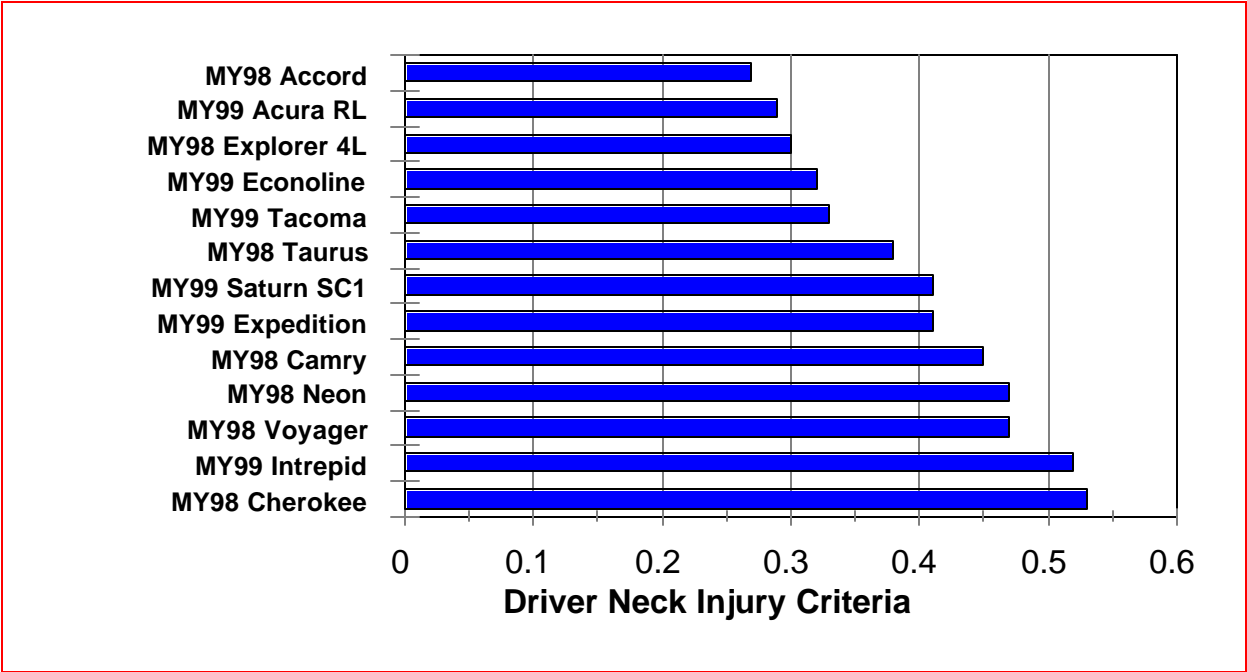

Figure D-4. Driver Neck Injury Criteria in 30 mph Unbelted Barrier Test.

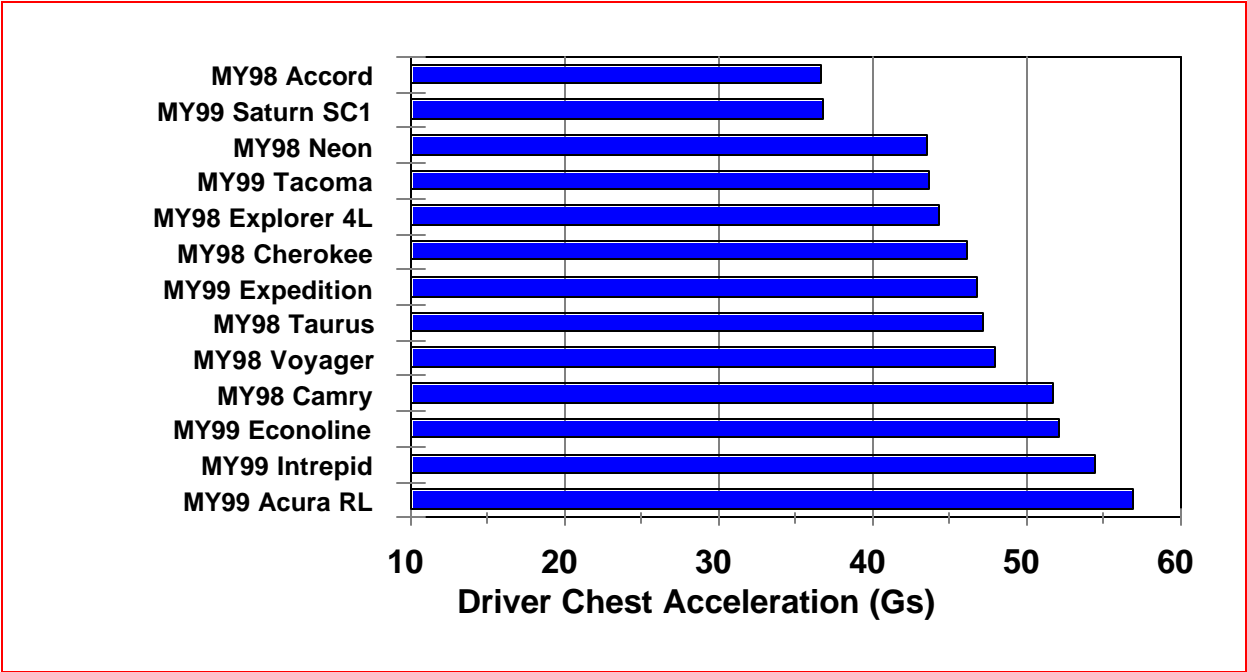

Figure D-5. Driver Chest Acceleration in 30 mph Unbelted Barrier Test.

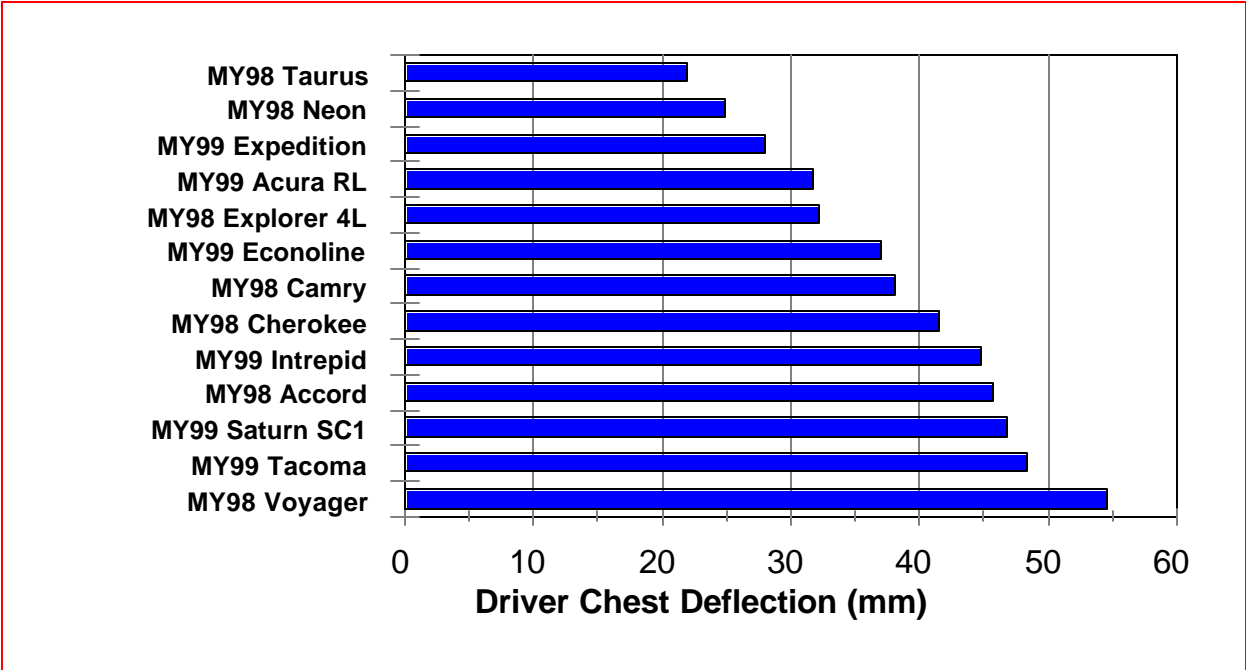

Figure D-6. Driver Chest Deflection in 30 mph Unbelted Barrier Test.

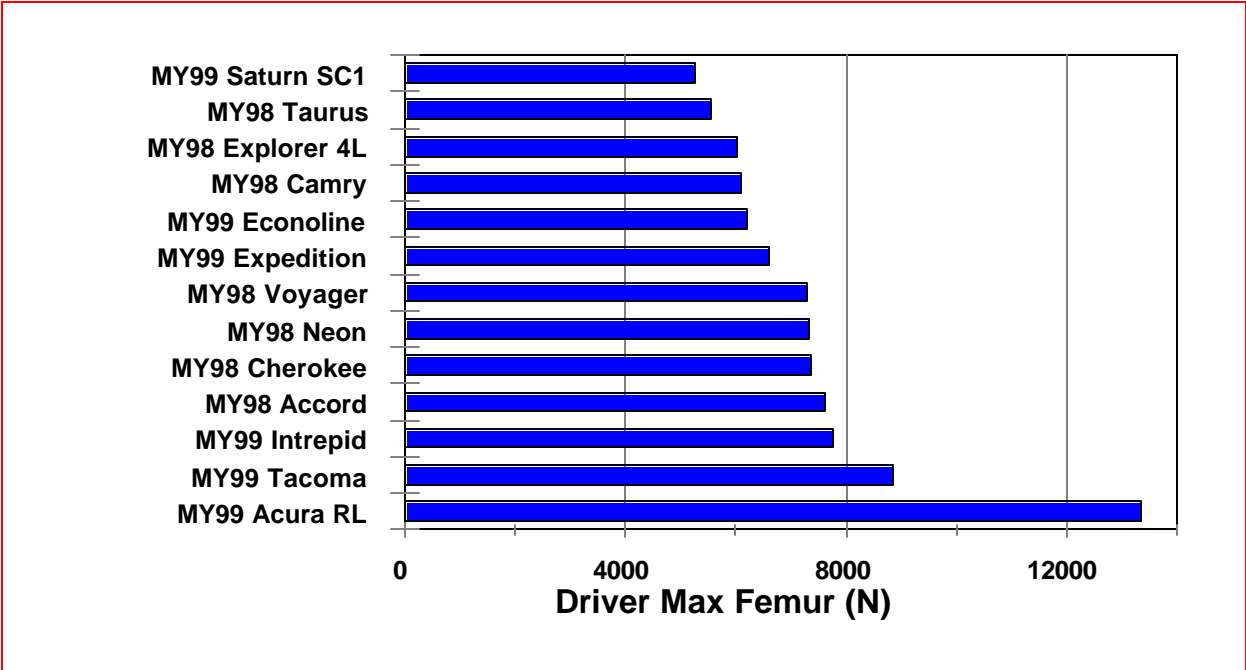

Figure D-7. Driver Maximum Femur Load in 30 mph Unbelted Barrier Test.

Passenger Air Bag Test Results

The test results for the 50th percentile male passenger dummy are found in Figures D-8 through D-12. The passenger dummy in the MY 1998 Dodge Neon exceeded the IARV for chest Gs. This was the only IARV exceeded for the passenger dummy in these tests. The injury measures for the chest displacement, head injury criterion, neck injury criterion, and femur load requirement were all below 90 percent of the IARVs for each of the thirteen tested vehicles, again with most below the 80 percent level. However, for chest Gs, one vehicle (i.e., the MY 1999 Dodge Intrepid) was within 90 to 100 percent of the IARV.

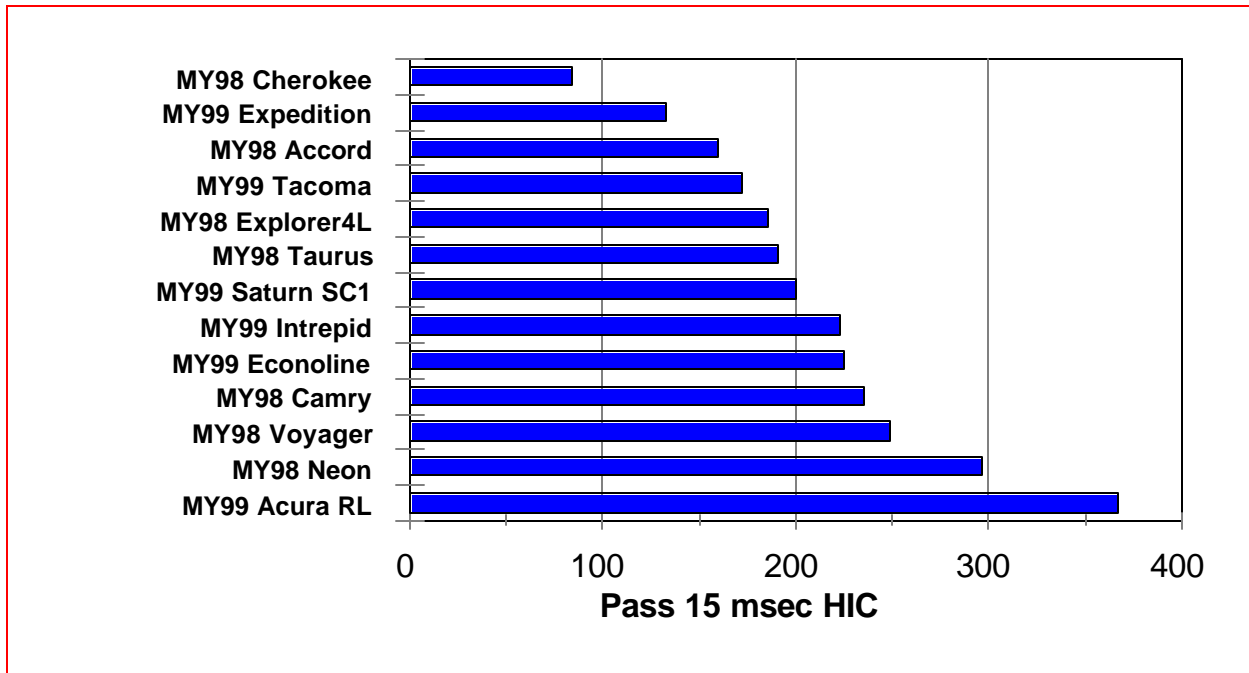

Figure D-8. Passenger Head Injury Criterion in 30 mph Unbelted Barrier Test.

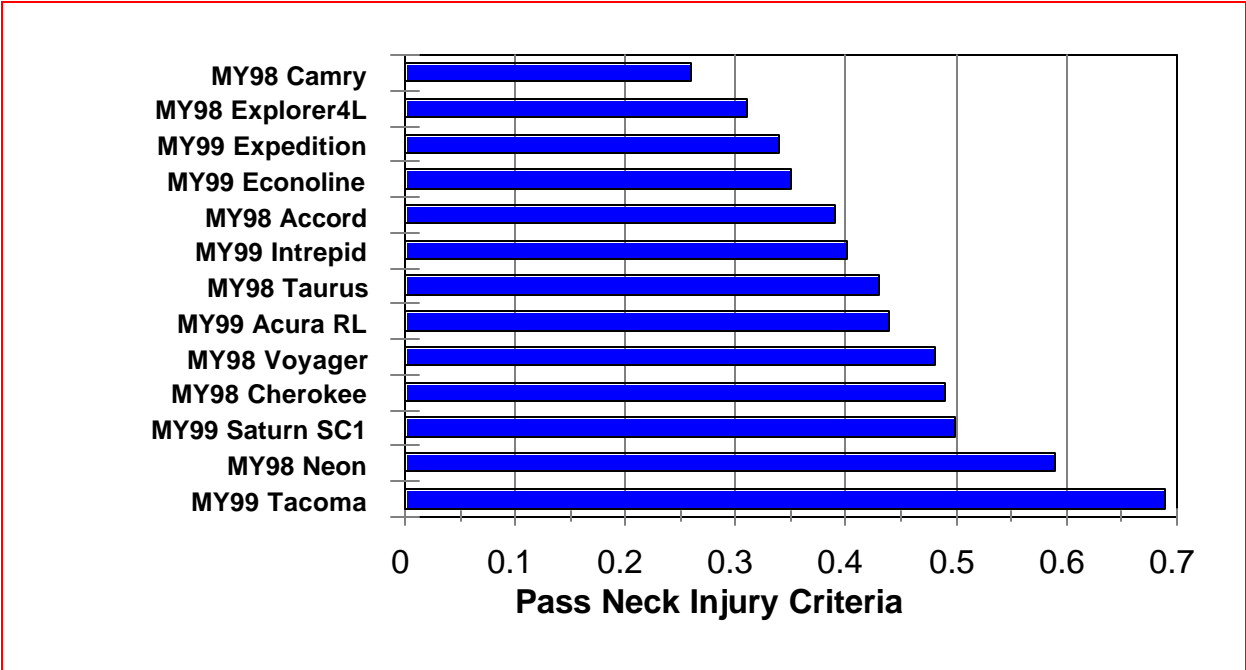

Figure D-9. Passenger Neck Injury Criteria in 30 mph Unbelted Barrier Test.

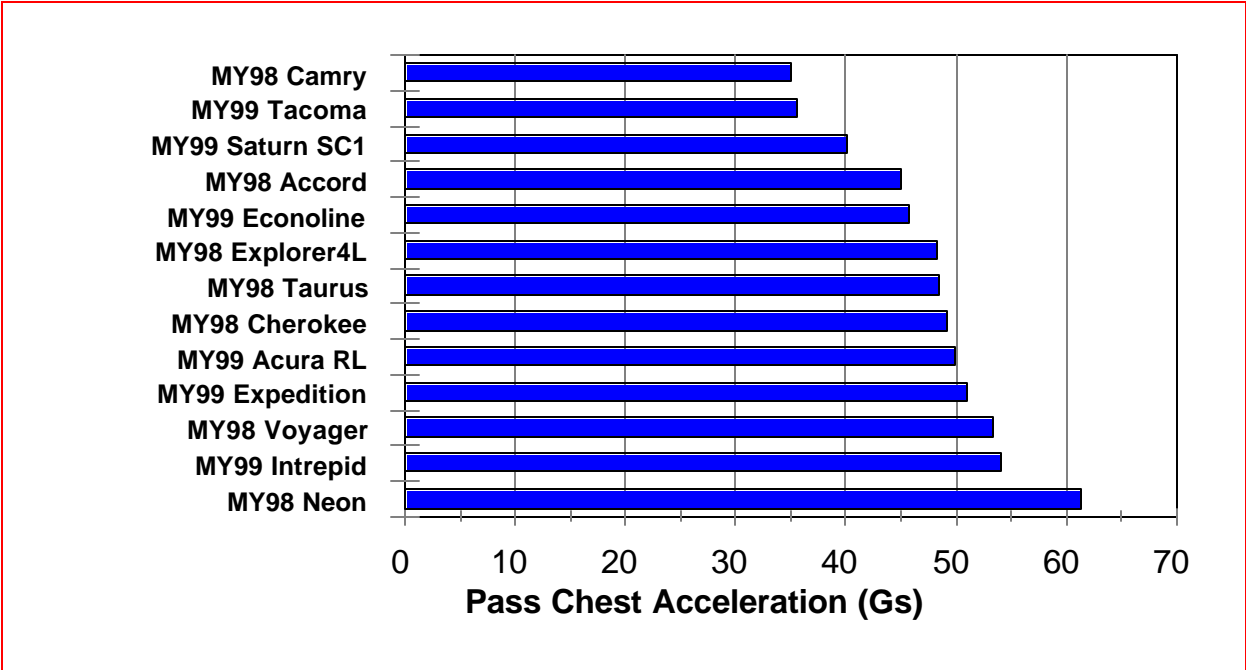

Figure D-10. Passenger Chest Acceleration in 30 mph Unbelted Barrier Test.

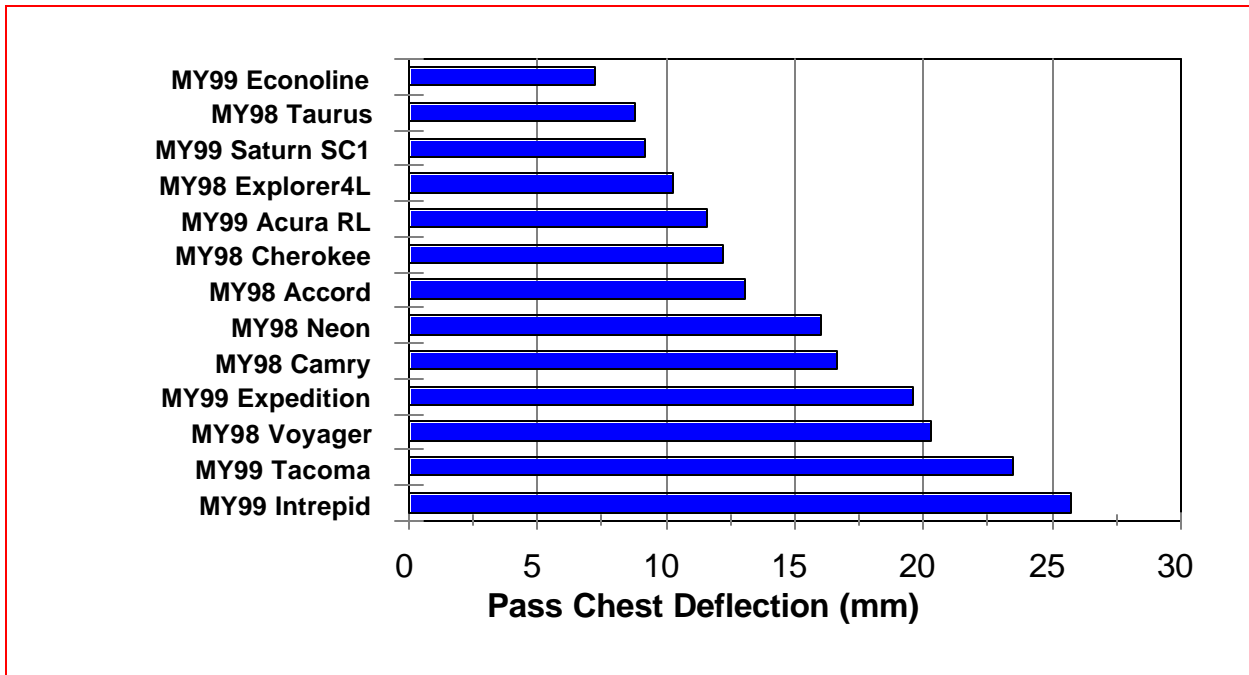

Figure D-11. Passenger Chest Deflection in 30 mph Unbelted Barrier Test.

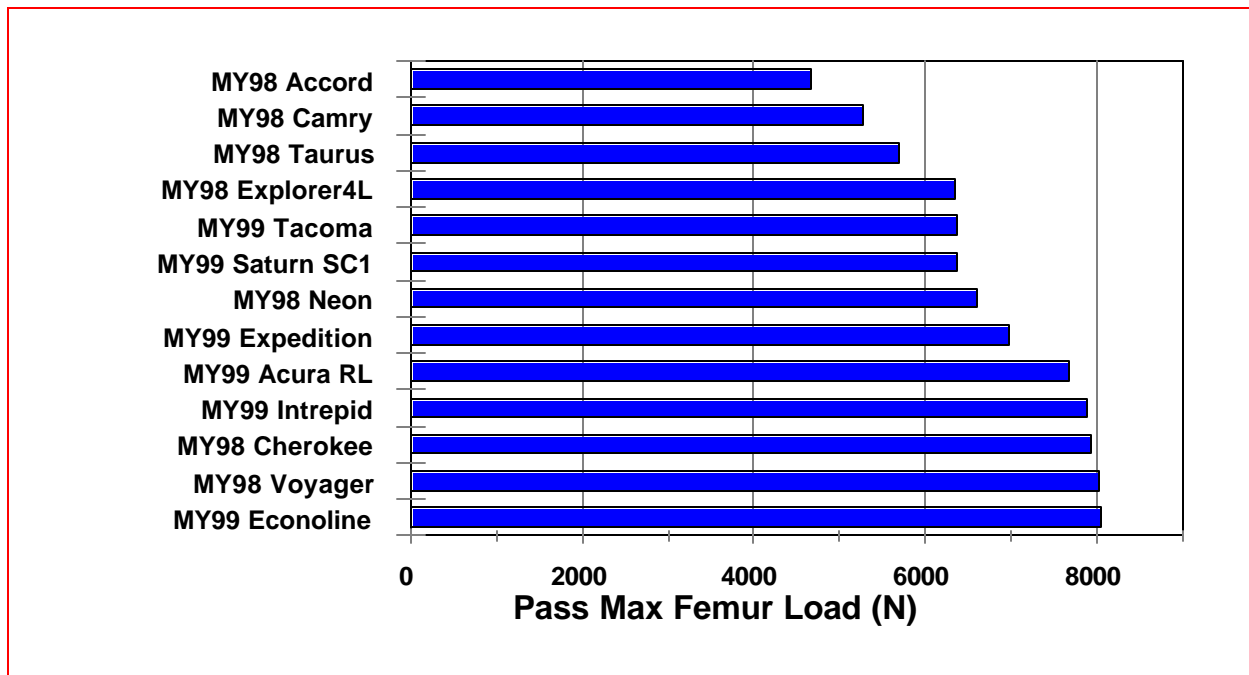

Figure D-12. Passenger Maximum Femur Load in 30 mph Unbelted Barrier Test.

Driver and Passenger 30 MPH Unbelted Rigid Barrier Test Data for MY 1998 and 1999 Vehicles

TABLE D-5. Unbelted Driver 50th Percentile Male.							
		Test #	Chest G IARV = 60.0	Chest disp. IARV = 63.0 mm	HIC15 IARV = 700	Nij ver. 9 IARV = 1.0	Maximum Femur (N) IARV = 10,008 N
30 mph Rigid Barrier	MY99 Intrepid	V3126	54.4	44.8	403	0.52	7,786 (R)
	MY99 Tacoma	V3128	43.7	48.4	176	0.33	8,839 (L)
	MY99 Acura RL	V3125	56.9	31.8	154	0.29	13,349 (L)
	MY99 Saturn SC1	V3127	36.8	46.8	128	0.41	5,288 (R)
	MY99 Econoline	V3123	52.1	37.1	87	0.32	6,198 (L)
	MY99 Expedition	V3124	46.7	28.1	178	0.41	6,612 (R)
	MY99 Average		48.4	39.5	207	0.38	8,012
	MY98 Taurus	V2832	47.2	21.9	181	0.38	5,556 (L)
	MY98 Neon	V2838	43.5	24.9	166	0.47	7,336 (R)
	MY98 Camry	V2837	51.8	38.1	231	0.45	6,115 (L)
	MY98 Accord	V2836	36.7	45.8	51	0.27	7,623 (R)
	MY98 Explorer 4L	V2839	44.4	32.3	272	0.30	6,033 (R)
	MY98 Voyager	V2773	48.0	54.7	350	0.47	7,309 (L)
	MY98 Cherokee	V2830	46.1	41.6	189	0.53	7,366 (L)
	MY98 Average		45.4	37.0	205	0.41	6,763

Table D-6. Unbelted Passenger 50th Percentile Male.

		Test #	Chest G IARV = 60.0	Chest disp. (mm) IARV = 63.0 mm	HIC15 IARV = 700	Nij ver. 9 IARV 1.0	Maximum Femur (N) IARV = 10,008 N
30 mph Rigid Barrier	MY99 Intrepid	V3126	54.1	25.7	223	0.40	7,890 (R)
	MY99 Tacoma	V3128	35.6	23.5	173	0.69	6,372 (R)
	MY99 Acura RL	V3125	49.8	11.6	367	0.44	7,676 (R)
	MY99 Saturn SC1	V3127	40.2	9.2	200	0.50	6,374 (L)
	MY99 Econoline	V3123	45.8	7.3	226	0.35	8,039 (R)
	MY99 Expedition	V3124	51.0	19.6	132	0.34	6,975 (R)
	MY99 Average		46.1	20.1	220	0.57	7,221
	MY98 Taurus	V2832	48.5	8.8	191	0.43	5,697 (L)
	MY98 Neon	V2838	61.4	16.0	297	0.59	6,606 (L)
	MY98 Camry	V2837	35.1	16.7	236	0.26	5,273 (R)
	MY98 Accord	V2836	45.0	13.1	160	0.39	4,677 (L)
	MY98 Explorer4L	V2839	48.2	10.3	186	0.31	6,341 (R)
	MY98 Voyager	V2773	53.4	20.3	249	0.48	8,025 (R)
	MY98 Cherokee	V2830	49.2	12.2	84	0.49	7,921 (R)
	MY98 Average		48.7	13.9	200	0.46	6,363

Appendix E. SCI Supporting Data

SPECIAL CRASH INVESTIGATIONS
 NORMALIZED RATE OF SCI FATALITIES
 FATAL DRIVERS
 Confirmed and Unconfirmed
September 1, 1999

	Vehicle Model Year (in millions of vehicles)												Total	
	1988	1989	1990	1991	1992	1993	1994	1995	1996	1997	1998	1999		
New Registered Driver Air Bag Equipped Vehicles	0.246	0.802	2.756	3.183	4.395	5.709	10.820	12.459	13.556	15.063	15.843	15.484	100.316	

Crash Date	Vehicle Model Year												Total	Fatalities/ Million Vehicle Years	
	1988	1989	1990	1991	1992	1993	1994	1995	1996	1997	1998	1999			
Sep 87 to Aug 88													0	0.000	87-88
Sep 88 to Aug 89													0	0.000	88-89
Sep 89 to Aug 90			1										1	0.263	89-90
Sep 90 to Aug 91			1	3									4	0.572	90-91
Sep 91 to Aug 92				1									1	0.088	91-92
Sep 92 to Aug 93			1	2	1								4	0.234	92-93
Sep 93 to Aug 94			1	2	1		3						7	0.251	93-94
Sep 94 to Aug 95			3	1									4	0.099	94-95
Sep 95 to Aug 96		1			1		2	1					5	0.093	95-96
Sep 96 to Aug 97				1	1	3	5		5	3			18	0.261	96-97
Sep 97 to Aug 98	1			2	1	1	2	4	3	1			15	0.177	97-98
Sep 98 to Aug 99				1		1				1	2		5	0.050	98-99
Sep 99 to Aug 2000															
Total	1	1	7	13	5	5	12	5	8	5	2	0	64		
Fatalities/Million Vehicle Years	0.339	0.113	0.254	0.454	0.142	0.125	0.185	0.080	0.148	0.111	0.063	0.000			

SPECIAL CRASH INVESTIGATIONS
 NORMALIZED RATE OF SCI FATALITIES
 FATAL PASSENGERS
 Confirmed and Unconfirmed
September 1, 1999

	Vehicle Model Year (in millions of vehicles)												Total
	1988	1989	1990	1991	1992	1993	1994	1995	1996	1997	1998	1999	
New Registered Driver Air Bag Equipped Vehicles	0.000	0.090	0.120	0.080	0.510	1.820	5.590	9.200	9.840	13.270	15.010	15.010	70.540

Crash Date	Vehicle Model Year												Total	Fatalities/ Million Vehicle Years	Total RFCSS	Fata/Year / Millions of Air Bags	Fata/Year/ Millions of Air Bags	
	1988	1989	1990	1991	1992	1993	1994	1995	1996	1997	1998	1999						
Sep 87 to Aug 88													0	0.000	0	0.000	0.000	87-88
Sep 88 to Aug 89													0	0.000	0	0.000	0.000	88-89
Sep 89 to Aug 90													0	0.000	0	0.000	0.000	89-90
Sep 90 to Aug 91													0	0.000	0	0.000	0.000	90-91
Sep 91 to Aug 92													0	0.000	0	0.000	0.000	91-92
Sep 92 to Aug 93						1							1	0.382	0	0.000	0.382	92-93
Sep 93 to Aug 94						1	1						2	0.244	0	0.000	0.244	93-94
Sep 94 to Aug 95						1	2	5					8	0.460	1	0.057	0.402	94-95
Sep 95 to Aug 96							7	11	2				20	0.734	6	0.220	0.514	95-96
Sep 96 to Aug 97							4	13	9	6			32	0.790	6	0.148	0.642	96-97
Sep 97 to Aug 98					1		6	15	4	8	1		35	0.630	4	0.072	0.558	97-98
Sep 98 to Aug 99							1	6	1	3	2	2	15	0.213	0	0.000	0.213	98-99
Sep 99 to Aug 2000																		
Total	0	0	0	0	1	3	21	50	16	17	3	2	113		17			
Fatalities/Million Vehicle Years	0.000	0.000	0.000	0.000	0.245	0.235	0.626	1.087	0.407	0.427	0.100	0.266						
Total RFCSS	0	0	0	0	0	0	3	10	2	2	0	0			17			
Fatalities/Million Vehicle Years	0.000	0.000	0.000	0.000	0.000	0.000	0.089	0.217	0.051	0.050	0.000	0.000						
Fatalities/Million Vehicle Years	0.000	0.000	0.000	0.000	0.245	0.235	0.537	0.870	0.356	0.377	0.100	0.266						